



AATCC TECHNICAL MANUAL

AATCC takes no position respecting the validity of any patent rights asserted in connection with any item mentioned in these test methods and evaluation procedures. Users of the AATCC Technical Manual are expressly advised that determination of the validity of any such patent rights, and the risk of infringement of such rights, are entirely their own responsibility.

The test methods in the AATCC Technical Manual are subject to revision at any time by the responsible technical committee and must be reviewed every five years and, if not revised, either reaffirmed or withdrawn. Your comments are invited either for revision of current methods in this technical manual or for additional methods and should be addressed to the AATCC Technical Center. Your comments will receive careful consideration at a meeting of the responsible technical committee, which you may attend. If you feel that your comments have not received a fair hearing, you should make your views known to Amy G. Hammonds, Laboratory Director, at the address shown below.

The AATCC Technical Manual is copyrighted by AATCC, P.O. Box 12215, Research Triangle Park, NC 27709 USA. Individual reprints (single or multiple copies) of any method may be obtained by contacting AATCC at the above address or tel: 919-549-3526; fax: 919-549-8933, e-mail: orders@aatcc.org, or online at www.aatcc.org.

AATCC License Agreement: The AATCC Technical Manual is copyrighted by the American Association of Textile Chemists and Colorists (AATCC), P.O. Box 12215, 1 Davis Drive, Research Triangle Park, NC USA. All rights reserved.

AATCC grants you a license as follows: The right to download an electronic file from this AATCC Technical Manual for storage on one computer for purposes of viewing, and/or printing one copy of any AATCC Test Method for individual use for one year. Neither the electronic file nor the hard copy print may be reproduced in any way. In addition, the electronic file may not be distributed elsewhere over computer networks or otherwise. The hard copy print may only be distributed to other employees for their internal use within your organization.

This AATCC Technical Manual is not for resale.

AMERICAN ASSOCIATION OF TEXTILE CHEMISTS AND COLORISTS

P.O. Box 12215, Research Triangle Park, NC 27709, USA

Tel: 919/549-8141; Fax: 919/549-8933

Web Site: <http://www.aatcc.org>

Copyright © 2005 American Association of Textile Chemists and Colorists

Library of Congress Catalog Number: 54-34349

Copyright Permission: AATCC has contracted with Copyright Clearance Center Inc. (CCC) such that permission requests to photocopy or otherwise reproduce copyrighted material owned by AATCC for internal or personal use beyond the fair use provision of the Copyright Act should be submitted to CCC; Web site www.copyright.com; e-mail info@copyright.com; telephone 978-750-8400; fax 978-750-4470. Copying for other than internal or personal use without express permission of AATCC is prohibited. Address requests for customized bulk reprints to AATCC Bulk Reprints, P.O. Box 12215, Research Triangle Park, NC 27709-2215, telephone 919/549-8141; fax 919/549-8933.

Copyright © 2005 American Association of Textile Chemists and Colorists

Navigation Tips

All bookmarks (on the left side of your screen) are links that will take you directly to the list of test methods (move your mouse over a bookmark and click once). All **blue** text in this document is a direct link to the referenced text. To access a method or document, simply point to it with your mouse and click once. To return to the Table of Contents or a specific list, click on one of the bookmarks on the left.

Table of Contents

Index of Test Methods	
Numerical Listing.....	5
Alphabetical Listing.....	9
Topical Listing.....	11
Changes in Test Methods Since Last Edition	14
Test Methods.....	16
Evaluation Procedures	379
Special Equipment and Materials	402
Monographs	
1993 AATCC Standard Reference Detergent and Laundry Detergents in General	404
2003 AATCC Standard Reference Liquid Laundry Detergent.....	406
Standardization of Home Laundry Test Conditions.....	408
Standard Laboratory Practice for Home Laundering Fabrics Prior to Flammability Testing to Differentiate Between Durable and Non-Durable Finishes	410
Nomenclature for Subjective Rating Processes	411
A Summary of ASTM Methods for Interlaboratory Testing.....	412
A Glossary of AATCC Standard Terminology.....	414
AATCC Style Guide for Writing Test Methods.....	423
Rules of Procedure for AATCC Test Method and Technology Committees	430
AATCC Board of Directors and Administrative Committees.....	438
Research Committees	442
Reference Committees.....	452
AATCC Representatives on Committees of Other Organizations.....	453
Joint Report ECR/TCR	454
Reports of Research Committees.....	459
Roster of Corporate Members.....	461

Preface

THE test methods in this edition of the TECHNICAL MANUAL were current as of May 2004. New methods that have been added and other important changes made since the last issue are summarized on page 14.

AATCC test methods are developed by research committees through extensive investigations and interlaboratory comparisons, often covering several years of work. Simplicity, reproducibility, applicability, cost of performing the test and the time required to perform the test are all important considerations in each development. Before a method is published in the TECHNICAL MANUAL, it must be approved by the responsible research committee, reviewed by the Editorial Committee and approved by the Technical Committee on Research (TCR).

During the first three years, each new test method is reviewed annually, at which time, on recommendation of the research committee and approval by TCR, it may be reaffirmed, revised or withdrawn. After the first three years, each method is reviewed at least once every five years by the research committee, and following approval by TCR may be reaffirmed, revised or withdrawn. The historical record of these actions is published in a foreword to each method.

An important feature of all AATCC test methods is that test results are numerically quantified as opposed to being reported as pass-fail. Test results are the basis for describing material or process characteristics that are not in themselves intended to be performance specifications. AATCC policy prohibits endorsement of such specifications.

Each test method is designated by a number followed by a date which indicates the year in which the method was issued, last revised or reaffirmed. The designation should be quoted in full in referring to a particular method. If the source of the method is not clear from the context of the reference, the designation should be preceded by AATCC, as for example, AATCC Test Method 16-2004, or simply AATCC 16-2004.

The *AATCC Style Guide for Writing Test Methods* (page 419) is the defining document used by research committees in writing these methods. The *Rules of Procedure for AATCC Test Method and Technology Committees* (page 426) is the defining document for the organization and functioning of these research committees.

Prior to 1969 the TECHNICAL MANUAL contained all the material published in three separate books—the TECHNICAL MANUAL, the July issue of *Textile Chemist and Colorist* (Buyer's Guide), now *AATCC Review*, and the AATCC MEMBERSHIP DIRECTORY. The present format for the TECHNICAL MANUAL has continued unchanged since 1969. Major changes in layout of the Technical Manual were made in 1985 as follows: (1) indexes were grouped at the front of the book; (2) test methods were arranged in numerical order; (3) the *Glossary of Standard Terminology* was added and (4) the *Style Guide for Writing Test Methods* was added. In 1989 Evaluation Procedures were listed immediately after the test methods.

EDITORIAL COMMITTEE
Adi B. Chehna, Chair
Nikhil Agrawal
Leander B. Ricard
Genevieve M. Smith
Adam R. Varley

Numerical List of Current AATCC Test Methods and Procedures

Method	Committee	Test Method	Page
6-2001	RR1	Colorfastness to Acids and Alkalis	16
8-2005	RA38	Colorfastness to Crocking: AATCC Crockmeter Method	17
15-2002	RR52	Colorfastness to Perspiration.....	20
16-2004	RA50	Colorfastness to Light	23
17-2005	RA63	Wetting Agents, Evaluation of	35
20-2005	RA24	Fiber Analysis: Qualitative.....	38
20A-2005	RA24	Fiber Analysis: Quantitative.....	57
22-2005	RA63	Water Repellency: Spray Test	65
23-2005	RA33	Colorfastness to Burnt Gas Fumes	68
24-2004	RA31	Insects, Resistance of Textiles to.....	71
26-2004	RR9	Ageing of Sulfur-Dyed Textiles: Accelerated.....	76
27-2004	RA63	Wetting Agents: Evaluation of Rewetting Agents	78
28-2004	RA31	Insect Pest Deterrents on Textiles	79
30-2004	RA31	Antifungal Activity, Assessment on Textile Materials: Mildew and Rot Resistance of Textile Materials	81
35-2000	RA63	Water Resistance: Rain Test	85
42-2000	RA63	Water Resistance: Impact Penetration Test	87
43-2004	RA63	Wetting Agents for Mercerization	89
61-2003	RA60	Colorfastness to Laundering, Home and Commercial: Accelerated	90
66-2003	RA61	Wrinkle Recovery of Woven Fabrics: Recovery Angle.....	95
70-2005	RA63	Water Repellency: Tumble Jar Dynamic Absorption Test.....	99
76-2005	RA32	Electrical Surface Resistivity of Fabrics	101
79-2000	RA63	Absorbency of Bleached Textiles	103
81-2001	RA34	pH of the Water-Extract from Wet Processed Textiles	105
82-2001	RA34	Fluidity of Dispersions of Cellulose from Bleached Cotton Cloth.....	106
84-2005	RA32	Electrical Resistance of Yarns	110
86-2005	RA43	Drycleaning: Durability of Applied Designs and Finishes	112
88B-2003	RA61	Smoothness of Seams in Fabrics after Repeated Home Laundering	114
88C-2003	RA61	Retention of Creases in Fabrics after Repeated Home Laundering.....	118
89-2003	RA66	Mercerization in Cotton.....	122
92-2004	RR35	Chlorine, Retained, Tensile Loss: Single Sample Method	124
93-2005	RA29	Abrasion Resistance of Fabrics: Accelerator Method	127
94-2002	RR45	Finishes in Textiles: Identification	130
96-2004	RA42	Dimensional Changes in Commercial Laundering of Woven and Knitted Fabrics Except Wool	137
97-1999	RA34	Extractable Content of Greige and/or Prepared Textiles	141
98-2002	RA34	Alkali in Bleach Baths Containing Hydrogen Peroxide	143
99-2004	RA42	Dimensional Changes of Woven or Knitted Wool Textiles: Relaxation, Consolidation and Felting	145
100-2004	RA31	Antibacterial Finishes on Textile Materials: Assessment of.....	149
101-2004	RA34	Colorfastness to Bleaching with Hydrogen Peroxide	152
102-2002	RA34	Hydrogen Peroxide by Potassium Permanganate Titration: Determination of	155
103-2004	RA34	Bacterial Alpha-Amylase Enzymes used in Desizing, Assay of	157
104-2004	RA23	Colorfastness to Water Spotting	160
106-2002	RA23	Colorfastness to Water: Sea.....	161
107-2002	RA23	Colorfastness to Water.....	163
109-2005	RA33	Colorfastness to Ozone in the Atmosphere under Low Humidities	165
110-2005	RA36	Whiteness of Textiles	167
111-2003	RA64	Weather Resistance of Textiles: Exposure to Daylight and Weather	169
112-2003	RR68	Formaldehyde Release from Fabric, Determination of: Sealed Jar Method	178
114-2005	RR35	Chlorine, Retained, Tensile Loss: Multiple Sample Method.....	181
115-2005	RA32	Electrostatic Clinging of Fabrics: Fabric-to-Metal Test	183
116-2005	RA38	Colorfastness to Crocking: Rotary Vertical Crockmeter Method	187
117-2004	RR54	Colorfastness to Heat: Dry (Excluding Pressing)	189
118-2002	RA56	Oil Repellency: Hydrocarbon Resistance Test.....	191
119-2004	RA29	Color Change Due to Flat Abrasion (Frosting): Screen Wire Method	194
120-2004	RA29	Color Change Due to Flat Abrasion (Frosting): Emery Method	197
121-2005	RA57	Carpet Soiling: Visual Rating Method	199
122-2000	RA57	Carpet Soiling: Service Soiling Method	201
123-2000	RA57	Carpet Soiling: Accelerated Soiling Method	203
124-2005	RA61	Appearance of Fabrics after Repeated Home Laundering.....	205

Method	Committee	Test Method	Page
125-2004	RA50	Colorfastness to Perspiration and Light	209
127-2003	RA63	Water Resistance: Hydrostatic Pressure Test	211
128-2004	RA61	Wrinkle Recovery of Fabrics: Appearance Method.....	213
129-2005	RA33	Colorfastness to Ozone in the Atmosphere under High Humidities.....	215
130-2000	RA56	Soil Release: Oily Stain Release Method.....	217
131-2005	RR53	Colorfastness to Pleating: Steam Pleating.....	220
132-2004	RA43	Colorfastness to Drycleaning	222
133-2004	RR54	Colorfastness to Heat: Hot Pressing.....	225
134-2001	RA32	Electrostatic Propensity of Carpets	227
135-2004	RA42	Dimensional Changes of Fabrics after Home Laundering.....	231
136-2003	RA79	Bond Strength of Bonded and Laminated Fabrics	235
137-2002	RA57	Rug Back Staining on Vinyl Tile.....	238
138-2005	RA57	Cleaning: Washing of Textile Floor Coverings.....	240
139-2005	RA50	Colorfastness to Light: Detection of Photochromism.....	242
140-2001	RA87	Dye and Pigment Migration in a Pad-Dry Process: Evaluation of	244
141-2004	RA87	Compatibility of Basic Dyes for Acrylic Fibers	247
142-2005	RR81	Appearance of Flocked Fabrics after Repeated Home Laundering and/or Coin-Op Drycleaning.....	249
143-2001	RA61	Appearance of Apparel and Other Textile End Products after Repeated Home Laundering.....	252
144-2002	RA34	Alkali in Wet Processed Textiles: Total	258
146-2001	RA87	Dispersibility of Disperse Dyes: Filter Test	260
147-2004	RA31	Antibacterial Activity Assessment of Textile Materials: Parallel Streak Method.....	263
149-2002	RA90	Chelating Agents: Chelation Value of Aminopolycarboxylic Acids and Their Salts; Calcium Oxalate Method	265
150-2003	RA42	Dimensional Changes of Garments after Home Laundering.....	267
151-2003	RA56	Soil Redeposition: Launder-Ometer Method	271
154-2001	RA87	Thermal Fixation Properties of Disperse Dyes.....	273
157-2005	RR92	Colorfastness to Solvent Spotting: Perchloroethylene.....	275
158-2005	RA43	Dimensional Changes on Drycleaning in Perchloroethylene: Machine Method	277
159-1999	RA87	Transfer of Acid and Premetallized Acid Dyes on Nylon	280
161-2002	RA90	Chelating Agents: Disperse Dye Shade Change Caused by Metals; Control of	282
162-2002	RA23	Colorfastness to Water: Chlorinated Pool	285
163-2002	RR92	Colorfastness: Dye Transfer in Storage; Fabric-to-Fabric	287
164-2001	RA33	Colorfastness to Oxides of Nitrogen in the Atmosphere under High Humidities.....	289
165-1999	RA57	Colorfastness to Crocking: Textile Floor Coverings—AATCC Crockmeter Method.....	291
167-2003	RA87	Foaming Propensity of Disperse Dyes.....	294
168-2002	RA90	Chelating Agents: Active Ingredient Content of Polyaminopolycarboxylic Acids and Their Salts; Copper PAN Method	296
169-2003	RA64	Weather Resistance of Textiles: Xenon Lamp Exposure	298
170-2001	RA87	Dusting Propensity of Powder Dyes: Evaluation of	304
171-2005	RA57	Carpets: Cleaning of; Hot Water Extraction Method	306
172-2003	RA60	Colorfastness to Non-Chlorine Bleach in Home Laundering.....	308
173-2005	RA36	CMC: Calculation of Small Color Differences for Acceptability	311
174-1998	RA31	Antimicrobial Activity Assessment of Carpets.....	316
175-2003	RA57	Stain Resistance: Pile Floor Coverings	319
176-2001	RA87	Speckiness of Colorant Dispersions: Evaluation of.....	322
178-2004	RR97	Barré: Visual Assessment and Grading.....	324
179-2004	RA42	Skewness Change in Fabric and Garment Twist Resulting from Automatic Home Laundering.....	327
181-2005	RA50	Colorfastness to Light at High Temperatures: Daylight Temperature and Humidity Controlled Apparatus.....	331
182-2005	RA36	Relative Color Strength of Dyes in Solutions	335
183-2004	RA106	Transmittance or Blocking of Erythemally Weighted Ultraviolet Radiation through Fabrics.....	338
184-2005	RA87	Dusting Behavior of Dyes: Determination of	342
185-2000	RA90	Chelating Agents: Percent Content in Hydrogen Peroxide Bleach Baths; Copper PAN Indicator Method	346
186-2001	RA64	Weather Resistance: UV Light and Moisture Exposure	348
187-2004	RA42	Dimensional Changes of Fabrics: Accelerated	353
188-2003	RA60	Colorfastness to Sodium Hypochlorite Bleach in Home Laundering	356
189-2002	RA57	Fluorine Content of Carpet Fibers.....	359
190-2003	RA60	Colorfastness to Home Laundering with Activated Oxygen Bleach Detergent: Accelerated.....	362
191-2004	RA41	Acid Cellulase Enzymes, Effect of: Top Loading Washer.....	365
192-2005	RA64	Weather Resistance of Textiles: Sunshine-Arc Lamp Exposure With and Without Wetting.....	367
193-2005	RA56	Aqueous Liquid Repellency: Water/Alcohol Solution Resistance Test.....	376

AATCC Evaluation Procedures

Procedure	Committee	Evaluation Procedure	
1 (2002)	RA36	Gray Scale for Color Change	379
2 (2005)	RA36	Gray Scale for Staining	381
4 (2002)	RA36	Standard Depth Scales for Depth Determination.....	383
5 (2001)	RR89	Fabric Hand: Guidelines for the Subjective Evaluation of.....	384
6 (2003)	RA36	Instrumental Color Measurement.....	386
7 (2003)	RA36	Instrumental Assessment of the Change in Color of a Test Specimen	392
8 (2002)	RA36	AATCC 9-Step Chromatic Transference Scale.....	394
9 (2002)	RA36	Visual Assessment of Color Difference of Textiles	396
10 (2005)	RA59	Evaluation of Multifiber Adjacent Fabrics	399

Discontinued AATCC Test Methods

Method	Committee	Test Method
1-1957	*D	Colorfastness to Washing, Mill Washing and Scouring: Wool Textiles.
2-1989	D	Colorfastness to Fulling.
3-1989	D	Colorfastness to Bleaching with Chlorine.
4-1957	D	Colorfastness to Washing, Mill: Silk Textiles.
5-1962	D	Colorfastness to Dry and Wet Heat. Superseded by Method 133.
7-1989	D	Colorfastness to Degumming.
9-1989	D	Colorfastness to Stoving.
10-1944	D	Colorfastness to Commercial Laundering and to Domestic Washing. Superseded by Method 36.
11-1989	D	Colorfastness to Carbonizing.
12-1931	D	Colorfastness to Sea Water. Superseded by Method 63.
13-1957	D	Colorfastness to Peroxide Bleaching with Peroxide: Silk. Superseded by Method 101.
14-1953	D	Dimensional Changes in Cotton and Linen Textiles. Superseded by Method 91.
16A-1988	D	Colorfastness to Light: Carbon-Arc Lamp, Continuous Light. Superseded by Method 16.
16B-1977	D	Colorfastness to Light through Glass: Sunlight.
16C-1988	D	Colorfastness to Light through Glass: Daylight. Superseded by Method 16.
16D-1988	D	Colorfastness to Light: Carbon-Arc Lamp, Alternate Light and Darkness. Superseded by Method 16.
16E-1987	D	Colorfastness to Light: Water-Cooled Xenon-Arc Lamp, Continuous Light. Superseded by Method 16.
16F-1988	D	Colorfastness to Light: Water-Cooled Xenon-Arc Lamp, Alternate Light and Darkness. Superseded by Method 16.
16G-1985	D	Colorfastness to Light: Determination of Fastness Above L-7. Superseded by Method 16.
18-1967	D	Water Resistance: Hydrostatic Pressure Test. Superseded by Method 127.
19-1937	D	Mercerization of Cotton, Determination of; Degree of. Superseded by Method 89.
21-1983	D	Water Repellency: Static Absorption Test.
25-1957	D	Colorfastness to Drycleaning. Superseded by Method 85.
29-1957	D	Colorfastness to Bleaching with Peroxide: Cotton and Linen. Superseded by Method 101.
31-1962	D	Colorfastness to Pleating. Superseded by Method 131.
32-1952	D	Detection of Phototropism. Superseded by Method 139.
33-1962	D	Flammability of Clothing Textiles.
34-1969	D	Fire Resistance of Textile Fabrics.
36-1972	D	Colorfastness to Washing: Characterization of Textile Colorants.
37-1952	D	Colorfastness to Commercial Laundering and Domestic Washing (Silk). Superseded by Method 36.
38-1952	D	Colorfastness to Commercial Laundering and Domestic Washing (Wool). Superseded by Method 36.
39-1980	D	Wettability, Evaluation of.
40-1957	D	Dimensional Changes in Textiles Other Than Wool. Superseded by Method 91.
41-1952	D	Dimensional Changes in Wool Textiles: Accelerated Test. Superseded by Method 99.
44	D	Discontinued. Superseded by Method 54.
45	D	Discontinued. Superseded by Method 54.
46	D	Discontinued. Superseded by Method 63.
47-1950	D	Colorfastness to Water (Other than Silk and Wool). Superseded by Method 63.
48-1952	D	Colorfastness to Water Spotting. Superseded by Method 104.

*Discontinued Method.

Method	Committee	Test Method
49-1952	D	Colorfastness to Chlorination. Superseded by Method 3.
50-1952	D	Colorfastness to Soda Boil.
51-1952	D	Colorfastness to Mercerizing.
52-1952	D	Colorfastness to Decatizing.
53-1952	D	Colorfastness to Chrome (Dichromate) in the Dye bath.
54-1952	D	Colorfastness to Cross Dyeing.
55-1952	D	Colorfastness to Potting.
56-1952	D	Colorfastness to Cellulose Ester Bonding.
57-1952	D	Colorfastness to Storage (Acetate).
58-1952	D	Colorfastness to Steaming (Acetate).
59-1952	D	Colorfastness to Peroxide Bleaching (Wool). Superseded by Method 13.
60-1952	D	Detergents on Wool: Detergency Comparator Method.
62-1989	D	Oils, Wool; Oxidation in Storage.
63-1961	D	Colorfastness to Water: Distilled or Demineralized; Sea, and Chlorinated Pool. Superseded by Methods 105, 106, 107.
64-1977	D	Scouring, Continuous Scouring of Raw Grease Wool.
65-1984	D	Snag Resistance of Women's Nylon Hosiery.
67-1957	D	Wrinkle Recovery of Fabrics: Roller Pressure Crease-Recovery Method.
68-1969	D	Colorfastness to Washing at 105F: Rapid Control Test.
69-1958	D	Damage Caused by Retained Chlorine. Superseded by Method 92.
71-1956	D	Colorfastness to Perspiration: Rapid Control Test.
72-1969	D	Colorfastness to Washing and Shrinkage: Combined Rapid Control Test.
73-1953	D	Shrinkage of Wool Hose: Accelerated Test. Superseded by Method 99.
74-1953	D	Relaxation and Felting Shrinkage of Wool Knit Fabrics (Except Hose): Accelerated Test. Superseded by Method 99.
75-1971	D	Colorfastness to Oxides of Nitrogen in the Atmosphere: Rapid Control Test.
77-1977	D	Scourability of Spinning Lubricant.
78-1989	D	Ash Content of Bleached Cellulosic Textiles.
80-1954	D	Determining the Noncotton Content of Bleached Woven Cotton Cloth. Superseded by Method 97.
83-1974	D	Colorfastness to Light and Washing: Alternate Exposure.
85-1968	D	Colorfastness to Drycleaning. Superseded by Method 132.
87-1965	D	Colorfastness to Washing, Industrial Laundering: Accelerated.
88-1961	D	Appearance of Wash and Wear Fabrics after Home Laundering. Superseded by Method 88A.
88A-1964	D	Appearance of Fabrics in Wash and Wear Items after Home Laundering. Superseded by Method 124.
90-1982	D	Antibacterial Activity of Fabrics, Detection of: Agar Plate Method.
91-1958	D	Dimensional Changes in Woven Textiles (Excluding Wool). Superseded by Method 96.
95-1959	D	Dimensional Restorability of Woven Textiles after Laundering. Superseded by Method 96.
105-1975	D	Colorfastness to Water: Chlorinated Pool. Superseded by Method 162.
108-1963	D	Dimensional Changes in Drycleaning.
111A-1990	D	Weather Resistance: Sunshine Arc Lamp Exposure with Wetting. Superseded by Method 111.
111B-1990	D	Weather Resistance: Exposure to Natural Light and Weather. Superseded by Method 111.
111C-1990	D	Weather Resistance: Sunshine Arc Lamp Exposure without Wetting. Superseded by Method 111.
111D-1990	D	Weather Resistance: Exposure to Natural Light and Weather through Glass. Superseded by Method 111.
113-1978	D	Formaldehyde Odor in Resin Treated Fabric, Determination of: Steam Method.
126-1991	D	Colorfastness to Water (High Humidity) and Light: Alternate Exposure
145-1985	D	Color Measurement of the Blue Wool Lightfastness Standards: Instrumental.
148-1989	D	Light Blocking Effect of Curtain Materials.
152-1990	D	Soil Redeposition, Resistance to: Terg-O-Tometer Method.
153-1985	D	Color Measurement of Textiles: Instrumental. Superseded by Evaluation Procedure 6.
155-1991	D	Transfer of Disperse Dyes on Polyester.
156-1991	D	Transfer of Basic Dyes on Acrylics.
160-1992	D	Dimensional Restoration of Knitted and Woven Fabrics after Laundering.
166-1998	D	Dispersion Stability of Disperse Dyes at High Temperature.
177-2000	D	Colorfastness to Light at Elevated Temperature and Humidity: Xenon Lamp Apparatus
180-1997	D	Colorfastness to Light at High Temperatures: Daylight Temperature Controlled Apparatus

Procedure	Committee	Evaluation Procedure
3 (1996)	D	AATCC 5-Step Chromatic Transference Scale.

Alphabetical List of Current AATCC Test Methods and Procedures

Title	Method Number	Page	Title	Method Number	Page
AATCC 9-Step Chromatic Transference Scale.	EP8	394	Chelating Agents: Percent Content in Hydrogen Peroxide Bleach Baths; Copper PAN Indicator Method	185-2000	346
Abrasion Resistance of Fabrics: Accelerator Method	93-2005	127	Chlorine, Retained, Tensile Loss: Multiple Sample Method	114-2005	181
Absorbency of Bleached Textiles.....	79-2000	103	Chlorine, Retained, Tensile Loss: Single Sample Method.....	92-2004	124
Acid Cellulase Enzymes, Effect of: Top Loading Washer	191-2004	365	Chromatic Transference Scale: AATCC 9-Step Chromatic Transference Scale.....	EP8	394
Ageing of Sulfur-Dyed Textiles: Accelerated.	26-2004	76	Cleaning: Washing of Textile Floor Coverings	138-2005	240
Alkali in Bleach Baths Containing Hydrogen Peroxide	98-2002	143	Color Change Due to Flat Abrasion (Frosting): Emery Method.....	120-2004	197
Alkali in Wet Processed Textiles: Total.....	144-2002	258	Screen Wire Method	119-2004	194
Analysis of Textiles: Finishes, Identification of.....	94-2002	130	Colorfastness to: Acids and Alkalis.....	6-2001	16
Antibacterial Activity Assessment of Textile Materials: Parallel Streak Method ..	147-2004	263	Bleaching with Hydrogen Peroxide.....	101-2004	152
Antibacterial Finishes on Textile Materials: Assessment of	100-2004	149	Burnt Gas Fumes.....	23-2005	68
Antifungal Activity, Assessment on Textile Materials: Mildew and Rot Resistance of Textile Materials	30-2004	81	Crocking: AATCC Crockmeter Method....	8-2005	17
Antimicrobial Activity Assessment of Carpets	174-1998	316	Crocking: Rotary Vertical Crockmeter Method	116-2005	187
Appearance of Apparel and Other Textile End Products after Repeated Home Laundering	143-2001	252	Crocking: Textile Floor Coverings— AATCC Crockmeter Method.....	165-1999	291
Appearance of Fabrics after Repeated Home Laundering	124-2005	205	Drycleaning	132-2004	222
Appearance of Flocked Fabrics after Repeated Home Laundering and/or Coin-Op Drycleaning.....	142-2005	249	Dye Transfer in Storage; Fabric-to-Fabric ..	163-2002	287
Aqueous Liquid Repellency: Water/Alcohol Solution Resistance Test.....	193-2005	376	Heat: Dry (Excluding Pressing).....	117-2004	189
Bacterial Alpha-Amylase Enzymes used in Desizing, Assay of.....	103-2004	157	Heat: Hot Pressing	133-2004	225
Barré: Visual Assessment and Grading.....	178-2004	324	Home Laundering with Activated Oxygen Bleach Detergent: Accelerated	190-2003	362
Bond Strength of Bonded and Laminated Fabrics.....	136-2003	235	Laundering, Home and Commercial: Accelerated.....	61-2003	90
CMC: Calculation of Small Color Differences for Acceptability.....	173-2005	311	Light	16-2004	23
Carpets: Cleaning of; Hot Water Extraction Method	171-2005	306	Light: Detection of Photochromism	139-2005	242
Carpets: Stain Resistance: Pile Floor Coverings	175-2003	319	Light at High Temperatures: Daylight Temperature and Humidity Controlled Apparatus	181-2005	331
Carpet Soiling: Accelerated Soiling Method	123-2000	203	Non-Chlorine Bleach in Home Laundering..	172-2003	308
Service Soiling Method	122-2000	201	Oxides of Nitrogen in the Atmosphere under High Humidities.....	164-2001	289
Visual Rating Method.....	121-2005	199	Ozone in the Atmosphere under Low Humidities	109-2005	165
Chelating Agents: Active Ingredient Content of Polyaminopolycarboxylic Acids and Their Salts; Copper PAN Method.....	168-2002	296	Ozone in the Atmosphere under High Humidities.....	129-2005	215
Chelating Agents: Chelation Value of Aminopolycarboxylic Acids and Their Salts; Calcium Oxalate Method.....	149-2002	265	Perspiration	15-2002	20
Chelating Agents: Disperse Dye Shade Change Caused by Metals; Control of.....	161-2002	282	Perspiration and Light.....	125-2004	209
			Pleating: Steam Pleating	131-2005	220
			Sodium Hypochlorite Bleach in Home Laundering	188-2003	356
			Solvent Spotting: Perchloroethylene	157-2005	275
			Water	107-2002	163
			Water: Chlorinated Pool.....	162-2002	285
			Water: Sea	106-2002	161
			Water Spotting.....	104-2004	160
			Compatibility of Basic Dyes for Acrylic Fibers.....	141-2004	247

Title	Method Number	Page	Title	Method Number	Page
Creases; in Fabrics, Retention of, after Repeated Home Laundering	88C-2003	118	Mildew and Rot Resistance of Textiles: Fungicides	30-2004	81
Dimensional Changes of Fabrics after Home Laundering	135-2004	231	Multifiber Adjacent Fabrics	EP10	399
Dimensional Changes of Garments after Home Laundering	150-2003	267	Oil Repellency: Hydrocarbon Resistance Test	118-2002	191
Dimensional Changes in Commercial Laundering of Woven and Knitted Fabrics Except Wool	96-2004	137	pH of the Water-Extract from Wet Processed Textiles	81-2001	105
Dimensional Changes on Drycleaning in Perchloroethylene: Machine Method	158-2005	277	Photochromism, Detection of	139-2005	242
Dimensional Changes of Fabrics: Accelerated	187-2004	353	Relative Color Strength of Dyes in Solutions	182-2005	335
Dimensional Changes of Woven or Knitted Textiles: Relaxation, Consolidation and Felting	99-2004	145	Retention of Creases in Fabrics after Repeated Home Laundering	88C-2003	118
Dispersibility of Disperse Dyes: Filter Test	146-2001	260	Rug Back Staining on Vinyl Tile	137-2002	238
Drycleaning: Durability of Applied Designs and Finishes	86-2005	112	Seams; in Fabrics; Smoothness of, after Repeated Home Laundering	88B-2003	114
Dusting Behavior of Dyes: Determination of	184-2005	342	Skewness Change in Fabric and Garment Twist Resulting from Automatic Home Laundering	179-2004	327
Dusting Propensity of Powder Dyes: Evaluation of	170-2001	304	Soil Redeposition: Launder-Ometer Method	151-2003	271
Dye and Pigment Migration in a Pad-Dry Process: Evaluation of	140-2001	244	Soil Release: Oily Stain Release Method	130-2000	217
Electrical Surface Resistivity of Fabrics	76-2005	101	Speckiness of Colorant Dispersions: Evaluation of	176-2001	322
Electrical Resistance of Yarns	84-2005	110	Stain Resistance: Pile Floor Coverings	175-2003	319
Electrostatic Clinging of Fabrics: Fabric-to-Metal Test	115-2005	183	Standard Depth Scales for Depth Determination	EP4	383
Electrostatic Propensity of Carpets	134-2001	227	Thermal Fixation Properties of Disperse Dyes	154-2001	273
Extractable Content of Greige and/or Prepared Textiles	97-1999	141	Transfer of Acid and Premetallized Acid Dyes on Nylon	159-1999	280
Fabric Hand: Guidelines for the Subjective Evaluation of	EP5	384	Transmittance or Blocking of Erythemally Weighted Ultraviolet Radiation through Fabrics	183-2004	338
Fabrics; Appearance of, after Repeated Home Laundering	124-2005	205	Visual Assessment of Color Difference of Textiles	EP9	396
Fiber Analysis: Qualitative	20-2005	38	Water Repellency: Spray Test	22-2005	65
Fiber Analysis: Quantitative	20A-2005	57	Water Repellency: Tumble Jar Dynamic Absorption Test	70-2005	99
Finishes in Textiles: Identification	94-2002	130	Water Resistance: Hydrostatic Pressure Test	127-2003	211
Fluidity of Dispersions of Cellulose from Bleached Cotton Cloth	82-2001	106	Water Resistance: Impact Penetration Test ...	42-2000	87
Fluorine Content of Carpet Fibers	189-2002	359	Water Resistance: Rain Test	35-2000	85
Foaming Propensity of Disperse Dyes	167-2003	294	Weather Resistance of Textiles: Exposure to Daylight and Weather	111-2003	169
Formaldehyde Release from Fabric, Determination of: Sealed Jar Method	112-2003	178	Weather Resistance of Textiles: Xenon Lamp Exposure	169-2003	298
Frosting: (Color Change due to Flat Abrasion) Emery Method	120-2004	197	Weather Resistance of Textiles: Sunshine-Arc Lamp Exposure with and without Wetting	192-2005	367
Screen Wire Method	119-2004	194	Weather Resistance: UV Light and Moisture Exposure	186-2001	348
Gray Scale for Color Change	EP1	379	Wetting Agents, Evaluation of	17-2005	35
Gray Scale for Staining	EP2	381	Wetting Agents: Evaluation of Rewetting Agents	27-2004	78
Hydrogen Peroxide by Potassium Titration: Determination of	102-2002	155	Wetting Agents for Mercerization	43-2004	89
Insect Pest Deterrents on Textiles	28-2004	79	Whiteness of Textiles	110-2005	167
Insects, Resistance of Textiles to	24-2004	71	Wrinkle Recovery of Fabrics: Appearance Method	128-2004	213
Instrumental Assessment of the Change in Color of a Test Specimen	EP7	392	Wrinkle Recovery of Woven Fabrics: Recovery Angle	66-2003	95
Instrumental Color Measurement	EP6	386			
Mercerization in Cotton	89-2003	122			
Migration: Dye and Pigment in a Pad-Dry Process: Evaluation of	140-2001	244			

Topical Listing of Current AATCC Test Methods and Procedures

Title	Page	Title	Page
BIOLOGICAL PROPERTIES			
Antibacterial Activity of Fabrics, Assessment of Textile Materials: Parallel Streak Method; Test Method 147-2004.....	263	Colorfastness to Light: Detection of Photochromism; Test Method 139-2005	242
Antibacterial Finishes on Textile Materials, Assessment of; Test Method 100-2004	149	Colorfastness to Non-Chlorine Bleach in Home Laundering; Test Method 172-2003	308
Antifungal Activity, Assessment on Textile Materials: Mildew and Rot Resistance of Textiles; Test Method 30-2004.....	81	Colorfastness to Oxides of Nitrogen in the Atmosphere under High Humidities; Test Method 164-2001	289
Antimicrobial Activity Assessment of Carpets; Test Method 174-1998.....	316	Colorfastness to Ozone in the Atmosphere under High Humidities; Test Method 129-2005	215
Bacterial Alpha-Amylase Enzymes used in Desizing, Assay of; Test Method 103-2004.....	157	Colorfastness to Ozone in the Atmosphere under Low Humidities; Test Method 109-2005.....	165
Insect Pest Deterrents on Textiles; Test Method 28-2004	79	Colorfastness to Perspiration; Test Method 15-2002	20
Insects, Resistance of Textiles to; Test Method 24-2004	71	Colorfastness to Perspiration and Light; Test Method 125-2004	209
		Colorfastness to Pleating: Steam Pleating; Test Method 131-2005	220
		Colorfastness to Sodium Hypochlorite Bleach in Home Laundering; Test Method 188-2003	356
		Colorfastness to Solvent Spotting: Perchloroethylene; Test Method 157-2005.....	275
		Colorfastness to Water; Test Method 107-2002	163
		Colorfastness to Water: Chlorinated Pool; Test Method 162-2002	285
		Colorfastness to Water: Sea; Test Method 106-2002	161
		Colorfastness to Water Spotting; Test Method 104-2004..	160
COLORFASTNESS			
CMC: Calculation of Small Color Differences for Acceptability; Test Method 173-2005	311		
Color Change Due to Flat Abrasion (Frosting): Emery Method; Test Method 120-2004.....	197		
Color Change Due to Flat Abrasion (Frosting): Screen Wire Method; Test Method 119-2004.....	194		
Colorfastness to Acids and Alkalis; Test Method 6-2001	16		
Colorfastness to Bleaching with Hydrogen Peroxide; Test Method 101-2004	152		
Colorfastness to Burnt Gas Fumes; Test Method 23-2005	68		
Colorfastness to Crocking: AATCC Crockmeter Method; Test Method 8-2005	17		
Colorfastness to Crocking: Rotary Vertical Crockmeter Method; Test Method 116-2005	187		
Colorfastness to Crocking: Textile Floor Coverings—AATCC Crockmeter Method; Test Method 165-1999	291		
Colorfastness to Drycleaning; Test Method 132-2004	222		
Colorfastness: Dye Transfer in Storage; Fabric-to-Fabric; Test Method 163-2002.....	287		
Colorfastness to Heat: Dry (Excluding Pressing); Test Method 117-2004	189		
Colorfastness to Heat: Hot Pressing; Test Method 133-2004.....	225		
Colorfastness to Home Laundering with Activated Oxygen Bleach Detergent: Accelerated; Test Method 190-2003	362		
Colorfastness to Laundering, Home and Commercial: Accelerated; Test Method 61-2003.....	90		
Colorfastness to Light; Test Method 16-2004.....	23		
Colorfastness to Light at High Temperatures: Daylight Temperature and Humidity Controlled Apparatus; Test Method 181-2005	331		
		DYEING PROPERTIES	
		Chelating Agents: Disperse Dye Shade Change Caused by Metals; Control of; Test Method 161-2002	282
		Compatibility of Basic Dyes for Acrylic Fibers; Test Method 141-2004	247
		Dispersibility of Disperse Dyes: Filter Test; Test Method 146-2001	260
		Dusting Behavior of Dyes: Determination of; Test Method 184-2005	342
		Dusting Propensity of Powder Dyes: Evaluation of; Test Method 170-2001	304
		Dye and Pigment Migration in a Pad-Dry Process: Evaluation of; Test Method 140-2001	244
		Foaming Propensity of Disperse Dyes; Test Method 167-2003	294
		Relative Color Strength of Dyes in Solutions; Test Method 182-2005	335
		Speckiness of Colorant Dispersions: Evaluation of; Test Method 176-2001	322
		Thermal Fixation Properties of Disperse Dyes; Test Method 154-2001	273
		Transfer of Acid and Premetallized Acid Dyes on Nylon; Test Method 159-1999	280

Title	Page	Title	Page
EVALUATION PROCEDURES			
Chromatic Transference Scale, 9-Step; Evaluation Procedure 8	394	Acid Cellulase Enzymes, Effect of: Top Loading Washer; Test Method 191-2004	365
Evaluation of Multifiber Adjacent Fabrics; Evaluation Procedure 10	399	Ageing of Sulfur-Dyed Textiles: Accelerated; Test Method 26-2004	76
Fabric Hand: Guidelines for the Subjective Evaluation of; Evaluation Procedure 5	384	Appearance of Apparel and Other Textile End Products after Repeated Home Laundering; Test Method 143-2001	252
Gray Scale for Color Change; Evaluation Procedure 1	379	Appearance of Fabrics after Repeated Home Laundering; Test Method 124-2005	203
Gray Scale for Staining; Evaluation Procedure 2	381	Appearance of Flocked Fabric after Repeated Home Laundering and/or Coin-Op Drycleaning; Test Method 142-2005	249
Instrumental Assessment of the Change in Color of a Test Specimen; Evaluation Procedure 7	392	Appearance: Retention of Creases in Fabric after Repeated Home Laundering; Test Method 88C-2003	118
Instrumental Color Measurement; Evaluation Procedure 6	386	Appearance of Seams in Durable Press Items after Repeated Home Laundering; Test Method 88B-2003	114
Standard Depth Scales for Depth Determination; Evaluation Procedure 4	383	Aqueous Liquid Repellency: Water/Alcohol Solution Resistance Test; Test Method 193-2005	376
Visual Assessment of Color Difference of Textiles; Evaluation Procedure 9	396	Barré: Visual Assessment and Grading; Test Method 178-2004	324
IDENTIFICATION AND ANALYSIS			
Alkali in Bleach Baths Containing Hydrogen Peroxide; Test Method 98-2002	143	Bond Strength of Bonded and Laminated Fabrics; Test Method 136-2003	235
Alkali in Wet Processed Textiles: Total; Test Method 144-2002	258	Carpets: Cleaning of; Hot Water Extraction Method; Test Method 171-2005	306
Chelating Agents: Active Ingredient Content of Polyaminopolycarboxylic Acids and Their Salts; Copper PAN Method; Test Method 168-2002	296	Carpets: Electrostatic Propensity of; Test Method 134-2001	227
Chelating Agents: Chelation Value of Aminopolycarboxylic Acids and Their Salts; Calcium Oxalate Method; Test Method 149-2002	265	Carpet Soiling: Accelerated Soiling Method; Test Method 123-2000	203
Chelating Agents: Percent Content in Hydrogen Peroxide Bleach Baths; Copper PAN Indicator Method; Test Method 185-2000	346	Carpet Soiling: Service Soiling Method; Test Method 122-2000	201
CMC: Calculation of Small Color Differences for Acceptability; Test Method 173-2005	311	Carpet Soiling: Visual Rating Method; Test Method 121-2005	199
Extractable Content of Greige and/or Prepared Textiles; Test Method 97-1999	141	Chlorine, Retained, Tensile Loss: Multiple Sample Method; Test Method 114-2005	181
Fiber Analysis: Qualitative; Test Method 20-2005	38	Chlorine, Retained, Tensile Loss: Single Sample Method; Test Method 92-2004	124
Fiber Analysis: Quantitative; Test Method 20A-2005	57	Cleaning: Washing of Textile Floor Coverings; Test Method 138-2005	240
Finishes in Textiles: Identification; Test Method 94-2002	130	Dimensional Changes of Fabrics after Home Laundering; Test Method 135-2004	231
Fluidity of Dispersions of Cellulose from Bleached Cotton Cloth; Test Method 82-2001	106	Dimensional Changes of Garments after Home Laundering; Test Method 150-2003	267
Formaldehyde Release from Fabric, Determination of: Sealed Jar Method; Test Method 112-2003	178	Dimensional Changes in Commercial Laundering of Woven and Knitted Fabrics Except Wool; Test Method 96-2004	137
Hydrogen Peroxide by Potassium Permanganate Titration: Determination of; Test Method 102-2002	155	Dimensional Changes on Drycleaning in Perchloroethylene: Machine Method; Test Method 158-2005	277
Mercerization in Cotton; Test Method 89-2003	122	Dimensional Changes of Fabrics: Accelerated; Test Method 187-2004	353
pH of the Water-Extract from Bleached Textiles; Test Method 81-2001	105	Dimensional Changes of Woven and Knitted Wool Textiles: Relaxation, Consolidation and Felting; Test Method 99-2004	145
Transmittance or Blocking of Erythemally Weighted Ultraviolet Radiation through Fabrics; Test Method 183-2004	338	Drycleaning: Durability of Applied Designs and Finishes; Test Method 86-2005	112
Whiteness of Textiles; Test Method 110-2005	167	Electrical Surface Resistivity of Fabrics; Test Method 76-2005	101
PHYSICAL PROPERTIES			
Abrasion Resistance of Fabrics: Accelerator Method; Test Method 93-2005	127	Electrical Resistance of Yarns; Test Method 84-2005	110
Absorbency of Bleached Textiles; Test Method 79-2000	103	Electrostatic Clinging of Fabrics: Fabric-to-Metal Test; Test Method 115-2005	183
		Electrostatic Propensity of Carpets; Test Method 134-2001	227

Title	Page	Title	Page
Fluorine Content of Carpet Fibers; Test Method 189-2002	359	Water Resistance: Hydrostatic Pressure Test; Test Method 127-2003	211
Oil Repellency: Hydrocarbon Resistance Test; Test Method 118-2002	191	Water Resistance: Impact Penetration Test; Test Method 42-2000	87
Retention of Creases in Fabrics after Repeated Home Laundering; Test Method 88C-2003	118	Water Resistance: Rain Test; Test Method 35-2000	85
Rug Back Staining on Vinyl Tile; Test Method 137-2002	238	Weather Resistance of Textiles: Exposure to Daylight and Weather; Test Method 111-2003	169
Skewness Change in Fabric and Garment Twist Resulting from Automatic Home Laundering; Test Method 179-2004	327	Weather Resistance of Textiles: Sunshine-Arc Lamp Exposure With and Without Wetting; Test Method 192-2005	367
Smoothness of Seams in Fabrics after Repeated Home Laundering; Test Method 88B-2003	114	Weather Resistance of Textiles: Xenon Lamp Exposure; Test Method 169-2003	298
Soil Redeposition: Launder-Ometer Method; Test Method 151-2003	271	Weather Resistance: UV Light and Moisture Exposures; Test Method 186-2001	348
Soil Release: Oily Stain Release Method; Test Method 130-2000	217	Wetting Agents, Evaluation of; Test Method 17-2005	35
Stain Resistance: Pile Floor Coverings; Test Method 175-2003	319	Wetting Agents: Evaluation of Rewetting Agents; Test Method 27-2004	78
Transmittance or Blocking of Erythemally Weighted Ultraviolet Radiation through Fabrics; Test Method 183-2004	338	Wetting Agents for Mercerization; Test Method 43-2004	89
Water Repellency: Spray Test; Test Method 22-2005	65	Wrinkle Recovery of Fabrics: Appearance Method; Test Method 128-2004	213
Water Repellency: Tumble Jar Dynamic Absorption Test; Test Method 70-2005	99	Wrinkle Recovery of Woven Fabrics: Recovery Angle; Test Method 66-2003	95

Changes in AATCC Test Methods

The following changes have been made in AATCC test methods since publication of the 2005 edition of the TECHNICAL MANUAL. The copy deadline for changes in the 2006 edition was May 2005.

8-2005, Colorfastness to Crocking: AATCC Crockmeter Method. Revised to indicate that an automated electronic grading system may be used as an alternate measuring device in place of the prescribed manual measurement devices if it is established that its accuracy is equivalent to the manual devices.

15-2002, Colorfastness to Perspiration. Editorially revised to clarify the test specimen preparation in 8.2.1.

17-2005, Wetting Agents, Evaluation of. Reaffirmed.

20-2005, Fiber Analysis: Qualitative. Revised to change Table I to indicate microscopical appearance (Medulla) for Cashmere to "seldom present" in lieu of "never present."

20A-2005, Fiber Analysis: Quantitative. Revised to add a block in Table II for IWTO Super Fine Wool Grades and add a row at the top of the table showing Fine Wool as being 13.0-19.5 microns in diameter.

22-2005, Water Repellency: Spray Test. Revised to include the use of both types of spray nozzles and spray apparatus. Fig. 1, Spray Test Rating Chart, text has also been changed to correlate with new text.

23-2005, Colorfastness to Burnt Gas Fumes. Revised to indicate that an automated electronic grading system may be used as an alternate measuring device in place of the prescribed manual measurement devices if it is established that its accuracy is equivalent to the manual devices.

70-2005, Water Repellency: Tumble Jar Dynamic Absorption Test. Reaffirmed and editorially revised to update picture of Dynamic Absorption Tester.

76-2005, Electrical Surface Resistivity of Fabrics. Reaffirmed and editorially revised to change source in 11.1.2.

84-2005, Electrical Resistance of Yarns. Reaffirmed.

86-2005, Drycleaning: Durability of Applied Designs and Finishes. Reaffirmed.

88B-2003, Smoothness of Seams in Fabrics after Repeated Home Laundering. Editorially revised to delete reference to Wash Load Ballast Type 2 since it is no longer available and put a tolerance for the ballast specifications.

88C-2003, Retention of Creases in Fabrics after Repeated Home Laundering. Editorially revised to delete reference to Wash Load Ballast Type 2 since it is no longer available and put a tolerance for the ballast specifications.

93-2005, Abrasion Resistance of Fabrics: Accelerator Method. Revised to change liner description throughout method since one of the liners is no longer available.

96-2004, Dimensional Changes in Commercial Laundering of Woven and Knitted Fabrics except Wool. Editorially revised to delete reference to Wash Load Ballast Type 2 since it is no longer available and put a tolerance for the ballast specifications, and to delete reference to AATCC Test Method in Table I since TM 160 has been withdrawn from the TECHNICAL MANUAL.

106-2002, Colorfastness to Water: Sea. Editorially revised to clarify the test specimen preparation in 7.1.

107-2002, Colorfastness to Water. Editorially revised to clarify the test specimen preparation in 7.1.

109-2005, Colorfastness to Ozone in the Atmosphere under Low Humidities. Revised to indicate that an automated electronic grading system may be used as an alternate measuring device in place of the prescribed manual measurement devices if it is established that its accuracy is equivalent to the manual devices.

110-2005, Whiteness of Textiles. Reaffirmed.

114-2005, Chlorine, Retained, Tensile Loss: Multiple Sample Method. Reaffirmed and editorially revised to remove reference to Quadrafos, changing to sodium tetraphosphate.

115-2005, Electrostatic Clinging of Fabrics: Fabric-to-Metal Test. Reaffirmed.

116-2005, Colorfastness to Crocking: Rotary Vertical Crockmeter Method. Revised to include a new technique in wet pickup and to indicate that an automated electronic grading system may be used as an alternate measuring device in place of the prescribed manual measurement devices if it is established that its accuracy is equivalent to the manual devices.

121-2005, Carpet Soiling: Visual Rating Method. Reaffirmed.

124-2005, Appearance of Fabrics after Repeated Home Laundering. Revised to include the new AATCC Standard Liquid Detergent as an alternate to the powder detergent; delete reference to Wash Load Ballast Type 2 since it is no longer available and put a tolerance for the ballast specifications.

125-2004, Colorfastness to Perspiration and Light. Editorially revised to clarify the preparation of reagent in Section 6.

129-2005, Colorfastness to Ozone in the Atmosphere under High Humidities. Revised to indicate that an automated electronic grading system may be used as an alternate measuring device in place of the prescribed manual measurement devices if it is established that its accuracy is equivalent to the manual devices and to correct the dyeing and fading information for the Control Sleeve 129, Lot 10.

130-2000, Soil Release: Oily Stain Release Method. Editorially revised to delete reference to Wash Load Ballast Type 2 since it is no longer available and put a tolerance for the ballast specifications.

131-2005, Colorfastness to Pleating: Steam Pleating. Reaffirmed.

138-2005, Cleaning: Washing of Textile Floor Covering. Reaffirmed.

139-2005, Colorfastness to Light: Detection of Photochromism. Reaffirmed.

142-2005, Appearance of Flocked Fabrics after Repeated Home Laundering and/or Coin-Op Drycleaning. Reaffirmed and editorially revised to delete reference to Wash Load Ballast Type 2 since it is no longer available and put a tolerance for the ballast specifications.

143-2001, Appearance of Apparel and Other Textile End Products after Repeated Home Laundering. Editorially revised to delete reference to Wash Load Ballast Type 2 since it is no longer available and put a tolerance for the ballast specifications.

150-2003, Dimensional Changes of Garments after Home Laundering. Editorially revised to delete reference to Wash Load Ballast Type 2 since it is no longer available and put a tolerance for the ballast specifications.

157-2005, Colorfastness to Solvent Spotting: Perchloroethylene. Reaffirmed.

158-2005, Dimensional Changes on Drycleaning in Perchloroethylene: Machine Method. Reaffirmed.

171-2005, Carpets: Cleaning of; Hot Water Extraction Method. Reaffirmed.

172-2003, Colorfastness to Non-Chlorine Bleach in Home Laundering. Editorially revised to add tolerances to ballast.

173-2005, CMC: Calculation of Small Color Differences for Acceptability. Reaffirmed and editorially revised to update the relationship to ISO 105-J03. A note has been added to advise Committee RA36 intentions toward this relationship.

179-2004, Skewness Change in Fabric and Garment Twist Resulting from Automatic Home Laundering. Editorially revised to delete reference to Wash Load Ballast Type 2 since it is no longer available and put a tolerance for the ballast specifications.

181-2003, Colorfastness to Light at High Temperatures: Daylight Temperature and Humidity Controlled Apparatus. Revised to include the range of 300-400 nm for solar radiation and laboratory light irradiation in 6.3.1, 10.3.1 and 12.1.6.

182-2005, Relative Color Strength of Dyes in Solution. Reaffirmed.

184-2005, Dusting Behavior of Dyes: Determination of. Reaffirmed.

189-2002, Fluorine Content of Carpet Fibers. Editorially revised to change from 1000 mL to 500 mL combustion flask in 5.1.

191-2004, Acid Cellulase Enzymes, Effect of: Top Loading Washer. Editorially revised to add tolerances to ballast.

192-2005, Weather Resistance of Textiles: Sunshine-Arc Lamp Exposure With and Without Wetting. Reaffirmed.

193-2005, Aqueous Liquid Repellency: Water/Alcohol Solution Resistance Test. Reaffirmed and editorially revised to delete reference to 5 lb weight in 6.5 and to correct the number of drops used in the evaluation of the specimens.

AATCC Evaluation Procedure 2, Gray Scale for Staining. Revised to better clarify the use of the Gray Scale for Staining.

AATCC Evaluation Procedure 10, Procedure for the Evaluation of Multifiber Adjacent Fabrics. New AATCC evaluation procedure to permit the qualification of candidate multifiber test fabrics, by comparing the staining of their components with that of a control multifiber fabric, under controlled conditions.

1993 AATCC Standard Reference Detergent and Laundry Detergents in General. Revised to include rationale for use of reference detergents in laboratory testing.

2003 AATCC Standard Reference Liquid Laundry Detergent. Revised to include rationale for use of reference detergents in laboratory testing.

Standardization of Home Laundry Test Conditions. Revised to add note to Table IIA-Washing Machine Setting Conditions without Load, to clarify specifications for models outside of the United States. A change has also been made in Table IV regarding measuring the temperature of dryer exhaust.

Rules of Procedure for AATCC Test Method and Technology Committees. Revised to incorporate changes to the makeup of the Executive Committee on Research, the Technical Committee on Research and the research committees as constituted by the changes made in the AATCC Constitution and Bylaws.

Colorfastness to Acids and Alkalis

Developed in 1925 by AATCC Committee RR1; revised 1945, 1952, 1957; reaffirmed 1972, 1975, 1978, 1989; editorially revised and reaffirmed 1981, 1986, 1994, 2001; editorially revised 1995, 2004. Related to ISO 105-E05 and E06.

1. Purpose and Scope

1.1 Test specimens are evaluated for resistance to simulated action of acid fumes, sizes, alkaline sizes, alkaline cleansing agents and alkaline street dirt. These test methods are applicable to textiles made from all fibers in the form of yarns or fabrics, whether dyed, printed or otherwise colored.

2. Principle

2.1 The specimens are steeped in or spotted with the required solutions by means of simple laboratory equipment. The tested specimens are examined for changes in color.

3. Terminology

3.1 **colorfastness, n.**—the resistance of a material to change in any of its color characteristics, to transfer of its colorant(s) to adjacent materials, or both, as a result of the exposure of the material to any environment that might be encountered during the processing, testing, storage or use of the material.

4. Safety Precautions

NOTE: These safety precautions are for information purposes only. The precautions are ancillary to the testing procedures and are not intended to be all inclusive. It is the user's responsibility to use safe and proper techniques in handling materials in this test method. Manufacturers MUST be consulted for specific details such as material safety data sheets and other manufacturer's recommendations. All OSHA standards and rules must also be consulted and followed.

4.1 Good laboratory practices should be followed. Wear safety glasses in all laboratory areas.

4.2 All chemicals should be handled with care. Use chemical goggles or face

shield, impervious gloves and an impervious apron during dispensing and mixing of hydrochloric acid, acetic acid and ammonium hydroxide.

4.3 An eyewash/safety shower should be located nearby and a self-contained breathing apparatus should be readily available for emergency use.

5. Apparatus, Materials and Reagents

- 5.1 Beaker, 250 mL
- 5.2 Bell jar, 4 L, with a glass plate base
- 5.3 Evaporating dish
- 5.4 Gray Scale for Color Change (see 11.1)
- 5.5 Hydrochloric acid (HCl), 35%
- 5.6 Acetic acid (CH₃COOH), 56%
- 5.7 Ammonium hydroxide (NH₄OH), anhydrous ammonia 28% (NH₃)
- 5.8 Sodium carbonate (Na₂CO₃), anhydrous, technical
- 5.9 Calcium hydroxide [Ca(OH)₂], freshly prepared paste

6. Test Specimens

6.1 These may be cut in any convenient size.

7. Procedure

- 7.1 Acid Tests.
 - 7.1.1 Spot the specimen with the hydrochloric acid solution (100 mL of 35% acid made up to 1 L, add acid to water) at 21°C (70°F), and then dry the specimen at room temperature without rinsing.
 - 7.1.2 Spot the specimen with acetic acid (56%) and dry it at room temperature without rinsing.
- 7.2 Alkali Tests.
 - 7.2.1 Steep the specimen for 2 min at 21°C (70°F) in ammonium hydroxide (28% anhydrous ammonia) and dry it at room temperature without rinsing.
 - 7.2.2 Steep for 2 min at 21°C (70°F) in sodium carbonate (10%) and dry it at room temperature without rinsing.
 - 7.2.3 Suspend the specimen over a 7.6 cm (3 in.) evaporating dish containing 10 mL ammonium hydroxide (28% anhydrous ammonia) for 24 h in a 4 L bell jar placed on a glass plate.
 - 7.2.4 Spot the specimen with calcium hydroxide, a freshly prepared paste, made by mixing the hydroxide with a small

amount of water, and dry the specimen. Then brush the specimen to remove the dry powder.

8. Evaluation

8.1 Rate the effect on the color of the test specimens by reference to the Gray Scale for Color Change (see 11.1).

Grade 5—negligible or no change as shown in Gray Scale Step 5.

Grade 4.5—change in color equivalent to Gray Scale Step 4-5.

Grade 4—change in color equivalent to Gray Scale Step 4.

Grade 3.5—change in color equivalent to Gray Scale Step 3-4.

Grade 3—change in color equivalent to Gray Scale Step 3.

Grade 2.5—change in color equivalent to Gray Scale Step 2-3.

Grade 2—change in color equivalent to Gray Scale Step 2.

Grade 1.5—change in color equivalent to Gray Scale Step 1-2.

Grade 1—change in color equivalent to Gray Scale Step 1.

9. Report

9.1 In reporting results of these tests, state the reagent used as given in the following example:

“This material is in Grade...with respect to colorfastness to hydrochloric acid, etc.”

10. Precision and Bias

10.1 *Precision.* Precision for this test method has not been established. Until a precision statement is generated for this test method, use standard statistical techniques in making any comparisons of test results for either *within-laboratory* or *between-laboratory* averages.

10.2 *Bias.* The colorfastness to acids and alkalis can be defined only in terms of a test method. There is no independent method for determining the true value. As a means of estimating this property, the method has no known bias.

11. Note

11.1 Available from AATCC, P.O. Box 12215, Research Triangle Park NC 27709; tel: 919/549-8141; fax: 919/549-8933; e-mail: orders@aatcc.org.

Colorfastness to Crocking: AATCC Crockmeter Method

Developed in 1936 by AATCC Committee RA38; revised 1937, 1952, 1957, 1961, 1969, 1972, 1985, 1988, 1996, 2004, 2005; reaffirmed 1945; 1989; editorially revised and reaffirmed 1968, 1974, 1977, 1981, 1995, 2001; editorially revised 1986, 2002. Partly equivalent to ISO 105-X12.

1. Purpose and Scope

1.1 This test method is designed to determine the amount of color transferred from the surface of colored textile materials to other surfaces by rubbing. It is applicable to textiles made from all fibers in the form of yarn or fabric whether dyed, printed or otherwise colored. It is not recommended for use for carpets or for prints where the singling out of areas may be too small using this method.

1.2 Test procedures employing white test cloth squares, both dry and wet with water, are given.

1.3 As washing, drycleaning, shrinkage, ironing, finishing, etc., may affect the degree of color transfer from a material, the test may be made before, after, or before and after any such treatment.

2. Principle

2.1 A colored test specimen is rubbed with white crock test cloth under controlled conditions.

2.2 Color transferred to the white test cloth is assessed by a comparison with the Gray Scale for Staining or the Chromatic Transference Scale and a grade is assigned.

3. Terminology

3.1 **colorfastness**, *n.*—the resistance of a material to change in any of its color characteristics, to transfer of its colorant(s) to adjacent materials, or both, as a result of the exposure of the material to any environment that might be encountered during the processing, testing, storage or use of the material.

3.2 **crocking**, *n.*—a transfer of colorant from the surface of a colored yarn or fabric to another surface or to an adjacent area of the same fabric principally by rubbing.

4. Safety Precautions

NOTE: These safety precautions are for information purposes only. The precautions are ancillary to the testing procedure

and are not intended to be all inclusive. It is the user's responsibility to use safe and proper techniques in handling materials in this test method. Manufacturers MUST be consulted for specific details such as material safety data sheets and other manufacturer's recommendations. All OSHA standards and rules must also be consulted and followed.

4.1 Good laboratory practices should be followed. Wear safety glasses in all laboratory areas.

5. Apparatus and Materials

5.1 AATCC Crockmeter (see 13.2, 13.3 and Fig. 1).

5.2 Test Cloth, cut in 50 mm squares (see 13.4).

5.3 AATCC Chromatic Transference Scale (see 13.5).

5.4 Gray Scale for Staining (see 13.5).

5.5 White AATCC Textile Blotting Paper (see 13.5).

5.6 Specimen Holder for Crockmeter (see 13.3).

6. Verification

6.1 Verification checks on the operation of the test and the apparatus should be made routinely and the results kept in a log. The following observations and corrective actions are extremely important to avoid incorrect test results where abnormal crock images can result and influence the rating process.

6.2 Use an in-house poor crocking fabric as a calibration specimen and conduct three dry crock tests.

6.2.1 A poor circular image with uneven dye pick-up may indicate the crocking finger needs resurfacing (see 13.6).

6.2.2 A double, elongated image may indicate a loose clip (see 13.6).

6.2.3 A stretched and streaked crock image may be due to mounting the crock square diagonally.

6.2.4 Scuff marks to the sides of the specimen indicate the loops to the wire clips are positioned downwards and are not high enough to prevent rubbing the specimen surface.

6.2.5 A streak in the center of the crock cloth image and in the direction of rubbing may mean the top of the metal base is warped and not flat. This will require a brace insert to square up the tester base.

6.2.6 If specimen holders are used, place the holder over the specimen on the tester base. Move the crocking finger on the crocking arm to the most forward position and observe whether it hits the inside edge of the holder. If this occurs, move the holder slightly forward for all tests. Without correction, this problem will cause a dark area on one side of the crocking image.

6.2.7 Confirm the wet pick-up techniques (see 9.2).

6.2.8 Replace the abrasive paper on the tester base if it is smooth to the touch in the crocking area compared to the adjacent area, or if slippage of the specimen is noticed (see 13.7).

6.2.9 In routine testing, observe if multiple streaks are on the crocking image. Position specimen normally with the long dimension oblique to the warp and filling. If the direction of rubbing falls along a twill line or surface pattern, etc., then streaks may occur. If they do occur, slightly adjust the angle for testing.

7. Test Specimens

7.1 Two specimens are used, one each for the dry and the wet tests.

7.1.1 Additional specimens may be used to increase the precision of the average (see 12.1).

7.2 Cut specimens at least 50 × 130 mm (2.0 × 5.1 in.) and position for testing preferably with the long dimension oblique to warp and filling or wales and courses.

7.2.1 Larger or full width lab samples may be used without cutting individual specimens, when multiple tests are needed and when using for production testing.

7.3 Yarns. Knit a piece of fabric at least 50 × 130 mm, or wind yarn tightly on a



Fig. 1—Crockmeter.

suitable form at least 50 × 130 mm with the yarn running in the long direction; or otherwise stretched (see 13.8).

8. Conditioning

8.1 Prior to testing, precondition and condition the test specimens and the crock squares for crock testing as directed in ASTM D 1776, Conditioning Textiles for Testing. Condition each specimen for at least 4 h in an atmosphere of 21 ± 1°C (70 ± 2°F) and 65 ± 2% RH by laying each test specimen or crock square separately on a screen or perforated shelf of conditioning rack.

9. Procedures

9.1 Dry Crocking Test.

9.1.1 Place a test specimen on the base of the Crockmeter resting flat on the abrasive cloth with its long dimension in the direction of rubbing (see 13.6 and 13.7).

9.1.2 Place specimen holder over specimen as an added means to prevent slippage.

9.1.3 Mount a white test cloth square, the weave parallel with the direction of rubbing, over the end of the finger which projects downward from the weighted sliding arm. Use the special spiral wire clip to hold the test square in place. Position the clip with loops upward. If the loops point downward they can drag against the test specimen.

9.1.4 Lower the covered finger onto the test specimen. Beginning with the finger positioned at the front end, crank the meter handle 10 complete turns at the rate of one turn per second to slide the covered finger back and forth 20 times. Set and run the motorized tester for 10 complete turns. Refer to individual specifications for any other required number of turns.

9.1.5 Remove the white test cloth square, condition (see 8.1) and evaluate as directed in Section 10. In the case of napped, brushed or sanded material when loose fiber might interfere with the rating, remove the extraneous fibrous material by pressing lightly on the crock circle with the sticky side of cellophane tape before evaluating.

9.2 Wet Crocking Test.

9.2.1 Establish technique (see 13.10) for preparing wet crock cloth squares by weighing a conditioned square, then thoroughly wet out white testing square in distilled water. Prepare only one square at a time.

9.2.2 Weigh dry crock square. Using a syringe tube, graduated pipette or automatic pipetter, draw up water in mL to 0.65 times weight of crocking square. If crocking square weight equals 0.24 gm, the mL used would be 0.24 × 0.65 = 0.16 mL. Lay crocking square on white plastic mesh over a dish. Apply water evenly

over crocking square and weigh the wet square. Calculate wet pickup according to instructions in AATCC Methods 8 and 116, Colorfastness to Crocking test methods. If needed, adjust the amount of water used to wet the square and using a new crocking square, repeat steps. When 65 ± 5% wet pickup is achieved, record the amount of water used. Draw up the recorded amount of water into the syringe tube, graduated pipette or automatic pipetter for each wet crocking performed during the current day. Repeat this process each day.

9.2.3 Avoid evaporative reduction of the moisture content below the specified level before the actual crock test is run.

9.2.4 Continue as directed in 9.1.

9.2.5 Air dry the white test square, then condition (see 8.1) before evaluating. In the case of napped, brushed or sanded material when loose fiber might interfere with the rating, remove the extraneous fibrous material by pressing lightly on the crock circle with the sticky side of cellophane tape before evaluating.

10. Evaluation

10.1 Rate the amount of color transferred from the specimen to the white test square under examination by means of the Chromatic Transference Scale or the Gray Scale for Staining (see 13.11 and 13.14).

10.2 Back the test square with three layers of white test cloth while evaluating.

10.3 Rate dry and wet crocking fastness by means of the Gray Scale for Staining or the 9-step AATCC Chromatic Transference Scale. (Usage of these scales is discussed in AATCC Evaluation Procedures 2, 3 and 8, respectively.)

Grade 5—negligible or no color transfer.

Grade 4.5—color transfer equivalent to Step 4-5 on the Gray Scale for Staining or Row 4.5 on the 9-step AATCC Chromatic Transference Scale.

Grade 4—color transfer equivalent to Step 4 on the Gray Scale for Staining or Row 4 on the 9-step AATCC Chromatic Transference Scale.

Grade 3.5—color transfer equivalent to Step 3-4 on the Gray Scale for Staining or Row 3.5 on the 9-step AATCC Chromatic Transference Scale.

Grade 3—color transfer equivalent to Step 3 on the Gray Scale for Staining or Row 3 on the 9-step AATCC Chromatic

Transference Scale.

Grade 2.5—color transfer equivalent to Step 2-3 on the Gray Scale for Staining or Row 2.5 on the 9-step AATCC Chromatic Transference Scale.

Grade 2—color transfer equivalent to Step 2 on the Gray Scale for Staining or Row 2 on the 9-step AATCC Chromatic Transference Scale.

Grade 1.5—color transfer equivalent to Step 1-2 on the Gray Scale for Staining or Row 1.5 on the 9-step AATCC Chromatic Transference Scale.

Grade 1—color transfer equivalent to Step 1 on the Gray Scale for Staining or Row 1 on the 9-step AATCC Chromatic Transference Scale.

10.4 Average individual results to the nearest 0.1 grade when multiple specimens are tested or when a panel of evaluators rate color transfer.

11. Report

11.1 State whether dry or wet crocking test.

11.2 Report the grade determined in 10.3.

11.3 Report the grade determined in 10.4 to the nearest 0.1 grade.

11.4 State whether Gray Scale for Staining or Chromatic Transference Scale was used for evaluating staining (see 13.5, 13.9).

11.5 If any pretreatment or aftertreatment was given to any specimens (see 1.3) indicate method of treatment.

12. Precision and Bias

12.1 *Precision.* An interlaboratory test was conducted in 1986 to establish the precision of the test method. Testing was conducted under the normal atmospheric conditions of each laboratory and not necessarily under ASTM standard conditions. Two operators at each of 12 laboratories evaluated 5 fabrics in 3 replications by both dry and wet test method. Each of 3 raters independently rated the stained crock squares using both the Gray Scale for Staining and the Chromatic Transference Scale. The original data is on file at the AATCC Technical Center.

12.1.1 The components of variance as standard deviations of the Gray Scale for Staining or Chromatic Transference Scale rating units are given in Table I.

12.1.2 Critical differences are given in Table II.

Table I—Components of Variance

Test Scale	Dry		Wet	
	Chromatic	Gray	Chromatic	Gray
Single Operator/Rater	0.20	0.20	0.24	0.25
Within Laboratory	0.20	0.19	0.31	0.34
Between Laboratory	0.10	0.17	0.38	0.54

Table II—Critical Differences

For the components of variance in Table I, two averages of observed values should be considered significantly different at the 95% probability level if the difference equals or exceeds the following critical differences.

Test Scale	No. of Observations	Dry		Wet	
		Chromatic	Gray	Chromatic	Gray
Single Operator/Rater	1	0.55	0.54	0.68	0.70
	3	0.32	0.31	0.39	0.40
	5	0.24	0.24	0.30	0.31
Within Laboratory	1	0.77	0.75	1.08	1.17
	3	0.60	0.61	0.93	1.02
	5	0.60	0.57	0.90	1.00
Between Laboratory	1	0.82	0.89	1.53	1.90
	3	0.69	0.77	1.43	1.81
	5	0.66	0.74	1.41	1.79

The critical differences were calculated using $t = 1.96$ which is based on infinite degrees of freedom.

Table III—Crock Test Results

	Dry	Wet
Lab A	4.5	3.5
Lab B	4.0	1.5
Difference	0.5	2.0

12.1.3 Example for determining between laboratory differences using one observer and the chromatic scale are given in Table III.

Interpretation: For the dry crock test, since the difference between labs is less than the critical differences in 12.1.2 (0.82), the difference in results is not significant. For the wet crock test, since the difference between labs is greater than the critical difference (1.53), the difference in results is significant.

12.2 *Bias*. The true value of colorfastness to crocking can only be defined in terms of a test method. Within this limitation, this test method has no known bias.

13. Notes

13.1 For carpets, AATCC Method 165, Colorfastness to Crocking: Carpets—AATCC Crockmeter Method, under the jurisdiction of Committee RA57, Floor Covering Test Methods, should be used.

13.2 The AATCC Crockmeter provides a reciprocating rubbing motion simulating the action of a human finger and forearm.

13.3 The AATCC Crockmeter is so designed that the 16 ± 0.3 mm (0.625 ± 0.01 in.) diameter finger moves back and forth, with

each complete turn of the crank, in a straight line along a 104 ± 3 mm track on the specimen, with a downward force of $9 \text{ N} \pm 10\%$ ($2 \text{ lb} \pm 10\%$). Two models, a manual and a motorized Crockmeter are available from SDL Atlas L.L.C., 1813A Associate Lane, Charlotte NC 28217; tel: 704/329-0911; fax: 704/329-0914; e-mail: info@sdlatlas.com.

13.4 Crockmeter Test Cloth is available from Testfabrics Inc., P.O. Box 26, 415 Delaware St., W. Pittston PA 18643; tel: 570/603-0432; fax: 570/603-0433; e-mail: testfabric@aol.com; Textile Innovators Corp., div. of SDL Atlas L.L.C., P.O. Box 8, 101 Forest St., Windsor NC 27983; tel: 252/794-9703; fax: 252/794-9704; e-mail: tic@sdlatlas.com.

13.4.1 Crockmeter Test Cloth should meet the following specifications:

Fiber	100% 10.3-16.8 mm combed cotton staple, desized, bleached, with no optical brightener or finishing material present
Yarn	15 tex (40/1 cotton count), 5.9 turns/cm "z"
Thread count	32 ± 3 warp ends/cm; 33 ± 3 picks filling/cm
Weave	1/1 plain
pH	7 ± 0.5
Mass/sq meter	113 ± 5 g greige; 100 ± 3 g finished
Whiteness	$W = 80 \pm 2$ (Method 110)

13.5 The Chromatic Transference Scale, Gray Scales for Staining and White AATCC Textile Blotting Paper are available from AATCC, P.O. Box 12215, Research Triangle Park NC 27709; tel: 919/549-8141; fax: 919/549-8933; e-mail: orders@aatcc.org.

13.6 Accidental damage to the rubbing finger, spiral clip or abrasive paper should be repaired as follows: neatly renew the abrasive paper; bend the clip further open or shut around a rod slightly smaller in diameter than

the crock peg; resurface the finger by movement on an extra piece of fine emery cloth in a manner simulating regular use.

13.7 The abrasive material currently supplied with the Crockmeter is "Wet or Dry Waterproof Silicon Carbide, W-320-A, Soft Back." Replacement pieces are available from SDL Atlas L.L.C., 1813A Associate Lane, Charlotte NC 28217; tel: 704/329-0911; fax: 704/329-0914; e-mail: info@sdlatlas.com.

13.8 For more convenient crock testing of multiple strands of yarn or thread a dowel attachment is useful. This attachment was developed to avoid the tendency of the standard finger to dig into and push aside the yarns, or slide off them and possibly give erroneous results. This attachment is 25 mm in diameter by 51 mm long. Positioned on its side and held in place by the standard finger, it provides a wider test area, and holds the white test square by two spring loaded clips. For additional information on this development see the article by C. R. Trommer, "Modification of the AATCC Crockmeter for Yarn Testing," *American Dyestuff Reporter*, Vol. 45, No. 12, p357, June 4, 1956; also see articles by S. Korpanty and C. R. Trommer, "An Improved Crockmeter for Yarn Testing," *American Dyestuff Reporter*, Vol. 48, No. 6, p40, March 23, 1959. A yarn testing finger kit for installation on the Crockmeter is available from SDL Atlas L.L.C., 1813A Associate Lane, Charlotte NC 28217; tel: 704/329-0911; fax: 704/329-0914; e-mail: info@sdlatlas.com.

13.9 It has been noted that different grades may result depending upon whether the Gray Scale for Staining or Chromatic Transference Scale is used for the evaluation. It is, therefore, important to report which scale was used.

13.10 Experienced operators do not have to repeat this weighing procedure during a test session once the technique is established.

13.11 For very critical evaluations and in cases of arbitration, grades must be based on the Gray Scale for Staining.

13.12 For a discussion of crock testing, see the article by J. Patton, "Crock Test Problems can be Prevented," *Textile Chemist and Colorist*, Vol. 21, No. 3, p13, March 1989; and "Testing for Crocking: Some Problems and Pitfalls" by Allan E. Gore, *Textile Chemists and Colorists*, Vol. 21, No. 3, p17, March 1989.

13.13 For prints where the singling out of areas too small to test with the standard AATCC Crockmeter is necessary, see AATCC Method 116, Rotary Vertical Crockmeter Method. Specimens tested by both test methods may show dissimilar results. There is no known correlation between the two methods.

13.14 An automated electronic grading system may be used as long as the system has been demonstrated to provide results that are equal to and provide equal or better repeatability and reproducibility than an experienced grader performing visual evaluation.

Colorfastness to Perspiration

Developed in 1949 by AATCC Committee RR52; revised 1952, 1957, 1960, 1962, 1972, 1973, 1975, 1976, 1997; reaffirmed 1967, 1979, 1985, 1989; editorially revised 1961, 1967, 1974, 1981, 1983, 1986, 1995, 2004, 2005; editorially revised and reaffirmed 1994, 2002. Related to ISO 105-E04.

1. Purpose and Scope

1.1 This test method is used to determine the fastness of colored textiles to the effects of acid perspiration. It is applicable to dyed, printed or otherwise colored textile fibers, yarns and fabrics of all kinds and to the testing of dyestuffs as applied to textiles.

1.2 Work by Committee RA52 showed this test will correlate with limited field studies. Prior to this there were acid and alkaline tests; however, as a result of these studies the alkaline test was eliminated (see 13.1).

2. Principle

2.1 A specimen of colored textile in contact with other fiber materials (for color transfer) is wet out in simulated acid perspiration solution, subjected to a fixed mechanical pressure and allowed to dry slowly at a slightly elevated temperature. After conditioning, the specimen is evaluated for color change and the other fiber materials are evaluated for color transfer.

3. Terminology

3.1 **colorfastness**, *n.*—the resistance of a material to change in any of its color characteristics, to transfer of its colorant(s) to adjacent materials or both, as a result of the exposure of the material to any environment that might be encountered during the processing, testing, storage or use of the material.

3.2 **perspiration**, *n.*—a saline fluid secreted by the sweat glands.

4. Safety Precautions

NOTE: These safety precautions are for information purposes only. The precautions are ancillary to the testing procedures and are not intended to be all inclusive. It is the user's responsibility to use safe and proper techniques in handling materials in this test method. Manufacturers MUST be consulted for specific details such as material safety data sheets

and other manufacturer's recommendations. All OSHA standards and rules must also be consulted and followed.

4.1 Follow good laboratory practices. Wear safety glasses in all laboratory areas.

4.2 All chemicals should be handled with care.

4.3 Observe padder safety. Normal safe guards on pad should not be removed. Ensure adequate guard at the nip point. A foot operated kick off is recommended for a motorized padder.

5. Apparatus, Materials and Reagents

5.1 AATCC Perspiration Tester, Spirometer or equivalent device (plastic or glass plates are available with the equipment) (see 13.2 and Figs. 1 and 2).

5.2 Drying oven—convection.

5.3 Balance with a weighing accuracy of ± 0.001 g.

5.4 Multifiber test fabric No. 10 or FA (see 13.3).

5.5 pH meter accurate to ± 0.01 .

5.6 9-step AATCC Chromatic Transference Scale or Gray Scale for Staining (see 13.4).

5.7 Gray Scale for Color Change (see 13.4).

5.8 Wringer (see 13.5).

5.9 White AATCC Blotting Paper (see 13.4).

5.10 Acid perspiration solution.

6. Preparation of Reagent

6.1 Prepare the acid perspiration solution by filling a 1 L volumetric flask half full of distilled water. Add the following chemicals and mix to be sure that all chemicals are thoroughly dissolved:

10 \pm 0.01 g sodium chloride (NaCl)

1 \pm 0.01 g lactic acid, USP 85%

1 \pm 0.01 g sodium phosphate, dibasic, anhydrous (Na₂HPO₄)

0.25 \pm 0.001 g *l*-histidine monohydrochloride (C₆H₉N₃O₂·HCl·H₂O) (see 13.6) Fill the volumetric flask with distilled water to the 1 L mark.

6.2 Test the pH of the solution with a pH meter. If it is not 4.3 ± 0.2 discard it and prepare a new one, making sure all ingredients are weighed accurately. The use of pH test paper is not recommended for this purpose because of its lack of accuracy.

6.3 Do not use perspiration solution that is more than three days old (see 13.7).

7. Verification

7.1 Verification checks on the operation of the test and apparatus should be made routinely and the results kept in a log. The following observations and corrective actions are extremely important to avoid incorrect test results.

7.2 Use an in-house perspiration fabric with a mid-range visual grade on the most heavily stained stripe of the multifiber cloth as a calibration specimen and conduct a perspiration test using three specimens. Verification checks should be performed periodically as well as each time a new lot of multifiber or undyed adjacent fabric is used.

7.2.1 Non-uniform color transfer may be due to improper wet-out procedures or may be a result of uneven pressure on the specimens due to warped plates in the tester. Check the wet-out procedures to be sure that the balance is accurate and that the procedure is being carefully followed. Check all plates to be sure they are in good condition and not warped.

8. Test Specimen

8.1 Number and size of specimens.

8.1.1 Cut one $6 \times 6 \pm 0.2$ cm specimen from each sample and an equal size piece of multifiber test fabric. Do not use multifiber test fabric that has fused edges because it might have thickness variations at the edges which would cause uneven compression during testing. If the fiber or



Fig. 1—AATCC perspiration tester.

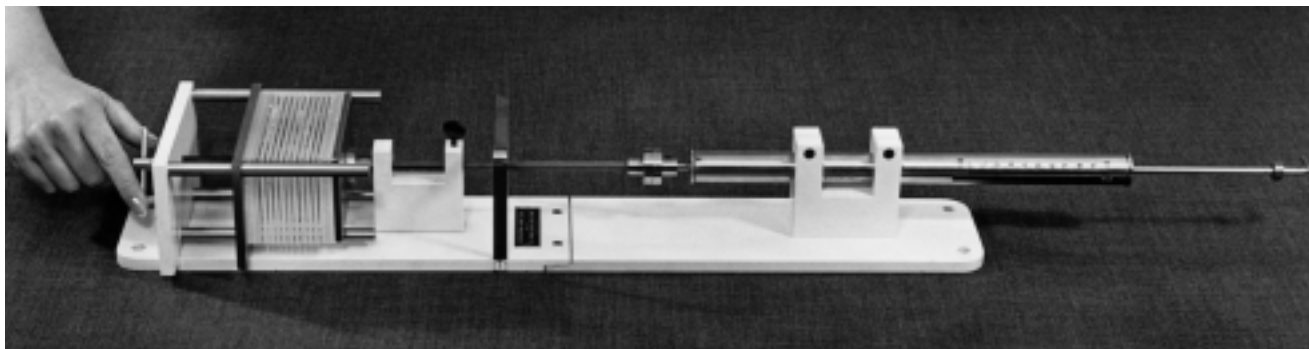

Fig. 2—Perspirometer.

fibers in the dyed fabric are not present in the multifiber test fabric, also include a piece of undyed original material in the test.

8.2 Preparation of specimens.

8.2.1 Sew or lay the multifiber test fabric to the technical face of the test specimen and if used, the undyed original fabric, with the specimen between to make a sandwich assembly.

9. Procedure

9.1 Place each test specimen (as prepared in 8.1 and 8.2) in a 9 cm diameter, 2 cm deep petri dish. Add freshly prepared perspiration solution to a depth of 1.5 cm in the petri dish. Soak the test specimen in the solution for 30 ± 2 min with occasional agitation and squeezing to ensure complete wetting. For fabrics hard to wet out, alternately wet the specimen and pass it through the wringer until it is completely penetrated by the solution.

9.2 After 30 ± 2 min, pass each test specimen assembly through the wringer with the multifiber stripes perpendicular to the length of the wringer rolls (all stripes go through the wringer at the same time). Weigh each test specimen to be sure it weighs 2.25 ± 0.05 times its original weight. Because certain fabrics may not be able to retain this amount of solution when passing through a wringer, such fabrics may be tested after blotting to the required wet pickup with White AATCC Blotting Paper (see 13.4). To obtain consistent results all specimens of a given construction in a test series should have identical pickup, as the degree of staining increases with the amount of retained solution.

9.3 Place each test specimen assembly on a marked plexiglass or glass plate with the multifiber stripes running perpendicular to the long dimension of the plate.

9.4 Depending upon equipment available, use the following alternates:

9.4.1 AATCC Perspiration Tester: Place the plates in the perspiration tester with the specimen assemblies evenly dis-

tributed between the 21 plates. Place all 21 plates into the unit regardless of the number of specimens. After placing the final plate in position (on top) set the dual plates with compensating springs in position, place the 3.63 kg (8.0 lb) weight on top making a total of 4.54 kg (10.0 lb) under the pressure plate, and lock the pressure plate in position by turning the thumb screws. Remove the weight and place the unit lying on its side in the oven.

9.4.2 Perspirometer: Assemble the plates in the perspiration tester with the specimens evenly distributed between the 21 plates. Place all 21 plates into the unit regardless of the number of specimens. The plates are held in a vertical position between an indicating scale with a fixed metal plate at one end and an adjustable metal plate at the other end. Use the adjusting screw to exert a 4.54 kg (10.0 lb) force against the plates. Lock the specimen unit containing the test specimens with a set screw. Remove the pressure gauge unit from the specimen unit and place the specimen unit in the oven. Another specimen unit may be added to the pressure gauge unit and the loading procedure repeated.

9.5 Heat the loaded specimen unit in an oven at $38 \pm 1^\circ\text{C}$ ($100 \pm 2^\circ\text{F}$) for $6 \text{ h} \pm 5 \text{ min}$. Check the oven temperature periodically to be sure it remains at the specified temperature throughout the test.

9.6 Remove the tester from the oven and for each test specimen assembly, separate the multifiber fabric and, if used, the adjacent fabric from the test fabric. Place the multifiber fabric and test fabric specimens separately on a wire screen in a conditioned atmosphere ($21 \pm 1^\circ\text{C}$, $65 \pm 5\%$ RH) overnight.

10. Evaluation

10.1 General—Unsatisfactory perspiration fastness may be due to bleeding or migration of color or it may be due to change in color of the dyed material. It should be noted that objectionable change in color may be encountered with no apparent bleeding. On the other hand,

there may be bleeding with no apparent change in color, or there may be both bleeding and change in color.

10.2 Rate the effect on the color of the test specimens by reference to the Gray Scale for Color Change. (Usage of this scale is discussed in Evaluation Procedure 1.)

Grade 5—negligible or no change as shown in Gray Scale Step 5.

Grade 4.5—change in color equivalent to Gray Scale Step 4-5.

Grade 4—change in color equivalent to Gray Scale Step 4.

Grade 3.5—change in color equivalent to Gray Scale Step 3-4.

Grade 3—change in color equivalent to Gray Scale Step 3.

Grade 2.5—change in color equivalent to Gray Scale Step 2-3.

Grade 2—change in color equivalent to Gray Scale Step 2.

Grade 1.5—change in color equivalent to Gray Scale Step 1-2.

Grade 1—change in color equivalent to Gray Scale Step 1.

10.3 Rate the staining on each fiber type of the multifiber, and the undyed original fabric if used, by means of the Gray Scale for Staining or the 9-step AATCC Chromatic Transference Scale. (Usage of these scales is discussed in AATCC Evaluation Procedures 2 and 8, respectively.)

Grade 5—negligible or no color transfer.

Grade 4.5—color transfer equivalent to Step 4-5 on the Gray Scale for Staining or Row 4.5 on the 9-step AATCC Chromatic Transference Scale.

Grade 4—color transfer equivalent to Step 4 on the Gray Scale for Staining or Row 4 on the 9-step AATCC Chromatic Transference Scale.

Grade 3.5—color transfer equivalent to Step 3-4 on the Gray Scale for Staining or Row 3.5 on the 9-step AATCC Chromatic Transference Scale.

Grade 3—color transfer equivalent to Step 3 on the Gray Scale for Staining or Row 3 on the 9-step AATCC Chromatic Transference Scale.

Grade 2.5—color transfer equivalent to Step 2-3 on the Gray Scale for Staining or Row 2.5 on the 9-step AATCC Chromatic Transference Scale.

Grade 2—color transfer equivalent to Step 2 on the Gray Scale for Staining or Row 2 on the 9-step AATCC Chromatic Transference Scale.

Grade 1.5—color transfer equivalent to Step 1-2 on the Gray Scale for Staining or Row 1.5 on the 9-step AATCC Chromatic Transference Scale.

Grade 1—color transfer equivalent to Step 1 on the Gray Scale for Staining or Row 1 on the 9-step AATCC Chromatic Transference Scale.

11. Report

11.1 Report the color change grade and the staining grades for each fiber type in the multifiber test sample and state which scale (Gray Scale for Staining or 9-step AATCC Chromatic Transference Scale) was used in the staining evaluation (see 13.4).

12. Precision and Bias

12.1 *Precision*. Precision for this test method has not been established. Until a precision statement is generated for this test method, use standard statistical techniques in making any comparisons of test results for either *within-laboratory* or

between-laboratory averages.

12.2 *Bias*. The colorfastness to perspiration can be defined only in terms of a test method. There is no independent method for determining the true value. As a means of estimating this property, the method has no known bias.

13. Notes

13.1 Background information on the committee's work and decision to eliminate the alkaline test was published in two articles in *Textile Chemist and Colorist*: "Colorfastness to Perspiration and Chemicals" (October 1974) and "Evaluating Colorfastness to Perspiration: Laboratory Test vs. Wear Test" (November 1974). Although the alkaline test has been eliminated from this method, there may be certain instances in foreign trade or special end-uses that require the alkaline test. In these instances the alkaline test should be run as in AATCC Method 15-1973. For convenient reference the composition of the alkaline solution is as follows: Alkaline Solution—10 g sodium chloride; 4 g ammonium carbonate, USP; 1 g sodium phosphate, dibasic, anhydrous (Na_2HPO_4); 0.25 g *l*-histidine monohydrochloride. Make up to one liter with distilled water. This solution should give a pH of 8.0.

13.2 The AATCC Perspiration Tester is available from SDL Atlas L.L.C., 1813A Associate Lane, Charlotte NC 28217; tel: 704/329-0911; fax: 704/329-0914; e-mail: info@sdlatlas.com. The Perspirometer is available from The Orange Machine and Mfg. Co., 1503 Bay Ave., Point Pleasant NJ 08742;

tel: 908/295-2262. Purchase an adequate number of plates with either unit for routine testing needs.

13.3 Multifiber test fabric is available from Testfabrics Inc., P.O. Box 26, 415 Delaware St., W. Pittston PA 18643; tel: 570/603-0432; fax: 570/603-0433; e-mail: testfabric@aol.com. Multifiber test fabric is also available from Textile Innovators Corp., div. of SDL Atlas L.L.C., P.O. Box 8, 101 Forest St., Windsor NC 27983; tel: 252/794-9703; fax: 252/794-9704; e-mail: tic@sdlatlas.com. The six fiber test fabric #10 or FA without fused edges should be used in this method.

13.4 The 9-step AATCC Chromatic Transference Scale, Gray Scale for Staining, Gray Scale for Color Change and White AATCC Blotting Paper are available from AATCC, P.O. Box 12215, Research Triangle Park NC 27709; tel: 919/549-8141; fax: 919/549-8933; e-mail: orders@aatcc.org.

13.5 A suitable wringer is the Atlas Motorized Laboratory Wringer available from SDL Atlas L.L.C., 1813A Associate Lane, Charlotte NC 28217; tel: 704/329-0911; fax: 704/329-0914; e-mail: info@sdlatlas.com.

13.6 *l*-Histidine monohydrochloride can be purchased from Fisher Scientific; tel: 800-766-7000.

13.7 Committee RR52 established that fungi begin to grow in the acid perspiration solution and that the pH gradually rises after three days of storage under ambient room temperatures, even when kept in a stoppered solution bottle.

13.8 For very critical evaluations and in the case of arbitration, ratings must be based on the geometric Gray Scale for Staining.

Colorfastness to Light

Developed in 1964 by AATCC Committee RA50; revised 1971, 1974, 1978, 1981, 1982, 1990 (Supersedes AATCC Test Methods 16-1987, 16A-1988, 16C-1988, 16D-1988, 16E-1987, 16F-1988 and 16G-1985), 1993, 2003, 2004; reaffirmed 1977, 1998; editorially revised 1983, 1984, 1986, 1995, 1996. Technically equivalent: Option 6-ISO 105-B01; Related to Option 3-ISO 105-B02.

1. Purpose and Scope

1.1 This test method provides the general principles and procedures which are currently in use for determining the colorfastness to light of textile materials. The test options described are applicable to textile materials of all kinds and for colorants, finishes and treatments applied to textile materials.

Test options included are:

- 1—Enclosed Carbon-Arc Lamp, Continuous Light
- 2—Enclosed Carbon-Arc Lamp, Alternate Light and Dark
- 3—Xenon-Arc Lamp, Continuous Light, Black Panel Option
- 4—Xenon-Arc Lamp, Alternate Light and Dark
- 5—Xenon-Arc Lamp, Continuous Light, Black Standard Option
- 6—Daylight Behind Glass

1.2 The use of these test options does not imply, expressly or otherwise, an accelerated test for a specific application. The relationship between any lightfastness test and the actual exposure in use must be determined and agreed upon by the contractual parties.

1.3 This test method contains the following sections that assist in the use and implementation of the various options for determining lightfastness of textile materials.

	Section
Terminology.....	3
Safety Precautions.....	4
Uses and Limitations.....	5
Apparatus and Materials.....	6
Comparison Standards.....	7
Test Specimen Preparation.....	8
Machine Operating Conditions ...	9
Calibration and Verification.....	10-12
AATCC Fading Unit	
Measurement.....	13-14
Machine Exposure Procedures....	15-18
Daylight Exposure Procedures....	19-22
Evaluation of Results.....	23-27
Report.....	28

Precision and Bias.....	29-30
References.....	31
Notes.....	32
Appendix.....	A-C

2. Principle

2.1 Samples of the textile material to be tested and the agreed upon comparison standard(s) are exposed simultaneously to a light source under specified conditions. The colorfastness to light of the specimen is evaluated by comparison of the color change of the exposed portion to the masked control portion of the test specimen or unexposed original material using the AATCC Gray Scale for Color Change, or by instrumental color measurement. Lightfastness classification is accomplished by evaluation versus a simultaneously exposed series of AATCC Blue Wool Lightfastness Standards.

3. Terminology

3.1 **AATCC Blue Wool Lightfastness Standard**, n.—one of a group of dyed wool fabrics distributed by AATCC for use in determining the amount of light exposure of specimens during lightfastness testing (see 32.1).

3.2 **AATCC Fading Unit (AFU)**, n.—a specific amount of exposure made under the conditions specified in various test methods where one AFU is one-twentieth (1/20) of the light-on exposure required to produce a color change equal to Step 4 on the Gray Scale for Color Change or 1.7 ± 0.3 CIELAB units of color difference on AATCC Blue Wool Lightfastness Standard L4.

3.3 **black-panel thermometer**, n.—a temperature measuring device, the sensing unit of which is coated with black paint designed to absorb most of the radiant energy encountered in lightfastness testing (see 32.2).

3.3.1 This device provides an estimation of the maximum temperature a specimen may attain during exposure to natural or artificial light. Any deviation from the geometry of this device described in 32.2 may have an influence on the measured temperature.

3.4 **black standard thermometer**, n.—a temperature measuring device, the sensing unit of which is coated with black material designed to absorb most of the radiant energy encountered in lightfastness testing and is thermally insulated by means of a plastic plate (see 32.2).

3.4.1 This device provides an estima-

tion of the maximum temperature a specimen may attain during exposure to natural or artificial light. Any deviation from the geometry of the device described in 32.2 may have an influence on the measured temperature. The temperature measured by the black standard thermometer will not be the same as that measured by the black-panel thermometer; therefore, they cannot be used interchangeably.

3.5 **broad bandpass radiometer**, n.—a relative term applied to radiometers that have a bandpass width of more than 20 nm at 50% of maximum transmittance and can be used to measure irradiance at wavelengths such as 300-400 nm or 300-800 nm.

3.6 **color change**, n.—as used in colorfastness testing, a change in color of any kind whether a change in lightness, hue or chroma or any combination of these, discernible by comparing the test specimen with a corresponding untested specimen.

3.7 **colorfastness**, n.—the resistance of a material to change in any of its color characteristics, to transfer of its colorant(s) to adjacent materials, or both as a result of exposure of the material to any environment that might be encountered during the processing, testing, storage or use of the material.

3.8 **colorfastness to light**, n.—the resistance of a material to a change in its color characteristics as a result of exposure of the material to sunlight or an artificial light source.

3.9 **infrared radiation**, n.—radiant energy for which the wavelengths of the monochromatic components are greater than those for visible radiation and less than about 1 mm.

NOTE: The limits of the spectral range of infrared radiation are not well defined and may vary according to the user. Committee E-2.1.2 of the CIE distinguishes in the spectral range between 780 nm and 1 mm:

IR-A	780-1400 nm
IR-B	1.4-3.0 μ m
IR-C	3 μ m to 1 mm

3.10 **irradiance**, n.—radiant power per unit area incident on a receiver, typically reported in watts per square meter, W/(m²nm).

3.11 **“L” designation**, n.—the sequence number given each AATCC Blue Wool Lightfastness Standard according to the number of AATCC Fading Units required to produce a color change equal to Step 4 on the AATCC Gray Scale for Color Change.

NOTE: See Table II for the numerical relationship between "L" designations of the standards and their colorfastness to light in AFUs. The colorfastness to light of a fabric specimen can be determined by comparing its color change after light exposure with that of the most similar AATCC Blue Wool Lightfastness Standard as shown in Table III.

3.12 **langley**, n.—a unit of total solar radiation equivalent to one gram calorie per square centimeter of irradiated surface.

NOTE: The internationally recommended units are: Joule (J) for quantity of radiant energy, watt (W) for quantity of radiant power, and meter squared (m^2) for area. The following factors are to be used: 1 langley = 1 cal/cm²; 1 cal/cm² = 4.184 J/cm² or 41840 J/m².

3.13 **lightfastness**, n.—the property of a material, usually an assigned number, depicting a ranked change in its color characteristics as a result of exposure of the material to sunlight or an artificial light source.

3.14 **narrow bandpass radiometer**, n.—a relative term applied to radiometers that have a bandpass width of 20 nm or less at 50% of maximum transmittance and can be used to measure irradiance at wavelengths such as 340 or 420, \pm 0.5 nm.

3.15 **photochromism**, n.—a qualitative designation for a reversible change in color of any kind (whether a change in hue or chroma) which is immediately noticeable upon termination of light exposures when the exposed area of a specimen is compared to the unexposed area.

NOTE: The reversion of the color change or instability of the hue or chroma upon standing in the dark distinguishes photochromism from fading.

3.16 **pyranometer**, n.—a radiometer used to measure the global solar irradiance or, if inclined, hemispherical solar irradiance.

3.17 **radiant power**, n.—energy per unit time emitted, transferred or received as radiation.

3.18 **radiometer**, n.—an instrument used to measure radiant energy.

3.19 **total irradiance**, n.—radiant power integrated over all wavelengths at a point in time expressed in watts per square meter (W/m^2).

3.20 **ultraviolet radiation**, n.—radiant energy for which the wavelengths of the monochromatic components are smaller than those for visible radiation and more than about 100 nm.

NOTE: The limits of the spectral range of ultraviolet radiation are not well defined and may vary according to the user. Committee E.2.1.2 of the CIE distinguishes in the spectral range between 400 and 100 nm:

UV-A 315-400 nm

UV-B 280-315 nm

UV-C 100-280 nm

3.21 **visible radiation**, n.—any radiant energy capable of causing a visual sensation.

NOTE: The limits of the spectral range of visible radiation are not well defined and may vary according to the user. The lower limit is generally taken between 380 and 400 nm and the upper limit between 760 and 780 nm (1 nanometer, 1 nm = 10^{-9} m).

3.22 **xenon reference fabric**, n.—a dyed polyester fabric used for verifying xenon-arc equipment test chamber temperature conditions during a lightfastness test cycle (see 32.3, 32.4 and 32.6).

3.23 For definitions of other terms relative to lightfastness used in this test method, refer to the *Glossary of AATCC Standard Terminology*.

4. Safety Precautions

NOTE: These safety precautions are for information purposes only. The precautions are ancillary to the testing procedures and are not intended to be all inclusive. It is the user's responsibility to use safe and proper techniques in handling materials in this test method. Manufacturers MUST be consulted on specific details such as material safety data sheets and other manufacturer's recommendations. All OSHA standards and rules must also be consulted and followed.

4.1 Do not operate the test equipment until the manufacturer's instructions have been read and understood. It is the operator's responsibility to conform to the manufacturer's directions for safe operation.

4.2 The test equipment contains high intensity light sources. Do not look directly at the light source. The door to the test chamber must be kept closed when the equipment is in operation.

4.3 Before servicing light sources, allow 30 min for cool-down after lamp operation is terminated.

4.4 When servicing the test equipment, shut off both the off switch and the main power disconnect switch. When equipped, ensure that the main power indicator light on the machine goes out.

4.5 Daylight exposure of the skin and eyes for prolonged periods may be hazardous and therefore caution should be employed to protect these areas. Do not look directly at the sun under any circumstances.

4.6 Good laboratory practices should be followed. Wear safety glasses in all laboratory areas.

5. Uses and Limitation

5.1 Not all materials are affected

equally by the same light source and environment. Results obtained by the use of any one test option may not be representative of those of any other test option or any end-use application unless a mathematical correlation for a given material and/or a given application has been established. Enclosed Carbon-Arc, Xenon-Arc and Daylight have been extensively used in the trade for acceptance testing of textile materials. There may be a distinct difference in spectral power distribution, air temperature and humidity sensor locations, and test chamber size between test equipment supplied by different manufacturers that can result in differences in reported test results. Consequently, data obtained from equipment supplied by the different manufacturers, different test chamber size, or different light source and filter combinations cannot be used interchangeably, unless a mathematical correlation has been established. No correlations among differently constructed test apparatus are known to AATCC Committee RA50.

5.2 Results from Xenon-Arc, for all materials should be in good agreement with the results obtained in Daylight Behind Glass (see Table II). Since the spectral distribution of Xenon-Arc, Alternate Light and Dark, equipped with the specified filter glass is very close to that of average or typical daylight behind window glass, it is expected that results should be in good agreement with the results obtained in Daylight, Daylight Behind Glass. The two carbon-arc options, Continuous and Alternating Light and Dark, under the conditions specified, will produce results which correlate with those obtained in the Daylight Behind Glass Method unless the material being tested is adversely affected by the differences in spectral characteristics of Enclosed Carbon-Arc and natural light.

5.3 When using this test method, the test method option selected should incorporate light, humidity, and heat effects based upon historical data and experience. The test method option selected should also reflect expected end-use conditions associated with the material to be tested.

5.4 When using this test method, use a standard of comparison which has a known change in lightfastness after a specific exposure for comparison to the material to be tested. AATCC Blue Wool Lightfastness Standards have been used extensively for this purpose.

6. Apparatus and Materials

6.1 AATCC Blue Wool Lightfastness Standards L2 through L9 (see 32.1 and 32.5).

6.2 Xenon Reference Fabric (see 32.3, 32.4, 32.5 and 32.6).

Table I—Machine Exposure Conditions by Option

Component	Option 1	Option 2	Option 3	Option 4	Option 5
Light Source	Enclosed Carbon ^a	Enclosed Carbon ^a	Xenon ^{b,c}	Xenon ^b	Xenon ^{b,c,d}
	Continuous Light	Alternate Light/Dark	Continuous Light	Alternate Light/Dark	Continuous Light
Black Panel Temperature, Light Cycle	63 ± 3°C (145 ± 6°F)	63 ± 3°C (145 ± 6°F)	63 ± 1°C (145 ± 2°F)	— —	— —
Black Standard Temperature, Light Cycle	— —	— —	— —	70 ± 1°C (158 ± 2°F)	60 ± 3°C (140 ± 8°F)
Chamber Air Temperature, Light Cycle	43 ± 2°C (110 ± 4°F)	43 ± 2°C (110 ± 4°F)	43 ± 2°C (110 ± 4°F)	43 ± 2°C (110 ± 4°F)	32 ± 5°C (90 ± 9°F)
Dark Cycle	— —	43 ± 2°C (110 ± 4°F)	— —	43 ± 2°C (110 ± 4°F)	— —
Relative Humidity, % Light Cycle	30 ± 5	35 ± 5	30 ± 5	35 ± 5	30 ± 5
Dark Cycle	—	90 ± 5	—	90 ± 5	—
Light Cycle, Hours Light-On	Continuous	3.8	Continuous	3.8	Continuous
Light-Off	—	1.0	—	1.0	—
Filter Type	Borosilicate	Borosilicate	see A.3.3	see A.3.3	see A.3.3
Irradiance W/m ² /nm (at 420 nm)	Not controlled	Not controlled	1.10 ± 0.03	1.10 ± 0.03	1.25 ± 0.2
Irradiance W/m ² (300-400 nm)	Not controlled	Not controlled	48 ± 1	48 ± 1	65 ± 1
Water Requirements (Input) Type		demineralized, distilled or reverse osmosis			
Solids—ppm		less than 17 ppm, preferably less than 8			
pH		7 ± 1			
Temperature		Ambient 16 ± 5°C (61 ± 9°F)			

^a See Appendix C.

^b See Appendix A.

Be sure that the temperature chosen is appropriate for the type of Black Thermometer to be used.

^c Options 3 and 5 have different temperature set-points specified because of the differences in the thermal sensing elements between the Black Panel Thermometer and the Black Standard Thermometer.

^d Option 5 should be used at the recommendation of the equipment manufacturer.

6.3 L4 AATCC Blue Wool Standard of Fade for 20 AATCC Fading Units (AFU) (see 32.5).

6.4 L2 AATCC Blue Wool (alternate) Standard of Fade for 20 AATCC Fading Units (AFU) (see 11.2, 32.5).

6.5 Xenon Reference Fabric Standard of Fade (see 32.5).

6.6 AATCC Gray Scale for Color Change (see 32.5).

6.7 Card stock: 163 g/m² (90 lb) one ply, White Bristol Index (see 32.7).

6.8 Test masks made of material approaching zero light transmittance, and suitable for multiple exposure levels, such as 10, 20, 40, etc. AFU (see 32.8).

6.9 Black-Panel Thermometer (see 3.3, 32.2 and 32.9).

6.10 Black Standard Thermometer (see 3.4, 32.2 and 32.9).

NOTE: The Black-Panel Thermometer should not be confused with the Black Standard Thermometer which is used in Xenon-Arc, Continuous Light, Option 5,

and some European test procedures. Temperatures as measured by the two different devices generally will not agree at the same test condition. The term *Black Thermometer*, as used in this method, refers to both the Black Panel and Black Standard Thermometers.

6.11 Spectrophotometer or Colorimeter (see 31.2).

6.12 Xenon-Arc Lamp Fading Apparatus optionally equipped with light monitors and control systems (see 32.9 and Appendix A).

6.13 Daylight Exposure Cabinet (see 32.10 and Appendix B).

6.14 Enclosed Carbon-Arc Lamp Fading Apparatus (see 32.9 and Appendix C).

7. Comparison Standards

7.1 AATCC Blue Wool Lightfastness Standards, as defined in Method 16, are preferred for all options. However, the rate of fade of any AATCC Blue Wool Light-

fastness Standard by one test option may not agree with that of other test options.

7.2 The reference standard can be any suitable textile material where a history of the rate of color change is known. Reference standards for comparison must be determined and agreed upon by the contractual parties. Standards must be exposed simultaneously with the test specimen. The use of the standard assists in determining time-to-time equipment and test procedure variations. If test results of the exposed standards differ by more than 10% from the known standard data, thoroughly review the test equipment operating conditions, and correct any malfunctions or defective parts. Then, repeat the test.

8. Test Specimen Preparation

8.1 Number of Specimens—For acceptance testing, use at least three replicate specimens of both the material to be

tested and the standard for comparison to ensure accuracy unless otherwise agreed upon between the purchaser and the supplier.

NOTE: It is recognized that in practice one test and one control specimen are used for test purposes. While such a procedure cannot be accepted in cases of dispute, it may be sufficient in routine testing.

8.2 Specimen Cutting and Mounting—Identify each sample using a label resistant to the environment encountered during the test. Mount in frames such that the surface of the test specimen and the reference specimen are the same distance from the light source. Use covers that avoid specimen surface compression, particularly when testing pile fabrics. The test specimen and the reference standards shall be of equal size and shape. Cut and prepare test specimens for exposure as follows:

8.2.1 Specimen Backing—For all options, mount the specimens and standards on white card stock. When mounted test specimens are masked, use test masks approaching zero light transmittance. For Option 6, put the mounted, or mounted and masked, test specimens in frames with backing as directed in an applicable specification: such as open-backed, solid metal, or solid backing (see 32.4, 32.7 and 32.8).

8.2.2 Fabric—Cut swatches of fabric with the long direction parallel to the machine (warp) direction, at least 70.0 × 120.0 mm (2.75 × 4.7 in.) with the exposed area measuring not less than 30.0 × 30.0 mm (1.2 × 1.2 in.). Secure the backed specimens in the frames supplied with the test apparatus. Ensure that front and back covers of the holders make good contact with the specimens and give a sharp line of demarcation between the exposed and unexposed areas without compressing the specimen unnecessarily (see 32.11 and 32.12). When required to prevent raveling, the samples may be edged by sewing, pinking or fusing.

8.2.3 Yarns—Wind or fasten yarns on frames of white card stock to a length of approximately 150.0 mm (6.0 in.). Only that portion of the yarns directly facing the radiant energy is evaluated for color change. Wind the yarn on the frame closely packed to at least 25.0 mm (1.0 in.) width. The control sample must contain the same number of strands as the sample subjected to exposure. After the exposure has been completed, bind together those yarns facing the light source using 20.0 mm (0.75 in.) masking or other suitable tape to keep the yarns closely packed on the exposure frame for evaluation (see 32.12).

Machine Operating Conditions

9. Preparation of Test Apparatus

9.1 Prior to running the test procedure, verify machine operation by using the following test protocol. To enhance the repeatability of test results, install test apparatus in a room where temperature and relative humidity are controlled in accordance with the manufacturer's recommendations.

9.2 Check to see that the machine has been calibrated and maintained within the manufacturer's recommended calibration schedule interval.

9.3 Turn off all rack and specimen spray units, if applicable.

9.4 Set machine operating conditions according to Table I and the specified option. Be sure that the temperature chosen is appropriate for the type of Black Thermometer to be used (see 32.2). Fill the specimen rack with framed white card stock and the required black thermometer unit. The white card stock is used to simulate air flow in the test chamber during the test exposure and should not include the actual test specimens. Support the black thermometer unit in the specimen drum or rack in the same manner as the test specimen frames. Operate and control the test apparatus as specified in Table I and further defined by the manufacturer. Operate the test apparatus in this mode and adjust the instrumentation to provide the required black panel or black standard temperature, chamber air temperature and relative humidity. When exterior indicators are not available, read the black thermometer unit through the window in the test chamber door.

9.5 Calibrate using AATCC Blue Wool Lightfastness Standards following the guidelines in 11.1-11.2.2. If the fade of the L2 or L4 standards do not meet these requirements follow the instrument manufacturer's instructions for calibration and repeat the 20 AFU exposure with fresh L2 or L4 standards. If the fade does meet the requirements described in Section 11 remove the white card stock from the specimen rack and proceed.

9.6 For additional information to prepare and operate the test apparatus refer to the manufacturer's instructions and the following:

9.6.1 For Both Enclosed Carbon-Arc Options, use Test Standard ASTM G 151 and G 153 (see 31.3 and 31.4).

9.6.2 For Daylight Behind Glass, use Test Standard ASTM G 24 (see 31.5).

9.6.3 For all Xenon Options, use Test Standard ASTM G 151 and G 155 (see 31.3 and 31.6).

9.6.4 For Options as applicable, refer to ISO 105, Part B (see 31.7).

10. Calibration, Verification and AATCC Fading Unit Measurement

10.1 Instrument Calibration—To ensure standardization and accuracy, the instruments associated with the exposure apparatus (that is, light monitor control system, Black Thermometers, chamber air sensor, humidity control system, UV sensors and radiometers) require periodic calibration. Whenever possible, calibration should be traceable to national or international standards. Calibration schedule and procedure should be in accordance with manufacturer's instructions.

10.1.1 The accuracy of machine operation must be verified by exposure of an applicable AATCC Blue Wool Lightfastness Standard and assessment of the Standard after every 80-100 AATCC Fading Units. Always expose reference standards near the center position of the specimen rack adjacent to the black-panel temperature sensing unit.

11. Calibration by AATCC Blue Wool Lightfastness Standards

11.1 Carbon-Arc Options 1 and 2; Xenon-Arc Options 3 and 4, expose the L4 AATCC Blue Wool Lightfastness Standard at the specified temperature, humidity and selected option for 20 ± 2 continuous light-on operating hours (see Table II for the corresponding AATCC Fading Units for xenon lamp options). After exposure, assess the exposed standard specimen, either visually or instrumentally. Increase or decrease the wattage of the lamps, the time of exposure, of both, and expose additional standard specimens until the change in color of the exposed standard meets one of the following criteria.

Table II—AATCC Fading Unit and Light Exposure Equivalents for AATCC Blue Wool Lightfastness Standards (see 32.18)^a

AATCC Blue Wool Lightfastness Standard	AATCC Fading Units	Xenon Only kJ/(m ² nm) @ 420 nm	Xenon Only kJ/(m ² nm) 300-400 nm
L2	5	21	864
L3	10	43	1728
L4	20	85 ^b	3456
L5	40	170	6912
L6	80	340 ^b	13824
L7	160	680	27648
L8	320	1360	55296
L9	640	2720	110592

^a For color change of 1.7 ± 0.3 CIELAB units or Step 4 on the AATCC Gray Scale for Color Change.

^b Verified by experiment using Daylight Behind Glass and Xenon-Arc, Continuous Light. All other values are calculated (see 32.18).

**Table III—Classification by AATCC Blue Wool Lightfastness Standards^a
Test Specimen Color Change**

Less Than Standard	Equal To But Not Greater Than Standard	More Than Standard	Lightfastness Class	AATCC Fading Units (AFU)
—	—	L2	L1	
—	L2	L3	L2	5
L2	—	L3	L2-3	
—	L3	L4	L3	10
L3	—	L4	L3-4	
—	L4	L5	L4	20
L4	—	L5	L4-5	
—	L5	L6	L5	40
L5	—	L6	L5-6	
—	L6	L7	L6	80
L6	—	L7	L6-7	
—	L7	L8	L7	160
L7	—	L8	L7-8	
—	L8	L9	L8	320
L8	—	L9	L8-9	
—	L9	—	L9	640

^a The following are examples for using Table III to assign lightfastness classifications:

The test specimen is exposed simultaneously with standards L4, L5, and L6. After exposure and conditioning, the color change exhibited by the test specimen is less than that exhibited by the standards L4 and L5 but greater than that exhibited by the standard L6. The test specimen would be assigned a Lightfastness Classification of L5-6, or use the following example.

The test specimen is examined after each exposure increment until it exhibits a color change equal to Step 4 on the AATCC Gray Scale for Color Change. If this occurs after 40 AFU and before 80 AFU exposure, the test specimen would be assigned a Lightfastness Classification of L5-6.

11.1.1 Visual Comparison—equals the change in color exhibited by the L4 Standard of Fade applicable to the Lot designation used.

11.1.2 Instrumental Color Measurement—for Lot 5, AATCC Blue Wool Lightfastness Standard, equals 1.7 ± 0.3 CIELAB units of color change as determined by AATCC Evaluation Procedure 6. Other Lot designations of AATCC Blue Wool Lightfastness Standard L4 equals the CIELAB units of color change specified on the calibration certificate supplied with the standard as determined by AATCC Evaluation Procedure 6.

11.2 Alternate for Carbon-Arc Options 1 and 2; Xenon-Arc Options 3 and 4, the L2 AATCC Blue Wool Lightfastness Standard may be exposed at the specified temperature, humidity and selected option for 20 ± 2 continuous light-on operating hours. After exposure, assess the exposed standard specimen, either instrumentally or compare to a L2 Standard of Fade. When required, increase or decrease the wattage of the lamps, or the time of exposure, or both, and expose additional standard specimens until the change in color of the exposed standard meets one of the following criteria.

11.2.1 Visual Comparison—equals the change in color exhibited by the L2 Standard of Fade applicable to the Lot designation used (see 32.5).

11.2.2 Instrumental Color Measurement—for Lot 8, AATCC Blue Wool

Lightfastness Standard L2, equals 7.24 ± 0.70 CIELAB units of color change as determined by AATCC Evaluation Procedure 6. Other Lot designations of AATCC Blue Wool Lightfastness Standard L2 equal the CIELAB unit of color change specified on the calibration certificate supplied with the standard as determined by AATCC Evaluation Procedure 6.

NOTE: The Xenon Reference fabric is discontinued for calibration since it is temperature sensitive. It is more appropriately used to monitor test chamber temperature conformance (see Sections 12, 32.3, 32.4 and 32.6).

12. Verification of Test Chamber Temperature by Xenon Reference Fabric, Xenon-Arc Options

12.1 Expose the Xenon Reference Fabric for 20 ± 2 continuous light-on operating hours at the specified temperature, humidity and selected option. Assess the exposed standard specimen, either visually or instrumentally, by one of the following:

12.1.1 Visual Comparison—If the color change of the exposed standard specimen equals the Xenon Reference Fabric Standard of Fade in 20 ± 2 continuous light-on operating hours the test equipment is maintaining the correct temperature.

12.1.2 Instrumental Color Measure-

ment—If the exposed standard specimen equals 20 ± 1.7 CIELAB units of color change in 20 ± 2 continuous light-on operating hours, the test machine is providing the correct temperature.

12.2 If the exposed Xenon Reference Fabric differs visually, or instrumentally, from that specified in 12.1.1 or 12.1.2, as applicable, after 20 ± 2 continuous light-on operating hours, it is an indication that temperature sensing units within the test chamber are not calibrated or responding correctly, or that the test equipment requires maintenance. Verify the accuracy of the temperature sensors and that all machine functions are operating correctly according to the manufacturer's instructions. Replace temperature sensors if they are defective.

13. AATCC Fading Unit Measurement by AATCC Blue Wool Lightfastness Standards

13.1 The use of AATCC Blue Wool Lightfastness Standards and AATCC Fading Units provides a common exposure standard across the various exposure methods: daylight, carbon-arc lamp and xenon-arc lamp. The terms *clock hours* and *machine hours* are not valid reporting methods.

13.2 Table II illustrates the number of AATCC Fading Units to produce a color change equal to Step 4 on the Gray Scale for Color Change on each of the AATCC Blue Wool Lightfastness Standards.

13.3 For instrumental color measurement, the colorimetric data are calculated using CIE 1964 10° observer data for Illuminant D₆₅. Express the color difference in CIELAB units as directed in AATCC Evaluation Procedure 6. NOTE: For Xenon-Arc, Alternating Light and Dark, Option 4, although calibration is conducted using continuous light-on operating hours, it may take more or less operating hours during the actual test cycle due to the inclusion of the dark periods.

14. AATCC Fading Unit Measurement based on Spectral Irradiation, Xenon-Arc, Options 3 and 4 only

14.1 For Options 3 and 4, 20 AATCC Fading Units are produced by an exposure interval of 85 kJ/(m²nm) measured at 420 nm when xenon-arc machines are operated at the conditions specified in this test method (see Table II).

Machine Exposure Procedures, Options 1-5

15. Machine Exposure, General Conditions

15.1 Specimen Mounting. Mount the framed test material on the specimen rack. Make sure that all materials are ade-

quately supported, both top and bottom, in proper alignment. Any displacement of the material toward or away from the source, even by a small distance, may lead to variation in fading between specimens (see 8.2). The specimen rack must be filled; card stock is used when the number of specimens being tested is insufficient to fill the specimen rack. When alternate light and dark cycles are required, begin exposure at the start of the light cycle.

15.2 In the case of woven, knitted and nonwoven fabrics, unless otherwise specified, ensure that the side normally used as the face is directly exposed to the radiant source.

15.3 Operate the test apparatus on a daily basis until the selected exposure has been completed. Avoid unnecessary delays when interrupting the exposure period to change filters, carbons or lamps, as such delays may contribute to variations in results or lead to errors. When available, monitor exposure test chamber conditions with suitable recorders. If necessary, readjust the controls to maintain the specified test conditions. Verify calibration of the test apparatus during the test cycle (see Sections 10, 11, 12 and 13).

16. Machine Exposure to a Specified Amount of Radiant Energy, Options 1-5

16.1 One-Step Method—Expose the test specimens and applicable standards for 5, 10, 20 or multiples of 20 AATCC Fading Units until the specimen has been exposed to the desired amount of radiant energy defined in terms of AATCC Fading Units measured by simultaneous exposure of the appropriate Blue Wool Standard(s).

16.2 Two-Step Method—Proceed as directed in 16.1, except double the exposure area of the test specimens. After the specimen has been exposed to the first specified level of radiant energy, remove the specimens from the test chamber and mask (cover) one-half of the exposed area and continue the exposure for an additional 20 or multiples of 20 AATCC Fading Units until the specimen has been exposed to the higher desired amount of radiant energy.

16.3 In those machines equipped with irradiation monitors, the AATCC Fading Units of exposure can be determined and controlled by measuring $\text{kJ}/(\text{m}^2\text{nm})$ at 420 nm (see 14.1 and Table II).

NOTE: The two-step method is preferred for the complete characterization of the lightfastness of a test specimen.

17. Machine Exposure using a Reference Specimen, Options 1-5

17.1 Expose the test specimen(s) and reference specimen(s) simultaneously to

the required end point in terms of AATCC Fading Units, kilojoules per square meter of irradiance or reference specimen performance (that is, the reference specimen shows a color change equal to Step 4 on the Gray Scale of Color Change).

18. Machine Exposure for Lightfastness Classification

18.1 One-Step Method—Expose test specimen(s) simultaneously with a series of AATCC Blue Wool Lightfastness Standards or determine the number of AATCC Fading Units required to produce a color change in the test specimen equal to Step 4 on the Gray Scale for Color Change (see 32.22).

18.2 Two-Step Method—Proceed as directed in 18.1, except double the exposure area of the test specimens. After the specimen has been exposed to a color change equal to Step 4 on the Gray Scale for Color Change, remove the specimens from the test chamber and mask (cover) one-half of the exposed area and continue the exposure until the test specimen exhibits a color change equal to Step 3 on the Gray Scale for Color Change (see 32.22).

Daylight Behind Glass

19. Daylight Behind Glass, General Conditions, Option 6

19.1 Mount the AATCC Blue Wool Lightfastness Standard(s) and the test specimen(s) on cardboard with an opaque cover (mask) covering one-half of the standard.

19.2 Expose standards and test specimen(s) simultaneously to the same test conditions behind glass (see 32.14 and Appendix B). Ensure that the face of the exposed standard(s) and test specimen(s) are at least 75.0 mm (3.0 in.) below the inside surface of the plate glass cover and are positioned at least 150.0 mm (6.0 in.) in from the edges of the glass frame. The back of the exposure cabinet may be varied as follows to achieve the desired exposure conditions:

Backing	Exposure Condition
Open	Low Temperature
Expanded Metal	Medium Temperature
Solid	High Temperature

Standard(s) and specimen(s) remain exposed 24 h a day and are removed only for inspection.

19.3 Monitor temperature and relative humidity in the vicinity of the test cabinets (see 32.21).

20. Daylight Behind Glass Exposure to a Specified Amount of Radiant Energy

20.1 Use of AATCC Blue Wool Lightfastness Standards—Mount reference and

test specimen(s) to be exposed as directed in 19.1 and expose simultaneously to the same test conditions behind glass as directed in 19.2. Monitor the effect of light by frequently removing the standard(s) from the test frame and evaluating the color change. Continue the exposure until the standard exhibits a difference in color between the exposed and masked portion as described in Section 24. When the test of the specimens is to be terminated after exposure to a specified number of AATCC Fading Units, choose the appropriate standard to achieve the end point. The standards may be used as a set, L2 through L9, or in replicate sets exposed consecutively to total a given end point; that is, singularly expose two L2 standards to reach 10 fading units, or expose one L3 standard to reach 10 fading units.

20.1.1 Remove the samples from exposure when the desired AATCC Fading Units have been achieved and evaluate as specified in Evaluation of Results. For multiple step exposure, that is, 5 fading units and 20 fading units, a single sample may be exposed and portions covered (masked) at intervals measured by the standard. The result will be a sample having an original masked, unexposed section and various sections which have been exposed and subsequently masked. Each section of the specimen, representing a stated exposure interval, can be evaluated versus masked control or an unexposed original portion of the sample.

20.2 Use of Irradiation Monitors—Mount reference and test specimen(s) to be exposed as directed in 19.1 and expose them simultaneously to the same test conditions behind glass as directed in 19.2.

NOTE: The exposure of the AATCC Blue Wool Lightfastness Standards with their known performance can be helpful in determining whether any unusual conditions were present during the test duration (see 32.16).

20.2.1 Record any one, or a combination of global, broad bandpass, or narrow bandpass irradiation with a radiometer, exposed under the same conditions as the specimens (see 32.17).

20.2.2 Remove the reference and test specimens from exposure when the desired radiant energy, as measured by the radiometer, has been achieved. For multiple step exposure, a single sample may be exposed and portions covered (masked) at intervals of measured radiant exposure (see 20.1.1).

21. Daylight Exposure Using a Reference Specimen

21.1 Substitute reference specimen(s) for the AATCC Blue Wool Lightfastness Standards and proceed as directed in 20.1 and 20.2, as applicable.

22. Daylight Exposure for Lightfastness Classification

22.1 One-Step Method—Expose test specimen(s), as detailed in 19.1 and 19.2, simultaneously with a series of AATCC Blue Wool Lightfastness Standards or determine the number of AATCC Fading Units required to produce a color change in the test specimen equal to Step 4 on the Gray Scale for Color Change (see 32.22).

22.2 Two-Step Method—Proceed as directed in 22.1, except double the exposure area of the test specimens. After the specimen has been exposed to a color change equal to Step 4 on the Gray Scale for Color Change, remove the specimens from the test chamber and mask (cover) one-half of the exposed area and continue the exposure until the test specimen exhibits a color change equal to Step 3 on the Gray Scale for Color Change (see 32.22).

Evaluation of Results

23. Conditioning

23.1 After the test exposure is completed, remove the test specimens and comparison standards from exposure. Condition in a dark room at standard conditions for testing textiles, as directed in ASTM D 1776, Standard Practice for Conditioning and Testing Textiles. [$65 \pm 2\%$ RH and $21 \pm 1\text{C}$ ($70 \pm 2\text{F}$)] for a minimum of 4 h before evaluation.

24. Assessment of Color Change

24.1 Compare the exposed portion to the masked control or to an unexposed original portion of the specimen, as specified in a material specification or purchase order. Complete characterization of the lightfastness of a test specimen requires evaluation at more than one level of exposure (see 32.15).

24.2 Quantify the color change using either the AATCC Gray Scale for Color Change (preferred), or by colorimetric measurement of color difference at the specified exposure level whether in AATCC Fading Units, kilojoules of radiant energy, or compared to a reference standard (see 32.22).

24.3 Determine total color difference (ΔE_{CIELAB}) and the difference in lightness, chroma, and hue (ΔL^* , ΔC^* , ΔH^*). Use instruments that provide values based on the CIE 1976 equation using illuminant D_{65} and 10° observer data. For instruments with diffuse geometry, include the specular component of reflectance in the measurements (refer to AATCC Evaluation Procedure 6, Instrumental Color Measurement).

25. Acceptance Based on Simultaneous Exposure of a Reference Specimen

25.1 Assess color change of the mate-

rial as directed in Section 24 in terms of the agreed upon reference specimen.

25.2 Assess the lightfastness of the material as follows:

25.2.1 Satisfactory—If the test specimen exhibits a color change equal to or less than the reference specimen at the exposure level when the reference specimen shows a color change equal to Step 4 on the AATCC Gray Scale for Color Change.

25.2.2 Unsatisfactory—If the test specimen exhibits a color change greater than the reference specimen at the exposure level when the reference specimen shows a color change equal to Step 4 on the AATCC Gray Scale for Color Change.

26. Classification Based on the AATCC Blue Wool Lightfastness Standards

26.1 One Step Exposure—Classify lightfastness of the material by:

(a) comparison of the color change of the test specimen to that of a simultaneously exposed series of AATCC Blue Wool Lightfastness Standards (see Table III), or

(b) determination of the number of AATCC Fading Units required to produce a color change in the test specimen equal to Step 4 of the Gray Scale for Color Change (see Table II).

26.2 Two Step Exposure—Classify lightfastness of the material by:

(c) determination of the number of AATCC Fading Units required to produce color changes in the test specimen equal to both a Step 4 and Step 3 on the AATCC Gray Scale for Color Change (see Table II).

26.2.1 Assign both classifications: the

Step 3 level appears first, followed by the Step 4 level in parentheses. For example, a L5(4) classification would illustrate a L5 classification at Step 3 color change and a L4 classification at Step 4 color change. When only one classification number is assigned, it shall represent the number of AATCC Fading Units to produce a Step 4 color change.

27. Classification above L7 AATCC Blue Wool Lightfastness Standard

27.1 Using Table IV, classify lightfastness above the L7 AATCC Blue Wool Lightfastness Standard according to the total number of consecutive L7 standards exposed to Step 4 on the Gray Scale for Color Change during the exposure cycle that is required to produce a Step 4 color change on the test specimen, and Table IV.

28. Report

28.1 Use Table V to report all applicable information.

28.2 Report any deviation from Test Method 16 or the performance of the reference standard.

28.3 Report all information in Table V for the same conditions that the samples and reference materials are exposed.

Precision and Bias

29. Precision

29.1 In 2002 a single laboratory study was performed using a single operator. This study was intended to be a temporary table of variances to give some indication of test variability. A complete interlaboratory study is to be conducted in

Table IV—Classification by AATCC Blue Wool Lightfastness Standards Above L7

Number of L7 Standards Exposed			Lightfastness Class	Equivalent AATCC Fading Unit (AFU)
Less Than	Equal To But Not Greater Than	More Than		
—	2	—	L8	320
3	—	2	L8-9	—
—	3	—	L8-9	480
4	—	3	L8-9	—
—	4	—	L9	640
5	—	4	L9-10	—
—	5	—	L9-10	800
6	—	5	L9-10	—
—	6	—	L9-10	960
7	—	6	L9-10	—
—	7	—	L9-10	1120
8	—	7	L9-10	—
—	8	—	L10	1280
etc. ^a	etc. ^a	—	etc. ^a	etc. ^a

^a A classification increase of 1 represents the interval when the equivalent AATCC Fading Units are doubled from the previous whole number classification. Any test specimen for which the number of L7 Standards fall between two whole number classifications is assigned both the lower and higher classification defining that interval.

Table V—Reporting Form

Operator's Name _____ Date _____

Sample Identification _____

Material Exposed: Face _____ Back _____

Colorfastness to Light Rating _____ Lightfastness Classification _____

Acceptance Compared to Reference Sample (Yes/No) _____

Test Specimen Compared To: Masked Portion _____

Unmasked Portion _____ Unexposed Original _____

Colorfastness to Light Rating determined by:

AATCC Gray Scale for Color Change _____

Instrumentally, Name Type _____

Classification Method _____

Reference Standard _____

Temperature Controlled By: Ambient (Dry Bulb) _____ °C

Black Panel _____ °C Black Standard _____ °C

Exposure Controlled By: AATCC Blue Wool Lightfastness Standards _____

Radiant Energy _____ Other _____

Total Radiant Energy _____

Type of Test Apparatus _____ Model No. _____

Serial No. _____ Manufacturer's Name _____

Specimen Rack: Inclined _____ 2-Tier _____ 3-Tier _____ Horizontal _____

Type of Water Supply _____

Option Employed _____ Elapsed Exposure Time _____

Mounting Procedure: Backed _____ Unbacked _____

Sample Rotation Schedule _____ % Relative Humidity _____

For Option 6 only report the following:

Geographical Location _____

Exposure Dates: From _____ To _____

Exposure Latitude _____ Exposure Angle _____

Exposed Behind Window Glass: Yes/No _____ If Yes, Specify Type _____

Daily Ambient Temperature: Minimum _____ °C Maximum _____ °C Avg. _____ °C

Daily Black Panel Temperature: Minimum _____ °C Maximum _____ °C Avg. _____ °C

Test Environment Temperature: Minimum _____ °C Maximum _____ °C Avg. _____ °C

Daily % Relative Humidity: Minimum _____ Maximum _____ Avg. _____

Hours of Wetness: Rain _____ Rain and Dew _____

the near future for the purposes of precision and bias. Table values do not reflect different types of material tested to this standard. *Between-Laboratory* variability is not indicated either. Special care and consideration of the variances reported must be used when examining test variability problems.

29.1.1 Samples tested consisted of four fabrics, with three replicates each. Exposure conditions were those found in Option 3 of this method. Each sample was evaluated instrumentally three times and averages were calculated. The data is found in Table VI.

29.1.2 *Within-laboratory* standard errors and Sample Variance are shown in Table VII. Data is on file at the AATCC Technical Center.

30. Bias

30.1 The colorfastness to natural and artificial light can be defined only in terms of a test method. There is no independent method for determining the true value. As a means of estimating this property, the method has no known bias.

31. References

31.1 AATCC Evaluation Procedure 1, Gray Scale for Color Change (see 32.5).

31.2 AATCC Evaluation Procedure 6, Instrumental Color Measurement (see 32.5).

31.3 ASTM G 151, Standard Practice for Exposing Nonmetallic Materials in Accelerated Test Devices that Use Laboratory Light Sources.

31.4 ASTM G 153, Standard Practice for Operating Enclosed Carbon-Arc Light Apparatus for Exposure of Nonmetallic Materials (see 32.19).

31.5 ASTM G 24, Standard Practice for Conducting Exposures to Daylight Filtered through Glass (see 32.19).

31.6 ASTM G 155, Standard Practice for Operating Xenon-Arc Light Apparatus for Exposure of Nonmetallic Materials (see 32.19).

31.7 ISO 105, Part B, Textiles—Tests for Colorfastness (see 32.20).

32. Notes

32.1 AATCC Blue Wool Lightfastness Standards, except L2, are specially prepared by blending varying proportions of wool dyed with a very fugitive dyestuff, Erio Chrome Azurole B (C.I. 43830) and wool dyed with a fast dyestuff, Indigosol Blue AGG (C.I. 73801). Each resultant higher numbered standard is twice as colorfast as the preceding numbered standard. AATCC Blue Wool Lightfastness Standards and the ISO numbered Blue Wool Lightfastness Standards (as used in ISO 105-B01) produce different ratings and therefore cannot be used interchangeably (see 32.5).

32.2 Black Thermometers are used to control an artificial weathering device and to provide an estimate of the maximum temperature of samples exposed to a radiant energy source. There are two types of Black Thermometers. One type is referred to as a "Black Panel Thermometer" which is uninsulated and is made of metal. The other type is referred to as a "Black Standard Thermometer" which is insulated and is made of metal with a plastic backing. As a point of information, some ISO specifications specify the use of a "Black Standard Thermometer." Typically, Black Standard Thermometers indicate higher temperatures than Black Panel Thermometers under the same exposure conditions.

The Black Thermometer units indicate the absorbed irradiance minus the heat dissipated by conduction and convection. Keep the black face of these thermometer units in good condition. Follow the manufacturer's recommendations for proper care and maintenance of Black

Thermometers.

32.2.1 For Black Panel Thermometers: Testing temperature is measured and regulated by a Black Panel Thermometer unit mounted on the specimen rack to permit the face of it to receive the same exposure as the test specimen. Black Panel Thermometers shall consist of a metal panel at least 70 × 150 mm and not less than 45 × 100 mm whose temperature is measured with a thermometer or thermocouple whose sensitive portion is located in the center of and in good contact with the panel. The side of the panel facing the light source shall be black with a reflectance of less than 5% throughout the spectrum of light reaching the specimen; the side of the panel not facing the light source shall be open to the atmosphere within the exposure chamber.

32.2.2 For Black Standard Thermometers: Testing temperature is measured and regulated by a black standard thermometer unit mounted on the specimen rack to permit the face of it to receive the same exposure as the test specimen. The Black Standard Thermometer shall consist of a plane of stainless steel plate measuring 70 × 40 mm with a thickness of about 0.5 mm, whose temperature is measured by a thermal resistor, with good heat-conducting properties, fitted to the reverse side. The metal plate is fixed to a plastic plate so that it is thermally insulated. The side of the panel facing the light source shall be black with a reflectance of less than 5% throughout the spectrum of light reaching the specimen.

32.3 The Xenon Reference Fabric is a knit of 150 denier textured polyester yarn in a double pique stitch, dyed to a purple shade with 1.8% of 2,4-dinitro-6-bromo-2-amino-4-(N,N-diethylamino) azobenzene at 129°C (265°F) for 1 h and then heat set at 179°C (335°F) for 30 s (see 32.6).

32.4 More uniform and reproducible fading of the AATCC Blue Wool Lightfastness Standards, Xenon Reference Fabric, and test specimens is achieved when backed with white cardboard. The color difference values in the initial determination of the end point for both the Xenon Reference Fabric and the AATCC Blue Wool Lightfastness Standards were determined from exposures with such backing. Although tolerances are given for both the AATCC Blue Wool Lightfastness Standards and Xenon Reference Fabric, every effort should be made to achieve the midpoint value given for these standards. For referee purposes, the Xenon Reference Fabric and AATCC Blue Wool Lightfastness Standards will be exposed in multiples of three and the average color difference in the case of the Xenon Reference Fabric will be 20 CIELAB units and in the case of the AATCC Blue Wool Lightfastness Standards will be 1.7 CIELAB units.

32.5 Available from AATCC, P.O. Box 12215, Research Triangle Park NC 27709; tel: 919/549-8141; fax: 919/549-8933; e-mail: orders@aatcc.org.

32.6 The Xenon Reference Fabric Standard of Fade is used as a visual or instrumental reference for test chamber temperature verification. The measured instrumental color difference value will be shown on each standard of fade. The Xenon Reference Fabric is sensitive to temperature as shown in Table VIII.

32.7 Precut white card stock for backing test specimens is available from SDL Atlas

Table VI— ΔE

	Brown #1	Brown #2	Green	Blue
Sample 1	0.61	1.05	2.41	2.04
Sample 2	0.92	1.16	3.18	2.65
Sample 3	0.56	1.79	2.59	2.1
Average	0.697	1.333	2.727	2.263

Table VII—Within-Laboratory Standard Errors and Sample Variance

Sample Identification	Standard Dev.	Standard Error	Sample Variance	95% Confidence
Brown #1	0.195	0.1125956	0.0380333	0.4844603
Brown #2	0.399	0.2305308	0.1594333	0.9918946
Green	0.403	0.2325463	0.1622333	1.0005666
Blue	0.336	0.1941076	0.1130333	0.8351784

*Note: Because the interlaboratory test included less than five laboratories, estimates of standard error and sample variance may be either underestimated or overestimated to a considerable extent and should be used with special caution. The values should be viewed as minimal data with regards to precision. Confidence intervals are not well established.

Table VIII—Temperature vs. Color Change, Xenon Reference Fabric^a

Black-Panel Temperature	ΔE (CIELAB)
58°C	16.0
63°C	20.0
68°C	23.8

^a see Note 32.9.

L.L.C., 1813A Associate Lane, Charlotte NC 28217; tel: 704/329-0911; fax: 704/329-0914; e-mail: info@sdlatlas.com. Comparable white card stock (9016 White Bristol Index) is also available from stationery stores and dealers in artist's supplies.

32.8 Test masks made with white paper, 0.005-0.006 inches thick, with a dull black coating that provides zero light transmittance to the specimen are available from SDL Atlas L.L.C., 1813A Associate Lane, Charlotte NC 28217; tel: 704/329-0911; fax: 704/329-0914; e-mail: info@sdlatlas.com.

32.9 One or more of the test apparatus types and materials are available from: SDL Atlas L.L.C., 1813A Associate Lane, Charlotte NC 28217; tel: 704/329-0911; fax: 704/329-0914; e-mail: info@sdlatlas.com; and Suga Test Instrument Co., 4-14 Shinjuku, 5-Chome, Tokyo 160, Japan; tel: +81(3) 3354-5241; fax: +81(3) 3354-5275.

32.10 Available from William Harrison Co., 4595 E. 10th Ct., Hialeah FL 33013; tel: 305/681-8381.

32.11 Pile fabric, such as carpets, which have fibers that may shift position, or texture which may make evaluations in small areas difficult should be tested with an exposed area of not less than approximately 40.0 × 50.0 mm (1.6 × 2.0 in.). Expose sufficient size or multiple specimens to include all colors in the sample.

32.12 Sample frames must be made of stainless steel, aluminum, or suitably coated steel to avoid contaminating the specimens with metallic impurities that might catalyze or inhibit the degradation. When samples are fastened with staples, they should be of the nonferrous type overcoated to avoid contamination of the specimen by corrosion products. Metal frames must have a dull finish and be designed to avoid reflectances that could influence the performance of the material. Frames shall conform to the curvature of the specimen rack. The size of the frame is determined by the type specimens required for individual property requirements.

32.13 In Table C1, the data are for a typical spectral power distribution for an enclosed carbon-arc with a borosilicate glass globe. The daylight data are for global irradiance on a horizontal surface with an air mass of 1.2, column ozone 0.294 atm cm, 30% relative humidity, altitude 2100 m (atmospheric pressure of 787.8 mb), and an aerosol represented by an optical thickness of 0.081 at 300 nm and 0.62 at 400 nm. Data from 701-800 nm is not shown.

The following references provide background information on radiation measurements by Light Control Systems:

32.13.1 *Handbook of Chemistry & Physics*,

61st Edition, 1980, edited by Robert C. Weast; The Chemical Rubber Co., Cleveland OH.

32.13.2 International Commission on Illumination (CIE) Publication No. 20, 1972.

32.13.3 *Atlas Sun Spots*, Vol. 4, No 9, Spring 1975, Atlas Material Testing Technology LLC, Chicago, IL.

32.14 Window glass of the desired quality is available from such dealers as: Libby-Owens-Ford Glass Co., Toledo OH, 2.0 mm flat drawn sheet glass, single strength, quality B; or Pittsburg Plate Glass Co., Pennvernon sheet glass, single strength, quality B, or equivalent.

32.14.1 In order to reduce variability due to changes in UV transmission of glass, all new glass shall be exposed facing the equator, at the site latitude angle, or on an empty under glass exposure cabinet, for at least three months prior to installation in test cabinets.

32.14.2 After the three-month exposure period, it is recommended that the spectral transmittance of representative samples from each lot of glass be measured. Typically "single strength" glass will have a transmittance of 10-20% at 320 nm and at least 85% at wavelengths of 380 nm or higher after the three-month pre-aging procedure. If transmittance of the glass is measured, report the average for at least three pieces of the lot of glass being tested. Follow the instructions for measurement of transmittance of solid samples recommended by the manufacturer of the UV-visible spectrophotometer used. If a spectrophotometer with an integrating sphere is used, the measurements shall be performed in accordance with ASTM E 903, Test Method for Solar Absorptance, Reflectance, and Transmittance of Materials Using Integrating Spheres. Additional information on this subject is contained in the following ASTM paper by W. D. Ketola and J. S. Robbins: "UV Transmission of Single Strength Window Glass," *Accelerated and Outdoor Durability Testing of Organic Materials*, ASTM STP 1202, Warren D. Ketola and Douglas Grossman, Eds., American Society for Testing and Materials, Philadelphia, 1993.

32.15 A difference in color between original material and the covered portion of the exposed specimen indicates that the textile has been affected by some agent other than light, such as heat or a reactive gas in the atmosphere. Although the exact cause of this difference in color may not be known, it should be noted in the report when it occurs.

32.16 In some cases high humidity, in combination with atmospheric contaminants, has been found to produce color changes as great as those produced by light. When requested, prepare a duplicate set of test specimens and standards mounted on cardboard, but not masked, and expose simultaneously in another cabinet of the same type used in the light exposures but with the glass covered with an opaque material so that the light is excluded. Since there is a combined effect of light, temperature, humidity and atmospheric contaminants, it cannot be assumed that a comparison between specimens exposed in the covered cabinet and in the uncovered cabinet under glass will permit separating the effects produced by light only. However, a comparison of the two sets of specimens with a piece of the original which has not been in an exposure cabinet will indicate whether a material is sensitive to moisture and atmospheric contaminants. This may also help to explain why

different results may be obtained with the same amount of radiant energy in daylight exposures made at different times and in different locations.

32.17 The Eppley PS-P black and white pyranometer has been found suitable for measuring total daylight radiant energy, and the Eppley Broad Band-Pass Ultraviolet Radiometer has been found suitable for measuring the radiant energy from 295-385 nm of daylight. These instruments are available from Eppley Laboratory, 12 Sheffield Ave., Newport RI 02840; tel: 401/847-1020. The Atlas LM-3A narrow band-pass radiometer has been found suitable for measuring radiant energy at 340 or 420 nm of daylight and is available from SDL Atlas L.L.C., 1813A Associate Lane, Charlotte NC 28217; tel: 704/329-0911; fax: 704/329-0914; e-mail: info@sdlatlas.com. The Radialux broad bandpass radiometer has been found suitable for measuring radiant energy from 300-400 nm of daylight and is available from SDL Atlas L.L.C., 1813A Associate Lane, Charlotte NC 28217; tel: 704/329-0911; fax: 704/329-0914; e-mail: info@sdlatlas.com.

32.18 Interlaboratory Test Summary—Committee RA50 has conducted extensive studies to evaluate the use of radiation monitoring devices to terminate exposures in lightfastness testing. Data has been collected in interlaboratory studies using controlled irradiance, xenon-arc equipment and in daylight exposures conducted during a two-year period in both Arizona and Southern Florida. In both studies, one laboratory conducted instrumental measurement of the color change for all exposed specimens.

The interlaboratory studies were undertaken, using eight different lightfastness standard fabrics, to determine the definition of 20 AATCC Fading Units in terms of measured radiation. These studies showed that acceptable agreement between laboratories can be obtained for lightfastness testing providing the following variables are controlled: irradiance level, black-panel temperature, ambient temperature and relative humidity. Overall, there was less than 10% variability in the instrumentally determined color change of specimens exposed in different laboratories. For all specimens tested the standard deviation was equivalent to less than one-half step on the Gray Scale for Color Change. As a result of these tests, 20 AATCC Fading Units was established at 85 KJ/(m²nm) when measured at 420 nm (approximately 21.5 continuous light-on operating hr) when tested at the conditions specified for Xenon-Arc Lamp, Continuous Light, Option 3

For the daylight studies, 16 different fabrics, in addition to AATCC and ISO Blue Wool Lightfastness standard fabrics, were exposed. An exposure series was begun each quarter year at two locations over a two-year period. Exposures were terminated based on instrumental measurement of radiant energy dosage. A wide variation in climatic conditions was encountered during the test period. The data obtained clearly shows that the color change of individual specimens is affected differently by variations in temperature, humidity, atmospheric contaminants, etc.; however, the single most significant variable is radiation. The variation in color change resulting from exposure during different years, locations, and seasons, averaged ± 30%.

A more detailed summary of these test results was presented to the 14th meeting of ISO, Technical Committee 38, Subcommittee 1 as Document 38/1 N 993, USA Report on Monitoring of Radiation during Lightfastness Testing.

32.19 Available from ASTM, 100 Barr Harbor Dr., West Conshohocken PA 19428; tel: 610/832-9500; fax: 610/832-9555.

32.20 Available from American National Standards Institute, Inc., 11 W. 42nd St., 13th FL., New York NY 10036; tel: 212/642-4900; fax: 212/302-1286.

32.21 For measuring temperature and relative humidity of the air under the same conditions that the samples and reference materials are exposed and in the vicinity of test cabinets, any suitable indicating or recording instrument may be used. Continuous recording of temperature and relative humidity is preferred.

32.22 An automated electronic grading system may be used as long as the system has been demonstrated to provide results that are equal to and provide equal or better repeatability and reproducibility than an experienced grader performing visual evaluations.

Appendix A

A. Xenon-Arc Lamp Fading Apparatus

A1 Different types of xenon-arc test apparatus may be utilized provided that the test apparatus is capable of automatically controlling irradiance level, humidity level, chamber air temperature, and Black Panel or Black Standard Thermometer temperature.

A2 The design of the test chamber may vary, but it should be constructed from corrosion resistant material.

A3 Xenon-Arc Light Source. The xenon-arc test apparatus utilizes a long-arc quartz-jacketed xenon-arc lamp as the source of irradiance which emits radiation from below 270 nm in the ultraviolet through the visible spectrum and into the infrared.

While all of the xenon-arc lamps are of the same general type, different size lamps operated in different wattage ranges are employed in several sizes and types of apparatus. In each of the various models, the diameter and height of the specimen rack varies according to the lamp size and the wattage at which it is operated to provide an irradiance at the face of the specimen of $1.10 \pm 0.03 \text{ W}/(\text{m}^2\text{nm})$ measured at 420 nm or equivalent when exposed in standard holders.

A3.1 Aging of the xenon burners or filters can result in changes in lamp spectrum. Changes in lamp spectrum may also be caused by accumulation of dirt or other residue in or on the burner envelope.

A3.2 Filter—In order for xenon-arcs to simulate terrestrial daylight, filters must be used to remove short wavelength UV radiation. In addition, filters to remove infrared radiation may be used to prevent unrealistic heating of test specimens that can cause thermal degradation not experienced during outdoor exposures. Filters to reduce irradiance at wavelengths

shorter than 310 nm must be used to simulate daylight filtered through window glass.

The instrument manufacturers' recommendations should be used to provide the appropriate spectrum (see A3.4 below). Replace filters when chipped, cracked, or when discoloration or milkiness develops. Discard xenon lamp tubes and filters at the manufacturer's recommended time intervals or sooner, or when 20 AATCC Fading Units can no longer be attained in 20 ± 2 continuous light-on operating (clock) hours.

A3.3 Spectral Irradiance of Filtered Xenon-Arc—Figure A1 shows the desired relative spectral power distribution for filtered xenon-arcs comply with these limits. The acceptable limits for variation of the relative spectral power distribution shown in Fig. A1 are on file at the AATCC Technical Center.

A3.4 Follow the device manufacturer's instructions for recommended maintenance.

Appendix B

B. Daylight Exposure Cabinet and Location

B1 The daylight exposure cabinet shall consist of a glass-covered enclosure of any convenient size constructed of metal, wood or other satisfactory material to protect the specimens from rain and weather, and be well ventilated to allow

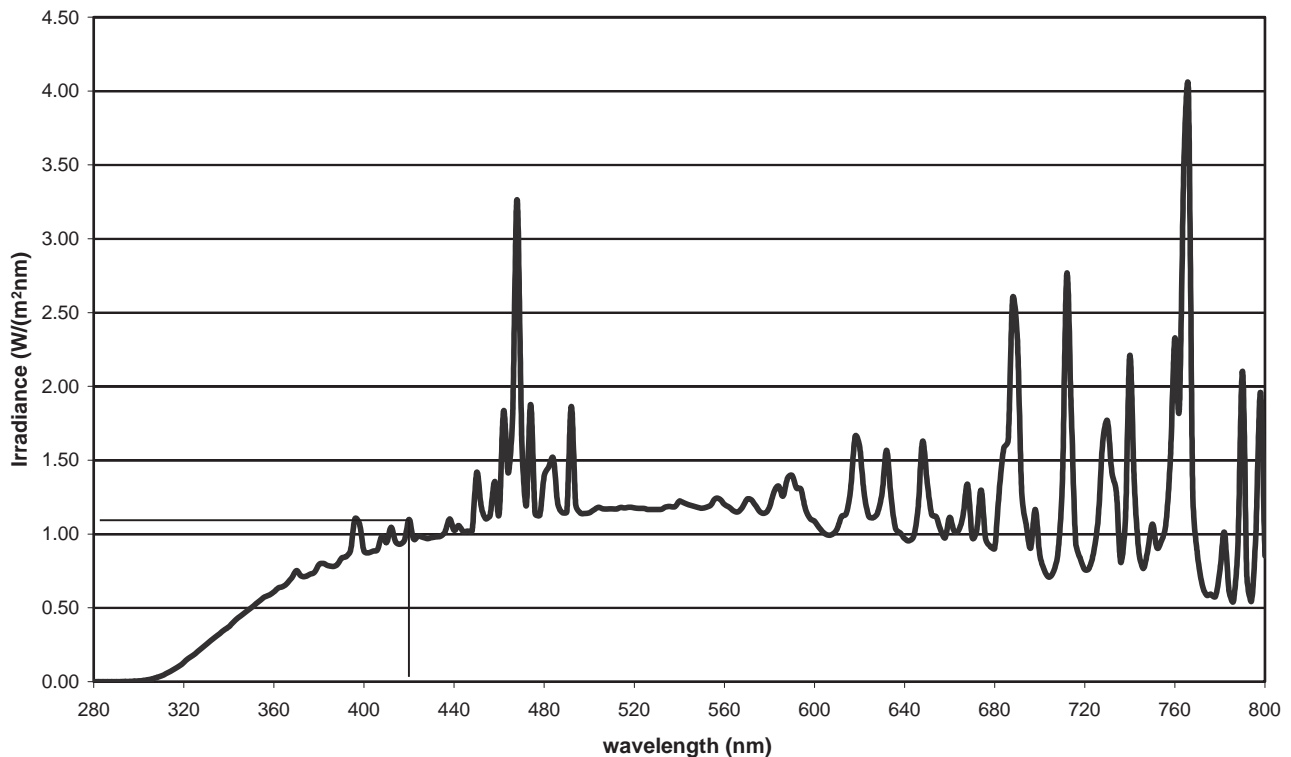

Fig. A1—Filtered Xenon Lamp Spectral Power Distribution Controlled at $1.1 \text{ W}/(\text{m}^2\text{nm})$ at 420 nm

free flow of air over the specimens. The glass cover shall be a sheet 2.0-2.5 mm thick piece of good grade, clear and flat-drawn. It shall be single strength, free of bubbles or other imperfections.

B2 The enclosure or cabinet shall be equipped with a rack which supports the specimens in a plane parallel to that of the glass cover with the face of the specimen at a distance below it of not less than 75.0 mm (3.0 in.). The specimen mounting rack shall be constructed of a material that is compatible with the test specimens. It may be either the open type providing good ventilation on the back side of the specimen, or of a solid material as required. To minimize shadows from the top and the sides of the cabinet, the usable exposure area under glass shall be limited to that of the glass cover reduced by twice the distance from the cover to the specimens.

B3 The cabinet shall be located where it will receive direct daylight throughout the day and where shadows of objects in the vicinity will not fall upon it. When the cabinet is installed over soil, the distance between the bottom of the cabinet and the plane of the cleared area shall be great enough to prevent any undesirable effects of contact with grass or other plant growth during the period of exposure.

B4 The glass cover and the test specimen shall slope toward the equator at an angle from the horizontal equal in degrees to approximately the latitude of the location at which the tests are being made. Other angles of exposure, such as 45° may be used, but the angle must be reported in the results of test.

B5 Exposure cabinets shall be located in cleared areas, preferably at a suitable number of climatologically different sites representing the various conditions under which the material will be used. Major climatological variations include subtropical, desert, seashore (salt air), industrial atmosphere and areas exhibiting a wide range in percentage of available sunshine. The area beneath and in the vicinity of the cabinets should be characterized by low reflectance and be typical of

the ground cover in that climatological area. In desert areas, it should be gravel whereas in most temperature and subtropical areas, it should be low cut grass. The type of ground cover should be indicated in the report.

B6 Instruments for determining climatological data during the exposure period shall be operated in the immediate area of the exposure cabinets. When requested, data obtained shall be reported as part of the results of the test. To characterize the conditions around the test frame, these instruments should be capable of recording: ambient temperature (daily minimum and maximum), relative humidity (daily minimum and maximum), hours of precipitation (rain), and total hours of wetness (rain and dew). To characterize the conditions within the test frame, these instruments should be capable of recording: ambient temperature under glass (daily minimum and maximum), black temperature sensor under glass, total radiant energy and ultraviolet radiant energy (either broad or narrow bandpass) at the same angle of exposure as the test specimens, and relative humidity (daily minimum and maximum) (see 32.17 and 32.21).

Appendix C

C. Enclosed Carbon-Arc Lamp Fading Apparatus

C1. Different types of carbon-arc test apparatus may be utilized. The design of the test chamber may vary, but it should be constructed from corrosion resistant material, and in addition to the radiant source, may provide for means of controlling temperature and relative humidity.

C1.1 Laboratory Light Source—Enclosed carbon-arc light sources typically use carbon rods which contain a mixture of metal salts. An electric current is passed between the carbon rods which burn and give off ultraviolet, visible and infrared radiation. Use carbon rods recommended by the device manufacturer.

C1.2 Filter—The most commonly used

filters are borosilicate glass globes which fit around the carbon burners.

C1.3 The emission spectra of the enclosed carbon-arc shows strong emission in the long wavelength ultraviolet region. Emissions in the visible, infrared and short wavelength ultraviolet below 350 nm are generally weaker than in daylight behind window glass (see Table C1). The enclosed carbon-arc does not provide a good match to natural daylight.

C1.3.1 Spectral Irradiance for Enclosed Carbon-Arc with Borosilicate Filters—Table C1 is representative of the spectral irradiance received by a test specimen mounted in the specimen plane.

C1.4 See 32.13 for additional information.

C1.5 Thermometer—A Black Panel or Black Standard Thermometer may be used and shall conform to the descriptions found in 32.2.1 and 32.2.2. The type of thermometer used, the method of mounting on specimen holder, and the exposure temperature shall be stated in the test report.

C1.6 Relative Humidity—The test chamber may be equipped with a means to measure and control the relative humidity. Such instruments shall be shielded from the light source.

C1.7 Apparatus Maintenance—The test apparatus requires periodic maintenance to maintain uniform exposure conditions. Perform required maintenance in accordance with manufacturer's instructions.

Table C1—Typical Spectral Power Distribution for Enclosed Carbon-Arc with Borosilicate Filters. Ultraviolet Wavelength Region Irradiance as a Percentage of Total Irradiance from 300-400 nm

Bandpass (nm)	Enclosed Carbon-Arc with Borosilicate Filters	Sunlight
290-320	0%	5.6%
320-360	20.5%	40.2%
360-400	79.5%	54.2%

Wetting Agents, Evaluation of

Developed in 1932 by AATCC Committee RA8; jurisdiction transferred in 2003 to AATCC Committee RA63; reaffirmed 1943, 1971, 1977, 1980, 1989, 2005; revised 1952, 1999; editorially revised and reaffirmed 1974, 1985, 1994; editorially revised 1988, 1991, 2004.

1. Purpose and Scope

1.1 This test method determines the efficiency of ordinary commercial wetting agents.

2. Principle

2.1 A weighted cotton test skein is dropped into a tall cylinder containing a water solution of a wetting agent. The time required for a string stirrup connecting the weight and the skein to relax is recorded as the sinking time.

3. Terminology

3.1 **wetting agent**, *n.*—a chemical compound which when added to water lowers both the surface tension of the liquid and its interfacial tension against the solid material.

4. Safety Precautions

NOTE: These safety precautions are for information purposes only. The precautions are ancillary to the testing procedures and are not intended to be all inclusive. It is the user's responsibility to use safe and proper techniques in handling materials in this test method. Manufacturers MUST be consulted for specific details such as material safety data sheets and other manufacturer's recommendations. All OSHA standards and rules must also be consulted and followed.

4.1 Good laboratory practices should be followed. Wear safety glasses in all laboratory areas.

4.2 Wear chemical goggles, rubber gloves and apron in preparing wetting agent stock solution.

5. Apparatus and Materials

5.1 Hooks of standard weight and attached anchors (see 10.1 and 10.2).

5.2 Volumetric flasks, 1000 mL.

5.3 Beaker, 1500 mL.

5.4 Graduated cylinders, 500 mL.

5.5 Bulb pipette (or aspirator), 100 mL.

5.6 Bulb transfer pipettes, assorted sizes.

5.7 Cotton yarn, greige unboiled, 2-ply, in 5-g skeins (see 10.3).

5.8 Water, distilled (see 10.4).

5.9 Graph paper, log-log.

6. Test Solutions

6.1 Stock solutions of the agents to be tested are normally prepared to contain 50.0 g of agent per liter unless the solubility is so poor that less must be employed. The wetting agent is first thoroughly dissolved in about a quarter of the necessary distilled water at a temperature above 80°C and is then diluted to the final volume with cold distilled water. Aliquot portions of 5, 7, 10, 15, 25, 35, 50, 75 and 100 mL of the 5% stock solution taken with delivery bulb pipettes and diluted with suitable water (see 10.4) to 1000 mL correspond, respectively, to concentrations of 0.25, 0.35, 0.50, 0.75, 1.25, 1.75, 2.50, 3.75 and 5.00 g of wetting agent per liter. This range of concentrations is sufficient for the study of any commercial product.

7. Procedure

7.1 The diluted solution for test is poured from the liter volumetric flask into a 1500 mL beaker to ensure mixing. The solution in the beaker is then divided equally between two 500 mL graduated cylinders. If the more dilute solutions are tested first, the mixing beaker and cylinders need not be rinsed out and dried each time. The operator must wait after the cylinders have been filled until all bubbles *below* the surface of the solution have risen to the top before the sinking tests are made. The operator may advantageously prepare solutions for 6 more cylinders while waiting for the bubbles to rise. Foam on the surface of the solution is removed either with a 100 mL bulb pipette or with an aspirator. Where there is little tendency for exhaustion of the wetting agent on the test skeins—practically always true for cotton—it is permissible to use the same diluted solution over again several times rather than to make a new diluted solution for each new skein. In this case only one 500 mL cylinder can be filled repeatedly from one liter of solution of a certain concentration.

7.2 Since temperature often markedly affects wetting, standard temperatures of 25°C, 50°C, 70°C and 90°C have been chosen for testing so as to include the complete commercially useful range. It is most convenient to attain a temperature of 25°C merely by using water which has been brought to the correct temperature in a large pail. For tests at higher temper-

atures, heat the diluted solution for test in the mixing beaker to a temperature somewhat above that required, pour the solution into the cylinder and then allow it to cool back to the testing temperature.

7.3 For a determination, a 5.00 g skein of yarn is folded enough times to form a loop 45.7 cm around. A 91.4 cm skein is most convenient and can be formed into a 45.7 cm loop with only 2 folds; a 137.2 cm skein requires 3 folds; a 182.9 cm skein, 4 folds and a 228.6 cm skein requires 5 folds. The hook with its anchor is fastened at one end of the folded skein and the skein is cut through with shears at the opposite end. The cut skein is drawn through the fingers when testing wetting agents in order to make it more compact. Any threads which have been tied around the skein to correct its weight are folded into the skein near the hook. The skein is held in one hand with the anchor dangling into the wetting solution contained in the 500 mL graduated cylinder. A stopwatch held in the other hand is started just as the skein is released into the solution and it is stopped when the buoyant skein definitely starts to sink to the bottom of the cylinder. The skein before sinking must be entirely covered with solution and yet it must possess enough buoyancy from the air within the yarn to keep the linen thread taut between the anchor and the hook (see Fig. 1). The average of at least four determinations of sinking time should be obtained for each concentration of wetting agent. An average deviation of 10-12% in sinking time may be expected (see 10.5).

8. Evaluation

8.1 The method of handling the data obtained by the technique described above is very important. The most useful plot where a complete curve is desired is

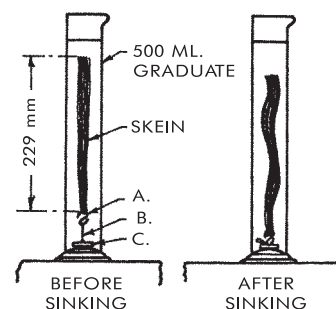

Fig. 1—Position of skein before and after sinking.

one made on log-log graph paper (Keuffel & Esser Co. or Eugene Dietzgen Co., both in New York) with logarithmic coordinates along both axes but reading directly in antilogarithms. Values of concentrations of wetting agent are shown on the horizontal scale, or X-axis, the value on the left being 0.1 g and the value on the right 10 g/L. In like manner, sinking times in seconds are shown on the vertical scale, or Y-axis, the value on the bottom being 1 or 10 s and the value at the top being 100 s. A smooth curve is drawn through the points. For most products this curve will be a straight line (see Fig. 2).

8.2 When sinking curves for two products have the same slopes for a 3.0 g hook, it has been found that they have the same slopes for any weight of hook by the method of testing described here, and they even have quite closely the same slopes for any other method of testing in which cotton is employed. Under such conditions it is then logical to assume that solutions that cause wetting in equal times for the same lot of cotton under similar conditions are equivalent. Comparisons of relative costs of wetting can then be made as illustrated in Table I, where the cost for 378.5 L of wetting agent is calculated from the following formula:

8.3 Cost for 378.5 L of solution at wetting conc. = $0.835 \times (\text{wetting conc. in g/L} \times (\text{cost per g}))$.

8.4 When two products have markedly different slopes for plots representing the relationship between sinking times and concentrations on log-log graph paper, great care must be exercised in interpreting the wetting data.

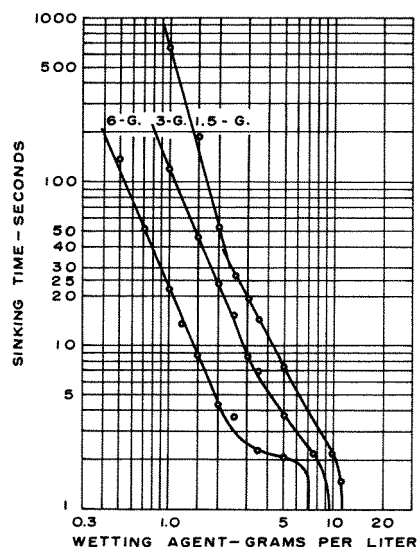

Fig. 2—Plot of results.
(See text under Evaluation.)

Table I—Comparison of Two Original Wetting Agents*

Standard		New Product
3.000 g	Wt. of hook	3.000 g
25C	Temperature	25C
20¢	Cost per lb	18¢
1.95	25 s wetting conc., g/L	2.44
100	Equivalent parts	125
32.5¢	Cost for 378.5 L of soln. at wetting conc.	36.7¢

*Medium: distilled water, neutral.

9. Precision and Bias

9.1 *Precision.* A *within-laboratory* test was conducted to establish the precision of the test method. Three testers, on three different days, performed four checks per level of surfactant. An average of the four checks was computed for each level of surfactant. Table II indicates the average, and the standard deviation, from the data of the three testers.

9.1.1 The coefficient of variation is being used to determine the bias of this method. The data used was generated from the *within-laboratory* results of three testers. Table III indicates the percentage per level of surfactant.

9.2 *Bias.* Wetting agents can be defined only in terms of a test method.

Table II—Sinking Time Average and Standard Deviation

Surfactant Level	Sinking Time	
	Avg. of 3 Testers	S.D. of 3 Testers
0.25 g/L	120.00 s	0 s
0.35 g/L	120.00 s	0 s
0.50 g/L	77.00 s	13.18 s
0.75 g/L	32.75 s	3.70 s
1.25 g/L	14.42 s	1.70 s
1.75 g/L	8.58 s	0.80 s
2.50 g/L	4.75 s	0.50 s
3.75 g/L	3.10 s	0.14 s
5.00 g/L	2.00 s	0 s

Table III—Coefficient of Variation at Different Surfactant Levels

Surfactant Level	CV %
0.25 g/L	0
0.35 g/L	0
0.50 g/L	17
0.75 g/L	11
1.25 g/L	12
1.75 g/L	9
2.50 g/L	11
3.75 g/L	5
5.00 g/L	0

There is no independent method for determining the true value. As a means of estimating this property, the method has no known bias.

10. Notes

10.1 The hook of a standard weight and the attached anchor are prepared as follows: A piece of No. 10 B&S gauge copper wire about 6.51 cm long is bent into the form of a hook as illustrated by "A" in Fig. 3 and then the weight of the bent hook is adjusted to exactly 3.000 g. Nickel, silver and stainless steel wire are even more suitable than copper for this purpose because they are more corrosion resisting. The anchor, "C," is a flat, cylindrical, lead slug weighing over 40 g and having a diameter of 25 mm and a thickness of about 4.7 mm. In the center of the anchor is soldered a loop of wire to serve as a small ring, or eye, for attaching the anchor to the hook with a fine linen thread, "B," at a distance apart of 19 mm. If many products are to be tested, prepare at least two hooks and anchors.

10.2 In the comparison of wetting agents it has been found that a 3.0 g hook gives a concentration for 25 s wetting which is most often fairly close to the concentration employed in practice for original wetting in various mill processes. If now, however, the concentration of wetting agent found satisfactory for the particular work in the mill is much higher or much lower than the concentration obtained with the 3.0 g hook, then a hook of a different weight should be employed for making comparisons between products which are valid for the particular situation.

For comparisons at low concentrations a 6.0 g, or even a 9.0 g hook, is employed for a sinking time of 25 s. Only products with sinking curves of similar slopes show the same equivalent values for 0.5 g, 1.5 g, 3.0 g, 6.0 g, and 9.0 g hooks at any standard sinking time.

For comparisons at higher concentrations than those corresponding to a sinking time of 25 s for a 3.0 g hook, a 0.5 g or a 1.5 g hook may be employed. For quicker and even more reliable results of higher concentrations it is advantageous to employ an electronic timing device and standard sinking times of 10 s and 4 s. The procedure otherwise is exactly the same as with the 3 g hook at 25 s.

10.3 Available from Testfabrics Inc., P.O. Box 26, 415 Delaware St., W. Pittston PA 18643; tel: 570/603-0432; fax: 570/603-0433;

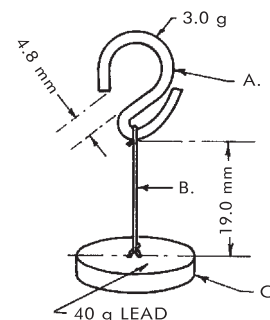

Fig. 3—Hook for use in test of wetting agents.

e-mail: testfabric@aol.com; and Textile Innovators Corp., div. of SDL Atlas L.L.C., P.O. Box 8, 101 Forest St., Windsor NC; tel: 252/794-9703; fax: 252/794-9704; e-mail: tic@sdlatlas.com. 40s/2 (30 tex) combed Peeler yarn with a lisle twist of 708.7-787.4 turns per meter and a balanced construction is suitable. All the tubes of greige cotton yarn used for making 5 g skeins for a given series of wetting tests must be from the same lot of cotton. To average out the slight differences still remaining between different tubes of the same lot and to increase the number of skeins which are closely alike in wetting properties for the series, it is urged that each skein be reeled simultaneously from 4-12 tubes of yarn. In the case of purchased skeins, the weights of the skein must be corrected individually to within 10 mg of 5 g.

10.4 The quality of the water used in the testing of wetting agents must be given careful consideration. The stock solution is best prepared with distilled water. When it is not known under what conditions the wetting agent is to be employed, distilled water may likewise be used for final solution. On the other hand, for the simulation of mill practice, the final solution for test—and even the first stock solutions—should be made up with water from the mill and with any ingredients which are necessary to duplicate exactly the chemical composition of the solutions as they will be used in practice. If this is done, the pH will take care of itself automatically, although the careful chemist will want to check the acidity or alkalinity of the final test solutions either colorimetrically or electrically.

For the purpose of uniformity, standard concentrations of acid and alkali are employed for routine tests made in other than neutral solution. It is recommended that tests be made at different temperatures in the presence of 5 or 10 g of conc. sulfuric acid (sp. gr. 1.84), 5 or 10 g of sodium carbonate and 5 or 10 g of caustic soda per liter of final solution, respectively.

10.5 The spread among readings for sinking time is considerably reduced by placing the cylinder for test on a vibrating surface. The bubbles are then more uniformly liberated, that is, occasional lingering is eliminated, and greater uniformity follows. It is to be observed that vibration produces lower average sinking concentrations for a given standard time and standard hook.

Fiber Analysis: Qualitative

Developed by AATCC Committee RA24. Adopted as Tentative 1955; revised 1958, 1962, 1963, 1972, 1976, 1998, 1999, 2000, 2001, 2002, 2004, 2005; editorially revised and reaffirmed 1973, 1990, 1995; editorially revised 1974, 1977, 1982 (new title), 1983, 1984, 1988; reaffirmed 1985. Related to ISO 3072.

1. Purpose and Scope

1.1 This test method describes physical, chemical and microscopical techniques for identifying textile fibers used commercially in the United States. Fibers may be examined in raw fiber form or taken from yarn or fabric.

1.2 These test methods may be used to identify generic fiber types as defined by the Textile Fibers Products Identification Act and subsequent rules and regulations of the Federal Trade Commission. Quantitative methods for determining percentages in blends of fibers are covered by AATCC Test Method 20A, Fiber Analysis: Quantitative.

1.3 The test methods apply to fibers which are shown below grouped by generic classifications:

Natural Fibers	Man-Made Fibers
Cellulose (Vegetable)	acetate
cotton	secondary
flax	triacetate
hemp	acrylic
jute	anidex
ramie	aramid
sisal (agave)	para aramid
manilla hemp (abaca)	meta aramid
	azlon
	glass
	lyocell
Keratin (Animal)	metallic
alpaca	modacrylic
camel	novoloid
cashmere	nylon
horse	6
llama	6,6
mohair	nytril
rabbit	olefin
silk	polyethylene
Bombyx (cultivated)	polypropylene
tussah (wild)	polyester
vicuna	rayon
wool	cuprammonium
yak	lyocell
	viscose
	rubber
	saran
	spandex
	vinal
Mineral	vinyon
asbestos	

2. Use and Limitations

2.1 This test method describes a number of procedures—microscopical examination, solubility in solvents, melting point, refractive index, and micro-Fourier Transform Infrared Spectroscopy—which should be used in combination to identify a fiber type. For identifying certain fibers some procedures will be found to be more effective than others.

2.2 For example, microscopical examination is particularly useful in characterizing the natural fibers. It must be used with caution on man-made fibers since they are frequently produced in a number of modifications which alter the longitudinal or cross-sectional appearance. In addition, man-made fibers may contain some or no delusterant or other additive particles. Filaments of a given type may vary in size or cross-sectional shape. Individual filaments may have two or more component sections of the same or different generic types.

2.3 Even natural fibers show a fairly wide variation in typical cross-section. No specific specimen will look exactly like the pictures published. A sufficient number of fibers should be examined to cover the range of appearance in any specimen.

2.4 Successful identification of fibers depends upon experience and familiarity with the fibers. The identification of an unknown fiber is best made by comparison with properly identified fibers used as reference standards. For this reason it is desirable to have available at least one representative fiber sample from each generic class of fibers, which can be used for comparative identification.

2.5 This test method provides means for identifying the generic classification of the common fiber types. In special cases, as when dealing with fibers not described in this method or attempting to distinguish between products of different suppliers of the same generic types, one must consult standard texts on fiber identification or technical bulletins issued by suppliers of man-made fibers. See references Section 13.

3. Terminology

3.1 For definitions of technical terms, refer to the *Glossary of AATCC Standard Terminology* in this TECHNICAL MANUAL.

4. Safety Precautions

NOTE: These safety precautions are

for information purposes only. The precautions are ancillary to the testing procedures and are not intended to be all inclusive. It is the user's responsibility to use safe and proper techniques in handling materials in this test method. Manufacturers MUST be consulted for specific details such as material safety data sheets and other manufacturer's recommendations. All OSHA standards and rules must also be consulted and followed.

4.1 Good laboratory practices should be followed. Wear safety glasses in all laboratory areas.

4.2 All chemicals should be handled with care.

4.3 In preparing, dispensing and handling the reagents outlined in Section 6, use chemical goggles or face shield, impervious gloves and an impervious apron. Concentrated acids should be handled only in an adequately ventilated laboratory hood. CAUTION: Always add acid to water.

4.4 All poisonous and flammable reagents should be mixed and handled only in an adequately ventilated laboratory hood. CAUTION: Acetone and ethyl alcohol are highly flammable and should be stored in the laboratory only in small containers away from heat, open flame and sparks.

4.5 An eyewash/safety shower should be located nearby and an organic vapor respirator should be readily available for emergency use.

4.6 Exposure to chemicals used in this procedure must be controlled at or below levels set by governmental authorities (e.g., Occupational Safety and Health Administration's [OSHA] permissible exposure limits [PEL] as found in 29 CFR 1910.1000 of January 1, 1989). In addition, the American Conference of Governmental Industrial Hygienists (ACGIH) Threshold Limit Values (TLVs) comprised of time weighted averages (TLV-TWA), short term exposure limits (TLV-STEL) and ceiling limits (TLV-C) are recommended as a general guide for air contaminant exposure which should be met (see 12.5).

5. Apparatus

5.1 Compound microscope with matched objectives and eye pieces to achieve magnifications of 100-500X and equipped with a polarizer and analyzer.

5.2 Glass slides and cover glasses.

5.3 Dissection needles.

5.4 Scissors (small) and tweezers (fine).

5.5 Cross-sectioning device of one type such as listed below.

5.5.1 Stainless steel plate, $2.54 \times 7.62 \times 0.0254$ cm ($1 \times 3 \times 0.01$ in.) drilled with 0.09 cm (0.04 in.) diameter holes. Soft copper magnet wire AWG #34, 0.016 cm (0.0063 in.) diameter.

5.5.2 Microtome, hand (see 12.1).

5.6 Razor blades, sharp, thin, single edge or double edge with holder.

5.7 Density gradient tube, glass approximately 2.5 cm (1 in.) in diameter and 45 cm (18 in.) long with a sealed bottom and a 24/40 standard taper joint glass cap closure at top to avoid moisture pickup or evaporation of solvents. Tiny glass spheres of calibrated density may be used as density standards (see 12.2).

5.8 Melting point apparatus consisting of a heated block, temperature measuring device such as a thermometer and means for controlling the rate of heating and viewing the specimen at low magnification. The instrument should have a range of 100-300°C or more, and an accuracy of ± 1 degree over the entire range (see 12.3).

5.9 Micro-FTIR Instrument.

6. Reagents and Materials

6.1 Mounting Reagents.

6.1.1 Mineral oil, U.S.P. or other immersion fluid (see 12.4).

6.1.2 Collodion, solution of nitrocellulose (4 g/100 mL) in 1:3 alcohol/ethyl ether.

6.2 Bleaching Reagent.

6.2.1 Hydrosulfite-caustic solution. Dissolve 2 g sodium hydrosulfite and 2 g sodium hydroxide in 100 mL of water.

6.3 Staining Reagents.

6.3.1 Zinc chloro-iodide reagent. Dissolve 20 g of zinc chloride in 10 mL of water. Add 2.1 g of potassium iodide and 0.1 g of iodine dissolved in 5 mL of water. Add a leaf of iodine.

6.3.2 Acid phloroglucinol reagent. Dissolve 2 g of phloroglucinol in 100 mL of water. Use with equal volume of concentrated hydrochloric acid.

6.4 Refractive Index Immersion Liquids.

6.4.1 Hexadecane (cetane) C. P. Grade, RI = 1.434.

6.4.2 Alpha chloronaphthalene, RI = 1.633. Poisonous. Avoid inhaling vapors.

6.4.3 Blends of the above. Assume that the refractive index varies linearly by volume of ingredients. For example, to make a liquid of RI = 1.550 mix 42 parts by volume of hexadecane with 58 parts by volume of alpha chloronaphthalene (see 12.4).

6.5 Fiber Solvents.

6.5.1 Acetic acid, glacial. Corrosive. Do not get in eyes or on skin.

6.5.2 Acetone, reagent grade. (Caution: highly flammable).

6.5.3 Sodium hypochlorite solution, 5%. Home laundry bleach is satisfactory.

6.5.4 Hydrochloric acid, concentrated reagent, 20%. Dilute 50 mL of concentrated hydrochloric acid, 38%, to 95 mL with distilled water.

6.5.5 Formic acid, 85%. Corrosive. Do not get in eyes or on skin.

6.5.6 1,4-Dioxane.

6.5.7 *m*-Xylene.

6.5.8 Cyclohexanone.

6.5.9 Dimethylformamide. (Caution: if spilled on skin, wash off immediately.)

6.5.10 Sulfuric acid solution, $59.5 \pm 0.25\%$ by weight, density 1.4929 ± 0.0027 g per mL at 20°C. Weigh into a beaker 59.5 g of concentrated sulfuric acid (sp gr 1.84). Weigh into a 250 mL Pyrex Erlenmeyer flask 40.5 g of distilled water. Cautiously add *the acid to the water* swirling and cooling in ice water or under a tap. *Wear goggles!* The solution becomes very hot and may boil and spatter if not cooled during mixing. After the solution has cooled to 20°C (68°F) adjust the density to a value between 1.4902 and 1.4956 g per mL.

6.5.11 Sulfuric acid solution, ($70 \pm 1\%$ by weight, density 1.6105 ± 0.0116 g per mL at 20°C). Weigh 70 g of concentrated sulfuric acid (sp gr 1.84) and 30 g of water and mix with the same precautions as in 6.5.10. After the solution has cooled to 20°C (68°F) adjust the density to a value between 1.5989 and 1.6221 g per mL.

6.5.12 *m*-Cresol, reagent grade. Poisonous. Use in ventilated hood.

6.5.13 Hydrofluoric acid, 49% reagent grade. Very dangerous. Use goggles and hood under suction. Do not inhale vapors or allow to contact skin.

7. Sampling

7.1 To obtain a representative sample for identification it is necessary to consider the following:

7.1.1 If the sample is loose fiber or yarn, it may contain one fiber only or it may be an intimate blend of two or more fibers.

7.1.2 A yarn sample may be a ply or wrapped core blend of two or more yarns. These yarns in turn may be the same or different and may themselves contain a blend of fibers.

7.1.3 Woven and knitted fabrics may be constructed of the same or different yarns in various combinations. The yarn may contain one or more fiber types.

7.1.4 Different fiber types may be dyed to the same color. Contrarywise, the same fiber type may appear in different colors in the finished article by mixing stock dyed or yarn dyed materials or using fibers with modified dyeing characteristics.

7.1.5 It is essential that the specimens selected represent the entire sample of

raw fiber, yarn or fabric under examination.

8. Specimen Preparation

8.1 In many cases the identity of an unknown fiber can be established without pretreatment.

8.2 When the presence of starch, wax, oil or other coating obscures the appearance of the fiber, try heating in warm to hot distilled water to remove the foreign matter. If this fails, try extracting with organic solvents, 0.5% hydrochloric acid or 0.5% sodium hydroxide. Some fibers such as nylon are damaged by acid and some such as azlon, silk and wool, are damaged by caustic treatment (see 9.7).

8.3 To separate vegetable fiber bundles, treat with 0.5% sodium hydroxide solution, rinse well with water and dry.

8.4 To strip dye from colored fibers, especially the cellulosic fibers, heat for 30 min at 50°C with hydrosulfite caustic solution (see 6.2.1).

9. Procedure

9.1 The identification of fibers is usually carried out by subjecting specimens to a variety of selected tests until enough information is obtained to make a satisfactory judgment as to the generic class or specific type. The selection of tests and order in which they are performed can change depending on the knowledge already available and results of the preliminary tests.

9.2 Visual and Microscopical Examination.

9.2.1 Examine the sample of material submitted for identification. Note form (loose fibers, yarn, fabric, etc.), color, fiber length and fineness, uniformity of appearance and probable end-use. If the sample is a fabric, separate out yarns by unraveling or cutting. If the fabric is woven, separate warp and filling yarns. If yarns differ in color, luster, size or other apparent ways, make a physical separation of these yarns for separate identification.

9.2.2 The fibers may be identified using either light or scanning electron microscopy. If using transmitted light microscopy, place a small quantity of the fibers on a glass slide, tease fibers apart, mount with a drop of mineral oil or other immersion fluid, cover with a cover slip and examine under the microscope.

9.2.3 Observe the fiber characteristics as seen in traverse section and classify into four general classes.

9.2.4 Fibers with surface scales. These are the animal hair fibers listed in Purpose and Scope (see 1.3). All of the keratin fibers listed except silk are included in this group. Continue detailed microscopical examination including cross-section

examination (see 9.3). Compare with the characteristics in Table I, photographs in the appendix of this method, and known specimens of hair fibers. Additional confirmation of this class may be made by burning test (see 9.5); density (see 9.6); and solubility (see 9.7).

9.2.5 Fibers with Cross Markings. These are the vegetable fibers other than cotton listed in 1.3. Continue detailed microscopical examination including cross-section examination (see 9.3). Compare with characteristics as given in Table II, photographs and known specimens of vegetable fibers. To distinguish flax and ramie from hemp, observe the direction of rotation on drying (see 9.8). If the fibers are light in color, stain with zinc chloro-iodide reagent and with acid phloroglucinol as directed in 9.9. Additional confirmation of this class may be made by tests described in 9.4, 9.5, 9.6 and 9.7.

9.2.6 Convoluted Fibers. This class includes cotton and tussah silk. The two are easily distinguished by cross-section (see 9.2), burning test (see 9.5) and solubility (see 9.7) or micro-FTIR (see Appendix II). If fibers are light in color, they may be distinguished by staining with zinc chloro-iodide reagent (see 9.9).

9.2.7 Other Fibers. This class includes all of the man-made fibers, Bombyx silk and asbestos. The latter two can be identified by microscopical appearance including cross-section (see 9.3). Burning tests (see 9.5) and solubility tests (see 9.7) are especially significant for asbestos and are useful in confirming the presence of silk.

The man-made fibers are best identified by micro-FTIR, solubility, melting point, refractive indices and other optical characteristics and density: properties which relate to chemical nature rather than physical shape. Cross-sections may vary and staining tests can be misleading since modifications of a generic type may dye differently. Used with discrimination and in combination with other tests, cross-sections and dye tests may sometimes be helpful in narrowing down the number of possibilities. Metallic fibers have a distinctive shiny appearance, but a shiny residue may not indicate a metallic fiber. Using a transmitted light microscope at 5x, 10x and 20x magnification powers will not reveal diffraction, interference and gloss effects that can deceptively appear to be metallic in nature. Chemical (colorimetric) and/or instrumental (Atomic Absorption Spectrophotometric) analyses should be performed to confirm their presence.

9.3 Microscopical Cross-Section Examination.

9.3.1 Obtain a parallel bundle of fibers or yarn. Thread a loop of copper wire through one hole in the stainless steel plate. Catch the bundle or yarn in the loop and pull it through the hole. Use suf-

Table I—Characteristics of Fibers with Scales on Surface
Note: The characteristic designated by a capital letter X in this table is that which is especially significant.

Microscopical Appearance	Alpaca	Camel	Cashmere ^{d,e}	Horse	Llama	Mohair	Vicuna	Wool ^c	Yak
Longitudinal:									
Epidermis:									
Pronounced	—	—	—	—	—	—	—	X	—
Faint	x	x	X	x	x	X	x	—	x
Coronal ^a	—	x	x	X	—	—	x	x	x
Imbricate ^b	x	x	—	—	x	x	—	x	x
Smooth edge	—	x	x	x	—	x	x	x	—
Serrated edge	X	—	—	x	X	—	—	—	x
Medulla:									
Occurrence:									
Usually present	x	—	—	x	X	—	—	—	—
Seldom present	—	x	X	—	—	x	x	x	—
Never present	—	—	—	—	—	—	—	—	x
Type:									
Fragmental	x	x	—	—	x	—	x	x	—
Interrupted	x	—	—	—	x	x	x	x	—
Continuous	x	—	—	x	x	x	—	—	—
Size (ratio to fiber diameter):									
Under ¼	—	—	—	—	—	x	x	x	—
¼ to ½	x	—	—	x	x	x	—	x	—
Over ½	—	—	—	X	—	—	—	—	—
Pigment:									
Diffuse	—	—	x	—	—	—	—	—	—
Streaky	x	X	x	—	x	—	x	—	x
Granular	—	x	—	x	—	—	—	—	x
None	—	—	—	—	—	X	—	X	—
Cross-Section:									
Contour:									
Round to oval	—	x	x	x	—	x	x	x	x
Oval to elongated	x	—	—	—	x	—	—	x	—
Kidney	x	—	—	—	x	—	—	—	—
Medulla contour:									
Round to oval	—	—	—	x	—	x	x	x	—
Oval to elongated	X	—	—	—	X	—	—	—	—
Kidney to dumbbell	X	—	—	—	X	—	—	—	—
Pigment distribution:									
Uniform	x	X	—	—	x	—	x	—	x
Centric	—	—	X	—	—	—	—	—	—
Eccentric	—	—	—	X	—	—	—	—	—
Fineness (in µm)									
Average	26 to 28	18	15 to 18.5	—	26 to 28	—	13 to 14	—	18 to 22
Range	10 to 50	9 to 40	5 to 30	—	10 to 40	10 to 90	6 to 25	10 to 70	8 to 50
Number of scales per 100 µm									
	—	—	6 to 7	—	—	Under 5.5	—	Over 5.5	Over 7

^a Coronal means crownlike, and refers to scales in which the visible scale edge completely encircles the fiber.

^b Imbricate means overlapping, and refers to scales in which the visible scale edges overlap like shingles on a roof and cover only a part of the fiber circumference.

^c The term wool is used here to represent clothing wool and not carpet wool.

^d The longitudinal/epidermal appearance of cashmere fiber while generally fainter than that of sheep's wool is not as faint as some specialty fibers such as camel and alpaca.

^e The average diameter for cashmere fibers was broadened in 2000 based on a review of published research concerning Asian *capra hircus*.

Table II—Appearance of Fibers with Cross Markings or Swellings

Longitudinal Section:	Flax	Hemp	Ramie
Ratio, lumen of fiber diameter	under ⅓	usually over ⅓	over ⅓
Cell ends	pointed	blunt or forked	blunt
Cross-Section:			
Contour	sharp polygon	rounded polygon	elongated polygon
Lumen	round or oval	irregular	irregular

ficient fibers to pack the hole full. If necessary, use some extra, readily identifiable other fiber to fill up the hole.

9.3.2 With a sharp razor blade make a smooth cut on both sides of the plate.

9.3.3 Examine the section in air, or covered by a mounting fluid like mineral oil under a cover slip. Use transmitted light and useful magnification of 200-500X. Compare with photographs in Ap-

pendix or cross-sections of known fibers.

9.3.4 If the Hardy type microtome is used, follow instructions with the instrument. Insert a bundle of fibers or yarn into the slot. Slide the tongue into the slot to compress the bundle. Adjust the quantity of fibers for a tight package. Cut off both sides. Apply a drop of collodion to one cut face, wait until it shows through on the other side and then apply a drop to the other side. Let dry thoroughly. Slice off excess collodion and fiber on both sides of the plate with a sharp razor blade.

9.3.5 Attach the auxiliary plunger, and with the screw advance the embedded tuft through the slot until it protrudes 20-40 μm above the plate. Add a drop of collodion and let dry about 5 min or until firm. Slice off collodion and embedded fiber section with a sharp razor blade held at about 45° angle with the slot. Cut with a single stroke.

9.3.6 Remove the section, transfer to a glass slide, mount with a drop of mineral oil or other immersion liquid, add a cover slip and examine. Continue to cut sections as described in 9.3.5 until good clear cross-sections are obtained. Examine and compare to known cross-sections.

9.4 Refractive Index.

9.4.1 Place a small sample of the fiber on a glass slide. Immerse in a drop of a chloronaphthalene and cetane mixture (or equivalent) of refractive index 1.55.

9.4.2 Insert the polarizer into the substage of the microscope to provide light polarized in the 6-12 o'clock direction. Align the long dimension of a fiber in the same direction. Close the diaphragm of the substage condenser so as to provide axial illumination.

9.4.3 Focus carefully on the outlines of the fiber. With the fine adjustment, raise the focus to just above the top of the fiber. If the fiber is roughly a cylinder, it will act like a lens. If the refractive index of the fiber is *higher* than the immersion liquid, the fiber will act like a positive lens. A bright line of light will move into the middle of the fiber as the focus is raised. If the refractive index of the fiber is *lower* than the immersion liquid, the light will flare out as the focus is raised and the middle of the fiber will become darker. Repeat until certain of the direction.

9.4.4 The test can be seen best with round fibers. On flat ribbons it may be easier to see movement of a bright line—the Becke line—at the outlines of the fiber. Movement is in the same direction, toward the medium of higher refractive index as the focus is raised.

9.4.5 Rotate the specimen 90° and repeat the test.

9.4.6 Rotate the specimen 45°. Insert the analyzer in the body tube or eyepiece to provide crossed polars. Observe if the

fiber appears very bright (strong birefringence), dim (weak birefringence) or dark (no birefringence).

9.4.7 Refer to Table IV for refractive index of fibers in the long and cross direction and an estimate of birefringence. Consider that the retardation depends on the thickness of the fiber specimen as well as the extent of drawing of a given specimen. Compare with known fibers of similar diameter for birefringence.

9.4.8 Select other immersion liquids and repeat 9.4.1 through 9.4.5. As the refractive index of the liquid approaches that of the fiber, the outlines of the fiber become less distinct. Match the liquid to the fiber within 0.01 refractive index.

9.5 Burning Test.

9.5.1 Take a small tuft of fibers (held in tweezers) and place close to the side of a small flame. Note if the fibers melt or shrink from the flame.

9.5.2 Move the fibers into the flame. Note whether the fibers will burn when held in the flame. Remove from the flame very slowly and carefully. Note whether the fibers continue to burn outside of the flame. Make sure that the fiber was ignited before making this latter observation.

9.5.3 Blow out the flame, if still burning, and smell the smoke. Note the odor and examine the color and nature of any ash residue.

9.5.4 Compare the behavior observed with that listed in Table III and that of known reference fibers. Flame retardant modifications of some fibers—cotton, rayon, acetate and modacrylic, for example—are available. Burning is retarded; odor on burning and ash may be changed. Colored fibers—especially those colored by pigments—will retain color in the colored residue.

9.5.5 Odors of some burning fibers are quite characteristic. The animal fibers and man-made protein fibers (azlon) have the odor of burning hair or feathers. The vegetable fibers and regenerated cellulose (rayon) smell like burning paper. The smell of burning rubber is a familiar odor. Other man-made fibers—such as acrylic, nylon and spandex—have characteristic odors which can be recognized with experience.

9.6 Density.

9.6.1 Prepare a density gradient column as follows. Clamp the density gradient glass tube in a firm vertical stand. Pour into the tube 25 mL of tetrachloroethylene. Now prepare mixtures of xylene and tetrachloroethylene by volume in descending order of percent tetrachloroethylene: 90/10, 80/20, 70/30, 60/40, 50/50, 40/60, 30/70, 20/80 and 10/90. Pour 25 mL of each in order carefully down the side of the gradient tube. Finally, put 25 mL of xylene on top.

Table III—Reaction to Flame

	Melts Near Flame	Shrinks From Flame	Burns in Flame	Continues to Burn	Appearance of Ash
Natural Fibers					
silk	yes	yes	yes	slowly	soft black bead
wool	yes	yes	yes	slowly	irregular black
cellulose	no	no	yes	yes	light greyish
asbestos	no	no	no	no	may blacken
Man-Made Fibers					
acrylic	yes	yes	yes	yes	hard black
acetate					irregular
azlon					shaped
nytril					bead
polyester	yes	yes	yes	yes	hard black
					round bead
nylon	yes	yes	yes	yes	hard grey
					round bead
olefin	yes	yes	yes	yes	hard tan bead
vinal					
modacrylic	yes	yes	yes	no	hard black
saran					irregular bead
vinyon					
metallic	yes	yes	no	no	metal bead
glass	yes	slowly	no	no	hard clear
					bead
rubber	yes	yes	yes	no	irregular mass
spandex	yes	no	yes	yes	fluffy black
					or grey
anidex	yes	no	yes	yes	brittle black
					irregular bead
rayon	no	no	yes	yes	none
aramid	no	yes	yes	no	hard black
					bead
novoloid	no	no	brief	no	carbon

Table IV—Physical Properties of Fibers

	Refractive Index		Birefringence	Density g/cc	Melting Point Degree C
	Long	Cross			
Natural Fibers					
asbestos (chrysotile)	1.50-1.55	1.49	strong	2.1-2.8	over 350
cellulose	1.58-1.60	1.52-1.53	strong	1.51	none
silk	1.59	1.54	strong	1.32-1.34	none
wool and other hair	1.55-1.56	1.55	weak	1.15-1.30	none
Man-Made Fibers					
acetate, secondary	1.47-1.48	1.47-1.48	weak	1.32	260
acetate, tri.	1.47-1.48	1.47-1.48	weak	1.30	288
acrylic	1.50-1.52	1.50-1.52	weak, negative	1.12-1.19	none
anidex		opaque	—	1.22	softens at 190 chars at 400
aramid	—	—	strong	1.38	none
azlon	1.53-1.54	1.53-1.54	none	1.30	850
glass	1.55	1.55	none	2.4-2.6	over 300
metallic		opaque	—	varies	188* or 120
modacrylic	1.54	1.53	weak	1.30 or 1.36	218
novoloid		1.5-1.7	none	1.25	250-260 or 282
nylon	1.57	1.51	strong	1.12-1.15	135
nylon 6,6	1.58	1.52	strong	1.12-1.15	170
nytril	1.48	1.48	nil	1.20	none
polyester	1.71-1.73 or 1.63	1.53-1.54	intense	1.38 or 1.23	168
polyethylene	1.56	1.51	strong	0.90-0.92	230
polypropylene	1.56	1.51	strong	0.90-0.92	—
rayon	1.54-1.56	1.51-1.53	strong	1.51	230 or 400
rubber		opaque	—	0.96-1.06	
saran	1.61	1.61	weak, negative	1.70	
spandex		opaque	—	1.20-1.21	
vinal	1.55	1.52	strong	1.26-1.30	
vinylon	1.53-1.54	1.53	weak, negative	1.34-1.37	

*Not sharp. Sticking point is 176°C.

9.6.2 Take short fragments of dyed reference fibers and tie in a knot snipping off loose ends. Boil for about 2 min in xylene solvent to remove moisture and air. Place in the column. After about a half hour they should come to rest at the level representing their density. Calibrated glass spheres may be used to determine the actual density at various levels.

9.6.3 Prepare the unknown fiber in like manner, place in the gradient column and note at what level it floats. Densities of fibers are listed in Table IV.

9.7 Solubility Test.

9.7.1 For tests at room temperature (20°C) place a small sample of the fibers in a watch crystal, test tube or 50 mL beaker and cover with the test solvent (see Table V). Use about 1 mL of solvent per 10 mg of fiber.

9.7.2 If the test is conducted at the boiling point of the solvent, first bring the solvent to a boil in a beaker on an electric hot plate in a ventilated hood. Adjust the hot plate temperature to maintain slow boiling and keep watch so that the solvent does not boil dry. Drop fiber sample into the boiling solvent.

9.7.3 If the test is conducted at some intermediate temperature, heat a beaker

of water on a hot plate and adjust the temperature with a thermometer. Place the fiber sample in the test solvent in a test tube and immerse in the heated water bath.

9.7.4 Note if the fiber dissolves completely, softens to a plastic mass or remains insoluble. Compare with data on fiber solubility in Table V.

9.7.5 Solubility can also be used as a test to determine the presence of a metal component in a fiber. On dissolving in meta-cresol a shiny residue is evidence of a metal component.

9.8 Drying Twist Test.

9.8.1 Separate out a few parallel fibers. Dip in water and squeeze off excess. Tap the end of the bundle to make separate fibers flare out. Hold over a hot plate in warm air to dry the fibers. Hold the fibers so that the free ends point toward the observer. Note the direction of twist as the fibers dry. Flax and ramie twist in a clockwise direction; hemp and jute twist in a counter clockwise direction.

9.9 Stain Tests.

9.9.1 Place a few fibers on a microscopical slide. Apply a drop of zinc chloro-iodide reagent and cover with a cover slip taking care to avoid bubbles.

Examine the fibers for staining. Hemp, ramie and cotton stain violet; flax stains brownish violet; jute stains brown. Many other fibers stain shades of yellow brown including silk.

9.9.2 Warm a few fresh fibers on a microscopical slide with a drop of acid phlorogucinol reagent. Woody fibers such as unbleached jute stain a deep magenta because of the presence of lignin.

9.10 Melting Point.

9.10.1 Fisher-Johns Apparatus.

9.10.2 Place a few fibers on the clean heating block. Cover with a cover slip. Turn the heat on and set the heating rate dial on 90 for fast heating. Observe the thermometer and the sample. When the temperature reaches 100°C, reduce the rate of heating. (If previous tests already indicate the fiber, the rate can be set at about 10°C per min until 10-20°C below the expected melting point.) Near the melting point the rate should be reduced to about 2°C per min.

9.10.3 Observe the fibers for evidence of softening. At the melting point, liquid begins to form which wets the cover slip. Fibers eventually merge and form a liquid mass. As the test is in progress it is sometimes helpful to press gently on the cover slip with tweezers to see if the fibers flatten under pressure. If this melting point is passed at a high heating rate, repeat the test with a fresh sample.

9.10.4 Compare the melting point found with those listed in Table IV.

9.10.5 Kofler Hot Stage.

9.10.6 Place a few fibers on one of the small glass slides provided and cover with a cover slip. Place the slide on the stage of the microscope with the fibers over the central hole of the stage. Put the baffle and cover plate in place.

9.10.7 Insert the polarizing accessories in the optical path of the microscope to provide crossed polars. The fibers should be visible if aligned diagonally to the direction of polarization. If fibers are not visible under these lighting conditions, remove the polarizing accessories and observe in ordinary transmitted light.

9.10.8 Set a high heating rate with the voltage regulator until the temperature reaches 100°C. Reduce the rate as the expected melting point is approached as directed in 9.10.2.

9.10.9 Observe the fibers. As melting takes place there is a decrease in birefringence; the fibers become dark. Read as melting point the temperature at which the fibers become completely dark. If crossed polars are not used, observe melting as described in 9.10.2.

9.10.10 Compare the melting point found with those listed in Table IV.

9.11 Micro-FTIR.

9.11.1 Compare FTIR spectra with FTIR spectra in Appendix II or other library sources (see Appendix II—Figs. 1-9).

Table V—Solubility of Fibers

	acetic acid	acetone	sodium hypochlorite	hydrochloric acid	formic acid	1,4 dioxane	m-xylene	cyclohexanone	dimethyl formamide	sulfuric acid	sulfuric acid	m-cresol	hydrofluoric acid
Concentration (%)	100	100	5	20	85	100	100	100	100	59.5	70	100	50
Temperature (°C)	20	20	20	20	20	101	139	156	90	20	38	139	50
Time (minutes)	5	5	20	10	5	5	5	5	10	20	20	5	20
acetate	S	S	I	I	S	S	I	S	S	S	S	S	I
acrylic	I	I	I	I	I	I	I	I	S	I	I	P	I
anidex	I	I	I	I	I	I	I	I	I	I	I	I	I
aramid	I	I	I	I	I	I	I	I	I	I	I	I	I
azlon	I	I	S	I	I	I	I	I	I	I	I	I	I
cotton & flax	I	I	I	I	I	I	I	I	I	I	S	I	I
glass	I	I	I	I	I	I	I	I	I	I	I	I	S
modacrylic	I	SE	I	I	I	SP	I	S	SP*	I	I	P	I
novoloid	I	I	I	I	I	I	I	I	I	I	I	I	†
nylon	I	I	I	S	S	I	I	I	N	S	S	S	I
nytril	I	I	I	I	I	I	I	S	S	I	I	SP	I
olefin	I	I	I	I	I	I	S	S	I	I	I	I	I
polyester	I	I	I	I	I	I	I	I	I	I	I	S	I
rayon	I	I	I	I	I	I	I	I	I	S	S	I	I
saran	I	I	I	I	I	S	S	S	S	I	I	I	I
silk	I	I	S	I	I	I	I	I	I	S	S	I	I
spandex	I	I	I	I	I	I	I	I	S	SP	SP	SP	I
teflon	I	I	I	I	I	I	I	I	I	I	I	I	I
vinal	I	I	I	S	S	I	I	I	I	S	S	I	I
vinyon	I	S	I	I	I	S	S	S	S	I	I	S	I
wool	I	I	S	I	I	I	I	I	I	I	I	I	I

S = Soluble
 I = Insoluble
 P = Forms plastic mass
 SP = Soluble or forms plastic mass
 SE = Soluble except for one modacrylic fiber characterized by low flammability and liquid inclusions visible in cross-section.
 N = Nylon 6 is soluble, nylon 6,6 is insoluble.
 * = Soluble at 20C without plastic mass.
 † = Novoloid turns red

10. Report

10.1 Report the fiber type and, if more than one type is present, where each is located. For example, the report could be “woven fabric with nylon 6,6 warp and cotton/rayon filling.”

11. Precision and Bias

11.1 A precision and bias statement is not applicable because data are not generated by this method.

12. Notes

12.1 Available from SDL Atlas L.L.C., 1813A Associate Lane, Charlotte NC 28217; tel: 704/329-0911; fax: 704/329-0914; e-mail: info@sdlatlas.com.

12.2 Available from Techne Inc., 743 Alexander Rd., Princeton NJ 08540; tel: 609/452-9275.

12.3 Various commercial units are available. One widely used by textile laboratories is available from Fisher Scientific Co. at its various locations. A unit to fit the microscope is the Kofler micro hot stage supplied by A. H. Thomas Co., Vine and Third St., Philadelphia PA 19105.

12.4 Immersion liquids for refractive index measurements already blended and standardized are sold by RP Cargille Laboratories, Cedar Grove NJ 07009; tel: 973/239-6633.

12.5 Available from Publications Office, ACGIH, Kemper Woods Center, 1330 Kemper Meadow Dr., Cincinnati OH 45240; tel: 513/742-2020.

13. References

13.1 The Textile Institute, *Identification of Textile Materials*, Sixth Edition, C. Tinling & Co., London, 1970. Available through the Textile Institute, 10 Blackfriars St., Manchester M3 5DR, England. This is the best general reference in English. It is revised periodically.

13.2 Federal Trade Commission, “Rules and Regulations Under the Textile Fiber Products Identification Act,” as amended 1969, Washington, DC 20580, www.ftc.gov.

13.3 Heyn, A. N. J., *Fiber Microscopy, A Text Book and Laboratory Manual*, Interscience, New York, 1954. Old, but good techniques and illustrations.

13.4 Wildman A. B., *The Microscopy of Animal Textile Fibers*, Wool Industries Research Association, Torrion, Leeds, England, 1954.

13.5 Appleyard, H. M., *Guide to the Identifi-*

fication of Animal Fibers, same publisher as 13.4, 1960. Both contain excellent descriptions and photomicrographs.

13.6 Man-Made Fiber Producers Association, *Man-Made Fiber Fact Book*, New York, 1970. Revised annually. List of current fibers made in United States.

13.7 Man-Made Textiles, *Index to Man-Made Fibers of the World*, Third Edition, Harlequin Press, Manchester 2, England, 1967. Lists about 2,000 man-made fibers by trademark names and their suppliers.

13.8 Linton, G. E., *Natural and Man-Made Textile Fibers*, Duell, Sloan and Pearce. New York, 1966. History and technology, especially of natural fibers.

13.9 Potter, D. M. and Corbman, B. P., *Textiles: Fibers to Fabric*, Fourth Edition, McGraw-Hill, New York, 1967. A textbook with section on fiber identification.

13.10 Chamot, E. M., and Mason, C. W., *Chemical Microscopy, Vol. I on Physical Methods*, Third Edition, John Wiley & Sons, New York, 1950. A classical textbook with various references to fibers.

13.11 IWTO Draft Test Method 58-97, “Quantitative Analysis of Blends of Wool with Specialty Fibers by Scanning Electron Microscope.” Describes method for distinguishing between specialty animal fibers and wool and provides numerous references.

Appendix I

Photomicrographs of Common Textile Fibers

Cross-Section 500X

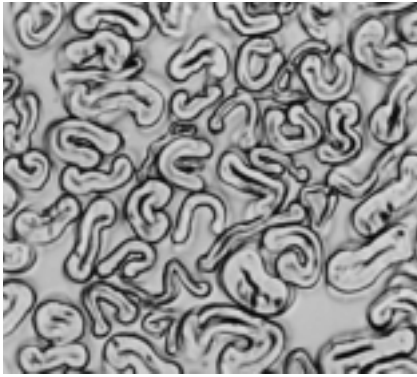

Cross-Section 500X

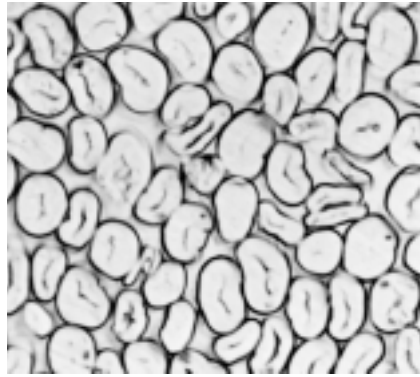

Cross-Section 500X

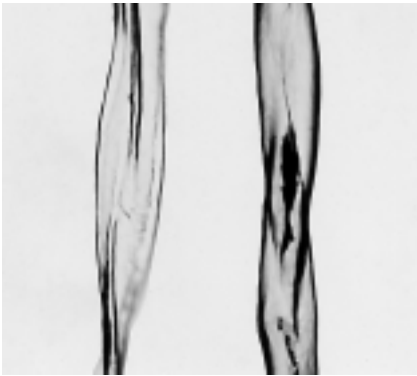
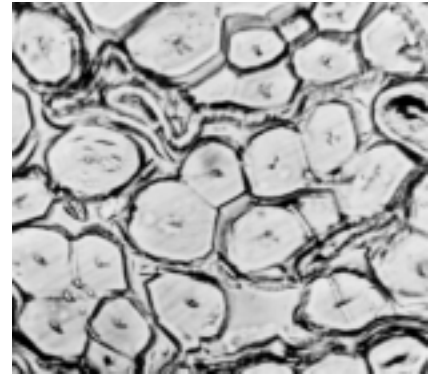

Longitudinal View 500X

Fig. 1—Cotton, not mercerized.



Longitudinal View 500X

Fig. 2—Cotton, mercerized.

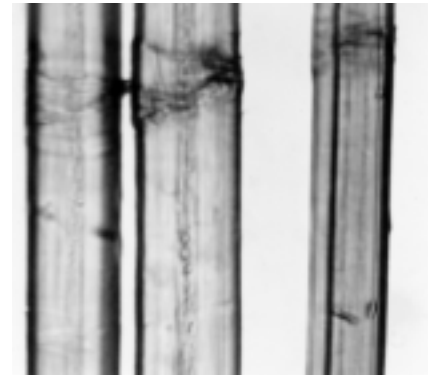

Longitudinal View 500X

Fig. 3—Flax.

Cross-Section 500X

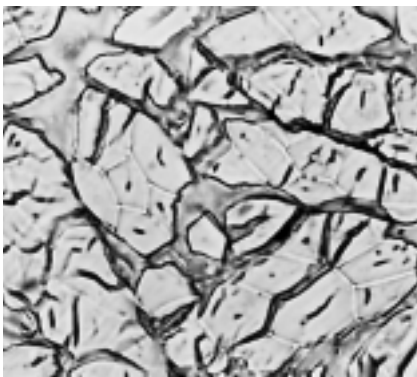

Cross-Section 500X

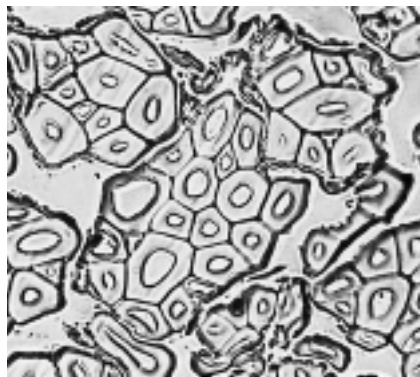

Cross-Section 500X

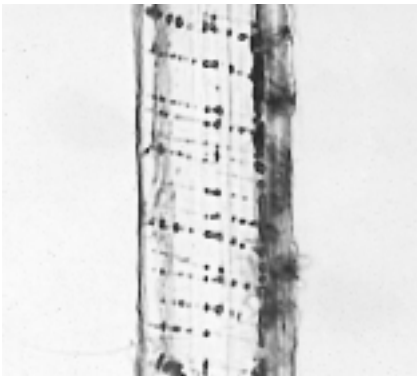
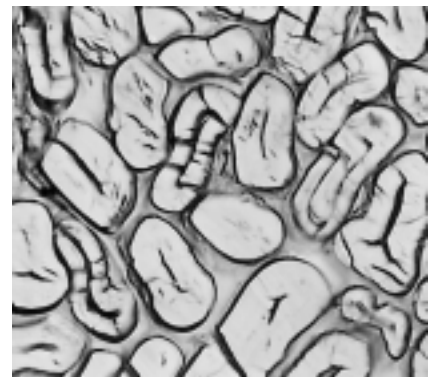

Longitudinal View 500X

Fig. 4—Hemp.



Longitudinal View 500X

Fig. 5—Jute.



Longitudinal View 500X

Fig. 6—Ramie.

Cross-Section 500X

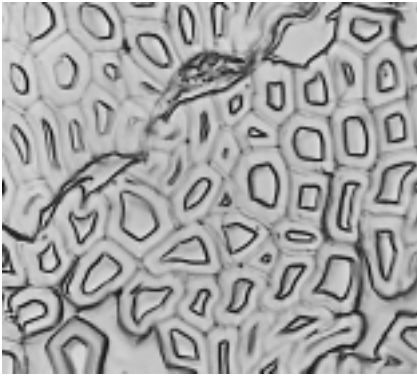

Cross-Section 500X

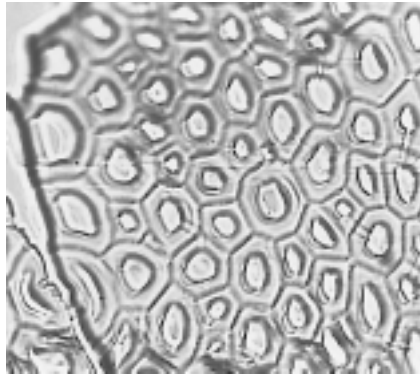

Cross-Section 500X

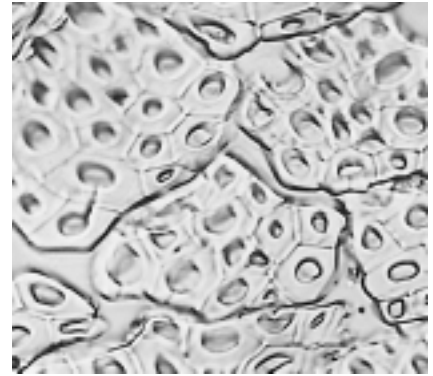

Longitudinal View 500X

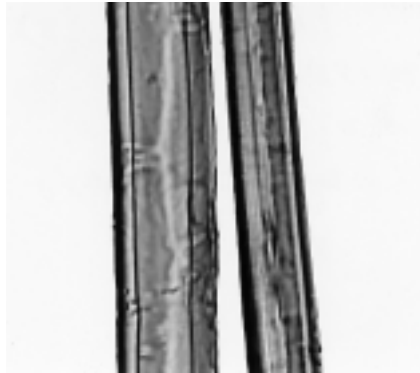

Longitudinal View 500X



Longitudinal View 500X

Fig. 7—Sisal.

Fig. 8—Abaca.

Fig. 9—Kenaf.

Cross-Section 500X

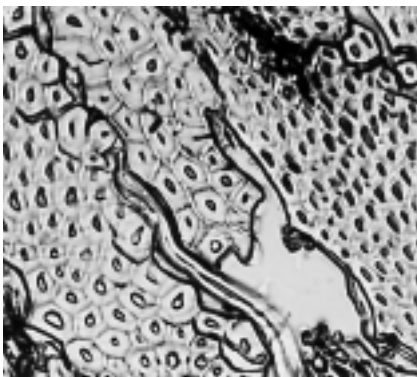

Cross-Section 500X

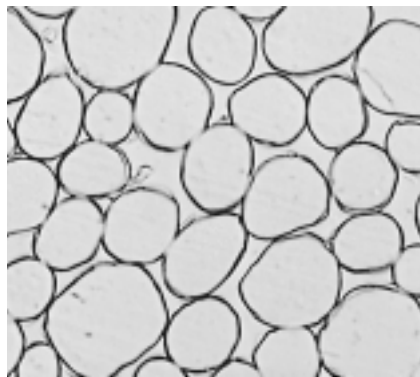

Cross-Section 500X

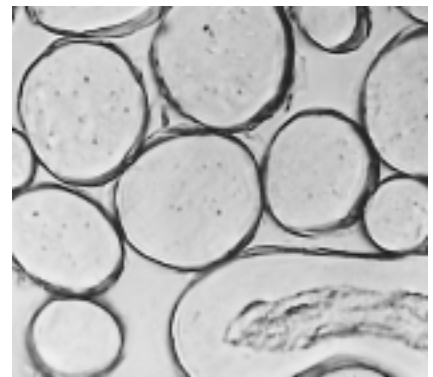

Longitudinal View 500X



Longitudinal View 500X



Longitudinal View 500X

Fig. 10—Phormium.

Fig. 11—Wool.

Fig. 12—Mohair.

Cross-Section 500X

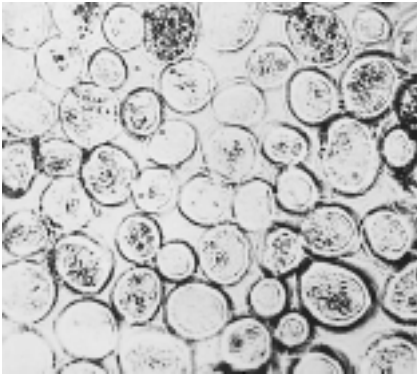

Longitudinal View 240X

Fig. 13—Cashmere.

Cross-Section 500X

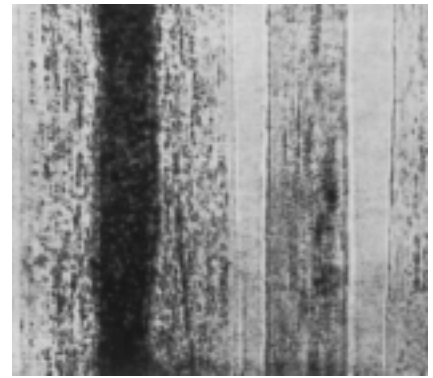
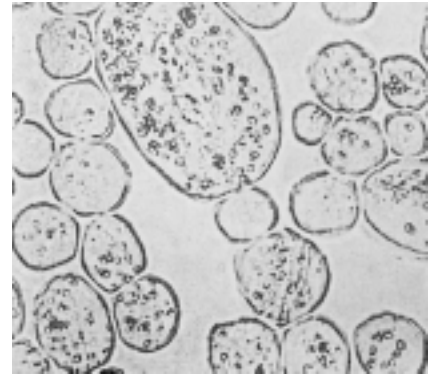

Longitudinal View 500X

Fig. 14—Camel hair.

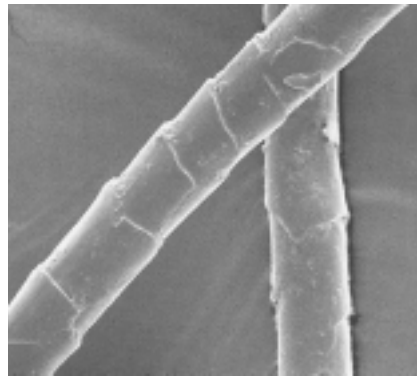

Longitudinal View 1500X

Fig. 13A—SEM (Cashmere).

Cross-Section 500X

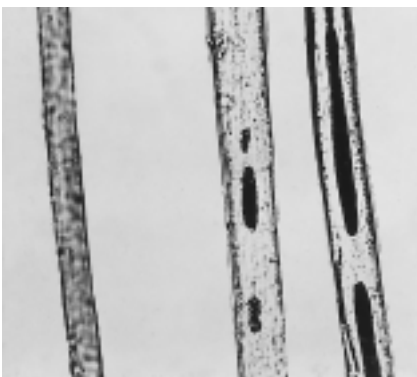
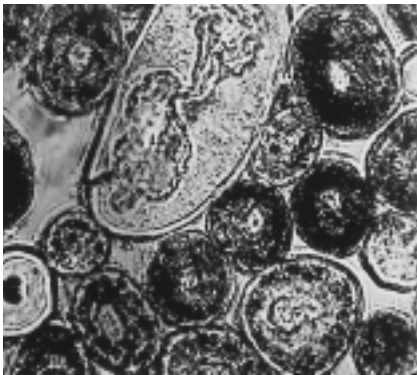

Longitudinal View 240X

Fig. 15—Alpaca.

Cross-Section 500X

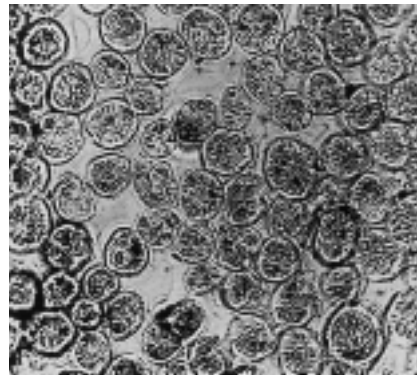

Longitudinal View 240X

Fig. 16—Vicuna.

Cross-Section 115X

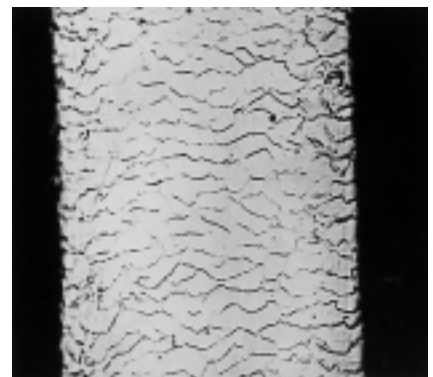
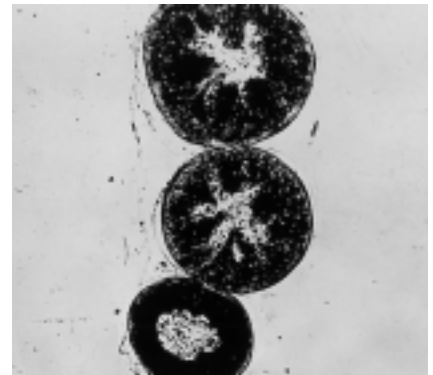

Longitudinal View 230X

Fig. 17—Horsehair.

Cross-Section 500X

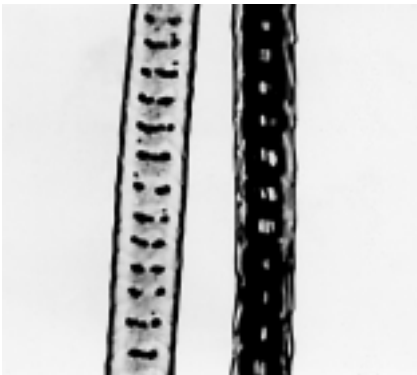
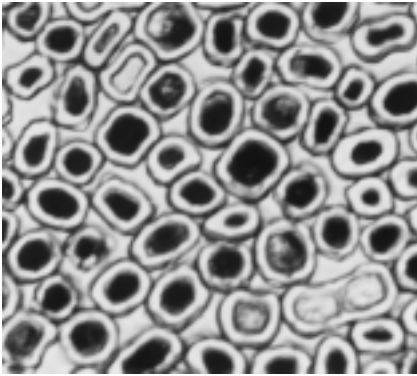

Longitudinal View 500X

Fig. 18—Rabbit fur.

Cross-Section 500X

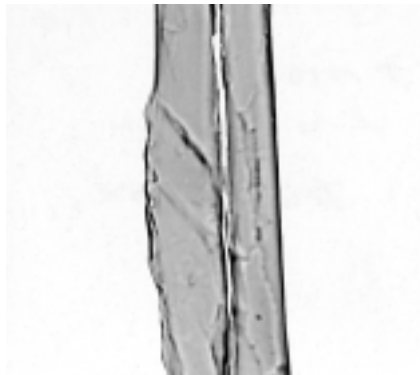
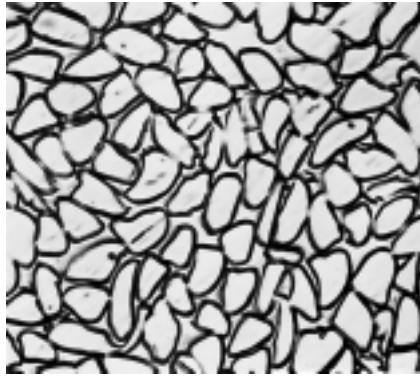

Longitudinal View 500X

Fig. 19—Silk.

Cross-Section 500X



Longitudinal View 500X

Fig. 20—Silk, tussah.

Cross-Section 500X

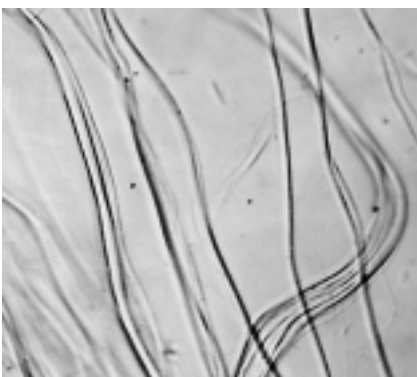
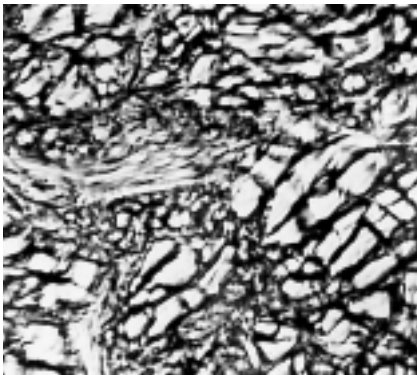

Longitudinal View 500X

Fig. 21—Asbestos.

Cross-Section 500X

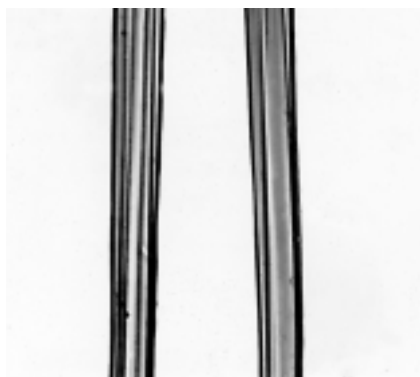
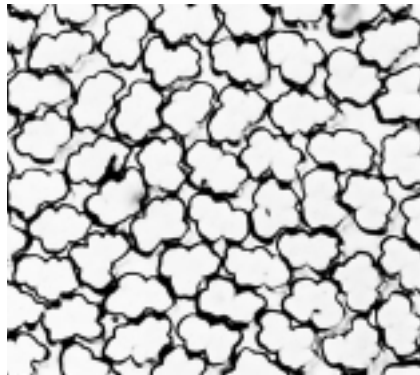

Longitudinal View 500X

Fig. 22—Acetate, secondary.

Cross-Section 500X

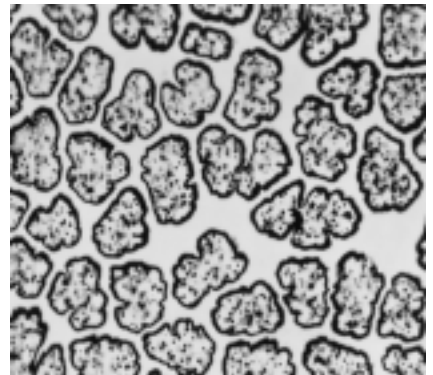

Longitudinal View 250X

Fig. 23—Triacetate, 2.5 denier (0.28 tex) per filament, dull luster.

Cross-Section 500X

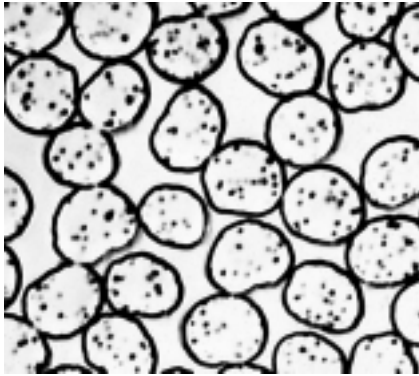

Cross-Section 500X

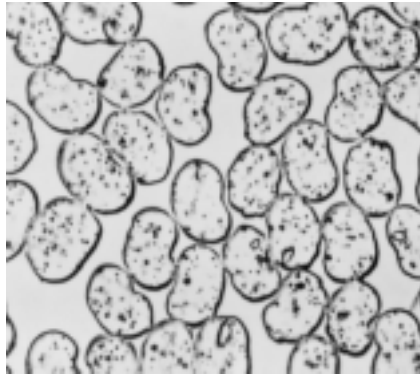

Cross-Section 500X

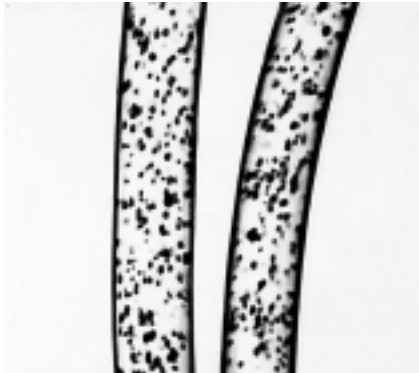

Longitudinal View 500X

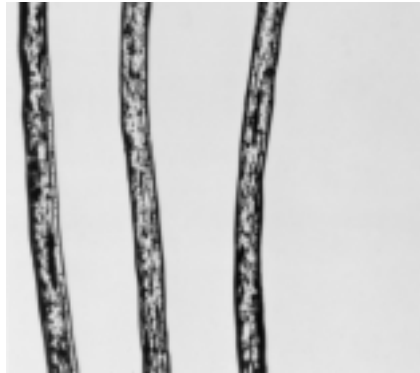

Longitudinal View 250X

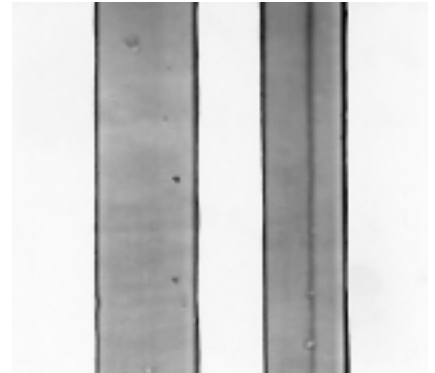

Longitudinal View 500X

Fig. 24—Acrylic, reg. wet spun, semi-dull.

Fig. 25—Acrylic, modified wet spun, 3.0 denier (0.33 tex) per filament, semi-dull luster.

Fig. 26—Acrylic, solvent spun.

Cross-Section 500X

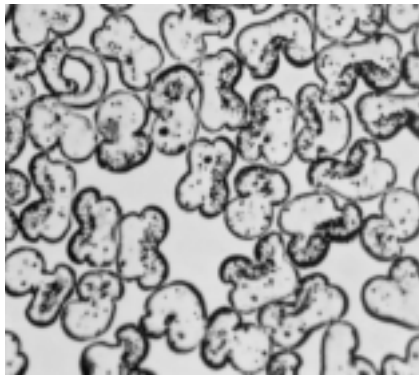

Cross-Section 100X



Cross-Section 500X

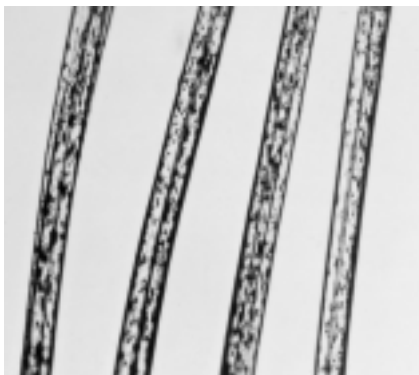
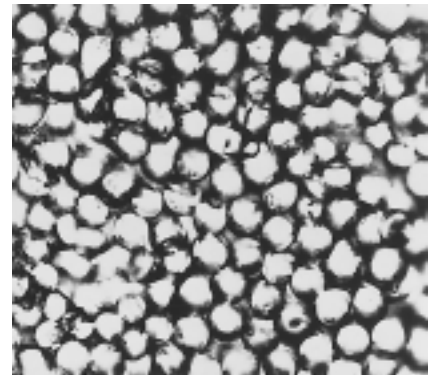

Longitudinal View 250X

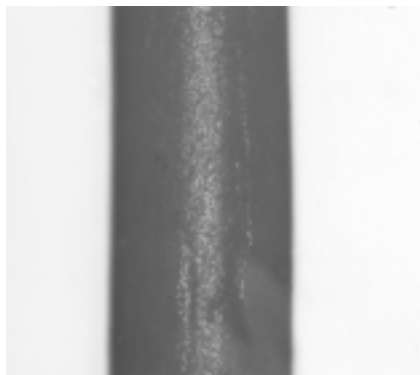

Longitudinal View 100X



Longitudinal View 250X

Fig. 27—Acrylic, two-component, 3.0 denier (0.33 tex) per filament, semi-dull luster.

Fig. 28—Anidex.

Fig. 29—Glass.

Cross-Section 100X

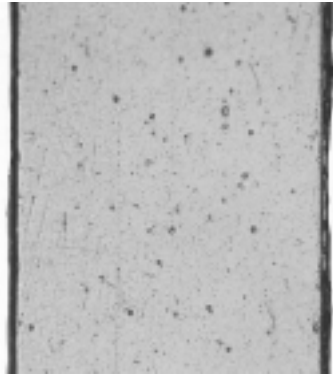
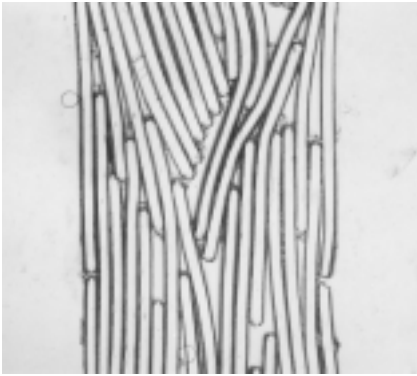

Longitudinal View 100X

Fig. 30—Metallic.

Cross-Section 500X

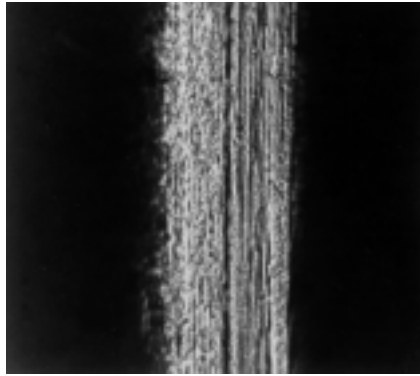
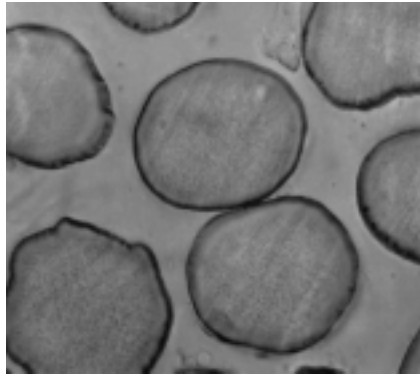

Longitudinal View 500X

Fig. 31—Modacrylic.

Cross-Section 500X

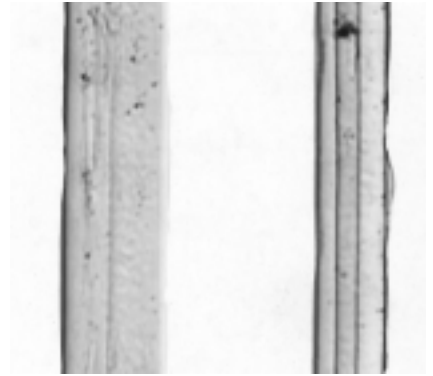
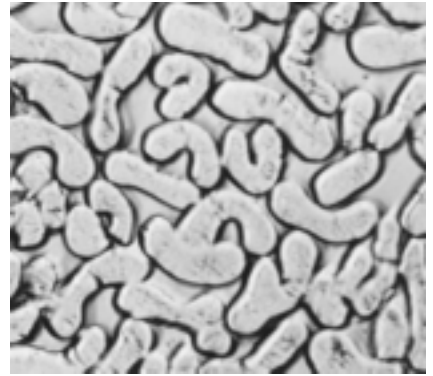

Longitudinal View 500X

Fig. 32—Modacrylic.

Cross-Section 500X

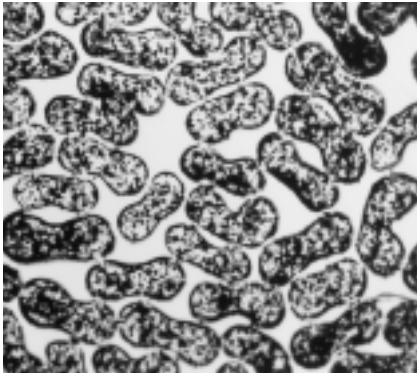

Longitudinal View 250X

Fig. 33—Modacrylic, 3.0 denier (0.33 tex) per filament, dull luster.

Cross-Section 500X



Longitudinal View 500X

Fig. 34—Modacrylic with liquid inclusions.

Cross-Section 500X

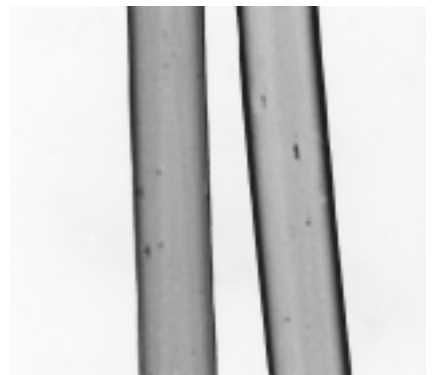
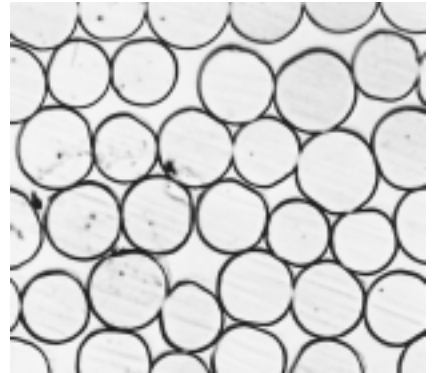

Longitudinal View 500X

Fig. 35—Nylon, bright.

Cross-Section 500X

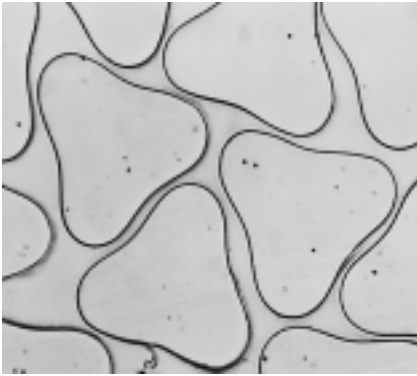

Cross-Section 500X

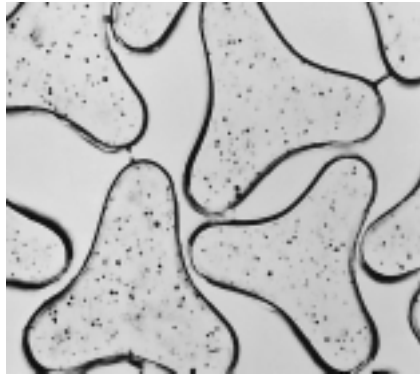

Cross-Section 500X

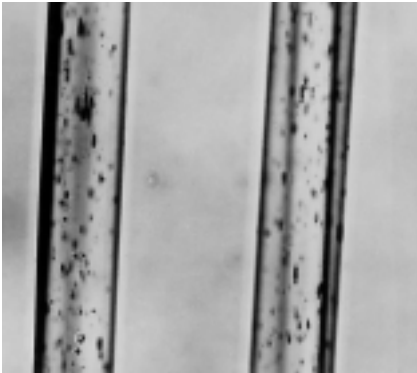
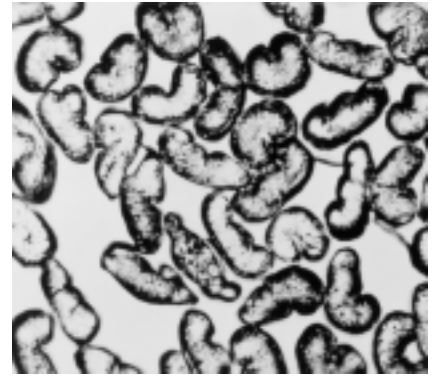

Longitudinal View 250X

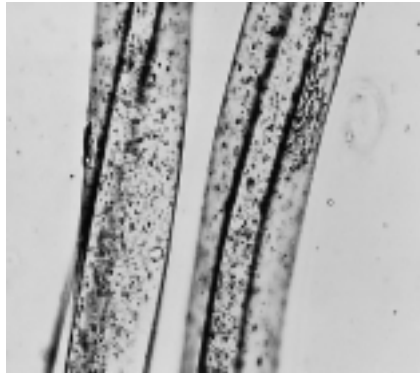

Longitudinal View 250X

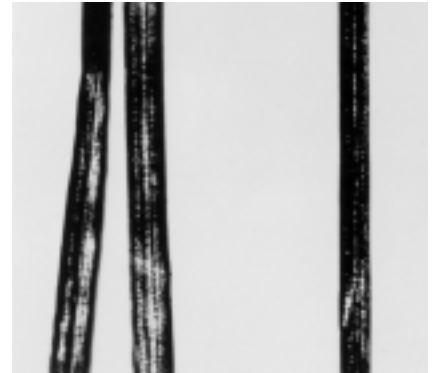

Longitudinal View 250X

Fig. 36—Nylon, low modification ratio trilobal, 15 denier (1.65 tex) per filament, bright luster.

Fig. 37—Nylon, high modification ratio trilobal, 18 denier (1.98 tex) per filament, semi-dull.

Fig. 38—Nylril, 2.0 denier (0.22 tex) per filament, dull luster.

Cross-Section 500X

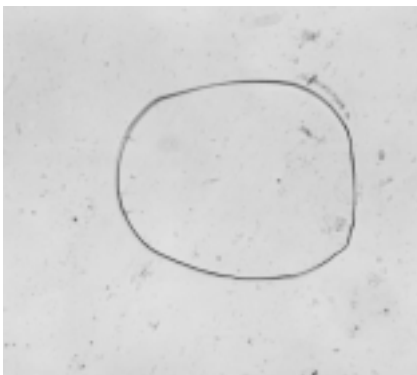

Cross-Section 500X

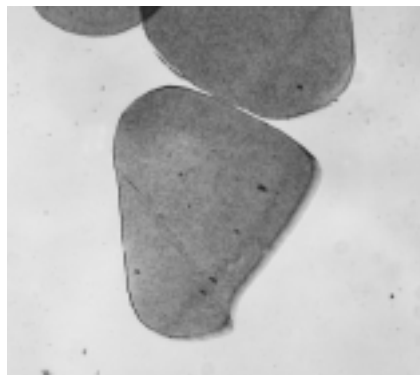

Cross-Section 500X

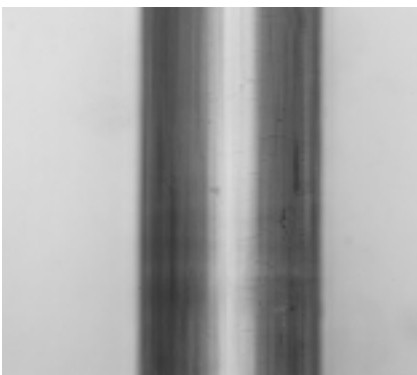
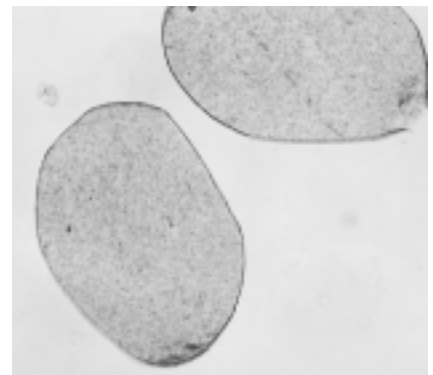

Longitudinal View 500X

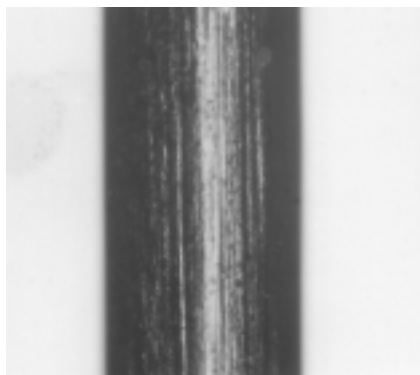

Longitudinal View 500X

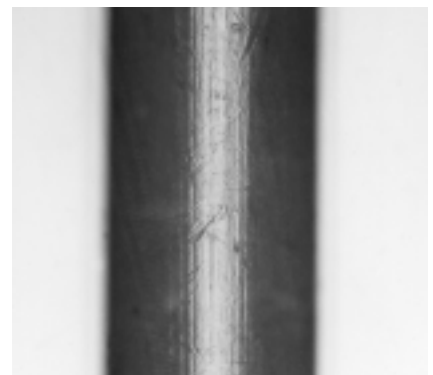

Longitudinal View 500X

Fig. 39—Polyethylene, low density.

Fig. 40—Polyethylene, medium density.

Fig. 41—Polyethylene, high density.

Cross-Section 500X

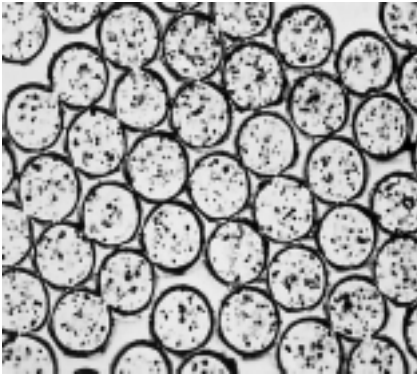

Cross-Section 500X

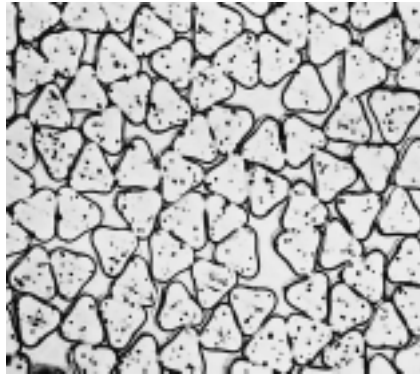

Cross-Section 500X

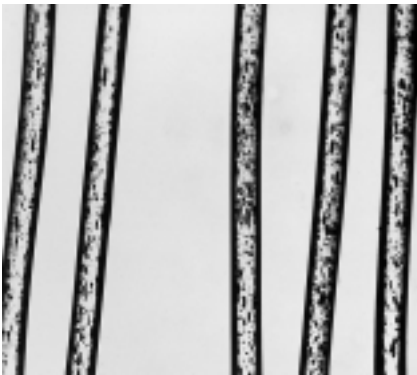
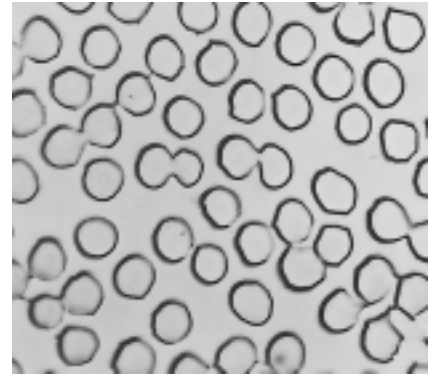

Longitudinal View 250X

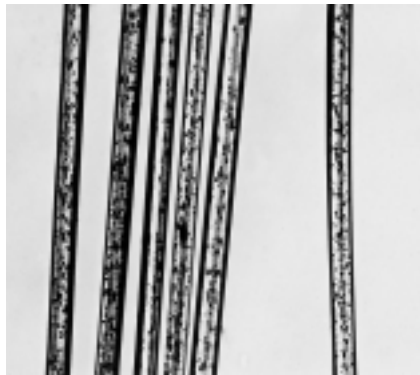

Longitudinal View 250X

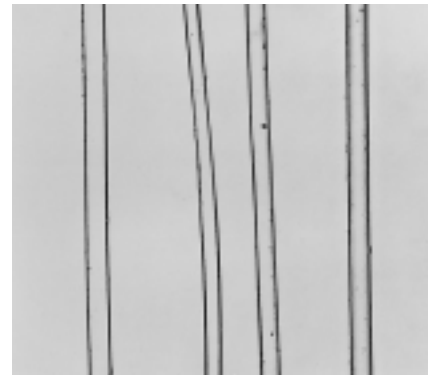

Longitudinal View 250X

Fig. 42—Polyester, regular melt spun, 3.0 denier (0.33 tex) per filament, semi-dull.

Fig. 43—Polyester, low modification ratio trilobal, 1.4 denier (0.15 tex) per filament, semi-dull luster.

Fig. 44—Rayon, cuprammonium, 1.3 denier (0.14 tex) per filament, bright luster.

Cross-Section 500X

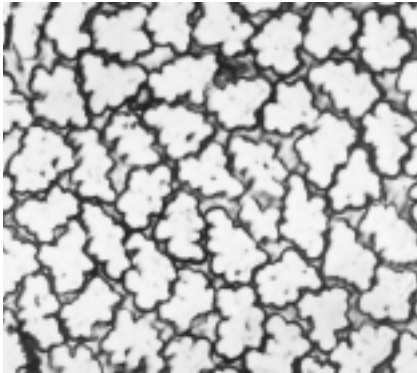

Cross-Section 500X

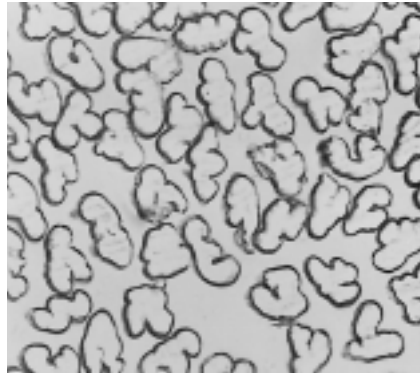

Cross-Section 500X

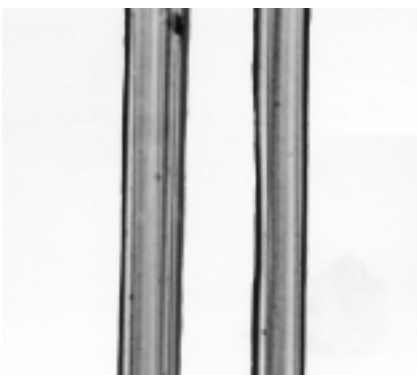
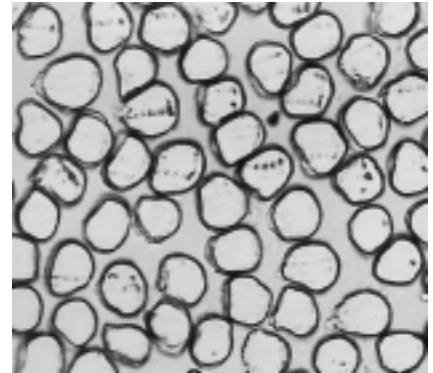

Longitudinal View 500X

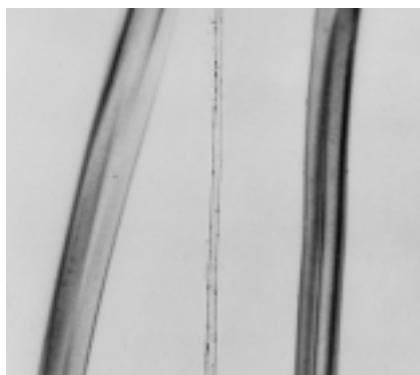

Longitudinal View 500X

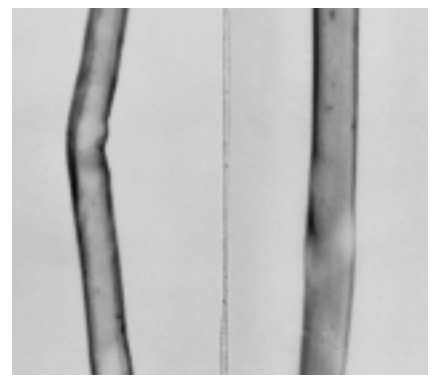

Longitudinal View 500X

Fig. 45—Rayon, viscose. Regular tenacity, brt.

Fig. 46—Rayon, viscose. High tenacity, high wet elongation.

Fig. 47—Rayon, viscose. High tenacity, low wet elongation.

Cross-Section 500X



Cross-Section 500X

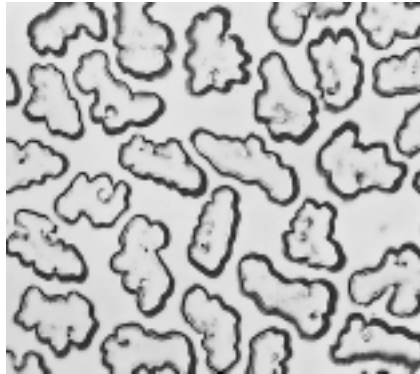

Cross-Section 500X

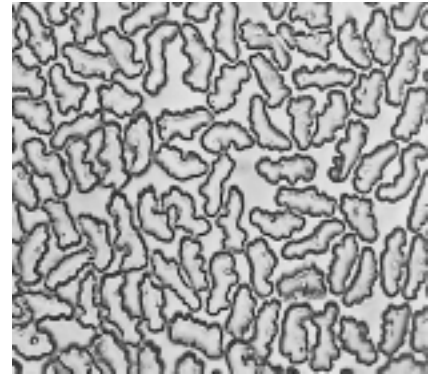

Longitudinal View 250X

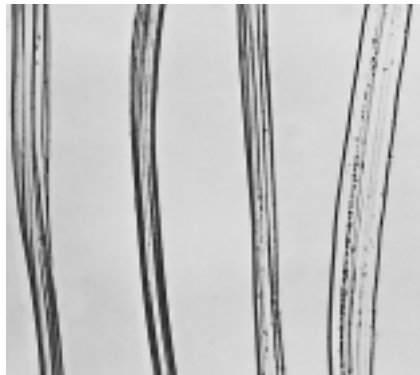

Longitudinal View 250X

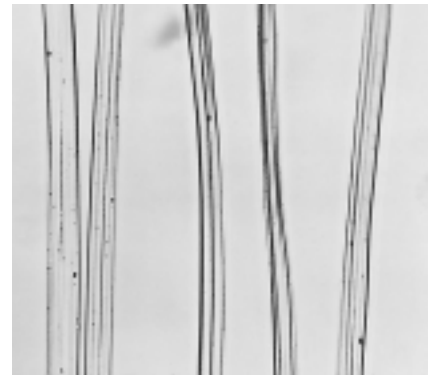

Longitudinal View 250X

Fig. 48—Rayon, saponified acetate. 0.8 denier (0.09 tex) per filament, bright luster.

Fig. 49—Rayon, viscose. Modified, 3.0 denier (0.33 tex) per filament, bright luster.

Fig. 50—Rayon, viscose. Modified, 1.5 denier (0.17 tex) per filament, bright luster.

Cross-Section 500X



Cross-Section 65X



Cross-Section 500X

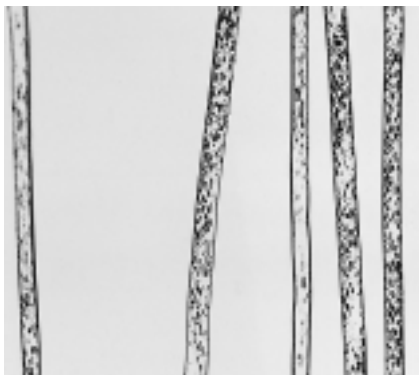
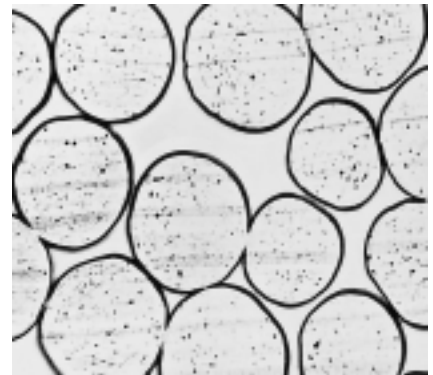

Longitudinal View 250X

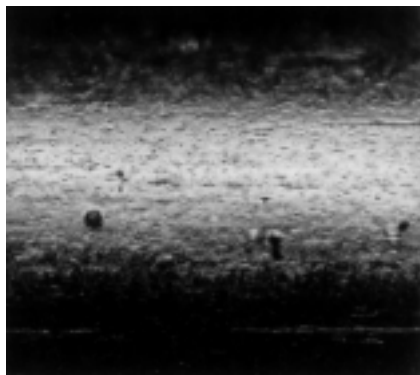

Longitudinal View 65X



Longitudinal View 250X

Fig. 51—Rayon, viscose. Modified, 1.5 denier (0.17 tex) per filament, semi-dull luster.

Fig. 52—Saran.

Fig. 53—Saran, 16 denier (1.76 tex) per filament, bright luster.

Cross-Section 500X

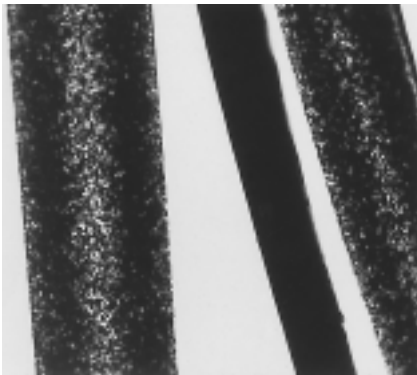
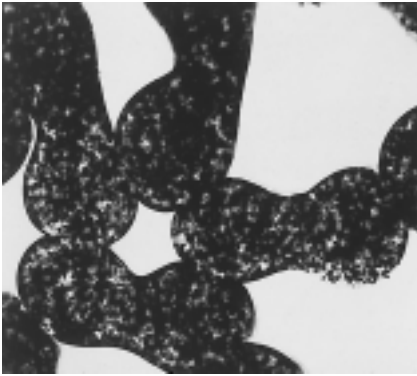

Longitudinal View 250X

Fig. 54—Spandex, adhering filaments, 12 denier (1.32 tex) per filament, dull luster.

Cross-Section 500X

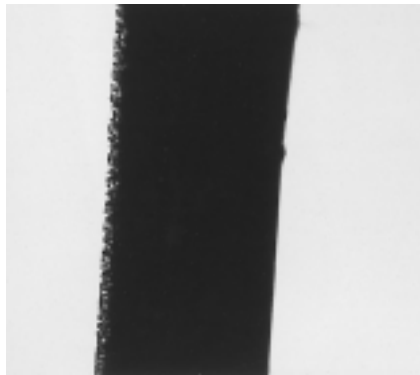

Longitudinal View 250X

Fig. 55—Spandex, coarse monofilaments, 250 denier (27.50 tex) per filament, dull luster.

Cross-Section 500X

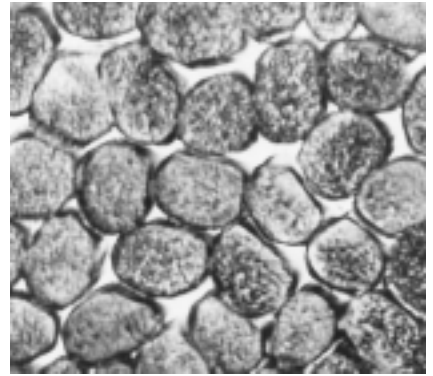

Longitudinal View 500X

Fig. 56—Fluorocarbon.

Cross-Section 500X

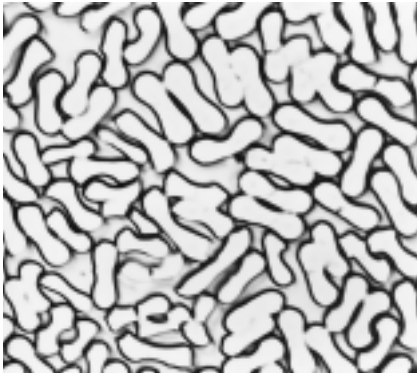

Longitudinal View 500X

Fig. 57—Vinyon.

Cross-Section 600X

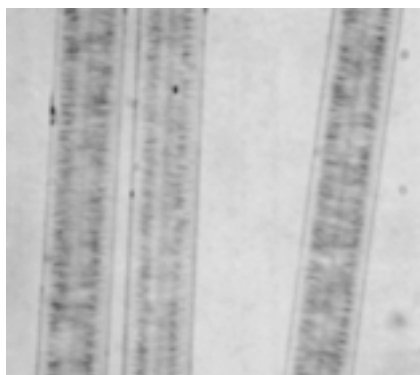
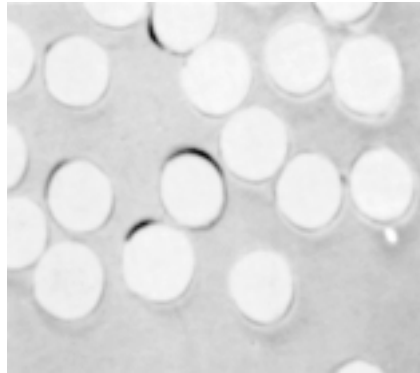

Longitudinal View 600X

Fig. 58—Aramid, round, high-tenacity filament.

Cross-Section 600X

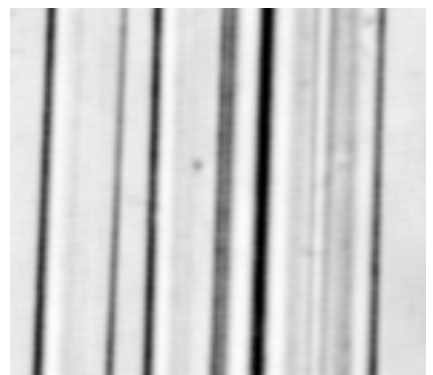

Longitudinal View 600X

Fig. 59—Aramid, FR staple fiber.

Cross-Section 500X

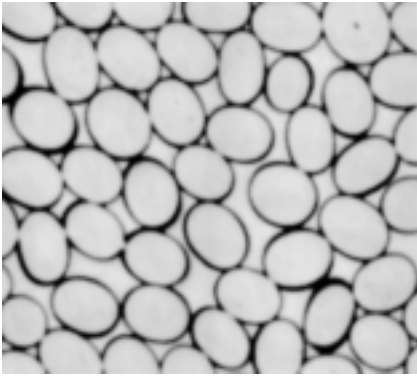

Cross-Section 1500X

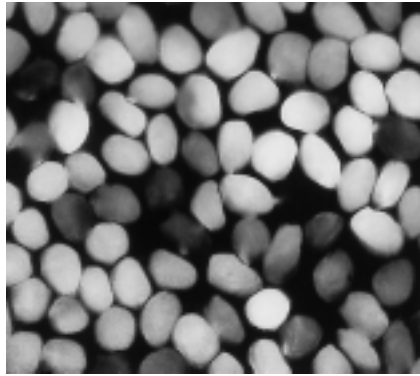

Stained Transverse Cross-Section 1800X

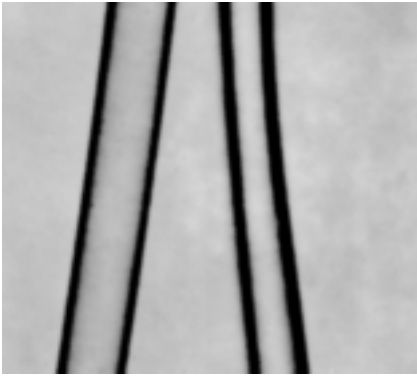
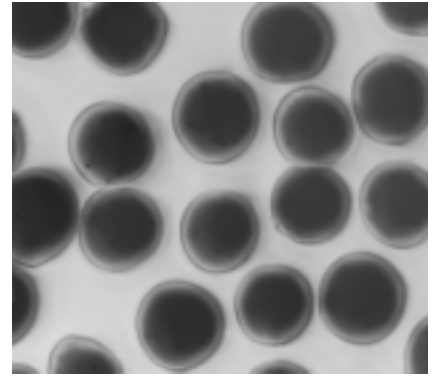

Longitudinal View 500X

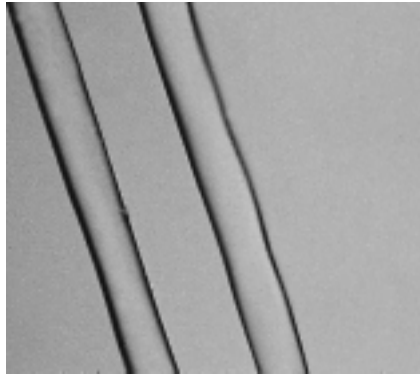

Longitudinal View 1500X

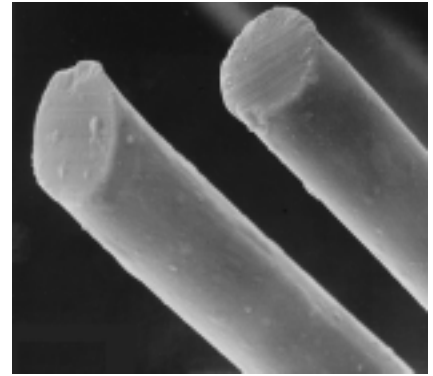

Scanning Electron Photomicrograph (10 μm)

Fig. 60—Novoloid.

Fig. 61—Permanently crimped lyocell fiber.

Fig. 62—Uncrimped lyocell fiber.

Cross-Section 500X

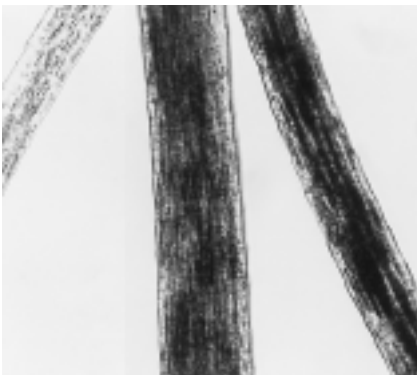
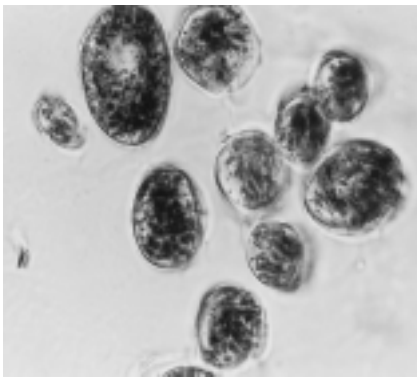

Longitudinal View 500X

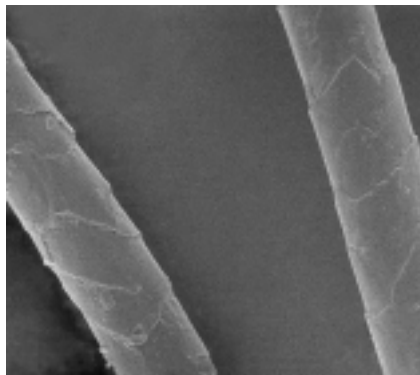

Longitudinal View 1500X

Fig. 63—Yak.

Fig. 63A—SEM of Yak.

Appendix II Micro-Fourier Transform Infrared Spectra of Common Textile Fibers

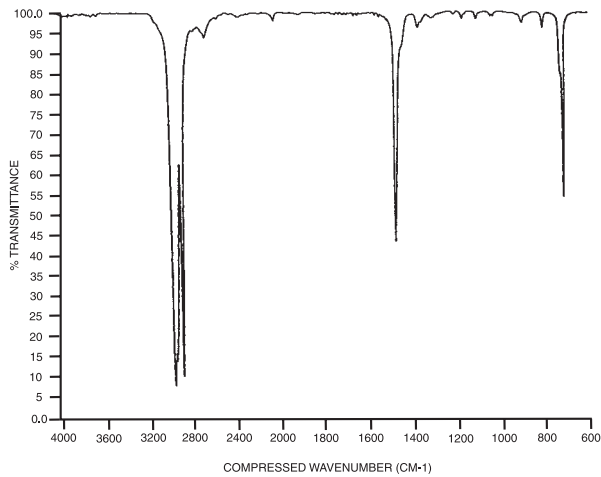

Fig. 1—Poly(ethylene) Ultra High Molecular Weight

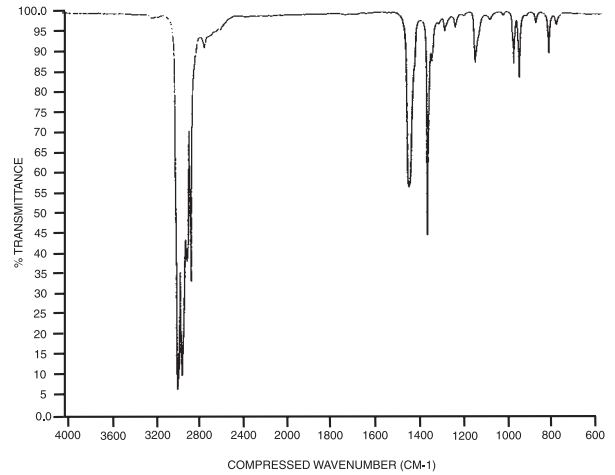

Fig. 2—Poly(propylene)

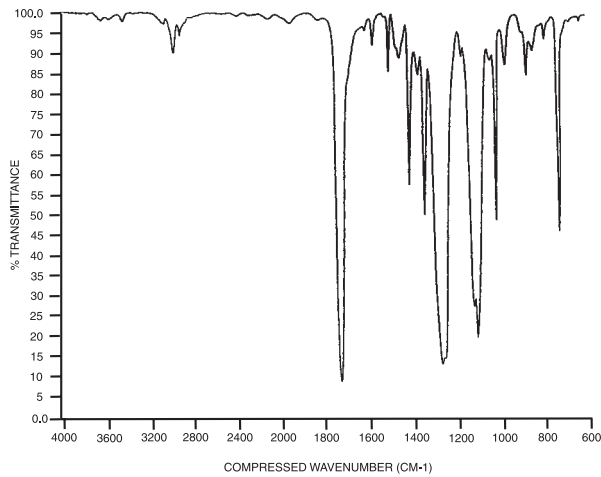

Fig. 3—Poly(ethyleneterephthalate)

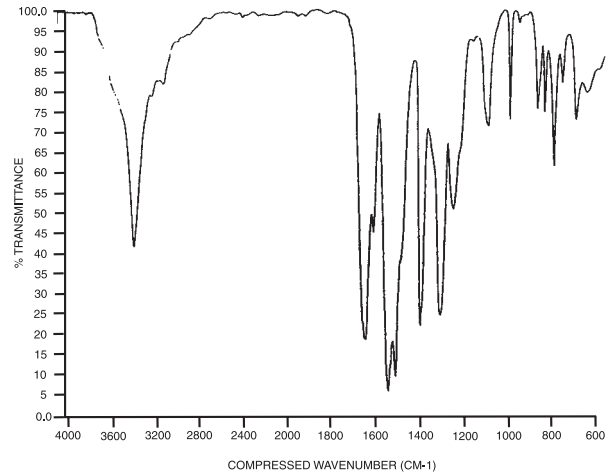

Fig. 4—Poly(phenyleneterephthalamide)

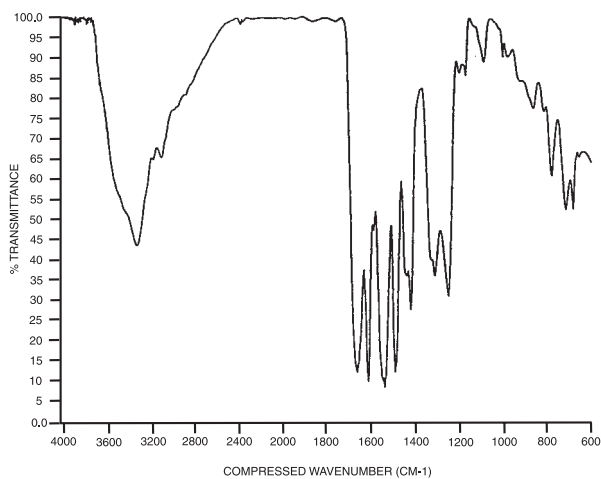

Fig. 5—Poly(m-phenyleneisophthalamide)

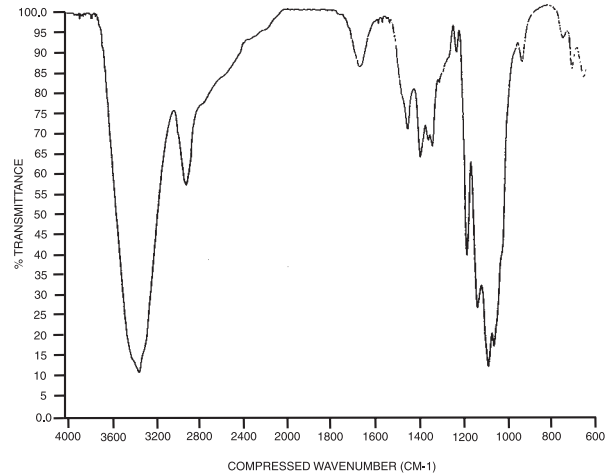

Fig. 6—Cotton

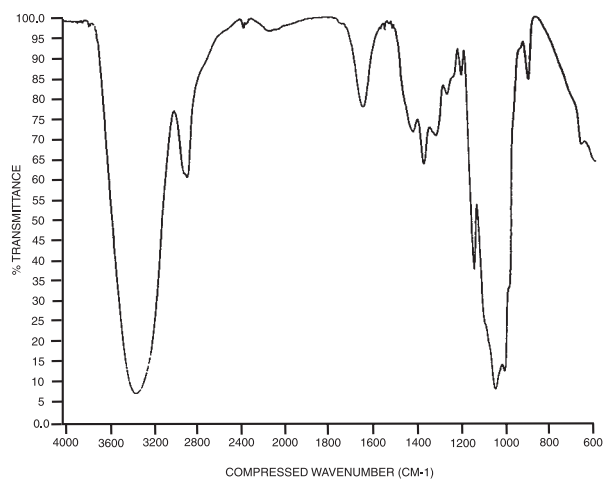

Fig. 7—Rayon

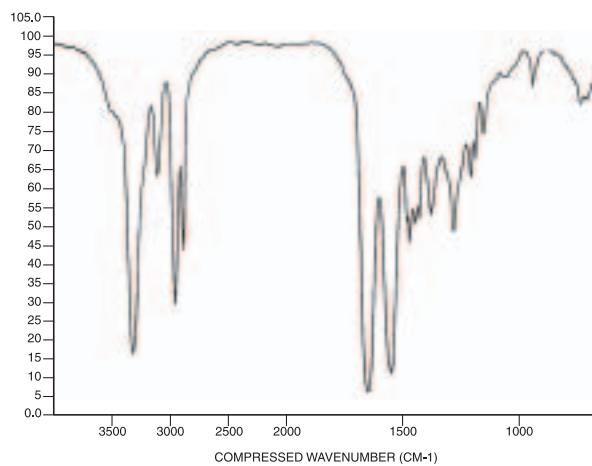

Fig. 8—Nylon 6,6 Fiber

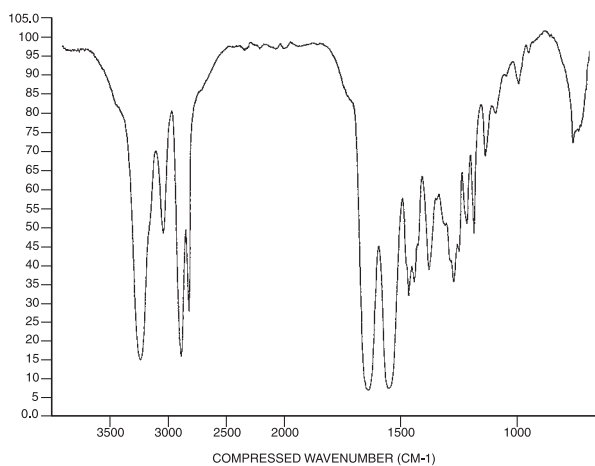

Fig. 9—Nylon 6 Fiber

Fiber Analysis: Quantitative

Developed in 1957 by AATCC Committee RA24; revised 1958, 1959, 1975, 1995, 2000, 2004, 2005; reaffirmed 1971, 1978, 1981, 1989; editorially revised 1980, 1982 (new title), 1985, 2002. Related to ISO 1833.

1. Purpose and Scope

1.1 This method presents individual procedures for the quantitative determination of moisture content, nonfibrous content and fiber composition of textiles.

1.2 The procedures for the determination of fiber composition include mechanical, chemical and microscopical methods. They are applicable to blends of the following generic classes:

Natural Fibers	Man-Made Fibers
Cotton	Acetate
Hair	Acrylic
Hemp	Modacrylic
Linen	Nylon (see 17.1)
Ramie	Olefin
Silk	Polyester
Wool	Rayon
	Spandex

2. Uses and Limitations

2.1 The procedure given for the removal of nonfibrous materials will remove most, but not all, of these components. Each treatment is applicable only to certain categories of these substances and no general scheme can be given that is all inclusive. Some of the newer finishes may present special problems and the analyst will have to deal with these cases as they arise. Thermosetting resins and crosslinking latices are not only difficult to remove but in some cases cannot be wholly removed without destroying the fiber. When it is necessary to modify a procedure, or use a new one, one should make sure that the fibrous portion of the specimen under test is not attacked. Fiber composition is generally expressed either on the oven-dry weight of the textile as received or on the oven-dry weight of the clean fiber after nonfibrous materials are first removed from the textile before the fiber analysis is carried out, or if the treatments described in Section 9 are incapable of removing them, any such materials present will increase the percentage of the fiber constituent with which they are removed during the analysis.

2.2 The procedure for determining fiber composition by mechanical separation is applicable to those textiles wherein the different fibers making up its composition are segregated in separate

yarns, or plies, in the textile product.

2.3 The chemical procedures for fiber composition described herein are applicable to most of the current, commercial production fibers within each generic class listed. Known exceptions are noted in Table II. However, there may be instances in which a method may not be fully adequate for a newly developed fiber falling within one of the listed generic classes and for re-used and/or physically or chemically modified fibers. Caution should be exercised when applying these methods to such cases.

2.4 The microscopical procedures for fiber composition are applicable to all fibers and their accuracy depends to a considerable extent upon the ability of the analyst to identify the individual fibers present. However, owing to the tedious nature of this technique, its use is generally limited to those mixtures which cannot be separated mechanically or chemically; e.g., mixtures of hair and wool and mixtures of cotton, linen, hemp and/or ramie.

3. Terminology

3.1 **clean-fiber content**, n.—the amount of fiber after removal of nonfibrous content.

3.2 **fiber**, n.—*in textiles*, a generic term for any one of the various types of matter that form the basic elements of a textile and which are generally characterized by flexibility, fineness and high ratio of length to thickness.

3.3 **moisture content**, n.—that part of the total mass of a material that is absorbed or adsorbed water, compared to the total mass.

3.4 **nonfibrous content**, n.—products such as fiber finishes, yarn lubricants, slasher sizing, fabric softeners, starches, china-clay, soaps, waxes, oils and resins which are applied to fiber, yarn, fabric or apparel.

3.5 Additional terms used in this test method can be found in standard chemical dictionaries, in dictionaries of common terms or in *A Glossary of AATCC Standard Terminology* (located elsewhere in this TECHNICAL MANUAL).

4. Safety Precautions

NOTE: These safety precautions are for information purposes only. The precautions are ancillary to the testing procedures and are not intended to be all inclusive. It is the user's responsibility to use safe and proper techniques in handling materials in this test method. Manufac-

urers MUST be consulted for specific details such as material safety data sheets and other manufacturer's recommendations. All OSHA standards and rules must also be consulted and followed.

4.1 Good laboratory practices should be followed. Wear safety glasses in all laboratory areas.

4.2 All chemicals should be handled with care.

4.3 Perform the soxhlet extractions in Section 9, Nonfibrous Material—Clean Fiber Content, using Fluorocarbon 113 (such as Freon TF) or hydrochlorofluorocarbon (such as Genesolv 2000) and ethyl alcohol inside an adequately ventilated laboratory hood. CAUTION: Ethyl alcohol is highly flammable.

4.4 Perform Chemical Analysis Procedure No. 1 (Table II, 100% acetone) inside a ventilated laboratory hood. CAUTION: Acetone is highly flammable.

4.5 Ethyl alcohol and acetone are flammable liquids and should be stored in the laboratory only in small containers away from heat, open flame and sparks.

4.6 In preparing, dispensing, and handling hydrochloric acid (20%), sulfuric acids (59.5% and 70%), and formic acid (90%) used in Chemical Analysis Procedure Methods No. 2, 3, 4, and 6 (Table II), use chemical goggles or face shield, impervious gloves and an impervious apron. Concentrated acids should be handled only in an adequately ventilated laboratory hood. CAUTION: Always add acid to water.

4.7 In preparing ammonium hydroxide (8:92) for use in Chemical Analysis Procedure Method No. 4 (Table II, 70% sulfuric acid), use chemical goggles or face shield, impervious gloves and an impervious apron. Dispense, mix and handle ammonium hydroxide only in an adequately ventilated laboratory hood.

4.8 An eyewash/safety shower should be located nearby and a self-contained breathing apparatus should be readily available for emergency use.

4.9 Exposure to chemicals used in this procedure must be controlled at or below levels set by governmental authorities (e.g., Occupational Safety and Health Administration's [OSHA] permissible exposure limits [PEL] as found in 29 CFR 1910.1000 of January 1, 1989). In addition, the American Conference of Governmental Industrial Hygienists (ACGIH) Threshold Limit Values (TLVs) comprised of time weighted averages (TLV-TWA), short term exposure limits (TLV-STEL) and ceiling limits (TLV-C)

are recommended as a general guide for air contaminant exposure which should be met (see 17.17).

5. Apparatus

5.1 Analytical balance, capable of weighing to 0.1 mg.

5.2 Oven, maintained at 105-110°C.

5.3 Desiccator, containing anhydrous silica gel, calcium sulfate (such as Driete) or its equivalent.

5.4 Soxhlet extractor, 200 mL capacity.

5.5 Constant temperature bath, adjustable, capable of controlling temperature to $\pm 1^\circ\text{C}$.

5.6 Weighing bottle, 100 mL capacity, glass, with ground glass cover. (Alternate: aluminum weighing can, same size, tight cover.)

5.7 Erlenmeyer flask, 250 mL capacity, ground glass stopper.

5.8 Beaker, borosilicate heat resistant glass, 250 mL capacity.

5.9 Filtering crucible, fritted glass, coarse porosity, 30 mL.

5.10 Suction flask, with adapter, to hold filtering crucible.

5.11 Weighing bottle, large enough to hold filtering crucible.

5.12 Microscope, equipped with a moveable stage and a cross-hair ocular, 200-250X magnification.

5.13 Projection microscope, capable of 500X magnification (see 17.12).

5.14 Fiber cutter: A device comprised of two razor blades, a threaded pin and an assemblage that will hold the blades rigidly in position. The device is operated by applying pressure vertically downward. It cuts fibers approximately 250 μm in length (see 17.3).

5.15 Wedge scale: Strips of heavy paper or Bristol board imprinted with a wedge for use at 500X magnification (see 17.4).

6. Reagents

6.1 Ethyl alcohol (95%), pure or denatured.

6.2 Fluorocarbon 113 (such as Freon TF) or hydrochlorofluorocarbon (such as Genesolve 2000).

6.3 Hydrochloric acid (HCl), 0.1*N*.

6.4 Enzyme solubilizing preparation.

6.5 Acetone (CH_3COCH_3), reagent grade.

6.6 Hydrochloric acid (HCl) (20%). Dilute HCl, sp gr 1.19, with water until the specific gravity of the solution is 1.10 at 20°C.

6.7 Sulfuric acid (H_2SO_4) (59.5%). Add H_2SO_4 , sp gr 1.84, slowly to water. After the solution has cooled to 20°C, adjust the density to a value between 1.4902 and 1.4956 g/mL.

6.8 Sulfuric acid (H_2SO_4) (70%). Add H_2SO_4 , sp gr 1.84, slowly to water. After the solution has cooled to $20 \pm 1^\circ\text{C}$, ad-

just the density to a value between 1.5989 and 1.6221 g/mL (see 17.18).

6.9 Sulfuric acid (H_2SO_4) (1:19). Slowly stir 1 volume of H_2SO_4 , sp gr 1.84, into 19 volumes of water.

6.10 Sodium hypochlorite (NaOCl). Prepare a solution of NaOCl , 5.25% available chlorine. Sodium hypochlorite based household bleach (nominally 5.25%) has been found to be acceptable.

6.11 Sodium bisulfite (NaHSO_3) (1%). Freshly prepared.

6.12 Formic acid (HCOOH) (90%), sp gr of 1.202 at 20°C.

6.13 Ammonium hydroxide (NH_4OH) (8:92). Mix 8 volumes of NH_4OH , sp gr 0.90, with 92 volumes of water.

6.14 Herzberg stain. Add the previously prepared solution A to solution B; allow to stand overnight; decant the clear liquid into a dark colored glass bottle and add a leaf of iodine.

Solution A		Solution B	
Zinc Chloride	50 g	Potassium iodide	5.5 g
Water	25 mL	Iodine	0.25 g
		Water	12.5 mL

7. Sampling

7.1 It is not possible to give specific instructions for taking a laboratory test sample from all types of textile materials to which these methods may be applicable; but a few general recommendations will be given.

7.1.1 The sample should be as representative as possible of the lot of material from which it was taken.

7.1.2 If a reasonably large lot is available, and if it is possible to do so, samplings should be taken from different, widely separated areas or parts of the lot.

7.1.3 In the case of fabrics where there is a definite repetition in the pattern, the sample should include all yarns in a complete pattern (see 17.6).

7.1.4 In the case of yarns, not less than a 2-meter length should be taken.

Test Methods

8. Moisture Content

8.1 Procedure. Place not less than 1 g of the textile to be tested in a previously tared weighing bottle and immediately replace the cover. Weigh to the nearest 0.1 mg using the analytical balance and record the weight. Place the uncovered weighing bottle containing the specimen in an oven maintained at 105-110°C for 1.5 h. At the end of the time period, remove the bottle from the oven, immediately replace the cover and put it in the desiccator. When the bottle and contents have cooled to room temperature, remove them from the desiccator and reweigh. Repeat the heating and reweighing process for periods of 30 min until the

weight is constant to within ± 0.001 g and record the constant weight.

8.2 Calculations.

8.2.1 Calculate the moisture content of the specimen as follows:

$$M = \frac{A - B}{A - T} \times 100$$

where:

M = moisture content, percent.

A = weight of sample before drying + bottle.

B = weight of sample after drying + bottle.

T = tare weight of weighing bottle.

9. Nonfibrous Material—Clean Fiber Content

9.1 Procedure. Take a specimen of not less than 5 g, dry it to constant weight in an oven at 105-110°C (see 8.1), record the oven-dry weight to the nearest 0.1 mg using an analytical balance and then subject it to one, or more, of the following treatments, as appropriate. When specific type of nonfibrous content is known, only that specific treatment, or treatments, need be performed; otherwise, all treatments must be applied.

9.1.1 Hydrochlorofluorocarbon Treatment (for removal of oils, fats, waxes, certain thermoplastic resins, etc.). Extract the dried specimen with hydrochlorofluorocarbon in a soxhlet extractor, siphoning over a minimum of six times. Air dry, and then dry at 105-110°C to constant weight. For an alternative to soxhlet extractor, see 17.19.

9.1.2 Alcohol Treatment (for removal of soaps, cationic finishes, etc.). Extract the dried specimen with ethyl alcohol in a soxhlet extractor, siphoning over a minimum of six times. Air dry, and then dry at 105-110°C to constant weight. For an alternative to soxhlet extractor, see 17.19.

9.1.3 Aqueous Treatment (for removal of water soluble materials). Immerse the dried specimen for 30 min in water at 50°C using a 100:1 liquid to fabric ratio. Stir occasionally or use a mechanical shaker. Rinse 3 times in fresh portions of water and dry at 105-110°C to constant weight.

9.1.4 Enzyme Treatment (for removal of starch, etc.). Immerse the dried specimen in aqueous solution of the enzyme preparation following the manufacturer's recommendations as to concentration, liquid to fabric ratio and temperature and time of immersion. Rinse thoroughly with hot water and dry at 105-110°C to constant weight.

9.1.5 Acid Treatment (for removal of amino resins). Immerse the dried specimen in 100 times its weight of 0.1*N* HCl at 80°C for 25 min, stirring occasionally. Rinse thoroughly with hot water and dry at 105-110°C to constant weight.

9.2 Calculations.

Table I—Chemical Methods for Analysis of Fiber Mixtures

	Wool	Silk	Rayon	Polyester	Olefin	Nylon	Mod-acrylic	Hair	Cotton, Hemp, Linen, Ramie	Acrylic	Spandex
Acetate	1 4 (5)	1 (5)	1	1 4	1	1 (2)		1 (5)	1	1	
Acrylic	(5)	(3) (5)	(3)			(2) (3) (6)	(1)	(5)			
Cotton, Hemp, Linen, Ramie	4 (5)	(3) (5)	(3)	4		(2) (3) (6)	(1)	(5)			(7)
Hair			5	5	5	(2) 5 6	(1) 5				
Modacrylic	1 (5)	1 (3) (5)	1 (3)	1	1	1 (2) (3) (6)					
Nylon	2 3 (5) 6	(5)	2 6	2 3 6	2 6						2**
Olefin	(5)	(5)									
Polyester	(5)	(3) (4) (5)	(3) (4)								
Rayon	3 4 (5)	(5)									
Silk	3 4										

- 1 *100% acetone: section 12.1
- 2 20% hydrochloric acid: section 12.2
- 3 59.5% sulfuric acid: section 12.3
- 4 70% sulfuric acid: section 12.4
- 5 sodium hypochlorite: section 12.5
- 6 90% formic acid: section 12.6
- 7 dimethylformamide: section 12.7

*Not suitable for all modacrylic fibers

**Not suitable for all nylon fibers

Section 11.2 contains details of table use.

9.2.1 Calculate the nonfibrous content of the specimen as follows:

$$N = \frac{C-D}{C} \times 100$$

where:

- N* = nonfibrous materials, percent.
- C* = dry weight, specimen, before treatment.
- D* = dry weight, specimen, after treatment.

9.2.2 Calculate the clean fiber content of the specimen as follows:

$$F = \frac{D}{C} \times 100$$

where:

- F* = clean fiber content, percent; other terms as in 9.2.1

10. Mechanical Separation

10.1 Procedure. Remove the nonfibrous materials using the appropriate treatment (see 9.1). Separate the component yarns by mechanical dissection; combine those yarns, or plies, having the same fiber composition and determine

the oven-dry weight of each generic type present.

10.2 Calculation. Calculate the content of each generic fiber as follows:

$$X_i = \frac{W_i}{E} \times 100$$

where:

- X_i* = content of fiber *i*, percent.
- W_i* = oven-dry weight of fiber *i*, after separation.
- E* = weight of clean, oven-dry specimen taken for analysis.

11. Chemical Analysis—General

11.1 Specimen Preparation. Before analyses are undertaken, the laboratory test sample should be disintegrated, homogenized and a portion of the homogenate taken for the chemical treatment(s). In the case of a fabric, one should unravel it into its individual yarns, cut the yarns into lengths not greater than 3 mm, thoroughly mix the cut pieces and then take a representative portion for the specific determination. An alternate procedure, suitable in many cases, is to grind the sample using a Wiley Mill, homoge-

nize the ground fibers by slurring them in a water suspension in a Waring Blender and taking the representative portion from the dried homogenate for the specific determination. Yarns are treated the same way but omitting the unnecessary steps.

11.2 Method Application. A tabulation of appropriate chemical treatments for binary fiber mixtures is given in Table I. To use this table one enters at the left side on the line listing one of the components of the binary mixture and moves to the box under the column listing the other component and the number therein is the method, or methods, that are applicable for that specific combination. The unbracketed methods are those that dissolve the fiber at the left side of the diagram while the bracketed ones dissolve the fiber at the top of the diagram. Mixtures of more than two components may be analyzed by proper application of a sequence of the individual methods. Table II presents the relative solubilities of the various fibers in all the reagents and, from this, one can select the proper methods and their sequence for the analysis of multifiber mixtures (see 17.7).

Table II—Solubilities of Fibers in Reagents Used in the Chemical Methods

	Chemical Method					
	No. 1 100% CH ₃ COCH ₃	No. 2 20% HCl	No. 3 59.5% H ₂ SO ₄	No. 4 70% H ₂ SO ₄	No. 5 NaOCl	No. 6 90% HCOOH
Acetate	S		S	S		S
Acrylic				I*		
Cotton			SS	S		
Hair					S	
Hemp			SS	S		
Linen			SS	S		
Modacrylic	S or I*					
Nylon		S	S	S		S
Olefin						
Polyester						
Ramie			SS	S		
Rayon			S	S		
Silk		PS	S	S	S	PS
Wool					S	

*Depending on type

KEY TO SYMBOLS: S = SOLUBLE
 PS = PARTIALLY SOLUBLE (Method not applicable)
 SS = SLIGHTLY SOLUBLE (Useable but correction factor required)
 I = INSOLUBLE

Section 11.2 contains details of table use.

12. Chemical Analysis Procedures

12.1 Method No. 1, 100% Acetone: Weigh accurately a 0.5-1.5 g portion of the clean, dry, prepared specimen and record the weight to the nearest 0.1 mg. Transfer into a 250 mL Erlenmeyer flask. Add 100 times its weight of acetone and agitate vigorously for 15 min keeping the temperature at 40-50°C. Decant the liquid from the undissolved residue, add a fresh portion of acetone and agitate for a few more minutes. Repeat the decanting and agitation process one more time and then filter the undissolved residue by suction through a dried weighed, fritted-glass, filtering crucible. Dry the crucible and residue in air and then in an oven at 105-110°C to constant weight. Record the weight of the dried residue to the nearest 0.1 mg.

12.2 Method No. 2, 20% Hydrochloric acid: Weigh accurately a 0.5-1.5 g portion of the clean, dry, prepared specimen and record the weight to the nearest 0.1 mg. Transfer into a 250 mL Erlenmeyer flask. Add 50-150 mL of 20% hydrochloric acid (100 mL reagent/g of sample); shake vigorously and let stand for 5 min at 15-25°C. Shake again and let stand for 15 min. Shake for a third time (see 17.8) and filter the mixture through a dried weighed fritted-glass crucible. Wash into the crucible any residue left in the flask using a little more 20% hydrochloric acid. Apply suction to drain the excess liquor from the filter residue. Wash the residue in the crucible with about 40 mL of 20% hydrochloric acid and then with water until the filtrate is neutral to litmus. Disconnect the suction and add to the crucible about 25 mL of ammonium hy-

droxide (8:92) allowing the fiber residue to soak for 10 min before applying suction to drain it. Wash the residue with about 250 mL of water, allowing it to soak in the water for about 15 min. After the final washing, apply suction to remove rinse water, and dry the crucible and residue in an oven at 105-110°C to constant weight. Record the dry weight to the nearest 0.1 mg.

12.3 Method No. 3, 59.5% Sulfuric acid: Weigh accurately a 0.5-1.5 g portion of the clean, dry, prepared specimen and record the weight to the nearest 0.1 mg. Transfer into a 250 mL Erlenmeyer flask. Add 50-150 mL of 59.5% sulfuric acid (100 mL reagent/g of sample) and shake vigorously for 1 min. Let stand for 15 min at a temperature of 15-25°C. Shake again and let stand for another 15 min, shake for a third time (see 17.8) and then filter the mixture through a dried weighed fritted-glass crucible. Wash into the crucible any residue left in the flask using three 10 mL aliquots of 59.5% sulfuric acid. Apply suction to drain the excess liquor from the fiber residue after the addition of each aliquot. Wash the residue in the crucible with 50 mL of sulfuric acid (1:19), then with water until the filtrate is neutral to litmus. Disconnect the suction and add to the crucible about 25 mL of ammonium hydroxide (8:92), allowing the fiber residue to soak for 10 min before applying suction to drain it. Wash the residue with about 150 mL of water, allowing it to soak in the water for about 15 min. After the final washing, apply suction to remove the rinse water and dry the crucible and fiber residue in an oven at 105-110°C to constant weight. Record the weight of the

dried residue to the nearest 0.1 mg (see 17.9).

12.4 Method No. 4, 70% Sulfuric acid: Weigh accurately a 0.5-1.5 g portion of the clean, dry, prepared specimen and record the weight to the nearest 0.1 mg. Transfer into a 250 mL Erlenmeyer flask. Add 50-150 mL of 70% sulfuric acid (100 mL reagent/g of sample) and shake vigorously for 1 min. Let stand for 15 min at a temperature of 15-25°C. Shake again and let stand for another 15 min; shake for a third time (see 17.8) and then filter the mixture through a fritted-glass crucible which has been oven-dried, cooled in a desiccator and weighed to 0.1 mg. Wash into the crucible any residue left in the flask using three 10 mL aliquots of 70% sulfuric acid. Apply suction to drain the excess liquor from the fiber residue after the addition of each aliquot. Wash the residue in the crucible with 50 mL of sulfuric acid (1:19), then with water until the filtrate is neutral to litmus. Disconnect the suction and add to the crucible about 25 mL of ammonium hydroxide (8:92); allow the fiber residue to soak for 10 min before applying suction to drain it. Wash the residue with about 150 mL of water, allowing it to soak in the water for about 15 min. After the final washing, apply suction to remove excess water and dry the crucible and fiber residue in an oven at 105-110°C to constant weight. Record the weight of the dry residue to the nearest 0.1 mg.

12.5 Method No. 5, Sodium hypochlorite: Weigh accurately a 0.5-1.5 g portion of the clean, dry, prepared specimen and record the weight to the nearest 0.1 mg. Transfer into a 250 mL Erlenmeyer flask. Add 50-150 mL of sodium hypochlorite reagent (100 mL reagent/g of sample). Stir the specimen in this solution for 20 min making sure the temperature is maintained at 25 ± 1°C (use constant temperature bath) (see 17.10) and then filter through a dried weighed, fritted-glass crucible. Wash thoroughly with sodium bisulfite (1%) followed by water and remove the excess water by suction. After the final washing, apply suction to remove excess water and dry in an oven at 105-110°C to constant weight. Record the weight of the dried residue to the nearest 0.1 mg.

12.6 Method No. 6, 90% Formic acid: Weigh accurately a 0.5-1.5 g portion of the clean, dry, prepared specimen and record the weight to the nearest 0.1 mg. Transfer into a 250 mL Erlenmeyer flask. Add 50-150 mL of 90% formic acid (100 mL reagent/g of sample) and shake frequently over a period of 15 min (see 17.11). Decant the supernatant liquid into a dried, weighed, fritted-glass crucible, add another equal portion of 90% formic acid to the flask and agitate for an additional 15 min. Filter the contents of the

flask through the crucible, rinse with two 50 mL portions of 90% formic acid and drain with the aid of suction. Wash the residue with 50 mL of water and then allow it to soak in 25 mL of ammonium hydroxide (8:92) for about 10 min. Wash the residue thoroughly with water until the filtrate is neutral to litmus. Drain the residue with the aid of suction and dry in an oven at 105-110°C to constant weight. Record the weight of the dried residue to the nearest 0.1 mg.

12.7 Method No. 7, Dimethylformamide: Weigh accurately a 0.5-1.5 g portion of the clean, dried, prepared specimen and record the weight to the nearest 0.1 mg. Transfer to a 250 mL Erlenmeyer flask. Add 50-150 mL of dimethylformamide reagent (100 mL reagent/g of sample). Agitate for 20 min keeping the temperature at $98 \pm 1^\circ\text{C}$. Decant the liquid from the undissolved residue, add a fresh portion of dimethylformamide and agitate for a few more minutes. Repeat the decanting and agitation process one more time and then filter the undissolved residue by suction through a dried, weighed fritted glass filtering crucible. Dry the crucible and residue in air and then in an oven at 105-110°C to constant weight. Record the weight of the dried residue to the nearest 0.1 mg.

12.8 Calculations: Calculate the content of each generic fiber type as determined by any one of the above applicable chemical methods using one of the following equations:

12.8.1 If the fiber is *dissolved* by the test reagent:

$$X_i = \frac{G - H_i}{G} \times 100$$

12.8.2 If the fiber is insoluble in the test reagent:

$$X_i = \frac{H_i}{G} \times 100$$

where:

X_i = content of fiber i , percent.

G = weight of clean, dry, prepared specimen

H_i = weight of dried residue after treatment

13. Microscopical Analysis, General

13.1 The following procedure may be used for the quantitative analysis of textiles containing two or more fiber types which cannot be separated readily by mechanical or chemical methods. The procedures rely on the ability of a technician to identify and count, by means of a microscope, the relative number of fibers of each type in a prepared specimen. Such a count will result in a percent blend by *number* of fibers. In order to convert this

result to a percent by weight, the size of the fibers being counted and their respective densities must be included in the calculation.

13.2 Microscope slides may be prepared to scan longitudinal or cross-section views of a fiber sample. The fiber images may be viewed either through a microscope or as projected onto a horizontal plane. While either viewing method may be used for identification and counting of fibers, the projection method is specifically used for measuring fiber diameters using a wedge scale (see 14.3.2).

13.3 Methods which may be used to identify fibers during the fiber counting procedures are discussed in AATCC Test Method 20. They include the following:

	AATCC 20
Herzberg stain (zinc chloroiodide)	Section 9.9.1
Acid phloroglucinol reagent	Section 9.9.2
Longitudinal appearance	Tables I and II
Cross-section appearance	Tables I and II and Appendix I

It is recommended that reference tests be made on known fibers rather than placing total reliance on photographic reproductions and word descriptions of colors.

14. Microscopical Analysis Procedures

14.1 Preparation of Slides.

14.1.1 Longitudinal Sections of Vegetable Fibers (cotton, flax, ramie, etc.): A swatch of fabric measuring at least 5×5 cm should be available. Count the number of yarns in both the warp and filling and select from each direction at random a number of yarns that is proportional to the fabric count. The combined number of warp and filling yarns should total at least 20 (see 17.12). If the sample is in yarn form, take at least a two-meter length and, from it, cut not less than twenty 5-cm sections at random. Cut approximately 2.5 cm of each yarn, or yarn section, into lengths of 0.5-1 mm. The shorter the lengths the easier it is to prepare a homogeneous fiber suspension. Collect the cut fibers on a paper of contrasting color and transfer to a 125 mL Erlenmeyer flask. Add sufficient water so that after stoppering the flask and shaking the contents, a uniform and fairly dense fiber suspension is obtained. Quick boiling or the addition of a few glass pellets facilitates the separation of the fibers. Using a glass-marking pencil, draw two parallel lines about 1 in. apart across a glass slide. With a wide-mouth pipette, draw 0.5-1 mL of the well shaken suspension and place it between the two reference lines on the slide. The amount of liquid taken is dependent upon the density of the suspension. Just sufficient liquid should be placed on the slide so that—after evaporation—a thin, uniform film of

fibers remains. After all of the moisture has evaporated from the slide, stain the fibers with Herzberg stain and cover with a cover glass.

14.1.2 Longitudinal Sections of Wool, Hair and other round Fibers: Select a representative swatch, or yarn sections, as in 14.1.1. With a fabric swatch, remove the outermost yarns in both directions so that the warp and filling yarns are protruding approximately 1 cm. Lay the sample flat on a table and, using a fiber cutter, force the blades vertically downward into the warp fringe. Repeat the operation with the filling fringe. Remove the device with the top plate up, release the tension on the cutting blades and remove them together by their ends between the thumb and forefinger. Carefully separate the blades so that the cut fiber sections will adhere to the edge of one or both blades. Place a few drops of mineral oil on a clean slide and, with a dissecting needle, scrape the fiber sections onto the oil. Thoroughly disperse the fibers in the oil with the dissecting needle and cover with a cover glass. For yarn samples, align the sections side-by-side and perform the above operation starting with the use of the fiber cutter.

14.1.3 Cross-Sections of Fibers: Select representative yarns, or yarn sections, from the sample and render them to staple by removing twist and drawing out fibers. Align the fibers parallel to each other so as to form a well blended tuft. Prepare a slide following the instructions of AATCC Test Method 20, Section 9.3.

14.2 Fiber Counting.

14.2.1 Fibers Viewed Through Microscope: Place the slide prepared as in 14.1 on the moveable stage on a microscope equipped with a crosshair ocular and having a magnification of 200-250X. Begin to count near either the upper or lower corner of the field and, as the slide is moved slowly across the field in the horizontal direction, identify and count all fibers passing through the center of the crosshairs. After each trip across the field, move the slide 1-2 mm vertically and identify and count the fibers as the field is again traversed. Repeat this procedure until the whole slide has been covered. The spacing between each traverse is dependent upon the number of fiber sections on the slide. If a fiber passes the crosshair more than once, record each passing (see 17.13). In a similar manner, count the fibers by moving the slide vertically. The combined horizontal and vertical counts should total at least 1000 fibers.

14.2.2 Projected Images of Fibers: Calibrate the microprojector so that it will give a magnification of 500X in the plane of the projected image. To do this, place a stage micrometer (having units of 0.01 mm) on the stage of the micro-

projector with its scale toward the objective and place a large sheet of white, non-glare paper in the projection plane. Lower or raise the microscope until an interval of 0.20 mm on the stage micrometer will measure 100 μm when sharply focused in the center of the paper. Place the slide prepared as in 14.1 on the stage of the microprojector with the cover glass toward the objective. Draw a 10-cm diameter circle in the center of the white paper in the projection plane. All measurements and counts are to be made within this circle. Begin to count near either the upper or lower corner of the field and proceed exactly as described in 14.2.1 (see 17.14).

14.2.3 Video Imaging of Fibers: Using a video monitor with a crosshair placed in the center of the screen coupled to a video camera attached to a correctly adjusted transmitted light microscope scan the slide as outlined in 14.2.1.

14.3 Fiber Measurement.

14.3.1 Fibers with Noncircular Cross-Sections:

14.3.1.1 Paper Tracing Method: Prepare a slide as described in 14.1.3. Place this slide on the stage of the microprojector and project the image onto a sheet of graph paper having one millimeter squares. Trace the image of the fibers on the graph paper using a sharpened pencil, taking care not to retrace fibers previously traced. If there are not sufficient fibers on the slide to provide 100 of each type, prepare another slide as described above using another tuft of fibers. Continue to trace and to count on the new slide until 100 fibers of each type have been tallied. By counting squares, and parts of squares, determine the cross-sectional area of each individual fiber of each type. Calculate the mean cross-sectional area for each fiber type present by summing the individual values recorded for that type and dividing the sum by the total number of fibers of that type measured. Final values should be in mm².

14.3.1.2 Digital Tracing Method: Prepare a slide as described in 14.1.3. Place this slide on the stage and adjust until a clear well formed image appears on the video monitor. Use of a 50X objective with C mount video camera coupling has been found acceptable for most fiber types. Using correctly calibrated image analysis software and a digital image capture board digitally capture the cross-sectional image. Using a mouse or stylus trace around the captured cross-sectional images. Use the image analysis software to store the resultant cross-sectional areas. If there are not sufficient fibers on the slide to provide 100 of each type, prepare another slide as described above using another tuft of fibers. Continue to trace and count on the new slide until 100 fibers of each type have been tallied. Cal-

culate the mean cross-sectional area automatically using the statistical functions of the digital image analysis software. Final values should be in μm².

14.3.2 Fibers with Circular Cross-Sections: Prepare a slide as described in 14.1.2. Be sure to make measurements on the same day that the slide was prepared. Position the slide in the microprojector or microscope so that all areas of the slide can be reached.

14.3.2.1 Measurement with Wedge Scale and Microprojector: Bring each individual fiber being measured into sharp focus on the wedge scale. Adjust the position of the scale until the fiber image is projected on the wedge with a fine line and mark on the wedge the point that corresponds to the width of the fiber midway of its length. Traverse the slide and measure successive fibers of each type following a planned course. Measure fibers only when their midpoint falls within the 10-cm circle central located in the field. Exclude from measurement those fibers that cross another fiber at the point of measurement and those that are shorter than 150 μm. A minimum of 100 fibers of each type present should be measured. Calculate the mean cross-sectional area of each fiber type. Final values should be in μm² (see 17.15). Considerable variation can occur in the average diameter of hair and wool fibers. Thus, for accurate results on

any specific sample, the fiber diameters must be measured. If, however, maximum accuracy is not required, the diameters given in Tables III and IV may be used.

14.3.2.2 Measurement with Digital Image Analysis Software: Using a correctly calibrated image analysis system measure the diameter of the individual fibers in question.

14.4 Calculations. Calculate the content of each fiber as percent by weight using equation 1 if 14.3.1 was used to determine average area of fiber cross-section images, and equation 2 if section 14.3.2 was used to determine fiber diameters (see 17.16).

$$X_i = \frac{N_i \times A_i \times S_i}{\Sigma(N \times A \times S)} \quad (1)$$

$$X_i = \frac{N_i \times D_i^2 \pi/4 \times S_i}{\Sigma(N \times D_i^2 \pi/4 \times S)} \quad (2)$$

where:

- X_i is content of fiber i , percent (by weight)
- N_i is relative number of fibers of type i
- A_i is average area of fiber images of fiber i
- D_i^2 is the mean of diameter squared of fibers of type i
- $D_i^2 \pi/4$ is the mean cross-sectional area of round cross-section fibers of type i
- S_i is specific gravity of type i fiber

Table III—Comparative Scale for Fineness of Various Textile Fibers in Micrometers (μm)

IWTO Super Fine Wools Grades			
'X' Value	Average Fineness μ	'X' Value	Average Fineness μ
Super 80's	19.5 ± 0.25	Super 150's	16.0 ± 0.25
Super 90's	19.0 ± 0.25	Super 160's	15.5 ± 0.25
Super 100's	18.5 ± 0.25	Super 170's	15.0 ± 0.25
Super 110's	18.0 ± 0.25	Super 180's	14.5 ± 0.25
Super 120's	17.5 ± 0.25	Super 190's	14.0 ± 0.25
Super 130's	17.0 ± 0.25	Super 200's	13.5 ± 0.25
Super 140's	16.5 ± 0.25	Super 210's	13.0 ± 0.25

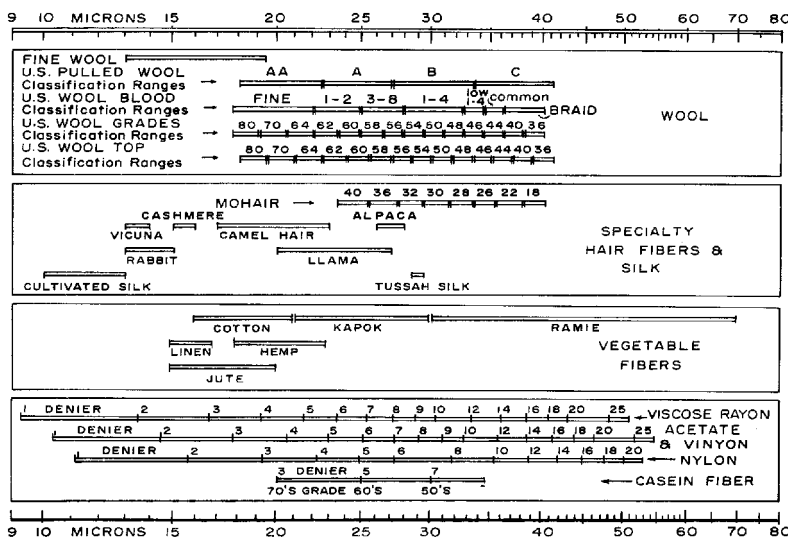

Table IV—Fineness Ranges and Fiber Diameters of Various Textile Fibers^a in Micrometers (μm)

U.S. Wool Classification					
Wool Grades			Wool Top Grades		Pulled Wool
Numerical System	Average Diameter	Blood System ^c	Numerical System	Average Diameter ^d	Grades
80s	17.7-19.1	Fine	80s	18.1-19.5	AA
70s	19.2-20.5	Fine	70s	19.6-21.0	AA
64s	20.6-22.0	Fine	64s	21.1-22.5	AA
62s	22.1-23.4	½	62s	22.6-24.0	A
60s	23.5-24.9	½	60s	24.1-25.5	A
58s	25.0-26.4	¾	58s	25.6-27.0	A
56s	26.5-27.8	¾	56s	27.1-28.5	B
54s	27.9-29.3	¾	54s	28.6-30.0	B
50s	29.4-30.9	¾	50s	30.1-31.7	B
48s	31.0-32.6	¾	48s	31.8-33.4	B
46s	32.7-34.3	Low ¾	46s	33.5-35.1	C
44s	34.4-36.1	Common	44s	35.2-37.0	C
40s	36.2-38.0	Braid	40s	37.1-38.9	C
36s	38.1-40.2	Braid	36s	39.0-41.2	C

Hair Fibers and Silk					
Mohair (1)		Miscellaneous Hair Fibers (1)		Silk (1)	
Grade	Fineness Range	Fiber	Average Fineness	Fiber	Average Fineness
40s	23.55-25.54	Vicuna	13.0-14.0	Cultivated silk	10.0-13.0
36s	25.55-27.54	Cashmere	14.0-19.0	Tussah silk	28.5
32s	27.55-29.54	Camel hair	17.0-23.0		
30s	29.55-31.54	Alpaca	26.0-28.0		
28s	31.55-33.54	Llama	20.0-27.0		
26s	33.55-35.54				
22s	35.55-38.04				
18s	38.05-40.54				

Vegetable Fiber (1)		Glass Fiber (2)			
Fiber	Average Fineness	Filament Diameter Designation	Theoretical Diameter	Staple Fiber Diameter Designation	Average Diameter
Cotton	16.0-21.0	D	5.3	E	7.1
Flax (linen)	15.0-17.0	E	7.4	G	9.7
Jute	15.0-20.0	G	9.0	J	11.4
Hemp	18.0-23.0				
Kapok	21.0-30.0				
Ramie	25.0-30.0				

Theoretical Fiber Diameter ^d					
Rayon (3), Acetate (3), Nylon (4), and Vinyon (3)				Casein Fiber (5)	
Filament Denier	Viscose Rayon	Acetate and Vinyon	Nylon	Grade	Fiber Diameter
1	9.6	10.3	11.1	70s	3
2	13.6	14.5	15.7	60s	5
3	16.7	17.8	19.3	50s	7
4	19.3	20.6	22.3		
5	21.6	23.0	24.9		
6	23.6	25.2	27.3		
7	25.5	27.3	29.5		
8	27.3	29.1	31.5		
9	28.9	30.9	33.4		
10	30.5	32.6	35.2		
12	33.4	35.7	38.5		
14	36.1	38.5	41.7		
16	38.6	41.2	44.5		
18	40.9	43.7	47.3		
20	43.1	46.1	49.9		

^a Source of Data:

- (1) Werner von Bergen and W. Krauss, *Textile Fiber Atlas*, Textile Book Publishers Inc., New York NY (1949).
- (2) Owens-Corning Fiberglas Corp.
- (3) American Viscose Corp.
- (4) E. I. du Pont de Nemours and Co.
- (5) Aralac Incorporated.

^c Trade application.

^d U.S. Standards, Federal Register, January 13, 1954; Specifications for Fineness of Wool Tops and Assignment of Grade (ASTM Designation: D 3992).

$\Sigma(N_i \times A_i \times S_i)$ is sum of the respective $N \times A \times S$ products for each fiber type in the blend

$\Sigma(N \times D_i^2 \pi/4 \times S)$ is sum of the respective $N \times D_i^2 \pi/4 \times S$ products for each fiber type in the blend

See Table V for specific gravity values.

15. Report

15.1 Report the percentage fiber content by weight of the sample analyzed. State if nonfibrous content has been removed or if results are based on other than oven-dry weights.

16. Precision and Bias

16.1 A chemical separation interlaboratory test was conducted using a PET/Wool intimate blend fabric with a nominal fiber content of 55% PET/45% Wool according to the fabric manufacturer, with results as noted in Tables VI and VII.

16.1.1 Between Laboratories

Standard Deviation = $\sqrt{0.6305}$ = 0.7940% polyester
 Precision: $\pm t.975(6df) \times S = 2.45 \times 0.7940\% = \pm 1.9454\%$ polyester

16.1.2 Between Operators within Laboratories.

Standard deviation = $\sqrt{0.0655}$ = 0.2559% polyester
 Precision: $\pm t.975(6df) \times S = 2.45 \times 0.2559\% = \pm 0.627\%$ polyester

16.2 *Interpretation.* The above statistics apply to the PET/Wool fabric tested which may represent a best case scenario for the determination of fiber content by chemical separation. Additional studies are underway in conjunction with Committee RA102, Statistics Advisory, involving different blend levels.

Table V

Fiber	Specific Gravity
Acetate	1.31
Acrylic	1.16-1.22
Cotton	1.55
Hair	1.32
Hemp	1.48
Linen	1.50
Modacrylic	1.28-1.38
Nylon	1.14
Olefin	0.93
Polyester	1.23-1.40
Ramie	1.51
Rayon	1.52
Silk	1.25
Spandex	1.0-1.2
Wool	1.31

In the case of a fiber with a range of values, knowledge of the specific type in the generic class may permit the selection of a precise specific gravity; or the density of a fiber may be determined using the procedure described in AATCC Test Method 20, Section 9.6.

Table VI—Nested Factorial Design (Polyester %)

Laboratory Operator	A		B		C		D		E	
	1	2	3	4	5	6	7	8	9	10
	58.00	57.57	58.60	58.00	57.95	58.27	58.35	59.88	58.30	57.78
	58.09	57.65	58.00	57.70						
	58.04	57.60								
Totals	174.13	172.82	116.60	115.70	57.95	58.27	58.35	59.88	58.30	57.78

Table VII—ANOVA

	Degrees of Freedom (df)	Sum of Squares	Mean Square	F Ratio
Between Laboratories	4	2.5221	0.6305	2.161
Between Operators within Laboratories	5	0.3275	0.0655	0.224
Residual (or error)	6	1.7501	0.2917	—
Totals	15	4.5997		

16.3 *Bias*. The quantitative fiber analysis can only be defined in terms of a test method. There is no independent method for determining the true value. As a means of estimating this property, the method has no known bias.

17. Notes

17.1 Applicable only to Nylon 6 and Nylon 6,6.

17.2 A projection microscope may be obtained from Kenneth A. Dawson Co., 106 Concord Ave., Belmont MA 02178; tel: 800/362-6795; or Unitron Instrument Co., 66 Needham St., Newton Highland MA 02161.

17.3 A Swiss Fiber Cutting Device is available from Harold Wolf, Clifton NJ. An FRL Fiber Cutter is available from Albany International Research Co., 777 West St., Mansfield MA 02048-9114; tel: 508/339-7300. Razor blades for the FRL Fiber Cutter are available from American Safety Razor Co., Industrial Products Div., Razor Blade Lane, Verona VA 24482-0979; tel: 800/336-4061; fax: 703/248-7122.

17.4 Wedge Scales may be obtained from E. J. Powers Press, 201 South St., Boston MA 02111; and Essex Ruling and Printing Co., Lawrence MA 01840.

17.5 Since sodium hypochlorite solutions lose strength on standing, it is recommended that they be standardized frequently. The following is a suitable method for determining the available chlorine content of such solutions: Dilute a 10 mL aliquot of the solution to be tested to 250 mL with water in a volumetric flask. Pipette 25 mL from the volumetric flask to an Erlenmeyer flask; add 3-5 mL of a 10% solution of potassium iodide (KI) and then add 2-3 mL acetic acid (CH₃COOH). Mix well and titrate with 0.1N sodium thiosulfate (Na₂S₂O₃) until the yellow color of the iodine is nearly destroyed. Add 5 mL of a starch indicator solution and titrate until the blue color entirely disappears. Calculate the percentage of available chlorine by weight as follows:

$$\text{Available Chlorine, \%} = 3.5A/B$$

where:

A = mL of 0.1N sodium thiosulfate used
B = g of 10 mL aliquot taken

17.6 Exception: when the pattern is smaller than 15 × 15 cm, a sufficient number of complete patterns should be taken to be equivalent to not less than 225 cm².

17.7 Whenever there is any doubt about the effectiveness of a given method in dissolving a specific fiber, or whenever there is an application of a method to a new type of fiber, one should always examine the residue in the filtering crucible after weighing. This precaution should always be taken when a fiber blend consists of (1) one predominate fiber with one (or more) minor components; or (2) one very minor fiber with one (or more) major components.

17.8 If a mechanical shaking machine is available, the flask may be shaken on it continuously for 30 min.

17.9 Cotton is not completely insoluble in H₂SO₄ (59.5%). Furthermore, a small amount of rayon remains undissolved in this solvent. In the analysis of cotton/rayon blends, inter-laboratory tests indicate that to allow for the above bias, the composition of the specimen should be calculated as follows:

$$\text{Corrected cotton, \%} = \frac{100 aJ}{F} - 1.6$$

where:

for raw cotton, a is 1.062
for bleached cotton, a is 1.046
J is the oven-dry residue weight
F is the oven-dry weight of clean fiber before treatment.

Corrected Regenerated Cellulose Rayon,

$$\% = 100 - \text{corrected cotton percent.}$$

17.10 Extreme care must be taken to control both time of exposure to the reagent and the temperature of treatment. If either is insufficient, the desired fiber or fibers, will not be completely dissolved. If either becomes excessive, it will cause attack of other fibers.

17.11 A mechanical shaking machine may be used for this purpose.

17.12 For fancy woven fabrics, use all the yarns in one or more complete patterns or a representative fraction, if the pattern is large.

17.13 Linen fibers may be present in the fabric or yarn in the form of fiber bundles. Most bundles are reduced to single fibers during the preparation of the fiber suspension. If, however, some bundles do appear on the slide, an attempt should be made to count each of the individual fibers in the bundle.

17.14 A regular microscope may be used for the fiber counting and, if a suitable calibrating device is available, it may also be used for measuring fiber diameters.

17.15 For further information on marking cell numbers on a wedge scale, and for examples of calculations of how to determine the average fiber diameter using cell numbers, see ASTM D 2130, Method of Test for Diameter of Wool and Other Animal Fibers by Microprojection.

17.16 One is cautioned not to mix units; e.g., if some fiber diameters have been determined in μm, then all diameters must be in μm. For ease of calculation, the terms D_i² and D² may be used in place of D_i² π/4 and D² π/4 respectively. If this is done one cannot use both cross-sectional areas and squared diameters in the same equation.

17.17 Available from Publications Office, ACGIH, Kemper Woods Center, 1330 Kemper Meadow Dr., Cincinnati OH 45240; tel: 513/742-2020.

17.18 Sulfuric acid (70%) is available from Fisher Scientific Co. at its various locations.

17.19 Any extractor capable of heating the sample in the solvent up to 150°C while pressurizing up to 2000 may be used. Solvent in use must have an auto ignition of higher than 200°C. The accelerated solvent extractor (ASE) manufactured by Dionex Corp. has been found to be an acceptable alternative to Soxhlet extractor.

18. References

- 18.1 ASTM D 276, Standard Test Methods for Identification of Fibers in Textiles.
- 18.2 ASTM D 629, Standard Test Methods for Quantitative Analysis of Textiles.
- 18.3 ASTM D 1776, Standard Practice for Conditioning and Testing Textiles.
- 18.4 ASTM D 1909, Standard Table of Commercial Moisture Regains for Textile Fibers.
- 18.5 ASTM D 2130, Method of Test for Diameter of Wool and Other Animal Fibers by Microprojection.
- 18.6 ASTM D 4920, Standard Terminology Relating to Moisture in Textiles.
- 18.7 ASTM Methods are available from ASTM, 100 Barr Harbor Dr., West Conshohocken PA 19428; tel: 610/832-9500; fax: 610/832-9555.

Water Repellency: Spray Test

Developed in 1941 by AATCC Committee RA63; revised 1952, 1996, 2001, 2005; reaffirmed 1943, 1961, 1964, 1967, 1971, 1974, 1977, 1980, 1985, 1989; editorially revised 1987. Technically equivalent to ISO 4920.

1. Purpose and Scope

1.1 This test method is applicable to any textile fabric, which may or may not have been given a water-repellent finish. It measures the resistance of fabrics to wetting by water. It is especially suitable for measuring the water-repellent efficacy of finishes applied to fabrics.

1.2 The results obtained with this test method depend on the resistance to wetting or water repellency of the fibers, yarns and finishes on the fabric, and upon the construction of the fabric.

2. Principle

2.1 Water sprayed against the taut surface of a test specimen under controlled conditions produces a wetted pattern whose size depends on the repellency of the fabric. Evaluation is accomplished by comparing the wetted pattern with pictures on a standard chart.

3. Terminology

3.1 **water repellency**, *n.*—*in textiles*, the characteristic of a fiber, yarn or fabric to resist wetting.

3.2 **face**, *n.*—*in textiles*, the side of a fabric that is intended to be the outer visible surface in an end product.

4. Safety Precautions

NOTE: These safety precautions are for information purposes only. The precautions are ancillary to the testing procedures and are not intended to be all inclusive. It is the user's responsibility to use safe and proper techniques in handling materials in this test method. Manufacturers MUST be consulted for specific details such as material safety data and other manufacturer's recommendations. All OSHA standards and rules must also be consulted and followed.

4.1 Good laboratory practices should be followed. Wear safety glasses in all laboratory areas.

5. Uses and Limitations

5.1 The portability and simplicity of the instrument, and the shortness and simplicity of the test procedure, make this method of test especially suitable for

screening finishes. It is not intended, however, for use in predicting the probable rain penetration resistance of fabrics, since it does not measure penetration of water through the fabric. For testing rain penetration, AATCC Method 35, Water Resistance: Rain Test, should be used.

6. Apparatus and Materials

6.1 AATCC Spray Tester (see 11.1, Figs. 1, 2, 2A and 3).

6.2 Graduated cylinder, 250 mL.

6.3 Water, distilled.

6.4 Stopwatch (see 8.3)

7. Test Specimens

7.1 Three test specimens 180.0 × 180.0 mm (7.0 × 7.0 in.) are needed and should be conditioned at 65 ± 2% relative humidity and 21 ± 1°C (70 ± 2°F) for a minimum of 4 h before testing.

7.2 Where possible, each specimen should contain different groups of lengthwise and widthwise yarns.

8. Procedure

8.1 Calibrate the apparatus by pouring 250 mL of distilled water at 27 ± 1°C (80 ± 2°F) into the funnel of the tester and measure the time required for the funnel to empty.

8.1.1 The spray time must be between 25-30 s, otherwise the nozzle should be checked to see if the holes are enlarged or blocked.

8.2 Fasten the test specimen securely in the 152.4 mm (6.0 in.) diameter hoop so that the face of the fabric specimen will be exposed to the water spray. The surface of the specimen should be smooth and without wrinkles.

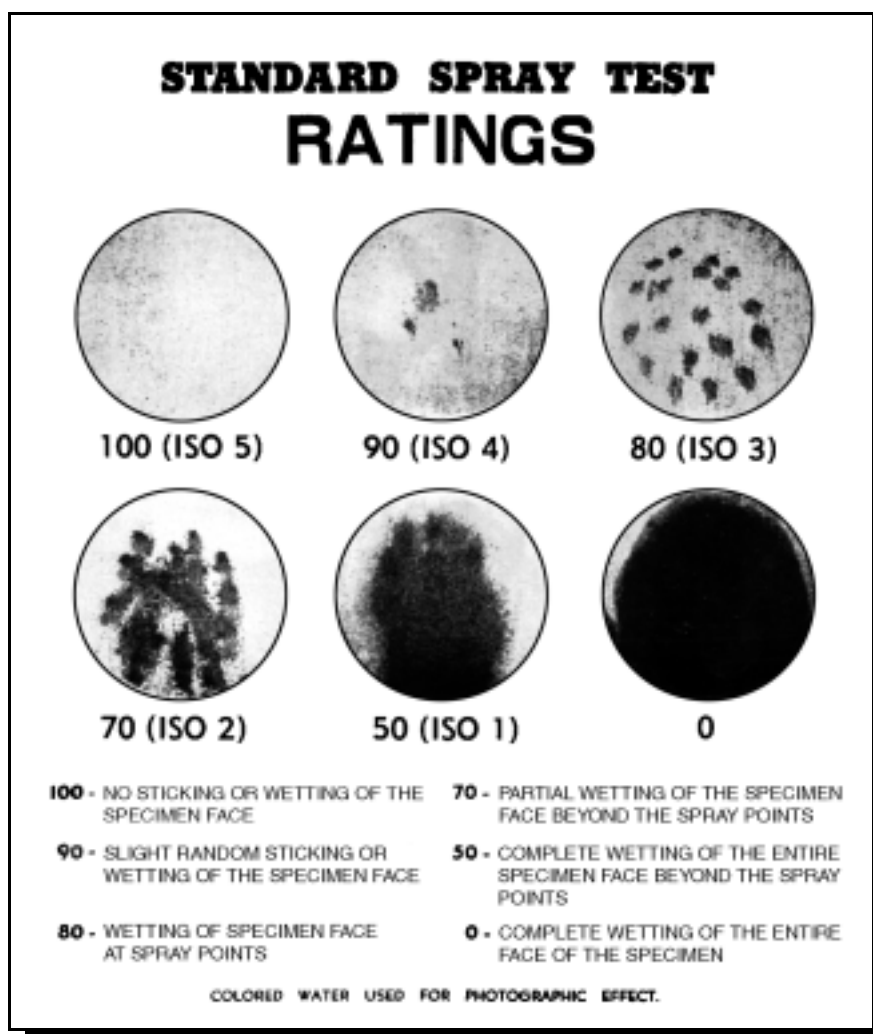

Fig. 1—Spray test rating chart.

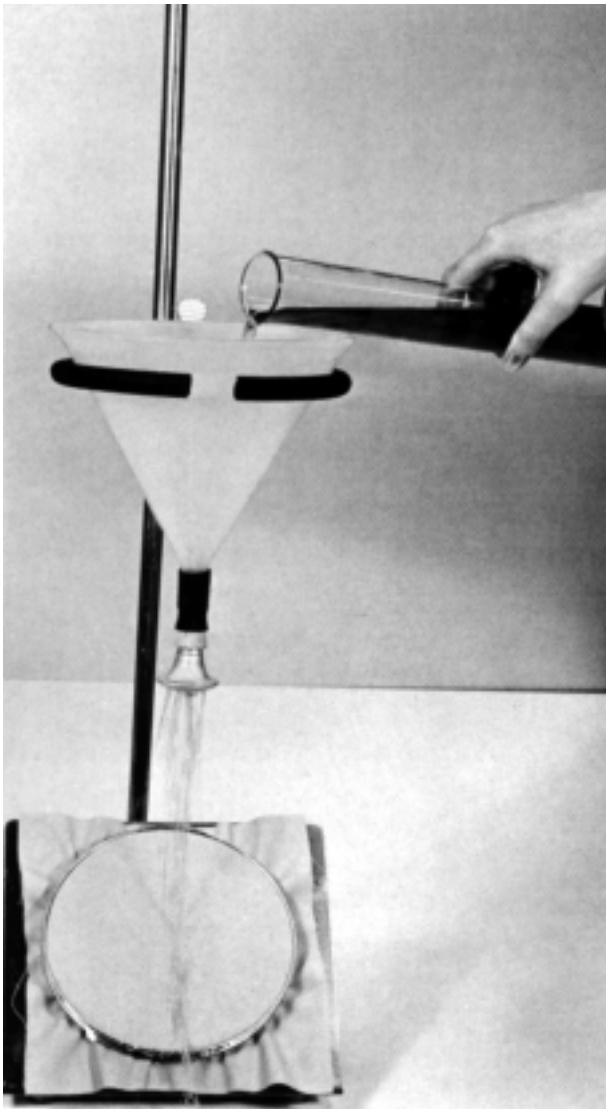

Fig. 2—AATCC spray tester.

8.3 Place the hoop on the stand of the tester with the fabric uppermost in such a position that the center of the spray pattern coincides with the center of the hoop (see Fig. 2A).

8.3.1 In the case of twills, gabardines, piques or fabrics with similar ribbed construction, place the hoop on the stand in such a way that the fabric is oriented in the same direction as it will be used in the end product.

8.4 Pour 250 mL of distilled water at $27 \pm 1^\circ\text{C}$ ($80 \pm 2^\circ\text{F}$) into the funnel of the tester and allow it to spray onto the test specimen for 25-30 s.

8.4.1 Avoid touching the funnel with the graduated cylinder while pouring the distilled water. Movement of the funnel will alter the spray disposition on the specimen.

8.5 Take the hoop by the bottom edge and tap the opposite edge firmly once against a solid object with the fabric facing the object, then rotate the hoop 180° and tap once more on the point

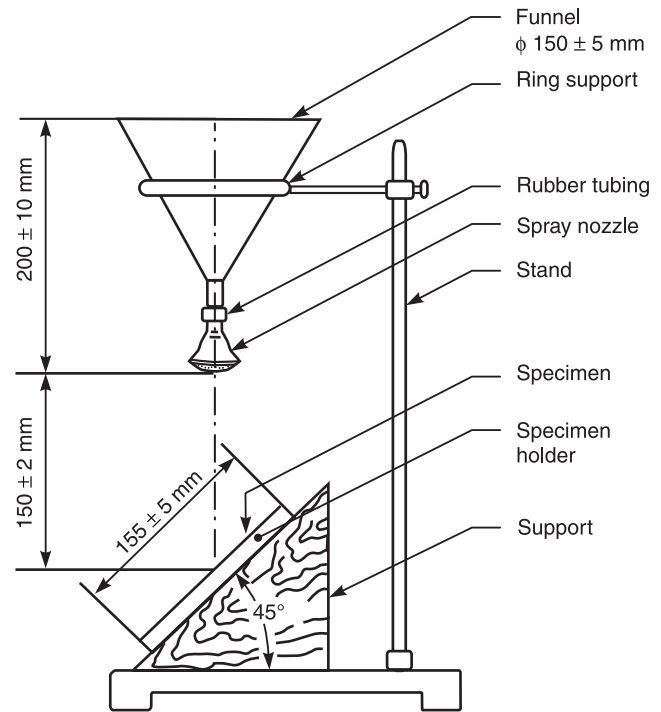

Fig. 2A—Details of AATCC spray tester.

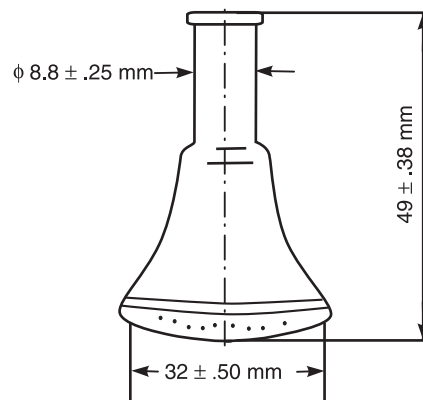
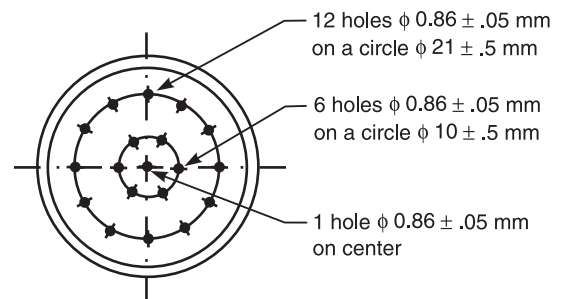

Fig. 3—Nozzle for spray tester.

previously held.

8.6 Repeat steps 8.2 through 8.5 for all three specimens.

9. Evaluation and Report

9.1 Immediately after tapping, compare the wet or spotted pattern with the rating chart (see Fig. 1). Rate the face of the specimen. Each test specimen is assigned a rating corresponding to the nearest level on the rating chart.

9.1.1 Intermediate ratings can be used for ratings of 50 or higher (95, 85, 75, 60) (see flow chart in Appendix A).

9.1.2 In rating loosely woven or porous fabrics, such as voile, any passage of water through the openings of the fabric is disregarded.

9.2 Report the individual rating results for each test specimen. Do not average the results.

10. Precision and Bias

10.1 *Precision.* Precision of this test method is based on interlaboratory tests conducted in 1994, using six laboratories, three fabrics, two operators per laboratory and three determinations per fabric. Separate tests were run on two days. The data sets from each lab were combined for analysis, which required averaging the individual ratings. There were no significant differences found between days.

10.1.1 The Spray Rating Scale is discrete and discontinuous, but results are based on averages which tend to normality. Also, ratings are assigned against developed grade standards (photographs), rather than by arbitrary visual assign-

ment. For these reasons, RA63 has made a judgment that analysis of variance be used in determining the precision of this method, without correction for discontinuity.

10.1.2 The three fabrics used in this study cover a range of 100 to 80 Spray Rating. Obviously, this is a limited study upon which to base a statement of precision for the method. It is the best and only estimate of precision currently available. Users of the test method should be guided accordingly. In making fabric comparisons for Spray Rating, laboratories are encouraged to establish their levels by running fabrics of known performance prior to any test comparisons, and to bring the practice of the test method under statistical control.

10.1.3 Plant experience consistently has shown variation in spray ratings near a grade of 100 to be quite small, with increasing variation as the grade goes lower. This has been verified again, in this limited study. For this reason, critical difference tables are shown for two ranges.

10.1.4 Single fabric precision parameters for two fabric levels are given in Tables I and II.

10.2 *Bias.* This test method has no known bias. There is no referee method by which to determine the true value of Spray Rating and to find any existing bias in this methodology.

11. Notes

11.1 The AATCC Spray Test Unit consisting of hoop, nozzle, funnel, stand and Spray Test Rating Chart is available from AATCC,

**Table I—Spray Rating Range—80
Components of Variance**

$$V_{lab} = 17.2222$$

$$V_{op} = 9.2593$$

$$V_{err} = 9.3750$$

Single Fabric Precision Parameters

N	Single Operator	Within Laboratory	Between Laboratory
1	8.5	12.0	16.6
2	6.0	10.4	15.5
3	4.9	9.8	15.1
4	4.2	9.4	14.9
5	3.8	9.2	14.8

**Table II—Spray Rating Range—100
Components of Variance**

$$V_{lab} = 0$$

$$V_{op} = 0.6945$$

$$V_{err} = 4.4841$$

Single Fabric Precision Parameters

N	Single Operator	Within Laboratory	Between Laboratory
1	5.9	6.3	6.3
2	4.2	4.8	4.8
3	3.4	4.1	4.1
4	2.9	3.7	3.7
5	2.6	3.5	3.5

P.O. Box 12215, Research Triangle Park NC 27709; tel: 919/549-8141; fax: 919/ 549-8933; e-mail: orders@aatcc.org; SDL Atlas L.L.C., 1813A Associate Lane, Charlotte NC 28217; tel: 704/329-0911; fax: 704/329-0914; e-mail: info@sdlatlas.com; or Advanced Testing Instruments Corp., 316D Business Pkwy., Greer SC 29651-7119; tel: 864/989-0566; fax: 864/989-0567; e-mail: aticorporation@cs.com.

Appendix A Flow Chart of Evaluation and Report

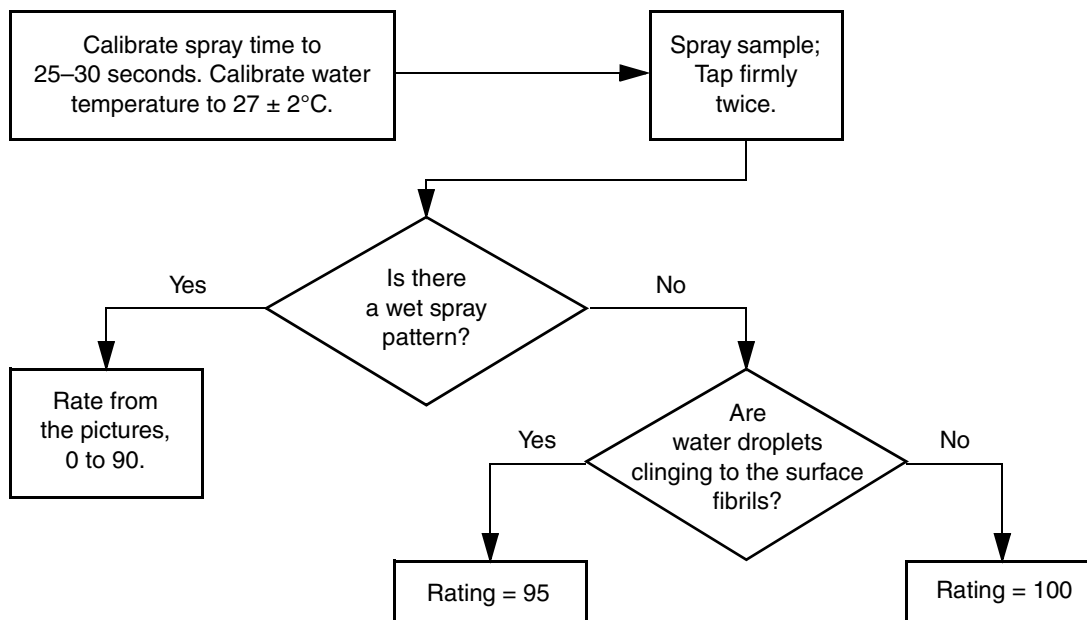

Colorfastness to Burnt Gas Fumes

Developed in 1941 by AATCC Committee RA33; revised 1946, 1952, 1957, 1962, 1972, 2005; reaffirmed 1971, 1975, 1983; 1989; editorially revised 1981, 1983, 1985, 1995, 1996, 1997; editorially revised and reaffirmed 1988, 1994, 1999, 2004. Technically equivalent to ISO 105-G02.

1. Purpose and Scope

1.1 This test method is intended for assessing the resistance of the color of textiles of all kinds and in all forms when exposed to atmospheric oxides of nitrogen as derived from the combustion of natural gas. Exceptions are noted in 11.7.1.

1.2 This test method may be used for rating colorfastness of dyes by applying the dye to textiles by a specified procedure and at a specified depth of color and testing the dyed textiles.

2. Principle

2.1 A specimen of the textile and the test control fabric are exposed simultaneously to oxides of nitrogen from burnt gas fumes until the control shows a change in color corresponding to that of the standard of fading. The change in color of the specimen is assessed with the standard gray scale for assessing change in color. If no color change is observed in the specimen after one exposure period or cycle, exposure may be continued, for either a specified number of periods or for the number of periods required to produce a specified amount of color change in the specimen.

3. Terminology

3.1 **burnt gas fumes**, n.—atmospheric oxides of nitrogen as derived from the combustion of illuminating or heating gas.

3.2 **colorfastness**, n.—the resistance of a material to change in any of its color characteristics, to transfer of its colorant(s) to adjacent materials, or both, as a result of the exposure of the material to any environment that might be encountered during the processing, testing, storage or use of the material.

4. Safety Precautions

NOTE: These safety precautions are for information purposes only. The precautions are ancillary to the testing procedure

and are not intended to be all inclusive. It is the user's responsibility to use safe and proper techniques in handling materials in this test method. Manufacturers MUST be consulted for specific details such as material safety data sheets and other manufacturer's recommendations. All OSHA standards and rules must also be consulted and followed.

4.1 Good laboratory practices should be followed. Wear safety glasses in all laboratory areas.

4.2 All chemicals should be handled with care.

4.3 Stoddard solvent is a combustible liquid and presents a moderate hazard. It should not be used near an open flame, and fabric saturated with this solvent should be dried in an adequately ventilated laboratory hood. Use chemical goggles or face shield, impervious gloves and an impervious apron when handling Stoddard solvent.

4.4 Perchloroethylene is toxic by inhalation, by repeated contact with skin and by ingestion; it MUST be used only in a well vented atmosphere. Toxicology studies with laboratory animals have shown evidence of cancer in rats and mice exposed to perchloroethylene vapors at 100-400 ppm concentrations for prolonged times. Fabric saturated with this solvent should be dried in an adequately ventilated laboratory hood. Use chemical goggles or face shield, impervious gloves and an impervious apron when handling perchloroethylene.

4.5 An eyewash/safety shower should be located nearby and an organic vapor respirator should be readily available for emergency use.

4.6 Exposure to chemicals used in this procedure must be controlled at or below levels set by governmental authorities (e.g., Occupational Safety and Health Administration's [OSHA] permissible exposure limits [PEL] as found in 29 CFR 1910.1000 of January 1, 1989). In addition, the American Conference of Governmental Industrial Hygienists (ACGIH) Threshold Limit Values (TLVs) comprised of time weighted averages (TLV-TWA), short term exposure limits (TLV-STEL) and ceiling limits (TLV-C) are recommended as a general guide for air contaminant exposure which should be met (see 11.10).

5. Apparatus, Materials and Reagents

5.1 Exposure chamber (see 11.1).

5.2 Control Sample No. 1 (see 11.2).

5.3 Standard of Fading (see 11.2).

5.4 Gray Scale for Color Change (see 11.9).

5.5 Natural gas (see 11.5).

5.6 Urea solution (see 11.9).

5.7 Mineral spirits.

5.8 Perchloroethylene.

5.9 Trichloroethylene.

5.10 1993 AATCC Standard Reference Detergent WOB.

6. Test Specimens

6.1 Use test specimens that measure approximately 5.0 × 10.0 cm. If pressing is necessary to remove wrinkles, iron the specimens between two layers of closely woven cotton cloth or press them with a steam press (see 11.3).

6.1.1 For fastness to oxides of nitrogen in storage or use, test a specimen of the original fabric.

6.1.2 For fastness to oxides of nitrogen after drycleaning, immerse one specimen in cold mineral spirits for 10 min, then squeeze the solvent out and dry the specimen in air. One specimen is immersed in cold perchloroethylene for 10 min, squeezed and allowed to dry in the air. Trichloroethylene may be substituted for perchloroethylene. Prepare a drycleaned only specimen for comparison with the tested drycleaned specimen.

6.1.3 For fastness to oxides of nitrogen after washing (see 11.4), unless a specific wash test is specified, wash the test specimen in a detergent solution containing 5 g of 1993 AATCC Standard Reference Detergent WOB (see 11.8) per liter of water of approximately zero hardness for 10 min at 41 ± 3°C, rinse it in warm water and dry it in air. Prepare a washed only specimen to compare with the tested washed specimen.

7. Procedure

7.1 Suspend the test specimens and a piece of the control sample freely in the test chamber so that they are not in contact with each other and do not come into direct contact with any hot metallic surface. Light the gas burner and adjust the flame and ventilating equipment so that the temperature in the chamber does not exceed 60°C (see 11.6 and 11.7). Leave the specimens to remain in the chamber until the control sample changes color to correspond to the color of the Standard of Fading when compared in daylight (ranging from average to slightly bluish north sky light) or equivalent artificial illumination.

7.2 Then remove the test specimens from the test chamber and immediately assess the change in color of each by use of the Gray Scale for Color Change.

7.3 Specimens exposed to oxides of nitrogen may continue to change color after removal from the test chamber. Optionally, another or more detailed visual or instrumental examination may be done. If this is to be done, without delay, plunge the test and control specimens and pieces of the original test and control fabric into buffered urea solution (see 11.9) for 5 min. Then squeeze out the specimens and pieces and thoroughly rinse them. Dry the specimens in air at a temperature not above 60°C.

7.4 After the first cycle, any specimens which do not show a color change and which are not treated with the buffered urea solution may be returned to the test chamber along with a fresh piece of the test control and the test continued until the second test control shows a change in color corresponding to that of the Standard of Fading.

7.5 Cycles may be repeated for either a specified number of cycles or until the specimens show a specified amount of color change.

8. Evaluation

8.1 At the end of each cycle immediately compare those specimens which are removed from the exposure chamber with the preserved originals from which they were drawn.

8.2 Rate the effect on color of test specimens after any specified number of cycles by reference to the Gray Scale for Color Change, and report the number of cycles run (see 11.11).

Grade 5—negligible or no change as shown in Gray Scale Step 5.

Grade 4.5—change in color equivalent to Gray Scale Step 4-5.

Grade 4—change in color equivalent to Gray Scale Step 4.

Grade 3.5—change in color equivalent to Gray Scale Step 3-4.

Grade 3—change in color equivalent to Gray Scale Step 3.

Grade 2.5—change in color equivalent to Gray Scale Step 2-3.

Grade 2—change in color equivalent to Gray Scale Step 2.

Grade 1.5—change in color equivalent to Gray Scale Step 1-2.

Grade 1—change in color equivalent to Gray Scale Step 1.

9. Report

9.1 Report the grade for each specimen and the number of cycles, to which it was exposed. Report the average temperature employed and, if humidity was increased, report the method used.

10. Precision and Bias

10.1 *Precision.* Precision for this test method has not been established. Until a precision statement is generated for this test method, use standard statistical techniques in making any comparisons of test results for either *within-laboratory* or *between-laboratory* averages.

10.2 *Bias.* Burnt gas fumes can be defined only in terms of a test method. There is no independent method for determining the true value. As a means of estimating this property, the method has no known bias.

11. Notes

11.1 Exposure Chamber.

11.1.1 The exposure chamber may be of variable construction but must provide an enclosure in which test specimens can be exposed in an atmosphere of air which has passed over and contains the byproducts of combustion from a lighted gas burner. The apparatus should be equipped with a suitable means of supporting the test specimens so that there is a free circulation of the atmosphere around the specimens and so that only a minimum amount of the specimen at the point of its suspension is in direct contact with any hot metallic surface. Either a motor driven fan to move the air around in the test chamber or a motor driven rotating specimen rack should be used in order to insure as nearly as is possible that all specimens are exposed to the same conditions of gas concentration, temperature and humidity. Adjustable vents or dampers in the top of the unit together with the height of the flame of the gas burner are used to regulate the temperature of the exposure chamber, but temperature and humidity will vary with that of the room in which the exposure chamber is being operated.

11.1.2 Several forms of suitable apparatus are illustrated in the *American Dyestuff Reporter*, July 22, 1940, pages 368-9. Blueprints of a suitable apparatus can be purchased from AATCC, P.O. Box 12215, Research Triangle Park NC 27709; tel: 919/549-8141; fax: 919/549-8933; e-mail: orders@aatcc.org.

11.2 Test Control and Standard of Fading.

11.2.1 The test control fabric is a dyeing of 0.4% C.I. Disperse Blue 3 on cellulose acetate satin. Celliton Blue FFRN is used since its fading characteristics are well known and other C.I. Disperse Blue 3 dyes tend to exhibit different fading characteristics.

11.2.2 Pieces of the original lot of control fabric were hung in air in three separate places in southern New Jersey for six months. It was assumed that the atmosphere in these places contained an average content of oxides of nitrogen. At the end of the exposure period, samples from the three locations were assembled and compared with the original material. All had changed about equally, being decidedly duller and redder than the original. The faded shade was then matched with vat dyes on cellulose acetate satin and this became the original standard of fading for that lot of control fabric. This produced a standard of fading which was more permanent than the exposed pieces of the control fabric which would have continued to change with even very small amounts of oxides of nitrogen.

11.2.3 Since different lots and sources of both the dyestuff and undyed fabric will produce variations in both the original shade and its fading rate, it is therefore necessary to accurately establish a new standard of fading for each dyed lot of control fabric so that comparable tests results can be obtained when using different lots of the control and their respective standards of fading. In conducting tests, only the standard of fading applicable to that lot of control fabric may be used.

11.2.4 The standard of fading for the original lot of control fabric was made with vat dyes on cellulose acetate satin. For subsequent lots of the control fabric it was found for the standard of fading that use of direct dyes on viscose satin provided a better shade match. The Standard of Fading is dyed with approximately the following formula: 0.300% C.I. Direct Blue 80 and 0.015% C.I. Direct Violet 47 based on the weight of the fabric.

11.2.5 Both the control fabric and the standard of fading must be kept in suitable containers or enclosures to protect them from possible exposure and color change to oxides of nitrogen and other contaminants which might be present in the atmosphere during transportation and storage.

11.2.6 The control fabric is also sensitive to other atmospheric contaminants such as ozone. Its fading rate will vary considerably at different humidities and temperatures and its use in natural or end-use testing as a measure of exposure to oxides of nitrogen is not recommended. The color change produced on the control will reflect the combined effects of the atmospheric contaminants present, and temperature-humidity variations; not just the effects of exposure to oxides of nitrogen.

11.2.7 A sealed unit of Test Control Fabric comprising 18.29 m of ribbon 5.08 cm wide with a specific lot number indicated and a specimen of the Standard of Fading for that lot of control fabric is available as Control Sample No. 1 from Testfabrics Inc., P.O. Box 26, 415 Delaware St., W. Pittston PA 18643; tel: 570/603-0432; fax: 570/603-0433; e-mail: testfabric@aol.com.

11.3 Heat by Ironing.

11.3.1 When an acetate fabric is pressed with an iron which is hot enough to remove all wrinkles, there is danger of sealing the surface of the fabric which would increase the resistance to gas fading. This technique is not conducive to accurate test results and should be avoided on fabrics of this type.

11.4 Drycleaning and Washing Test Specimens.

11.4.1 All the inhibitors available at present are soluble to some extent in water and therefore tend to be removed by washing. These inhibitors are in general not soluble in the ordinary drycleaning solvents, and fabrics treated with suitable inhibitors should withstand several drycleanings without losing their resistance to gas fading (if the drycleaning operation does not include spotting or sponging with water). The inhibitors also tend to lose their efficiency if the fabrics come into frequent contact with perspiration.

11.5 Gas.

11.5.1 Illuminating gas furnished by the gas companies in Massachusetts, Connecticut, Rhode Island, New York, New Jersey, Pennsylvania and Delaware has been used in

this work, including both natural and manufactured gas. The results were essentially the same in all cases. Any gas burner may be used, and either a luminous (yellow) or a blue-green flame is suitable, though the latter is to be preferred to avoid formation of soot. A wire screen placed between a red and a white heat will increase the percentage of oxides of nitrogen (the color-destroying gases) produced by the burning gas, and will thereby accelerate the fading of the samples. Brass, iron, monel metal and stainless steel screens give practically the same results. In cases of dispute or for referee testing compressed butane (c.p.) gas in cylinders shall be used.

11.6 Temperature for Testing.

11.6.1 Other conditions being equal, the fading of the specimens will vary according to the temperature in the exposure chamber, which in turn depends upon the amount of gas

consumed in a given period. Exposure for 8-12 h at 60°C may cause as much color destruction as exposure for 96 h at 21-27°C. Aside from this, the temperature may vary somewhat in different parts of the exposure chamber from time to time.

11.7 Humidity for Testing.

11.7.1 The fading of dyes by oxides of nitrogen on acetate, triacetate and polyester will occur at relatively low humidities as would be obtained in the conventional chamber at temperatures approaching 60°C. For other fibers such as nylon, rayon or cotton it is necessary to use high humidities to produce results which correlate with service performance. A suggested procedure for raising the level of humidity in the chamber is to place containers of water on the floor surface of the chamber. If the humidity is raised by this or any other procedure, this should be noted in the report of the test results.

11.8 Available from AATCC, P.O. Box 12215, Research Triangle Park NC 27709; tel: 919/549-8141; fax: 919/549-8933; e-mail: orders@aatcc.org.

11.9 Urea Solution.

11.9.1 10 g of urea ($\text{NH}_2\text{-CO-NH}_2$) per liter buffered to pH 7 by addition of 0.4 g of monosodium orthophosphate ($\text{NaH}_2\text{PO}_4 \cdot 2\text{H}_2\text{O}$) and 2.5 g of sodium phosphate dibasic, dodecahydrate ($\text{Na}_2\text{HPO}_4 \cdot 12\text{H}_2\text{O}$) and 0.1 g or less of an anionic surfactant.

11.10 Available from Publications Office, ACGIH, Kemper Woods Center, 1330 Kemper Meadow Dr., Cincinnati OH 45240; tel: 513/742-2020.

11.11 An automated electronic grading system may be used as long as the system has been demonstrated to provide results that are equal to and provide equal or better repeatability and reproducibility than an experienced grader performing visual evaluation.

Insects, Resistance of Textiles to

Developed in 1940 by AATCC Committee RA49; Jurisdiction transferred in 1994 to AATCC Committee RA31; revised 1949, 1952, 1963; reaffirmed 1956, 1971, 1974, 1977, 1980, 1989, 1999; editorially revised 1974, 1976, 1988, 1992; editorially revised and reaffirmed 1985, 1994, 2004. Related to ISO 3998.

1. Purpose and Scope

1.1 Biological test methods are given for evaluating the resistance of textiles that contain wool or other susceptible fibers to webbing clothes moths and to carpet beetles. The test methods described here are not concerned with the various procedures for treating textiles [e.g., dye-baths vs. padding application of moth-proofers] or with their subsequent handling, ageing, washing, etc. but only with the biological methods to be used to measure the resistance of the [treated or untreated] textiles to insect attack (see 15.1).

1.2 Two methods are provided for determining the extent of damage to test specimens. The *Excrement Weight Method* is used only for tests with carpet beetles. The *Fabric Weight Loss Method* is used for tests with webbing clothes moths and also may be used for tests with carpet beetles when preferred and when comparative tests with both insects are made (see Appendix D).

2. Principle

2.1 These methods measure quantitatively the amount of feeding on the test specimen by the specified number and type of insects for a prescribed time under controlled conditions of temperature and humidity.

3. Terminology

3.1 **insect resistance**, n.—*in textiles*, the capability to impede damage by insects.

4. Safety Precautions

NOTE: These safety precautions are for information purposes only. The precautions are ancillary to the testing procedures and are not intended to be all inclusive. It is the user's responsibility to use safe and proper techniques in handling materials in this test method. Manufacturers MUST be consulted for specific details such as material safety data sheets

and other manufacturer's recommendations. All OSHA standards and rules must be consulted and followed.

4.1 Insects should be handled by trained personnel.

4.2 Good laboratory practices should be followed. Wear safety glasses in all laboratory areas.

5. Apparatus and Materials

5.1 Test Cages.

5.1.1 The cage for conducting the tests may be any shallow glass or metal flat-bottomed container large enough to permit the test insects to be either in contact with or off the horizontally placed test specimen. It must be well ventilated and provided with a 60-mesh metal screen cover.

5.2 Test Insects.

5.2.1 **Black Carpet Beetle (*Attagenus megotoma* (F.))**—Larvae are used from cultures maintained as described in Appendix A. Larvae must be in the weight range of 6-7 mg each and of such size that they pass through a U.S. Standard Sieve Series No. 14 sieve and are retained on a No. 16 sieve as described in Appendix A, A10 and A11.

5.2.2 **Furniture Carpet Beetle (*Anthrenus flavipes* LeConte)**—Larvae from cultures maintained as described in Appendix C may be used as alternative test insects with the black carpet beetle. Larvae must be approximately nine weeks old when put on test as measured from the time of egg deposition. The feeding propensities of the two species are similar.

5.2.3 **Webbing Clothes Moth [*Tineola bisselliella* (Hum.)]**—Larvae are used from cultures maintained as described in Appendix B. Larvae must be 25-27 days old as measured from the date of egg deposition to the time they are put on test since older larvae may pupate during the test period.

5.2.4 **Other Species**—Other species of insect pests may be used for obtaining supplementary data insofar as the test methods herein described are applicable.

5.3 **AATCC Moth Test Cloth**—(see 15.2).

6. Test Specimens

6.1 At least four test specimens and four control specimens are required for the excrement weight method and at least eight of each for the fabric weight loss method. The specimens must be free of any solvents or carriers used in applica-

tion of chemical treatments and of any solvents or auxiliary agents used in subsequent durability testing.

6.2 **Fabrics**—Test specimens, each with an area of 12.9 cm² (2 in.²), are cut from widely spaced portions of the fabric.

6.3 **Yarns**—Test specimens of each yarn are prepared by uniformly winding one layer of yarn on a square or rectangular piece of glazed cardboard, glass or metal with an area of 12.9 cm² (2 in.²). The surface of the glazed cardboard, glass or metal must be substantially covered by the yarn.

6.4 **Carpets**—Test specimens, each with an area of 12.9 cm² (2 in.²), are cut from widely-spaced portions of the carpet. The edges of the specimens are secured by coating the backing yarns with cellulose nitrate dissolved in acetone (see 15.3). For the weight loss method, specimens are prepared by stapling pieces of yarn removed from the specimen to pieces of glazed paper, each having an area of 12.9 cm² (2 in.²) so that the surface is covered substantially by the yarn.

6.5 **Control Specimens for Insect Activity**—Control specimens of the standard control fabric (see 15.2), each having an area of 12.9 cm² (2 in.²), are exposed under the same conditions as the test specimens. If the fabric or yarn to be tested has been treated with some form of insecticide for the purpose of increasing its resistance to insect pests, specimens of the same fabric or yarn in the untreated condition should be exposed for comparison, if possible.

6.6 It is important that various lots of fabric for control specimens and lots of fabric and other materials used as rearing medium be thoroughly checked to determine their suitability prior to use.

7. Procedure: Excrement Weight Method (For Carpet Beetles)

7.1 **Preparation**—At least four test specimens and four control specimens are prepared in accordance with Section 6. Each test specimen and control specimen is freed of any loosely adhering dirt or dust (see 15.3) and placed face down in a separate test cage. Ten larvae as specified in 5.2.1 or 5.2.2 are placed on the top of each specimen, and the cage covered as specified in 5.1.

7.2 **Incubation**—The cages containing the test specimens and larvae are kept for 14 days at 27 ± 1°C (80 ± 2°F) and 55 ± 5% relative humidity. Light is excluded.

8. Evaluation: Excrement Weight Method

8.1 Insect Survival—Remove and record living and dead insects. Survival counts are made in all cases, since they are important in demonstrating the validity of the test larvae.

8.2 Extent of Damage—Damage to the test specimens is determined by the quantity of excrement deposited during the test period as follows:

8.2.1 Remove test specimen from test cage and, by alternately tapping and brushing, transfer all loose material, excrement, exuviae, etc., back into the test cage.

8.2.2 Transfer contents of test cage into a No. 3 Gooch crucible and, by repeated tapping of the crucible, the excrement is sifted through the perforations into one of a pair of matched watch glasses.

8.2.3 Weigh the excrement on an analytical balance sensitive to at least 0.2 mg. For the purpose of this test, all material that sifts through the perforations of the Gooch crucible is construed as excrement.

9. Classification: Excrement Weight Method

9.1 The report must include the following information for each test specimen of the treated sample and the untreated controls:

- (a) Weight of excrement in milligrams.
- (b) Number of larvae alive.

9.2 The test textile is considered satisfactorily resistant to carpet beetles if an average quantity of excrement of not over 5 mg per specimen is deposited, provided that no single specimen shows more than 6 mg of excrement and that under the same conditions the controls show an average quantity of excrement of not less than 15 mg per specimen.

9.3 The test is invalid if the quantity of excrement deposited on the control specimens averages less than 15 mg per specimen, or if less than 90% of the control larvae survive.

10. Procedure: Fabric Weight Loss Method (For Carpet Beetles and Clothes Moths)

10.1 Preparation—Two sets of at least eight test specimens each, one set from the material to be tested and the other from the standard control fabric (see 15.2), are prepared in accordance with Section 6. Four specimens of each set are used for feeding tests, and the other four as humidity controls.

10.2 Humidity Control Test—Four specimens from each set are exposed to the same test conditions as the specimens used for feeding tests except that no larvae are added. A change in weight of the humidity check specimens is due to

change in moisture content only and is used to correct the weights of the feeding test specimens. (This method of humidity correction cannot be relied upon to correct for wide variations in humidity during the observation period.)

10.3 First Weighing—The test specimens and humidity control specimens are freed of any loosely adhering dirt or dust and placed in the test cages under controlled humidity and temperature conditions (see 7.2) for at least 48 h before weighing. They are weighed under the same conditions as specified in 8.2.3. The order of weighing is alternated between test specimen and humidity control specimen, and the same order is followed at the second weighing (see 11.2.2).

10.4 Incubation—Ten larvae as specified in 5.2 are placed on each test specimen and the test containers covered as specified in 5.1. The test cages and humidity check cages are held for 14 days as specified in 7.2.

11. Evaluation: Fabric Weight Loss Method

11.1 Insect Survival—Remove and record living and dead insects as in 8.1.

11.2 Extent of Damage—Extent of damage to the test specimens by the loss of weight due to feeding of the larvae is determined as follows:

11.2.1 Brush the specimens to free them of all loose material such as excrement, webbing, cast skins, loose fibers, etc. Forceps are usually necessary to remove masses of webbing and excrement from clothes moth test specimens and containers.

11.2.2 Second Weighing—The cleaned test specimens and control specimens and the humidity check specimens are again weighed in accordance with 10.3, after the test specimens have been reconditioned at controlled temperature and humidity for at least 24 h after cleaning and removal of insects.

11.2.3 Loss of Weight—The loss of weight, in milligrams, due to feeding of the test larvae, as adjusted for humidity changes, is calculated as follows:

$$L = \frac{AC}{B} - D$$

where:

- L = adjusted loss of weight in milligrams due to insect feeding.
- A = average weight of the four test specimens before testing.
- B = average weight of the four humidity check specimens before testing.
- C = average weight of the four humidity check specimens after testing.
- D = average weight of the four test specimens after testing.

This formula is applicable regardless of whether the humidity check specimens gain or lose weight.

12. Classification

12.1 The report must include the following information for the treated sample and the untreated control:

- (a) Loss of weight in milligrams.
- (b) Number of larvae alive.
- (c) Number of larvae pupated.

12.2 The test sample is considered satisfactorily resistant to the insect pests used if the average loss of weight due to feeding is not more than 8 mg, provided that under the same conditions the average loss in weight of control specimens is 30 mg or more. No individual test specimen should show more than 10 mg loss of weight.

12.3 The test is invalid if the amount of feeding results in less than 30 mg average weight loss per control specimen or less than 75% of the control larvae survive.

12.4 Individual weight records of test specimens and humidity checks before and after the test may be reported if desired. Humidity check should show no more than 5% variation in weight before and after the test.

13. Referee Test

13.1 In the event of dispute, a disinterested laboratory should conduct the test as follows:

- (a) Weight loss methods are used for both carpet beetles and clothes moths.
- (b) The number of test specimens is doubled.
- (c) All other conditions heretofore set forth apply.
- (d) The results of the referee test are final.

14. Precision and Bias

14.1 *Precision.* Precision for this test method has not been established. Until a precision statement is generated for this test method, use standard statistical techniques in making any comparisons of test results for either *within-laboratory* or *between-laboratory* averages.

14.2 *Bias.* The resistance of textiles to insects can be defined only in terms of a test method. There is no independent method for determining the true value. As a means of estimating this property, the method has no known bias.

15. Notes

15.1 For evaluation of chemical treatments see AATCC Method 28, Insect Pest Deterrents on Textiles.

15.2 AATCC Moth Test Cloth is a standard pure, undyed, scoured wool fabric. Available from: Testfabrics Inc., P.O. Box 26, 415

Delaware St., W. Pittston PA 18643; tel: 570/603-0432; fax: 570/603-0433; e-mail: testfabric@aol.com.

15.3 It is extremely important that contaminating dirt and dust be removed from the intact carpet test specimens since it could be included later in the excrement weight. The test specimens, if their construction permits, can be vacuumed with the open end of a vacuum cleaner hose nozzle to remove dirt, and other particles which might interfere with the subsequent determination of the excrement weight. It is suggested that each test specimen be subjected to the handling which is to be employed later to remove the adhering excrement as described in 8.2.1 before it is subjected to the test conditions.

15.4 Order from Ralston Purina Co., P.O. Box 240, Davenport IA 52802; tel: 319/323-3353.

15.5 Available locally or from General Foods Corp., P.O. Box 60, Youngstown OH 44501.

15.6 Yeasts which have proven satisfactory are (a) Brewers Yeast Powder, Mead Johnson & Co., available at most drug stores, (b) Dry Brewer's Yeast, U.S.P. from Yeast Products, Inc., 455 Fifth Ave., Paterson NJ 07510, with minimum potency, per gram of 150 micrograms thiamine, 45 micrograms riboflavin and 400 micrograms niacin.

15.7 No. 3 Special Filter Cloth from Mechanical Felt and Textiles Co., 50 W. 18th St., Weehawken NJ 07087, and No. 70105 All-Wool Felt Color 10 White, from The American Felt Co., 315 Fourth Ave., New York NY 10014, have been used satisfactorily with the Heal type oviposition cage. Specific fabrics are to be used for rearing moths and must be free of insecticides.

15.8 Available from National Sea Products, Ltd., 39 Upper Water St., Halifax, Canada.

16. Selected References

16.1 Anon. Textile Resistance Test, Official Method of the Chemical Specialties Manufacturers Association for Determining Resistance of Textiles to Insect Pests, 1961 Revision, *Soap and Chem. Specialties*, 1961 Bluebook, pp. 240-243 (1961).

16.2 Anon. Tentative Specification for the Larval Testing of Mothproofed Wool Serge. International Wool Textile Organization. Tentative standard method of test and assessment for proofness of wool serge against the common (webbing) clothes moth, *Tineola bisselliella* (Hum.). *J. Soc. Dyers & Colourists*, Vol. 73, No. 4, pp. 161-165 (1957).

16.3 Ferguson, G. R., Survey on incidence of fabric pest damage. *CSMA Proceedings, Thirty-Sixth Mid-Year Meeting*, pp. 77-79 (1950).

16.4 Heal, R. E., Evaluating protection of fabrics from clothes moth and carpet beetle attack, *J. Econ. Entomol.*, Vol. 35, No. 2, pp. 249-255 (1942).

16.5 Hueck, H. J., The development of a comparative method for the evaluation of the moth-proofness of wool serge. *Ann. Appl. Biol.* Vol. 46, No. 4, pp. 511-528 (1958).

16.6 Laudani, H., A simplified technique for rearing carpet beetles. *Soap and Chem. Specialties*, Vol. 24, No. 10, pp. 139, 143 (1948).

16.7 Mallis, A., Miller, A. C. and Hill, R. C., Feeding of four species of fabric pests on natural and synthetic textiles. *J. Econ. Entomol.*, Vol. 51, No. 2, pp. 248-249 (1958).

16.8 Moncrieff, R. W., *Mothproofing Leonard Hill, Ltd.*, London, 200 pp. (1950).

16.9 Ott, D. J., Identification of insect damage on wool and related animal fibers. *Am. Dyestuff Repr.*, Vol. 44, No. 16, pp. 515-520 (1955).

16.10 Walton, M. M. and Shepard, H. H., Testing resistance of chemically-treated textiles to insect damage. *Methods of Testing Chemicals on Insects*. Vol. 11 (Edited by H. H. Shepard). *Burgess Publishing Company*, Minneapolis MN, pp. 73-100 (1960).

16.11 Waterhouse, D. F., Wool digestion and mothproofing, *Advances in Pest Control Research*. Vol. 11 (Edited by R. L. Metcalf), *Interscience Publishers, Inc.*, NY, pp. 207-262 (1958).

Appendix A

Procedure for Rearing and Handling the Black Carpet Beetle

A1. Scope. The standardized procedure for rearing test insects is an essential part of the standard test procedure for determining resistance of fabrics to insect pests. The following procedure is to be used for rearing the black carpet beetle, *Attagenus megatoma* (F.).

A2. Rearing Containers. Any suitable type of container, such as mason jars, battery jars, tin cans, with filter paper, screen or cloth covers, may be used for rearing the larvae of the black carpet beetle.

A3. Rearing Medium. The following medium is specified:

Purina Laboratory Chow Meal (see 15.4) which passes through U.S. Standard Sieve Series Screen No. 16 with coarse fraction discarded, or

95% by weight Gaines Dog Meal (see 15.5) ground to pass Screen No. 20 plus 5% dry brewer's yeast (see 15.6).

A4. Sterilize the medium to kill mites or insects that may be present. This may be done by an efficient fumigant: 1 mL carbon disulfide per gallon, preferably in sealed glass containers for one week; dry heat 80°C (176°F) for 4 h or 100°C (212°F) for 1 h; or wet heat 103.4 kPa (15 psi) steam for 15 min. Fumigated medium must be spread in shallow trays and aired in a ventilated hood for one or more days before use. Overheating may destroy the food value of the medium.

A5. Sterile medium should be stored in sealed containers. Before using, dry the

medium, and adjust to 13% moisture by adding distilled water.

A5.1 Drying—Spread a quantity of medium to a depth of one-half to three-fourths of an inch in trays and dry to constant weight (30-44 h) in a forced draft oven at 65.5°C (150°F). Cool the medium and temper to 13% moisture immediately.

A5.2 Tempering to 13% moisture—Determine the total weight of the medium and for each 100 g, prepare 15 mL distilled water plus 0.38 mL propionic acid (mold inhibitor). Sieve the medium through a No. 20 screen. Add the combined water and propionic acid to the coarse fraction retained on the screen. Mix thoroughly and continue to mix while adding the fine material that passed through the No. 20 screen. Finally, pour from tray to tray several times, pass through a No. 16 screen, and place in sealed containers until needed for cultures. The final mixture shall contain 13% moisture and 0.33% propionic acid.

A6. Insectary Conditions. The rearing room or incubator should have a constant temperature at 26.6 ± 1°C (80 ± 2°F) and a relative humidity of 55 ± 5%.

A7. Maintenance of Cultures. It is possible to maintain cultures of the black carpet beetle so that larvae of testing size and age are available at all times. This can be accomplished only when overcrowding is prevented and cultures are kept well supplied with food.

A8. The black carpet beetle completes its life cycle in 8-10 months when reared and handled under optimum conditions, as follows:

A8.1 Once each week, pass maturing stock larvae cultures through a U.S. Standard Sieve Series Screen No. 16 and collect adults and pupae separately. The majority of the pupae and the mature larvae can be separated by spreading them out on kraft paper. The larvae tend to cling to the paper when it is rolled and tilted to an upright position over a pan. The pupae fall into the pan and then the clinging larvae can be shaken into another pan. A No. 8 screen is useful for separating the small number of larvae still remaining with the pupae. The pupae are to be kept in a screen-covered jar for one week for emergence. Collect the adults emerged from the pupae collected the previous week and add to those collected from stock after discarding all deformed specimens. Count out 50 adults at random and measure their volume in a 15 mL centrifuge tube. The volume of 50 adults should be 1.2-1.5 mL if they have developed normally. Transfer the adults to a pint jar three-fourths full of medium (containing 13% water). Cover the jar with a filter paper lid, and set it aside to age.

A.9 The majority of eggs are laid during the next 10 days and these hatch to 12 days after laying. The eggs are too fragile to be handled without injury and the jar must not be disturbed for at least 11 weeks. At this time, pass its contents through a No. 20 screen. A gentle stream of air, such as is produced by a hair dryer, is useful in removing cast skins. The larvae and coarse material (dead adults, coarse food particles, etc.) retained on the No. 20 screen are then separated by placing the material on the high end of a sloping platform (see 16.6) or tray. By putting a light over this end, the larvae, since they are negatively phototropic, will crawl away from the coarse material and collect at the other end of the tray. The collected larvae are then allowed to crawl through nested No. 14, No. 16 and No. 20 screens under a light. After 5 min, the contents of the screens can be emptied into separate trays. Larvae caught in the mesh are gently stimulated with a soft brush to crawl through the screen or they can usually be removed without injury with Ward's feather-weight entomological forceps. Mites may be removed from larvae, pupae, or adults by placing the infested insects in a jar that is half filled with sterilized rearing medium and rotating the jar, screening to separate larvae from the medium, and destroying or sterilizing this food which contains mites. It may be necessary to repeat this procedure several times.

A10. Measure the volumes of larvae collected in a centrifuge tube and estimate the percentage represented by each fraction, based on total numbers. For this purpose, 1 mL contains approximately 45 larvae held on a No. 14 screen, 70 larvae held on a No. 16 screen, and 90 larvae held on a No. 20 screen. The number of larvae passed through the No. 20 screen should be estimated roughly and made a part of the total. If 10-20% of the larvae are not of a size to be held on the No. 14 screen, return all fractions of the larvae and medium to the same jar and age one or two weeks longer. The above step is quite important if satisfactory test larvae are to be obtained. When the jar first produces 10-20% of larvae held on the No. 14 screen, collect 6 mL of the larvae held on the No. 16 screen (approximately 400), pass them through sterile medium to remove mites, and transfer to quart jar three-fourths filled with medium. Save the remaining larvae held on the No. 16 screen for tests and discard the larvae held on the No. 14 and the No. 20 screens. Add 6 mL of larvae held on a No. 16 screen from new cultures on each of the following three weeks before starting a new jar. These are stock larvae cultures, which will produce pupae 6-8 months later. Three months and five months after starting the stock cultures,

remove larvae from medium by a No. 16 screen as described in A9 and transfer to fresh medium.

A11. At the time the stock larvae are collected, test larvae may be collected by means of the No. 14 and No. 16 screens. Larvae held on the No. 16 screen are test size, and average 6-7 mg in weight. The unused larvae held on the No. 16 screen can be saved for possible use as test larvae that same week. All remaining larvae should be discarded at the end of the week.

A12. A few weeks' experience will determine the age of cultures meeting the requirements for sizing and use of larvae. A deviation of more than one week from this age indicates an abnormal rearing condition which may be caused by food, mites, or various other environmental or handling conditions. Abnormal cultures should be discarded.

Appendix B

Procedure for Rearing and Handling the Webbing Clothes Moth

B1. Scope. The following procedure is to be used for rearing and handling the webbing clothes moth, *Tineola bisselliella* (Hum):

B2. Rearing Containers. Wide-mouth jars of 0.950-1.893 L (1 or 2 qt) capacity are suggested. The flat lid is replaced by coarse filter paper and held in place by the ring used to fasten the discarded lid. Other types of containers of similar size are satisfactory.

B3. Oviposition Cage. Adult moths are placed in a pint jar containing 4-6 squares of clean, all-wool fabric 7.6 × 7.6 cm (3 × 3 in.). Allow these adults to deposit their eggs on these pieces of fabric for 2-4 days. At the end of this period remove the adults and destroy. Since the eggs hatch in 4 days, this is the maximum interval that may be allowed between egg collections.

B4. Another type of oviposition cage that is used by some laboratories is patterned after that described by Heal (see 16.4). It consists of a wide-mouthed tin can 16.5 cm (6.5 in.) high and 15.2 cm (6 in.) in diameter. The bottom is removed and replaced with 16 mesh screen wire. Woolen flannel is placed beneath the screen and supported in place by a cardboard circle fastened with masking tape to the rim of the can. A closure for the culture jars is soldered in place in an inverted position in the center of the lid of the can and an opening 5.1 cm (2 in.) in diameter is cut in the can lid within the area enclosed by the closure. A culture jar with emerging adults is fastened in place in the closure and a bright light shined on the glass culture jar to drive the adults into the oviposition cage. At inter-

vals of not more than 4 days, the flannel can be removed and the eggs collected by dislodging with a stiff brush and handled as described in B6 below.

B5. Rearing Medium. Use clean, scoured, undyed wool cloth (see 15.7) supplemented with about one teaspoonful of autoclaved dry brewer's yeast (see 15.6) or fish meal (see 15.8) to each 30 g of cloth. Refer to A4 for instructions on autoclaving yeast.

B6. Insectary Conditions (see A6).

B7. Maintenance of Culture. The adults in mature cultures are transferred to the oviposition cage either by suitable suction or by introducing into the container with the adults a small amount of CO₂ gas. The adults can then be removed from the container and transferred to the oviposition jar without difficulty, 400-500 adult webbing clothes moths will deposit approximately 4,000 eggs in two or four days. The 7.6 × 7.6 cm (3 × 3 in.) pieces of fabric are then placed in an enamel pan and vigorously brushed with a 1.27 cm (0.5 in.) glue brush to remove the eggs. The eggs are screened through a 40-mesh sieve and retained on a 60-mesh sieve. The eggs are measured in a graduated centrifuge tube, 0.2 mL representing approximately 4,000 eggs. These are sprinkled on 10.2 × 25.4 cm (4 × 10 in.) strips of clean scoured wool fabric (total 25-30 g wool) treated with about a teaspoonful of dry yeast. The roll of wool strips is then placed in a 0.950 or 1.893 L (1 or 2 qt), wide-mouth jar, covered with filter paper lid, and kept under conditions described in A6 until of test age. Some workers wrap the roll of wool strips in a 12.7 × 38.1 cm (5 × 15 in.) strip of wool felt to give it more support in the rearing jar.

Appendix C

Procedure for Rearing and Handling the Furniture Carpet Beetle

C1. Scope. The following procedure is to be used for rearing and handling the furniture carpet beetle, *Anthrenus flavipes* LeConte:

C2. Rearing Containers (see B2).

C3. Rearing Medium (see B5).

C4. Insectary Conditions (see A6).

C5. Maintenance of Cultures. Place approximately 60 pupae in a rearing jar (see A2) with several 7.6 cm (3 in.) squares of wool cloth supplemented with dry brewer's yeast or fish meal.

C6. Examine rearing jars at weekly intervals and provide sufficient supplemental wool cloth to maintain an adequate food supply.

C7. About eleven weeks after the pupae were placed in the rearing jars, the larvae are removed from the wool cloth, excrement, pupal cases, etc. After removing the excrement and excess brewer's

yeast with a 40-mesh sieve, larvae clinging to the cloth can be removed with a soft brush. If handled carefully, the larvae may also be transferred with light forceps.

C8. The collected larvae are then allowed to crawl through nested No. 14, No. 16, and No. 20 screens under a light. The larvae held on the No. 20 screen are test size and average 1.0-1.5 mg in weight. If more than half of the larvae pass through the No. 20 screen, return all fractions of the larvae and medium to the same jar and age one week longer. A few weeks experience will determine the age of cultures meeting the requirements for sizing and use of larvae.

C9. A portion of the larvae not used for tests can be placed in a large stock jar which serves as a source of supply of pupae for the rearing jars.

Appendix D

Consideration of Visible Damage

D1. It should be noted that in this test method the criteria for determining the acceptability or unacceptability of a mothproofing treatment are limited to the strictly quantitative excrement weight and fabric weight loss measurements. Although visible damage ratings can be used under certain conditions, they are not suitable for a standard method which must necessarily be used under a wide range of conditions; e.g., visible damage ratings would not give reliable results when (1) more than one type of material is involved, and (2) when comparing the results of different investors.

D2. Mothproofing treatments are submitted to the Environmental Protection Agency's Office of Pesticide Programs,

Registration Division, for acceptance of label claims. The acceptable protocol and methodology for the necessary tests to determine the efficacy and usefulness of a mothproofing treatment are found in the "Appendix to Guidelines for Registering Pesticides in the United States, Part IV—Product Performance, Subpart E—Invertebrate Control Agents."

D3. Laboratories using AATCC Test Method 24 with the intention of submitting results to the Registration Division, EPA Office of Pesticide Programs, are *cautioned to take notes on visible damage*. Reports on visible damage may be requested in addition to the reports on excrement weight and fabric weight loss.

D4. Discussions with the Registration Division, EPA Office of Pesticide Programs, as to the detailed requirements for testing are always desirable.

Ageing of Sulfur-Dyed Textiles: Accelerated

Developed in 1943 by AATCC Committee RR9; revised 1952, 1975; reaffirmed 1944, 1972, 1978, 1983, 1988, 1989, 1999; editorially revised 1990; editorially revised and reaffirmed 1994, 2004.

1. Purpose and Scope

1.1 This test method describes a procedure for determining whether sulfur-dyed textile materials will or will not deteriorate under normal storage conditions and to establish the degree of such deterioration.

2. Principle

2.1 Specimens are steam-aged in a moist atmosphere under controlled conditions and then tested for loss in strength to determine if storage deterioration is likely.

3. Terminology

3.1 **accelerated ageing**, n.—*in textile processing and testing*, use of controlled environmental conditions to promote rapid physical and/or chemical change in a textile material.

3.2 **sulfur dye**, n.—a dye, containing sulfur both as an integral part of the chromophore and in attached polysulfide chains, normally applied in the alkali-soluble reduced (leuco) form from a sodium sulfide solution and subsequently oxidized to the insoluble form in the fiber.

4. Safety Precautions

NOTE: These safety precautions are for information purposes only. The precautions are ancillary to the testing procedures and are not intended to be all inclusive. It is the user's responsibility to use safe and proper techniques in handling materials in this test method. Manufacturers MUST be consulted for specific details such as material safety data sheets and other manufacturer's recommendations. All OSHA standards and rules must also be consulted and followed.

4.1 Good laboratory practices should be followed. Wear safety glasses in all laboratory areas.

5. Apparatus

5.1 Conventional laboratory drying oven (see 10.1), uniformly heated and controlled to $\pm 2^\circ\text{C}$ ($\pm 4^\circ\text{F}$). It should be provided with ventilating ports and some

means for introducing moisture (see 10.2) or;

5.2 Steam ager (see 10.3) equipped with proper controls for uniform steam flow and temperature.

6. Test Specimens

6.1 Suitable test specimens are taken and blanks of the same material, dyed and undyed, used.

7. Procedure

7.1 Oven Test. Expose the specimens to $135 \pm 2^\circ\text{C}$ ($275 \pm 4^\circ\text{F}$) heat in the oven for 6 h continuously. At the beginning of the second, third, fourth, fifth and sixth hours the ports or vents are closed and 20 mL of water added for each 0.03 m^3 (1.0 ft^3) of oven capacity. The vents are kept closed for 5 min, then opened and circulation resumed for the rest of the period. As an alternate method the test specimens may be removed from the oven at the end of each hour and thoroughly humidified in an atmosphere of steam, then replaced in the oven. At the end of the 6 h of heating, the specimens are removed from the oven and placed in a conditioning room, if available.

7.1.1 Alternate Oven Test. Expose the specimens to $135 \pm 2^\circ\text{C}$ ($275 \pm 4^\circ\text{F}$) heat in the oven for 6 h continuously. At the beginning of the test, 100 mL of water for each 0.03 m^3 (1.0 ft^3) of oven capacity is introduced into the oven in a vessel having a surface area of approximately 413 cm^2 (64 in.^2). The vents are left open during the entire test. At the end of the 6 h of heating, the specimens are removed from the oven and placed in a conditioning room, if available. Under the conditions above, it has been found that the water will require from 1.75-2.0 h to evaporate.

7.2 The Steam Ager Test. The test specimens may be suspended while aging, or may be tacked on frames, which are then placed in the steam ager, pyramid style, with the bottom baffle functioning as a support. The specimens are aged for 8 h with saturated steam at 103 kPa (15 lb) pressure, or for 16 h at 51.7 kPa (7.5 lb) pressure. After the aging test is completed the specimens are removed from the ager and placed in a conditioning room, if available.

8. Evaluation of Results

8.1 Determine the breaking strength (see 10.4) of the aged specimens to eval-

uate the degree of deterioration due to ageing. Test specimens and unaged blanks should be conditioned for 16 h at standard conditions, $65 \pm 2\%$ RH and $21 \pm 1^\circ\text{C}$ ($70 \pm 2^\circ\text{F}$), before making breaking strength tests (see 10.5). A minimum of 10 significant breaks should be made and the results averaged. Results are reported as percent loss (or gain) in strength based on the unaged material.

8.2 As an option, degree of deterioration may be determined from a cuprammonium fluidity test.

9. Precision and Bias

9.1 *Precision*. Precision for this test method has not been established. Until a precision statement is generated for this test method, use standard statistical techniques in making any comparisons of test results for either *within-laboratory* or *between-laboratory* averages.

9.2 *Bias*. The accelerated ageing of sulfur-dyed textiles can be defined only in terms of a test method. There is no independent method for determining the true value. As a means of estimating this property, the method has no known bias.

10. Notes

10.1 The oven used may be of any conventional design and constructed of conventional material as long as the heating elements or materials of construction do not give off gases when heated which would tend to distort the results. The quantity of materials tested must bear a fixed relationship to the capacity of the oven, 25 g of materials tested per 0.03 m^3 (1 ft^3) of oven capacity being considered correct.

10.2 The temperature control must be accurate within $\pm 2^\circ\text{C}$ ($\pm 4^\circ\text{F}$). Care must be exercised to insure that the thermometer indicates the true and correct internal temperature of the area in which the samples are being tested.

10.2.1 The oven should be equipped with ports or vents of such size as to allow the air in the oven to be changed approximately every 2 min except when humidifying. This may be accomplished by natural convection or by a circulating system. During humidification the ports or vents should be closed to confine the moisture within the oven for the specified time.

10.2.2 Controlled amounts of water (or steam) should be admitted into the oven at specified intervals. This may be entered through either the top or the side of the oven. The requisite amount of water should be added onto a heated mass of material in order to effect rapid vaporization. To effect this relatively rapid vaporization the weight of mate-

rial should be approximately 100 g for each gram of water admitted per hour. The amount of water admitted should be sufficient to cause the filling of the oven with steam at atmospheric pressure each hour. 20 mL of water produces approximately 0.03 m³ (1 ft³) of vapor at atmospheric pressure and at 135°C (275°F). In addition to the desired rapid vaporization of the water admitted, the mass of metal or other materials acts as a temperature stabilizer and serves to prevent a sudden drop in temperature owing to the latent heat of vaporization of the water introduced. Ovens meeting the specifications of the ASTM for accelerated aging of rubber, equipped with automatic humidity control, are acceptable (see ASTM E 145).

10.2.3 Provision must be made for holding specimens to be tested so that they will not

come in contact with the hot metal portion of the oven. A suitable means is to hang the materials tested by strings from glass or wooden rods in a manner to assure their not coming in contact with each other or with the sides of the oven. Materials tested must be held in that part of the oven where the temperature is constant and uniform and where all portions of tested specimens are exposed to the same temperature and the same conditions of humidity and atmospheric change.

10.3 A typical steam ager consists essentially of a closed cylinder, 58 cm (23 in.) long by 38 cm (15 in.) diameter, inside measurement, one end of which is a swinging door. A groove in the face of the cylinder holds a gasket against which the door is held tightly by a lever clamp. The apparatus is equipped with a pressure gauge, automatic temperature re-

corider, steam inlet with handcock flow control valve, petcock, trap and baffle of thin stainless steel sheet metal in the top half to prevent dripping from condensation. A wooden frame 56 × 36 cm (22 × 14 in.), covered with coarse cloth and supported by protruding bolts in the sides along the center, serves as a bottom baffle to prevent possible splashing. However, any steam ager equipped with the proper controls for uniform steam flow and pressure may be adapted to this test procedure.

10.4 Since comparative, but not absolute, results are to be obtained, any suitable breaking strength machine may be used which is adaptable to breaking the specimens being tested.

10.5 If possible, breaking strength tests should be conducted in an atmosphere of controlled humidity as described above.

Wetting Agents: Evaluation of Rewetting Agents

Developed in 1944 by AATCC Committee RA8; jurisdiction transferred in 2003 to AATCC Committee RA63; revised 1952; reaffirmed 1971, 1974, 1977, 1980, 1989, 1999; editorially revised and reaffirmed 1985, 1994, 2004; editorially revised 1988, 1991, 1992.

1. Purpose and Scope

1.1 This test method provides a means of measuring the effectiveness of commercial rewetting agents on cotton fabrics.

2. Principle

2.1 A test specimen is padded in a water solution of a rewetting agent and dried. A drop of water is then carefully deposited on the taut surface of the specimen and the time required for the specular reflection of the water is recorded as rewetting time.

3. Terminology

3.1 **rewetting agent**, n.—in *textile preparation, dyeing and finishing*, a surfactant which, after application and drying onto textiles, promotes rapid wetting on subsequent exposure to an aqueous solution.

3.2 **wetting agent**, n.—a chemical compound which when added to water lowers both the surface tension of the liquid and its interfacial tension against the solid material.

4. Safety Precautions

NOTE: These safety precautions are for information purposes only. The precautions are ancillary to the testing procedures and are not intended to be all inclusive. It is the user's responsibility to use safe and proper techniques in handling materials in this test method. Manufacturers MUST be consulted for specific details such as material safety data sheets and other manufacturer's recommendations. All OSHA standards and rules must also be consulted and followed.

4.1 Good laboratory practices should be followed. Wear safety glasses in all laboratory areas.

4.2 Observe padder safety. Normal safeguards on pad should not be moved. Ensure adequate guard at the nip point. A foot-operated kickoff is recommended.

5. Apparatus and Materials

5.1 Rewetting agents.

5.2 Cloth, fairly heavy cotton, in the greige; cloth must not have been boiled, bleached or desized. Cotton sateen (see 9.1) is suggested for use in this test.

5.3 Small padder. A household wringer with improvised pad box is satisfactory in lieu of a small padder.

5.4 Embroidery hoop, 15.2 cm (6 in.).

5.5 Burette delivering 15-25 drops per mL.

5.6 Stopwatch.

5.7 Conditioned room in which standard temperature $21 \pm 1^\circ\text{C}$ ($70 \pm 2^\circ\text{F}$) and humidity ($65 \pm 2\%$ RH) are maintained. Although satisfactory comparisons can be made in the ordinary laboratory, the results should be more reproducible under standard conditions.

6. Procedure

6.1 Application of rewetting agent—a solution of the rewetting agent is prepared by pouring 100 mL of hot water over the required amount of the product in a small beaker or casserole. This solution is heated above 97°C (200°F) for a moment and then is diluted with hot water to a final volume of 1 L. The temperature of the solution in the padder box for application should be $70 \pm 3^\circ\text{C}$ ($158 \pm 5^\circ\text{F}$).

6.2 The padder is adjusted to a uniformly firm squeeze from side to side. On a household wringer it has been found that a dozen half turns of the wing nuts from the place where they just begin to take hold is satisfactory.

6.3 A strip of the selected cotton goods is padded *three times* through the solution of the rewetting agent. Three times through ensures thorough and uniform penetration of the cloth. The pickup should be from 60-90%.

6.4 The padded cloth is dried in air at approximately 82°C (180°F) for 30 min.

6.5 Four strips of padded cotton are prepared for each rewetting agent representing, respectively, four concentrations for each product to be tested. Concentrations generally suitable are 2.50, 5.0, 10.0 and 20.0 g of rewetting agent per liter.

6.6 Rewetting—a square of the padded, dried and conditioned cloth is mounted in the embroidery hoop. The burette containing either distilled water or tap water, whichever is desired for the test, is adjusted so that it delivers one drop of water at $21 \pm 1^\circ\text{C}$ ($70 \pm 2^\circ\text{F}$) approximately every 5 s. The surface of the taut cloth is held about 1 cm (0.375 in.) below the tip of the burette and the stopwatch is started just as the drop falls on

the cloth. The watch is stopped when the liquid on the surface of the cloth loses its specular reflective power. This point is determined by placing the hoop between the observer and a source of light—such as a window—at such an angle that the specular reflection of light from the surface of the flattened drop can plainly be seen. As the drop is gradually absorbed the area of this tiny mirror diminishes and finally vanishes entirely leaving only a dull wet spot behind. It is at this moment that the watch is stopped.

7. Evaluation

7.1 Readings of rewetting time are made so easily and quickly that ten are taken for each concentration. The average times of disappearance of a drop for 2.50, 5.0, 10.0 and 20.0 g of rewetting agent per liter of pad liquor are then plotted on log-log coordinate paper with concentration as the abscissa (X-axis). A straight line is drawn to approximate the four points as nearly as possible.

7.2 From this line relating disappearance time to concentration, one can find the concentration which would give a disappearance time of 10 s. This is called the rewetting concentration for the product. A corresponding value is then determined for the second rewetting agent. By using a simple proportion with these figures it can be calculated how many parts of the second product are equivalent to 100 parts of the first product (or Standard) for rewetting.

8. Precision and Bias

8.1 *Precision*. Precision for this test method has not been established. Until a precision statement is generated for this test method, use standard statistical techniques in making any comparisons of test results for either *within-laboratory* or *between-laboratory* averages.

8.2 *Bias*. Rewetting agents can be defined only in terms of a test method. There is no independent method for determining the true value. As a means of estimating this property, the method has no known bias.

9. Notes

9.1 Available from Testfabrics Inc., P.O. Box 26, 415 Delaware St., W. Pittston PA 18643; tel: 570/603-0432; fax: 570/603-0433; e-mail: testfabric@aol.com.

Insect Pest Deterrents on Textiles

Developed in 1940 by AATCC Committee RA49; Jurisdiction transferred in 1994 to AATCC Committee RA31; revised 1949, 1962; reaffirmed 1956, 1971, 1974, 1977, 1980, 1985, 1989, 1999; editorially revised 1974, 1988, 1992; editorially revised and reaffirmed 1994, 2004. Related to ISO 3998.

1. Purpose and Scope

1.1 This test method covers procedures for the evaluation of compounds or treatments designed to protect textile fabrics and yarns from damage by insect pests, such as moths or carpet beetles. They comprehend not only the initial protection furnished by the treatment, but also the permanency of the protection during conditions of ordinary service.

2. Principle

2.1 Treated and untreated specimens are subjected to the action of insect pests under controlled conditions for one exposure period and then examined for evidence of damage. Additional exposure periods are given as necessary until visual damage is evident.

3. Terminology

3.1 **insect resistance**, *n.*—*in textiles*, the capability to impede damage by insects.

4. Safety Precautions

NOTE: These safety statements are for information purposes only. The precautions are ancillary to the testing procedures and are not intended to be all inclusive. It is the user's responsibility to use safe and proper techniques in handling materials in this test method. Manufacturers MUST be consulted for specific details such as material safety data sheets and other manufacturer's recommendations. All OSHA standards and rules must be consulted and followed.

4.1 Good laboratory practices should be followed. Wear safety glasses in all laboratory areas.

4.2 All chemicals should be handled with care. Use chemical goggles or face shield, impervious gloves and an impervious apron during dispensing and mixing of the chemicals used in this test method.

4.3 Perchloroethylene is toxic by inhalation, by repeated contact with the skin and by ingestion. It must be used only in

a well vented atmosphere. Toxicology studies with laboratory animals have shown evidence of cancer in rats and mice exposed to perchloroethylene vapors at 100-400 ppm concentrations for prolonged times. Fabric saturated with this solvent must be dried in an adequately ventilated hood.

4.4 An eyewash/safety shower should be located nearby and an organic vapor respirator should be readily available for emergency use.

4.5 Exposure to chemicals used in this procedure must be controlled at or below levels set by governmental authorities (e.g., Occupational Safety and Health Administration's [OSHA] permissible exposure limits [PEL] as found in 29 CFR 1910.1000 of January 1, 1989). In addition, the American Conference of Governmental Industrial Hygienists (ACGIH) Threshold Limit Values (TLVs) comprised of time weighted averages (TLV-TWA), short term exposure limits (TLV-STEL) and ceiling limits (TLV-C) are recommended as a general guide for air contaminant exposure which should be met (see 18.7).

5. Apparatus and Materials

- 5.1 Flat iron
- 5.2 Moth cloth (see 18.1)
- 5.3 Perchloroethylene
- 5.4 Stoddard solvent

6. Test Specimens

6.1 Test specimens are prepared by applying the treatment or compound to be tested in the desired proportion to a piece of standard pure undyed scoured wool (see 18.1). After application, the specimen is thoroughly aired for a period of not less than 7 days for the removal of all volatile constituents. The size of the piece should be sufficient to furnish specimens for all of the service tests to which it is to be subjected.

6.2 If it is desired to determine the resistance of the treatment on a special fabric, test specimens are prepared as described in 6.1 using the special fabric instead of the standard fabric.

7. Resistance to Insect Pests

7.1 The resistance of the treated specimens to insect pests is determined in accordance with AATCC Test Method 24, Resistance of Textiles to Insects (with the exception that 28-day test periods should be employed), both immediately after the

preparation of the fabric and airing described in 6.1, and also after subjecting it to any or all of the service tests described in 8-13 (see 18.2).

8. Washing

8.1 The treated specimen is washed according to the procedure described below, and the washing is repeated up to 5 times as desired.

8.2 The tests are to be run for 5 min at $38 \pm 2^\circ\text{C}$ ($100 \pm 5^\circ\text{F}$) in a soap solution containing 0.2% neutral chip soap (see 18.3) using a bath ratio of 30 times as much water as fabric. The specimens after hand washing (squeezing suds through fabric) in this soap solution are rinsed twice in water at approximately 29°C (85°F) using the same ratio of water as in the washing, that is, 30:1.

9. Cleaning

9.1 Apparatus. The apparatus consists of a Launder-Ometer or similar machine.

9.2 Stoddard Solvent (see 18.4) Solution. The soap is made by dissolving 56 g of potassium hydroxide in 100 mL of water. This solution is poured slowly with constant stirring into a mixture of 340 g of oleic acid, 400 mL of Stoddard solvent and 100 mL of tertiary butyl alcohol or an equal quantity of Butyl Cellosolve.

9.3 Perchloroethylene Solution. Prepare the solution in accordance with the procedure described in 9.2 except that perchloroethylene is used instead of Stoddard solvent.

9.4 Drycleaning with Stoddard Solvent (see 18.5). Each specimen is placed in a 1 pt. preserving jar containing the necessary volume of cleaning solution prepared by mixing together 50 mL of Stoddard solvent and 0.6 mL of drycleaning soap solution for each gram of specimen. Place the jar in the machine and operate it for 25 min. Pour out the solution, and add 100 mL of fresh Stoddard solvent without soap to the jar. Return the jar to the machine and operate it for an additional 10 min. Remove the specimen from the jar, and without squeezing lay it out on a horizontal surface such as a muslin-covered frame or screen, and allow to dry at room temperature. The cleaning may be repeated as many as five times.

9.5 Alternative Drycleaning with Perchloroethylene. Dryclean the treated specimen in accordance with the procedure described in 9.4 using the perchloroethylene solution instead of the Stoddard

solvent solution. The cleaning may be repeated as many as five times.

9.6 **Wet Cleaning** (see 18.5). Place the specimen cleaned in accordance with the procedure described in either 9.4 or 9.5 on a porcelain slab, or piece of slate, and wet at 32-38°C (90-100°F), with sufficient distilled water, containing 1 g of neutral soap per liter, to keep the specimen thoroughly wet for 15 min. Rinse the specimen by immersing it in 1 L of distilled water at 32-38°C (90-100°F) for 5 min. Remove the specimen and without squeezing, lay it out on a horizontal surface, such as a muslin-covered frame or screen, and allow to dry at room temperature.

9.7 After cleaning, the resistance of the specimen to insect pests is determined.

10. Hot Pressing

10.1 Press the treated specimen by hand in accordance with the following procedure (see 18.5). Lay the specimen on a padded ironing board and cover with a damp muslin press cloth, weighing 135.6–152.55 g/m² (4.0–4.5 oz/yd²) previously saturated with water and wrung out so as to retain moisture equal to approximately 75% of its dry weight. Press until dry with a flat iron having a temperature of 135-149°C (271-300°F). Allow the specimen to lie on a smooth horizontal surface for 1 h at room temperature. The specimen may be pressed as many as five times. After pressing, the resistance of the specimen to insect pests is determined.

11. Water

11.1 **Sea Water Solution**. Make up a solution containing 3% of sodium chloride and 0.5% of magnesium chloride.

11.2 **Procedure**. Saturate the treated specimen with the sea water solution, roll fairly tightly and place it in a closed vessel to prevent evaporation. Allow to stand overnight, or for 24 h if desired. The treatment with sea water may be repeated as many as five times. After this treatment, the resistance of the specimen to insect pests is determined.

12. Perspiration

12.1 The treated specimens are subjected to AATCC Test Method 15 for Colorfastness to Perspiration, and the resistance of each specimen to insect pests is then determined.

13. Light

13.1 The treated specimen is exposed to light in the Fade-Ometer in accordance with AATCC Test Method 16, Colorfastness to Light, Option 1. The exposure may be continued for 10, 20 or 40-h periods. After the light test, the resistance of the specimen to insect pests is determined.

14. Abrasion

14.1 The treated specimen is subjected to 2,000 revolutions of the carpet wear test machine in accordance with the procedure described in the paper on Wear of Carpets (see 18.6) published by the National Bureau of Standards. After abrasion the resistance of the specimen to insect pests is determined.

15. Classification

15.1 The classification of the permanency of protection furnished by compounds designed to increase the resistance of fabrics and yarns to insect pests is based upon a comparison of the results obtained by the use of AATCC Test Method 24, Resistance of Textiles to Insects, before and after the application of the service tests prescribed in 7-13.

15.2 The classes of permanency of protection are those for the specific service test as indicated in Table I.

16. Report

16.1 The report should include a designation of classification of the treated specimen with respect to the change in its resistance to insect pests after each of the service tests described in 8-14.

17. Precision and Bias

17.1 **Precision**. Precision for this test method has not been established. Until a precision statement is generated for this test method, use standard statistical techniques in making any comparisons of test results for either *within-laboratory* or *between-laboratory* averages.

17.2 **Bias**. Insect pest deterrents on textiles can be defined only in terms of a test method. There is no independent method for determining the true value. As a means of estimating this property, the method has no known bias.

18. Notes

18.1 Available from Testfabrics Inc., P.O. Box 26, 415 Delaware St., W. Pittston PA 18643; tel: 570/603-0432; fax: 570/603-0433; e-mail: testfabric@aol.com.

18.2 The selection of the particular service tests to be applied to the specimen in question should be governed by the use to which the fabric is to be put.

18.3 Chip Soap Specification, ASTM D 496. Available as Standard Neutral Chip Soap from AATCC, P.O. Box 12215, Research Triangle Park NC 27709; tel: 919/549-8141; fax: 919/549-8933; e-mail: orders@aatcc.org.

18.4 Standard Specifications for Stoddard solvent (ASTM D 235).

18.5 These procedures are adapted from the method for drycleaning described in Paragraphs 26a and 25c of "Commercial Standard for Textiles: Testing and Reporting" (CS59-44), published by the National Institute for Standards and Technology.

18.6 Scheifer, H. F. and Cleveland, R. S., Wear of Carpets, J. Research N.B.S. Vol. 12. No. 2, 155 (1934), Research Paper RP640.

18.7 Available from Publications Office, ACGIH, Kemper Woods Center, 1330 Kemper Meadow Dr., Cincinnati OH 45240; tel: 513/742-2020.

Table I—Evaluation of Compounds for Resistance to Insect Pests

Class	No Change	Appreciable Change
1. Based on Tests Prescribed in Sections 7-12 (numbers indicate repeats of the tests)		
1	...	1
2	1	2
3	2, 3, or 4	5
5	5	...
2. Based on Light Test Prescribed in Section 13		
1	...	10 h
2	10 h	20 h
3	20 h	40 h
5	40 h	...
3. Based on Change After Abrasion Test Prescribed in Section 14		
1	...	2000 revs
5	2000 revs	...

Antifungal Activity, Assessment on Textile Materials: Mildew and Rot Resistance of Textile Materials

Developed in 1946 by AATCC Committee RA31; revised 1952, 1957, 1971, 1981, 1987, 1988 (with title change), 1993, 1999; reaffirmed 1970, 1974, 1979, 1989, 1998; editorially revised and reaffirmed 1986, 2004.

1. General Purpose and Scope

1.1 The two purposes of this test method are to determine the susceptibility of textile materials to mildew and rot and to evaluate the efficacy of fungicides on textile materials.

2. Principle

2.1 Tests I, II, III and IV can be used, singly or in combination, depending on the type of exposure to which the textile material will be subjected. For example, if the final product will come in contact with soil, Test I, which simulates this exposure, should be used; if the finished product will never come in contact with soil or tropical conditions, a much less severe test (e.g., II or III) should be used. Test II is specifically designed for cellulose-containing materials while Test III is for all others. For all materials intended for outdoor and above ground use, Test IV should be used. The two important considerations when evaluating textile materials in relation to fungal growth are (1) the actual deterioration of the textile product (rot), and (2) growth not necessarily deteriorating the product but making it unsightly (mildew) often with an unpleasant and musty odor.

2.2 Certain pre-exposures of textile products may be indicated when specific end-uses are critical (see Appendix A). When the end-use will be near high temperature and the fungicide may be volatile, a preliminary oven exposure may be desired. When the end-use will be in tropical exposures or outside with rainfall present, a leaching exposure should be performed before mildew evaluation is made. When at all possible, the textile material should be exposed to the expected conditions of use prior to performing this test.

3. Terminology

3.1 **mildew resistance**, n.—*in textiles*, resistance to development of unsightly fungal growths and accompanying unpleasant, musty odors on textile materials exposed to conditions favoring such

growths.

3.2 **rot resistance**, n.—*in textiles*, resistance to deterioration of a textile material as a result of fungal growth in or on it.

NOTE: Such deterioration is normally assessed by measuring loss in tensile strength.

4. Safety Precautions

NOTE: These safety precautions are for information purposes only. The precautions are ancillary to the testing procedures and are not intended to be all inclusive. It is the user's responsibility to use safe and proper techniques in handling materials in this test method. Manufacturers MUST be consulted for specific details such as material safety data sheets and other manufacturer's recommendations. All OSHA standards and rules must also be consulted and followed.

4.1 This test should be performed only by trained personnel. The U.S. Department of Health and Human Services publication *Biosafety in Microbiological and Biomedical Laboratories* should be consulted (see 24.1).

4.2 CAUTION: Some of the fungi used in these tests are allergenic and pathogenic; i.e., capable of infecting humans and producing disease. Therefore, every necessary and reasonable precaution must be taken to eliminate this risk to the laboratory personnel and to personnel in the associated environment. Wear protective clothing, respiratory protection, and impervious gloves when working with the organisms. NOTE: Choose respiratory protection that prevents penetration by the spores.

4.3 Good laboratory practices should be followed. Wear safety glasses in all laboratory areas.

4.4 All chemicals should be handled with care.

4.5 An eyewash/safety shower should be located nearby for emergency use.

4.6 Sterilize all contaminated samples and test materials prior to disposal.

4.7 Exposure to chemicals used in this procedure must be controlled at or below levels set by government authorities (e.g., Occupational Safety and Health Administration's [OSHA] permissible exposure limits [PEL] as found in 29 CFR 1910-1000 of January 1, 1989). In addition, the American Conference of Governmental Industrial Hygienists (ACGIH) Threshold Limit Values (TLVs) comprised of time weighted averages (TLV-TWA),

short term exposure limits (TLV-STEL) and ceiling limits (TLV-C) are recommended as a general guide for air contaminant exposure which should be met (see 24.2).

Test I Soil Burial

5. Scope

5.1 This procedure is generally considered to be the most severe test for textile products. Only those specimens that will come in direct contact with soil—such as sandbags, tarpaulins, tents—need to be tested by this procedure. It can also be used for testing experimental textile fungicides.

6. Test Specimens

6.1 Prepare the fabric specimens with dimensions $15.0 \pm 1.0 \times 4.0 \pm 0.5$ cm ($6.0 \pm 0.4 \times 1.5 \pm 0.2$ in.) with the long dimension parallel to the warp and unraveling to 2.5 ± 0.1 cm width (1.0 ± 0.04 in.), or, in the case of fabric with less than 20 threads per 2.5 cm (1.0 in.) to a predetermined number of threads to give a specimen 2.5 ± 1.0 cm in width (1.0 ± 0.4 in.). A sample cutter can also be used (see 24.3). The number of specimens will vary according to the number of variables. The suggested number of specimens is five for each treatment, control and reference fabric.

7. Test Procedure

7.1 Viability control: Expose untreated cotton cloth 271 g/m^2 (8 oz/yd^2) in the soil bed for seven days during the test period to verify fungal activity. The soil bed shall be considered as satisfactory if the viability control fabric loses 90% breaking strength after seven days exposure.

7.2 Soil Bed: Place the air-dry test soil (see 24.4) in trays, boxes or suitable containers to a depth of 13.0 ± 1.0 cm (5.1 ± 0.4 in.) and bring to optimum moisture content by gradual addition of water accompanied by mixing to avoid puddling. After allowing it to stand for 24 h, sieve it through a 6.4 mm (0.25 in.) mesh screen. Maintain uniform moisture content by covering the soil container with a suitable lid. The moisture content of the soil during the test period shall be maintained between $25 \pm 5\%$ (based on dry weight). If the surrounding air is maintained at higher than $83 \pm 3\%$ relative humidity,

the loss of moisture is negligible.

7.3 Incubation: Bury the specimens horizontally on 10.0 ± 1.0 cm (3.9 ± 0.4 in.) of soil, spaced at least 2.5 cm (1.0 in.) apart and then cover with 2.5 ± 0.5 cm (1.0 ± 0.2 in.) of test soil. Incubation periods can vary from 2-16 weeks, depending on severity of service requirements, and other factors of importance to the interested parties. Maintain the temperature at $28 \pm 1^\circ\text{C}$ ($82 \pm 2^\circ\text{F}$) during the test period.

8. Evaluation and Report

8.1 Strength loss determination: Remove specimens, gently wash with water, dry at room temperature for 22 ± 4 h and then condition in an atmosphere of $64 \pm 2\%$ humidity and a temperature of $24 \pm 3^\circ\text{C}$ ($76 \pm 6^\circ\text{F}$) for 24 h. Determine breaking strength by the method outlined in ASTM D 5035, Standard Test Method for Breaking Force and Elongation of Textile Fabrics (Strip Force), using 25×75 mm (1×3 in.) jaw faces. The gage length is determined as 25% of the specimen length. Testing can be performed every two weeks or as specified by the end-user.

8.2 Report: Report the length of exposure to the soil bed, percent retained breaking strength when compared to the unexposed textile, any pre-exposure of specimens before burying and percent retained breaking strength of untreated specimen and/or viability control.

Test II

Agar Plate, *Chaetomium Globosum*

9. Scope

9.1 This procedure is used for evaluating rot resistance of cellulose-containing textile materials that will not come in contact with soil. It may also be used for determining uniformity of fungicide treatment.

10. Test Specimens

10.1 Proceed as in Section 6, if strength loss is to be determined. If only a visual examination is performed, a minimum of five samples is required. However, any number can be tested depending on end-users request. Cut 3.8 ± 0.5 cm (1.5 ± 0.2 in.) diameter discs from both treated and untreated samples.

11. Test Procedure

11.1 Organism: *Chaetomium globosum*. American Type Culture Collection No. 6205 (see 24.5).

11.2 Culture medium (see 24.6): The mineral salts agar should have the following composition:

Ammonium nitrate, NH_4NO_33.0 g
Potassium dihydrogen phosphate,
 KH_2PO_4 2.5 g

Dipotassium hydrogen phosphate,
 K_2HPO_4 2.0 g
Magnesium sulfate,
 $\text{MgSO}_4 \cdot 7\text{H}_2\text{O}$ 0.2 g
Ferrous sulfate,
 $\text{FeSO}_4 \cdot 7\text{H}_2\text{O}$ 0.1 g
Agar..... 20.0 g
Distilled water.....to 1000 mL

11.3 Inoculum: Place agar solution in any desired container such as test tube, French square bottle, Erlenmeyer flask, or petri dish. Sterilize in an autoclave at 103 kPa (15 psi) and 121°C (250°F) for 15 min and cool in a position which affords maximum inoculation surface. After the agar has hardened, under aseptic conditions, place on its surface a disc of filter paper previously sterilized by dry heat in an oven at $71 \pm 3^\circ\text{C}$ ($160 \pm 5^\circ\text{F}$) for 1 h. Streak the filter paper with spores of *Chaetomium globosum* by use of a sterile needle. Incubate at $28 \pm 1^\circ\text{C}$ ($82 \pm 2^\circ\text{F}$) for approximately 10-14 days to produce abundant growth. Remove the filter paper from the container and add it to 50 ± 2 mL of sterile distilled water containing a few glass beads and shake vigorously to bring the spores into suspension. Use this suspension for inoculum in 11.5.

11.4 Culture chamber: Melt mineral salts agar of the composition specified in 11.2 in an autoclave and distribute into any convenient container. Sterilize under conditions given in 11.3 and leave undisturbed until the agar hardens.

11.5 Inoculation: Pre-wet the specimens (but do not rub or squeeze) in water containing 0.05% of a nonionic wetting agent (see 24.7) and place in contact with the hardened agar medium in each container under aseptic conditions. Distribute 1.0 ± 0.1 mL of the inoculum evenly over the $15.0 \pm 1.0 \times 4.0 \pm 0.5$ cm ($6.0 \pm 0.4 \times 1.5 \pm 0.2$ in.) specimens by means of a sterile pipette. Use 0.2 ± 0.01 mL of inoculum for the 3.8 ± 0.5 cm (1.5 ± 0.2 in.) discs. Set up a control specimen, cellulose filter paper or untreated control, in a similar way by using 1.0 ± 0.1 or 0.2 ± 0.01 mL of sterile water.

12. Evaluation and Report

12.1 Strength loss evaluation: Proceed as per 8.1 and report the change in breaking strength as compared to the sample before exposure or the control if available.

12.2 Visual assessment: Report the extent of fungal growth on the discs, using a microscope (50X) where necessary, in accordance with the following scheme:

Observed Growth

No growth

Microscopic growth (visible only under the microscope)

Macroscopic growth (visible to the eye)

Test III Agar Plate, *Aspergillus Niger*

13. Score

13.1 Certain fungi, of which *Aspergillus niger* is one, can grow on textile products without causing measurable breaking strength loss within a laboratory experimental time frame. Nonetheless, their growth may produce undesirable and unsightly effects. This procedure is used to evaluate textile specimens where growth of these fungi is important.

14. Test Specimens

14.1 Cut duplicate 3.8 ± 0.5 cm (1.5 ± 0.2 in.) diameter discs from both treated and untreated samples. Other shapes and sizes can be used provided any anticipated size of the growth-free zone is taken into consideration.

15. Test Procedure

15.1 Organism: *Aspergillus niger*, American Type Culture Collection No. 6275 (see 24.5).

15.2 Culture medium: Proceed as per 11.2. Other suitable media are Czapek (Dox) Agar and Sabouraud Dextrose Agar (see 24.8).

15.3 Inoculum: Add scrapings from a ripe (7-14 days) fruiting culture of *Aspergillus niger* grown on the medium described in 11.2 containing $3.0 \pm 0.1\%$ glucose, to a sterile Erlenmeyer flask containing 50 ± 1 mL of sterile water and a few glass beads. Shake the flask thoroughly to bring the spores into suspension. Use this suspension as the inoculum.

15.4 Inoculation: If the test medium contains glucose, distribute evenly 1.0 ± 0.1 mL of the inoculum over the surface of the agar. Pre-wet the discs (but do not rub or squeeze) in water containing 0.05% of a nonionic wetting agent (see 24.7) and place on the agar surface. Distribute evenly over each disc 0.2 ± 0.01 mL of the inoculum by means of a sterile pipette. If the test medium does not contain glucose, a negative control fabric is required to ensure inoculum viability. Incubate all specimens at a temperature of $28 \pm 1^\circ\text{C}$ ($82 \pm 2^\circ\text{F}$) for 14 days when mineral salts agar is used and for seven days when 3% glucose is added to the mineral salts agar.

16. Evaluation and Report

16.1 At the end of the incubation period, report the percentage of surface area of the discs covered with the growth of *Aspergillus niger*, using a microscope (50X) where necessary, in accordance with the following scheme:

Observed Growth

No growth (if present, report the size of the growth-free zone in mm)

Microscopic growth (visible only under the microscope)

Macroscopic growth (visible to the eye)

Test IV

Humidity Jar, Mixed Spore Suspension

17. Scope

17.1 This test method is designed to determine the fungistatic effectiveness of treatments intended to control mildew and non-pathogenic fungal growth on articles or surfaces composed of textile materials intended for outdoor and above ground use and which are usually waterproofed.

17.2 For this test method visual assessment is used. Additionally, breaking strength may be determined by method as per 8.1.

18. Principle

18.1 Treated and untreated, nutrient-saturated strips of fabric are sprayed with a mixed spore suspension of mildew-causing organisms and incubated at $90 \pm 2\%$ relative humidity. Mildew growth on treated and untreated strips is rated at weekly intervals for up to four weeks.

19. Apparatus

19.1 Glassware: 500 mL French square jars or equivalent with fitting screw caps. Caps are modified by center drilling and inserting an appropriate size stainless steel or brass bolt to which a hook (formed from a 6.5 ± 0.5 cm length [2.6 ± 0.2 in.] of #22 nickel-chromium wire or other non-corrosive wire) is attached.

19.2 Plastic paper clips or nylon thread to suspend the specimens from the screw caps of the French jars.

19.3 Atomizer, DeVilbiss #152 (or equivalent) operated at 69 kPa (10 psi).

19.4 Counting chamber suitable for determining spore concentrations; e.g., hemocytometer.

20. Test Specimens

20.1 The specimens are prepared by cutting 2.5 ± 0.5 cm \times 7.5 ± 0.5 cm (1.0 ± 0.2 \times 3.0 ± 0.2 in.) strips from sample weighing 170.0 ± 34.0 g/m² (5.0 ± 1.0 oz/yd²). For heavier fabrics use strips 2.0 ± 0.5 cm \times 2.0 ± 0.5 cm (0.8 ± 0.2 \times 0.8 ± 0.2 in.).

20.2 Use at least four specimens of each treated and untreated fabric.

20.3 Untreated fabric strips, identical in all other respects to the treated specimens under test, are required to establish the test validity. If untreated fabrics are

not available, use a control cloth with the following requirements:

Cotton: American type, good middling

Warp: 18.5 tex \times 886 \times 2S748

Weft: 30 tex \times 630 \times 2S748

Weave: Plain 34 ends/cm and 17 picks/cm

Mass/unit

area: 230.0 g/m² (6.8 oz/yd²)

Finish: Scoured only

21. Test Procedures

21.1 Organisms:

21.1.1 *Aspergillus niger*, American Type Culture Collection No. 6275.

21.1.2 *Penicillium varians*, American Type Culture Collection No. 10509.

21.1.3 *Trichoderma viride*, American Type Culture Collection No. 28020 (see 24.5).

21.2 Culture medium:

21.2.1 Maintain stock culture of each of test tube slants of potato dextrose agar for *A. niger* and *P. varians*, and malt extract agar for *T. viride* (see 24.6 and 24.8 for media).

21.2.2 Incubate new stock culture 7-10 days at $25 \pm 1^\circ\text{C}$ ($77 \pm 2^\circ\text{F}$), then store at $2-10^\circ\text{C}$ ($36-50^\circ\text{F}$).

21.3 Preparation of conidial suspensions:

21.3.1 Conidial suspensions of fungal organisms are prepared by adding 10 mL of a sterile 0.5% saline solution containing 0.05% of a non-fungicidal wetting agent (see 24.7) to a 7-10 day agar culture.

21.3.2 Scrape the surface of the culture gently with a platinum or nichrome wire to liberate the spores. Agitate the liquid slightly to disperse the spores without detaching mycelial fragments, and gently decant the mold suspension into a flask containing a few glass beads.

21.3.3 Shake the dispersion vigorously to break up any clumps of spores and then filter through a thin layer of sterile cotton or glass wool. Conidial suspensions may be stored at $6 \pm 4^\circ\text{C}$ ($43 \pm 7^\circ\text{F}$) for up to four weeks.

21.3.4 Inoculum for test should be adjusted using a hemocytometer or a Petroff-Hausser bacteria counter to contain five million conidia per mL on day of use by appropriate dilution of stock suspension with saline solution.

21.4 Preparation of test specimens:

21.4.1 To ensure luxuriant growth, both the test and control strips must be saturated with a sterilized glycerol nutrient solution of the following composition: 97.6% distilled water, 2.0% glycerol, 0.1% K₂HPO₄, 0.1% NH₄NO₃, 0.05% MgSO₄·7H₂O, 0.1% yeast extract and 0.05% of a nonionic wetting agent (see 24.7). Adjust the pH to 6.3 ± 0.1 . Sufficient nutrient solution should be pre-

pared to saturate all the specimens used in a single test.

21.4.2 Soak each strip in nutrient for three minutes or until saturated. Squeeze excess liquid and allow fabric strips to air dry before proceeding with application of test fungi.

21.5 Pre-mix equal volumes of well agitated conidial suspensions of *A. niger*, *T. viride* and *P. varians*. Evenly distribute 1.0 ± 0.1 mL of the above suspension onto both sides of each specimen either by spraying or by means of a pipette.

21.6 Suspend fabric strips using plastic paper clips or nylon thread from the caps of individual jars containing 90 ± 3 mL of water each. Hook position must be adjusted so that the bottom ends of attached strips are all at a uniform height above the water level. The caps are tightened, then backed off one-eighth turn to allow for some ventilation.

21.7 Incubate at $28 \pm 1^\circ\text{C}$ ($82 \pm 2^\circ\text{F}$) for 14 days (for non-coated cellulosic textiles) or 28 days (for non-cellulosic or coated cellulosic textiles).

22. Evaluation and Report

22.1 A record of the percent of surface area covered with fungal growth for each strip is made at weekly intervals, or until heavy growth occurs on each sample replicate. Using a microscope (50X) where necessary, assess each specimen in accordance with the scheme given in 12.2.

22.2 After seven days each control strip must show macroscopic growth. If this is not the case repeat the test since test conditions were not valid.

22.3 Any adverse effect of incubation on the fabric; e.g., color changes, flexibility, water repellency, should be qualitatively reported.

22.4 Strength loss determination can be carried out as per 8.1.

22.5 The results of this test method have to be correlated to claims and directions for use recommended for the mildew control product plus any other criteria agreed upon by the interested parties.

23. Precision and Bias

23.1 The precision and bias of this test method are being established. If the breaking strength loss is determined, then refer to the statement given in ASTM D 5035.

24. Notes

24.1 Publication available from U.S. Department of Health & Human Services—CDC/NIH-HHS Publication No. (CDC) 84-8395.

24.2 Booklet available from Publications Office, ACGIH, Kemper Woods Center, 1330 Kemper Meadow Dr., Cincinnati OH 45240; tel: 513/742-2020.

24.3 A JDC Precision sample cutter may be

purchased from Thwing-Albert Instrument Co., 10960 Dutton Road, Philadelphia PA 19154; tel: 215/637-0100; fax: 215/632-8370; Cat. #99 Model JOC25.

24.4 Types of soil which have been found satisfactory for this purpose include garden and naturally fertile topsoils, composts and non-sterile greenhouse potting soils. An equal blend of good topsoil, well rotted and shredded manure, and coarse sand should be used. These usually possess the proper physical characteristics, along with an organic content sufficient to ensure a high degree of microbial activity and the presence of cellulose destroying organisms. The optimum moisture content of these is about 30% moisture above oven dry weight.

24.5 *Chaetomium globosum* ATCC 6205, *Aspergillus niger*, ATCC 6275, *Penicillium varians*, ATCC 10509 and *Trichoderma viride*, ATCC 28020, can be purchased from the American Type Culture Collection, P.O. Box 1549, Manassas VA 20108; tel: 703/365-2700; fax: 703/365-2701.

24.6 Culture medium having composition prescribed in 11.2 (Mineral Salts) can be purchased from Baltimore Biological Laboratories, 250 Schilling Cir., Cockeysville MD 21030.

24.7 Triton™ X-100 (Rohm & Haas Co., Philadelphia PA 19104) has been found to be a

good wetting agent. Suitable alternatives are dioctyl sodium sulfosuccinate or N-methyltauride derivatives.

24.8 These culture media can be bought either from Baltimore Biological Laboratories (see 24.6) or Difco Laboratories, 920 Henry St., Detroit MI 48201.

24.9 ASTM D 5035 can be used for yarn, thread, cordage or tape (see 12.1).

24.10 If testing is being performed for Federal Standards, use AATCC 30-2. Other organisms can be used: *Myrothecium verrucaria* ATCC 9095, QM 460; *Trichoderma* SP ATCC 9645, QM 365; *Memnoniella echinata* ATCC 11973, QM 1225; *Aspergillus niger* ATCC 6275, QM 458; *Aspergillus claratus* ATCC 18214, QM 862.

Appendix A Pre-Treatments

A1. Leaching

A1.1 The leaching should conform in principle to the following procedure: Water from a faucet is passed through a tubing into leaching vessels, care being taken that specimens having different amounts of the same treatment are in separate vessels. Flow is adjusted to ensure a

complete change of water not less than three times in 24 h. The delivery tubes are inserted down through the center of wire mesh cylinders in the leaching vessels and held in the wire cylinders with rubber bands and leached for 24 h. The pH and temperature of the water is recorded and included in the report of the test results.

A2. Volatilization

A2.1 Standard specimens of the fabric to be tested are exposed continuously to dry heat at 100-105°C (212-221°F) for 24 h in a well ventilated oven.

A3. Weathering

A3.1 Portions of the material to be tested are exposed on a series of weathering racks at 45° to the horizontal facing South, between April 1 and October 1, in such a manner as to avoid sagging or flapping. It is recommended that such racks be set up in at least four locations within the United States; e.g., Washington DC; Miami FL; New Orleans LA; and suitable desert locations.

Water Resistance: Rain Test

Developed in 1947 by AATCC Committee RA63; reaffirmed 1952, 1963, 1964, 1967, 1969, 1971, 1974, 1977, 1980, 1985, 1989; editorially revised 1983, 1987, 1998, 2004; editorially revised and reaffirmed 1994; revised 2000.

1. Purpose and Scope

1.1 This test method is applicable to any textile fabric, which may or may not have been given a water-resistant or water-repellent finish. It measures the resistance to the penetration of water by impact, and thus can be used to predict the probable rain penetration resistance of fabrics. It is especially suitable for measuring the penetration resistance of garment fabrics. With the instrument, tests may be made at different intensities (see 11.1) of water impact to give a complete overall picture of the penetra-

tion resistance of a single fabric or a combination of fabrics.

1.2 The results obtained with this test method depend on the water repellency of the fibers and yarns, and on the construction of the fabric.

2. Principle

2.1 A test specimen, backed by a weighed blotter, is sprayed with water for 5 min under controlled conditions. The blotter is then reweighed to determine the amount of water which has leaked through the specimen during the test.

3. Terminology

3.1 **water resistance, n.**—*of fabric*, the characteristic to resist wetting and penetration by water. (See also *water repellency*.)

4. Safety Precautions

NOTE: These safety precautions are for information purposes only. The precautions are ancillary to the testing procedures and are not intended to be all inclusive. It is the user's responsibility to use safe and proper techniques in handling materials in this test method. Manufacturers MUST be consulted for specific details such as material safety data sheets and other manufacturer's recommendations. All OSHA standards and rules must also be consulted and followed.

4.1 Good laboratory practices should be followed. Wear safety glasses in all laboratory areas.

5. Apparatus and Materials

5.1 AATCC Rain Tester (see Figs. 1, 2 and 3 and 11.3).

5.2 White AATCC Textile Blotting Paper (see 11.4).



Fig. 1—Rain tester, complete assembly.

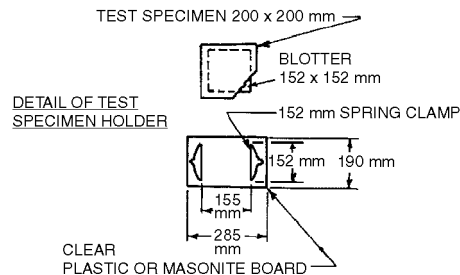
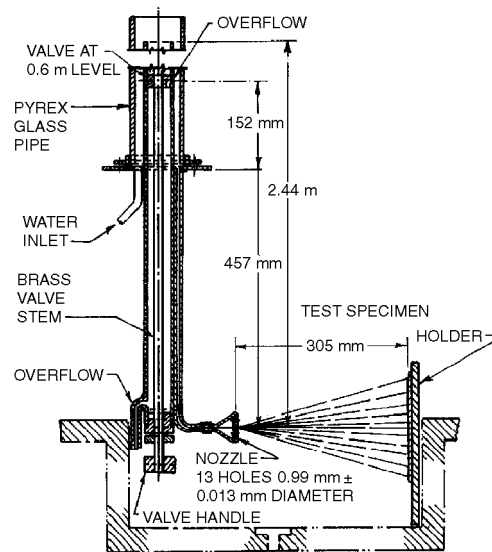

Fig. 2—Rain tester, structural details.

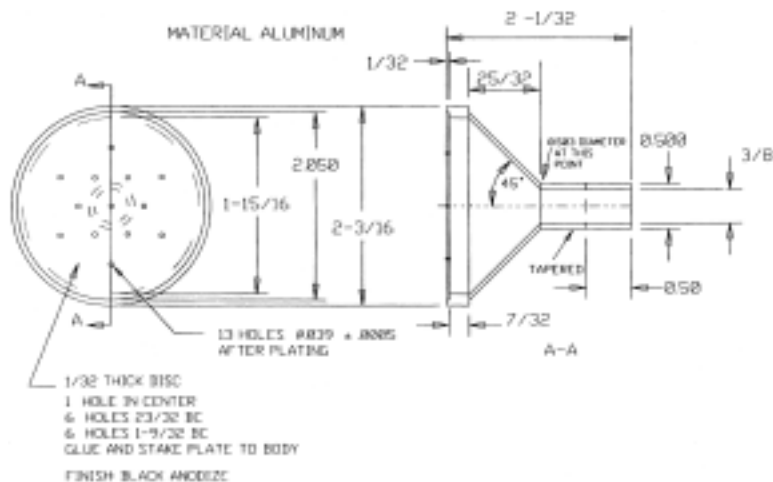

Fig. 3—Rain tester, nozzle.

6. Test Specimens

6.1 A minimum of three specimens of 20×20 cm is cut from the test fabric. The fabric samples and the blotting paper should be conditioned in an atmosphere of $65 \pm 2\%$ RH and $21 \pm 1^\circ\text{C}$ for at least 4 h before testing.

7. Procedure

7.1 The test specimen (see 11.5), backed by a 15.2×15.2 cm standard paper blotter weighed to the nearest 0.1 g is clamped in the specimen holder and the assembly is mounted in a vertical rigid support frame. The specimen assembly is positioned into the central portion of the spray at a distance of 30.5 cm from the face of the spray nozzle (see 11.6). A horizontal water spray at $27 \pm 1^\circ\text{C}$ (see 11.2) is directed against the specimen and is allowed to continue for a period of 5 min. At the end of the spray period the blotter is carefully removed and quickly reweighed to the nearest 0.1 g.

8. Evaluation

8.1 Water penetration as indicated by the increase in mass of the blotting paper during the 5 min test period is calculated, and the average for the three test specimens is reported. Individual determinations or average values of over 5.0 g may be simply reported to 5 + g or > 5 g.

8.2 In order to obtain a complete overall picture of the penetration resistance of a fabric or fabric combination the average penetration with different pressure heads

on the nozzle should be obtained. The pressure head should be varied by 300 mm increments in order to determine (a) the maximum head at which no penetration occurs, (b) the change in penetration with increasing head and (c) the minimum head required to cause “break-down” or the penetration of more than 5 g of water. At each pressure head a minimum of three specimens should be tested in order to obtain the average penetration for that head.

9. Report

9.1 Report the individual determinations. For values of over 5.0 g simply report as 5 + g or > 5 g.

10. Precision and Bias

10.1 *Precision.* Precision for this test method has not been established. Until a precision statement is generated for this test method, use standard statistical techniques in making any comparisons of test results for either *within-laboratory* or *between-laboratory* averages.

10.2 *Bias.* The bias derived by this procedure can be defined only in terms of a test method. There is no independent, referee test method by which bias may be determined. This test method has no known bias.

11. Notes

11.1 The intensities are produced and controlled by means of a column of water which may be adjusted to 0.6, 0.9, 1.2, 1.5, 1.8, 2.1

and 2.4 m above the nozzle. This is done by means of a glass pressure column to which a nozzle is connected. The adjustment is made by a simple setting of a valve at the lower end of the drain or overflow pipe which extends up through the center of the glass column. A filtering device between the pressure gauge and the glass column may be used to prevent clogging of the nozzle openings. It may be eliminated in localities where the water supply is relatively free from iron rust or other suspended matter. A pressure gauge on the supply line also is an accessory which usually can be eliminated in the interest of economy.

11.2 The temperature of the supply water may be measured by means of a thermometer, but recent work has shown that it is more conveniently and accurately measured with a thermometer suspended in the glass pressure column or immersed in a beaker placed to catch water from the overflow.

11.3 The AATCC Rain Tester is available from AATCC, P.O. Box 12215, Research Triangle Park NC 27709; tel: 919/549-8141; fax: 919/549-8933; e-mail: orders@aatcc.org. Information relative to the principle of the instrument may be obtained by reference to the original article by Slowinske, G.A. and Pope, A.G., *American Dyestuff Reporter* 36, 108 (1947).

11.4 Blotters suitable for this test can be obtained from AATCC, P.O. Box 12215, Research Triangle Park NC 27709; tel: 919/549-8141; fax: 919/549-8933; e-mail: orders@aatcc.org.

11.5 The test specimen may comprise (a) a single layer of the test fabric, (b) two layers of the test fabric, or (c) a combination of two different fabrics such as the outer fabric of a raincoat and the lining fabric.

11.6 A loose-fitting cap may be placed over the end of the spray nozzle to shut off the spray during the mounting or the removal of the specimen holder in the support frame.

Water Resistance: Impact Penetration Test

Developed in 1945 by AATCC Committee RA63; revised 1952, 2000; reaffirmed 1957, 1961, 1964, 1967, 1971, 1977, 1980, 1989; editorially revised and reaffirmed 1985, 1994; editorially revised 1986, 1987.

1. Purpose and Scope

1.1 This test method is applicable to any textile fabric, which may or may not have been given a water-resistant or water-repellent finish. It measures the resistance of fabrics to the penetration of water by impact, and thus can be used to predict the probable resistance of fabrics to rain penetration. It is especially suitable for measuring the penetration resistance of garment fabrics.

1.2 The results obtained with this test method depend on the water repellency of the fibers and yarns and on the construction and finish of the fabric.

2. Principle

2.1 A volume of water is allowed to spray against a taut surface of a test specimen backed by a weighed blotter. The blotter is then reweighed to determine water penetration and the specimen is classified accordingly.

3. Terminology

3.1 **water resistance**, n.—*of fabric*, the characteristic to resist wetting and penetration by water. (See also *water repellency*.)

4. Safety Precautions

NOTE: These safety precautions are for information purposes only. The precautions are ancillary to the testing procedures and are not intended to be all inclusive. It is the user's responsibility to use safe and proper techniques in handling materials in this test method. Manufacturers MUST be consulted for specific details such as material safety data sheets and other manufacturer's recommendations. All OSHA standards and rules must also be consulted and followed.

4.1 Good laboratory practices should be followed. Wear safety glasses in all laboratory areas.

5. Apparatus and Materials

- 5.1 Impact penetration testers
 - 5.1.1 Type I tester (see 11.1, Figs. 1, 3 and 4)
 - 5.1.2 Type II tester (see 11.1, Figs. 2, 3 and 4)
- 5.2 White AATCC Textile Blotting Paper (see 11.2)
- 5.3 Water, distilled, deionized or reverse osmosis
- 5.4 Balance accurate to 0.1 g

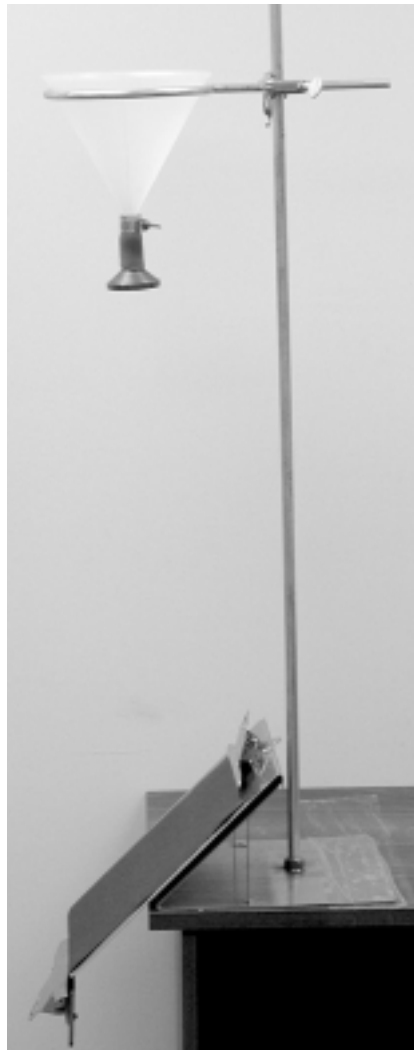

Fig. 1—Impact penetration Type I tester.

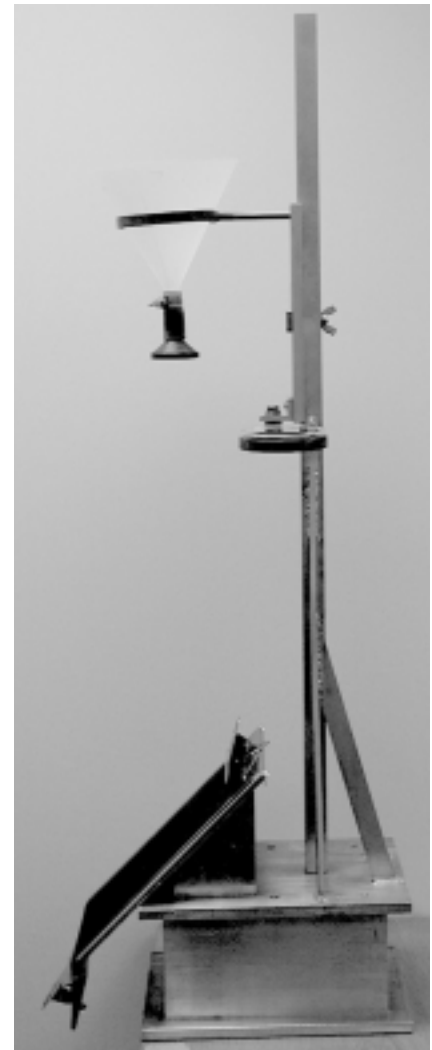

Fig. 2—Impact penetration Type II tester.

5.1.2 Type II tester (see 11.1, Figs. 2, 3 and 4)

5.2 White AATCC Textile Blotting Paper (see 11.2)

5.3 Water, distilled, deionized or reverse osmosis

5.4 Balance accurate to 0.1 g

6. Test Specimens

6.1 A minimum of three specimens are taken, each 178 × 330 mm, with the warp (machine direction of the fabric) in the long direction. The specimens and the blotting paper should be conditioned in an atmosphere of 65 ± 2% RH and 21 ± 1°C for at least 4 h before testing.

7. Procedure

7.1 One end of the specimen is clamped under the 152 mm spring clamp at the top of the inclined stand. Another 152 ± 10 mm clamp, of 0.4536 kg total mass, is clamped at the free end of the test specimen. A standard blotter paper 152 × 230 mm is weighed to the nearest 0.1 g and inserted beneath the test specimen.

7.2 A 500 ± 10 mL volume of distilled, deionized or reverse osmosis water at 27 ± 1°C is poured into a funnel of the tester and allowed to spray onto the test specimen. The water should be poured into the funnel without imparting any swirling motion of the water in the funnel. (A small blade fixed to the inside of the funnel and

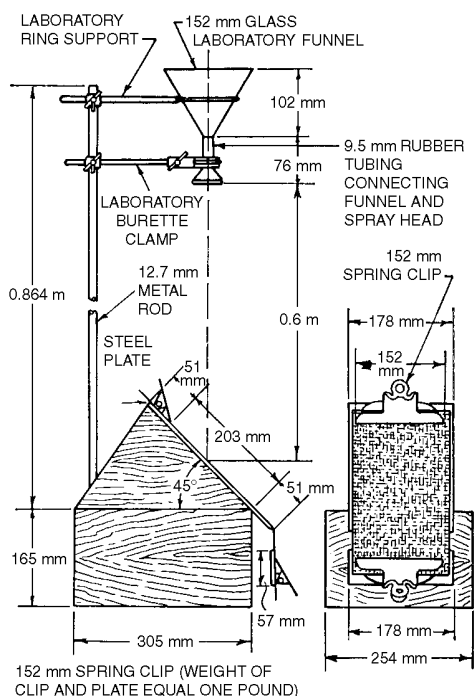

Fig. 3—Structural details of impact penetration tester.

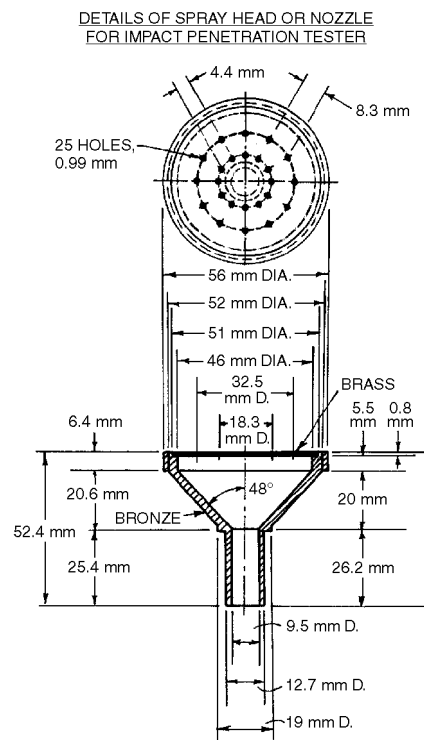

Fig. 4—Details of spray head.

extending down its side, will prevent any swirling motion from being initiated.)

7.3 Upon completion of the spraying period, the test specimen is carefully lifted, the blotter beneath removed, and then quickly reweighed to the nearest 0.1 g.

8. Evaluation

8.1 The increase in mass of the blotter in grams is calculated and the average result of the three test specimens is reported. Individual determinations or average values of over 5.0 g may be simply reported as + 5.0 g or > 5.0 g.

9. Report

9.1 Report the individual determinations and the average. For values of over 5.0 g simply report as + 5.0 g or > 5.0 g.

9.2 Report the test method number and which piece of equipment was used.

10. Precision and Bias

10.1 *Precision.* In 1998, a limited intralaboratory study was completed. The same operator tested all samples.

10.1.2 Three sets of fabrics were analyzed using both pieces of equipment. Each fabric was evaluated 15 times and averages calculated for each group of three. This single laboratory data set was analyzed and used in writing a temporary precision statement, pending a full interlaboratory study. Until a full study is completed, users of the method are advised to

exercise conventional statistical caution in making any comparisons of test results and apply these findings with due caution.

10.1.3 Variances ranged in value from 0.1-0.4 with an average value of 0.23 (standard deviation = 0.48) for the Type I tester, as determined by analysis of variance. Critical differences, based on these values and a 95% probability level, may be applied to determine significance (see Table I).

10.1.4 Variances ranged in value from 0.0-0.1 with an average value of 0.01 (standard deviation = 0.10) for the Type II tester, as determined by analysis of variance. Critical differences, based on these values and a 95% probability level, may be applied to determine significance (see Table II).

10.2 *Bias.* The values derived by this procedure can be defined only in terms of

a test method. There is no independent, referee method for determining the true value. This test method has no known bias.

11. Notes

11.1 Impact Penetration Testers (see Figs. 1, 2, 3 and 4). These testers, Types I and II, are a combination of the spray test apparatus used in AATCC Method 22, plus the impact penetration head and stand. The Type II tester is a more sturdy version of the Type I tester with the addition of a drip catcher. Both these testers are available from AATCC, P.O. Box 12215, Research Triangle Park NC 27709; tel: 919/549-8141; fax: 919/549-8933; e-mail: orders@aatcc.org.

11.2 Blotters suitable for this test can be obtained from AATCC, P.O. Box 12215, Research Triangle Park NC 27709; tel: 919/549-8141; fax: 919/549-8933; e-mail: orders@aatcc.org.

Table I—Within-Laboratory Critical Differences

Type I Tester—95% Probability Level

Det in Avg (N)	Standard Error	Critical Differences
1	0.48	1.11
3	0.28	0.64
5	0.21	0.50
7	0.18	0.41

N = Number of determinations per average
SE = Standard Error for N determinations
CD = 2.306 SE

Table II—Within-Laboratory Critical Differences

Type II Tester—95% Probability Level

Det in Avg (N)	Standard Error	Critical Differences
1	0.17	0.40
3	0.10	0.23
5	0.08	0.18
7	0.07	0.15

N = Number of determinations per average
SE = Standard Error for N determinations
CD = 2.306 SE

Wetting Agents for Mercerization

Developed in 1941 by AATCC Committee RA8; jurisdiction transferred in 2003 to AATCC Committee RA63; revised 1945, 1952; reaffirmed 1971, 1974, 1977, 1980, 1985, 1989, 1999; editorially revised 1986, 1991; editorially revised and reaffirmed 1994, 2004. Related to ISO 6836.

1. Purpose and Scope

1.1 This test method is applicable only to the evaluation of wetting agents in caustic soda of mercerizing concentration.

2. Principle

2.1 A 25 mm (1 in.) long bundle of cotton yarns composed of 120 ends is carefully dropped onto the surface of a test solution and the time for complete wetting of all ends is determined.

3. Terminology

3.1 **mercerization**, *n.*—a process for irreversibly altering the physical characteristics and appearance of natural cellulose fibers by swelling in strong alkali.

3.2 **wetting agent**, *n.*—a chemical compound which when added to water lowers both the surface tension of the liquid and its interfacial tension against the solid material.

4. Safety Precautions

NOTE: These safety precautions are for information purposes only. The precautions are ancillary to the testing procedures and are not intended to be all inclusive. It is the user's responsibility to use safe and proper techniques in handling materials in this test method. Manufacturers MUST be consulted for specific details such as material safety data sheets and other manufacturer's recommendations. All OSHA standards and rules must also be consulted and followed.

4.1 Good laboratory practices should be followed. Wear safety glasses in all laboratory areas.

4.2 All chemicals should be handled with care. Use chemical goggles or face shield, impervious gloves and an impervious apron during dispensing and mixing of sodium hydroxide.

4.3 An eyewash/safety shower should be located nearby and a self-contained breathing apparatus should be readily available for emergency use.

4.4 Exposure to chemicals used in this procedure must be controlled at or below levels set by governmental authorities (e.g., Occupational Safety and Health Adminis-

tration's [OSHA] permissible exposure limits [PEL] as found in 29 CFR 1910.1000 of January 1, 1989). In addition, the American Conference of Governmental Industrial Hygienists (ACGIH) Threshold Limit Values (TLVs) comprised of time weighted averages (TLV-TWA), short term exposure limits (TLV-STEL) and ceiling limits (TLV-C) are recommended as a general guide for air contaminant exposure which should be met (see 9.2).

5. Apparatus and Materials

5.1 Beakers, 250 mL.

5.2 Mohr measuring pipettes (0.1 graduation), 1 or 2 mL.

5.3 Volumetric transfer pipettes, 100 mL.

5.4 Stopwatch.

5.5 Scissors.

5.6 Ruler.

5.7 Cotton yarn, greige (unboiled), 40/2 combed *peeler*, preferably in form of chain warp or skein (see 9.1).

5.8 Standard mercerizing penetrant against which comparisons can be made.

5.9 Mercerizing caustic soda with a specific gravity of 48-52% Tw (271-299 g NaOH per liter of soln). Allow to stand several hours (until clear) after preparation.

5.10 Log-log coordinate paper No. 46-7083 from Keuffel & Esser Co., or No. 340-L21 from Eugene Dietzgen Co.

6. Procedure

6.1 Into each of three 250 mL beakers measure out 100 mL of the mercerizing caustic soda solution at $26 \pm 3^\circ\text{C}$ ($78 \pm 5^\circ\text{F}$). Pipette into one beaker 0.75 mL, into the next 1.00 mL and into the third beaker 1.25 mL of the mercerizing penetrant using a suitable small pipette. Mercerizing wetting agents all seem to be liquids. Stir the contents of each beaker until the penetrant is completely dissolved in the caustic soda. These solutions are allowed to stand until all air bubbles have risen to the surface. It should be particularly noticed if the penetrant remains well dispersed or dissolved because the separation of an immiscible layer on the surface would entirely vitiate the results and give false values.

6.2 From the greige (unboiled), 40/2, combed *peeler* cotton yarn, cut a bundle of 120 parallel ends, 25 mm (1 in.) in length. This bundle of yarn ends is dropped carefully onto the surface of one of the caustic solutions of penetrant, and the time required for complete wetting of all the ends is noted with a stopwatch. The average of five determinations is taken as the sinking time for that concentration.

6.3 In like manner the average sinking time is determined at the other two concentrations for the penetrant under test. Then the average sinking times for the standard at the same three concentrations are determined by the same procedure.

7. Evaluation

7.1 The three average sinking times to the nearest tenth second for the product under test and for the standard are plotted as ordinates on log-log coordinate paper against concentrations of wetting agent in milliliters per 100 mL of caustic soda solution. Straight lines should be obtained when the points are joined.

7.2 The number of milliliters of product under test which are required to give the same wetting time as 1 mL of standard is read from the plot. If the product is either too efficient or too inefficient to obtain a comparison within the range of the volumes already employed, then either a smaller (0.5 mL) or a larger (2.0 or 2.5 mL) volume of the product must be tested. Making the assumption that the standard and the product are reasonably the same in specific gravity, the same wetting effect as 100 parts of standard is obtained from the following formula:

$$x = 100 v$$

where:

x = parts of product being tested which are equivalent to 100 parts of standard and

v = volume of product in milliliter to give same wetting times as 1 mL of standard.

8. Precision and Bias

8.1 *Precision.* Precision for this test method has not been established. Until a precision statement is generated for this test method, use standard statistical techniques in making any comparisons of test results for either *within-laboratory* or *between-laboratory* averages.

8.2 *Bias.* Wetting agents for mercerization can be defined only in terms of a test method. There is no independent method for determining the true value. As a means of estimating this property, the method has no known bias.

9. Notes

9.1 Available from Testfabrics Inc., P.O. Box 26, 415 Delaware St., W. Pittston PA 18643; tel: 570/603-0432; fax: 570/603-0433; e-mail: testfabric@aol.com.

9.2 Available from Publications Office, ACGIH, Kemper Woods Center, 1330 Kemper Meadow Dr., Cincinnati OH 45240; tel: 513/742-2020.

Colorfastness to Laundering, Home and Commercial: Accelerated

Developed in 1950 by AATCC Committee RA60; revised 1952, 1954, 1957, 1960, 1961, 1970, 1972, 1986 (title change), 1989, 1993, 1994, 1996, 2003; reaffirmed 1956, 1962, 1965, 1968, 1969, 1975, 1980, 1985; editorially revised 1973, 1974, 1975, 1976, 1981, 1983, 1984, 1991, 1995, 1998, 2002, 2004; editorially revised and reaffirmed 2001. Partly equivalent to ISO 105-C06.

1. Purpose and Scope

1.1 These accelerated laundering tests are to evaluate the colorfastness to laundering of textiles which are expected to withstand frequent laundering. The fabric color loss and surface changes resulting from detergent solution and abrasive action of five typical hand, home or commercial launderings, with or without chlorine, are roughly approximated by one 45 min test (see 9.2-9.6). However, the staining effect produced by five typical hand, home or commercial launderings cannot always be predicted by the 45 min test. Staining is a function of the ratio of colored to undyed fabrics, fiber content of fabrics in the wash load and other end-use conditions which are not always predictable.

2. Principle

2.1 Specimens are tested under appropriate conditions of temperature, detergent solution, bleaching and abrasive action such that the color change is similar to that occurring in five hand, home or commercial launderings. The color change is obtained in a conveniently short time. The abrasive action is a result of the frictional effects of fabric against canister, the low liquor ratio and the impact of the steel balls on the fabric.

3. Terminology

3.1 **colorfastness**, *n.*—the resistance of a material to change in any of its color characteristics, to transfer of its colorant(s) to adjacent materials or both, as a result of the exposure of the material to any environment that might be encountered during the processing, testing, storage or use of the material.

3.2 **laundering**, *n.*—of *textile materials*, a process intended to remove soils and/or stains by treatment (washing) with an aqueous detergent solution and normally including subsequent rinsing, extracting and drying.

4. Safety Precautions

NOTE: These safety precautions are for information purposes only. The precautions are ancillary to the testing procedures and are not intended to be all inclusive. It is the user's responsibility to use safe and proper techniques in handling materials in the test method. Manufacturers MUST be consulted for specific details such as material safety data sheets and other manufacturer's recommendations. All OSHA standards and rules must also be consulted and followed.

4.1 Good laboratory practices should be followed. Wear safety glasses in all laboratory areas.

4.2 All chemicals should be handled with care.

4.3 The 1993 AATCC Standard Reference Detergent WOB may cause irritation. Care should be taken to prevent exposure to skin and eyes.

4.4 An eyewash/safety shower should be located nearby for emergency use.

4.5 Manufacturer's safety recommendations should be followed when operating laboratory testing equipment.

5. Apparatus, Reagents and Materials

5.1 Launder-Ometer.

5.1.1 A laundering machine for rotating closed canisters in a thermostatically controlled water bath at 40 ± 2 rpm (see 12.1).

5.1.2 Stainless steel lever lock canisters Type 1 (see 12.1) 500 mL (1 pt), 75×125 mm (3.0×5.0 in.) for Test No. 1A.

5.1.3 Stainless steel lever lock canisters Type 2 (see 12.1) 1200 mL, 90×200 mm (3.5×8.0 in.) for Tests No. 2A, 3A, 4A and 5A.

5.1.4 Adapter plates for holding canisters (see 5.1.3) on laundering machine shaft (see 12.1).

5.1.5 Stainless steel balls, 6 mm (0.25 in.) in diameter (see 12.1).

5.1.6 Teflon fluorocarbon gaskets (see 7.4.2, 12.1 and 12.2).

5.1.7 Preheater/storage module (see 7.4, 12.1 and 12.3).

5.2 Scales for rating test results.

5.2.1 AATCC Chromatic Transference Scale (see 12.4).

5.2.2 Gray Scale for Color Change (see 12.4).

5.2.3 Gray Scale for Staining (see 12.4).

5.3 Reagents and materials.

5.3.1 Multifiber test fabrics No. 1 and FB (8 mm [0.33 in.] bands) contains bands of acetate, cotton, nylon, silk, vis-

cose rayon and wool. Multifiber test fabrics No. 10, and FA (8 mm [0.33 in.] bands) and No. 10A and FAA (15 mm [0.6 in.] bands) contain bands of acetate, cotton, nylon, polyester, acrylic and wool (see 12.5).

5.3.2 Bleached cotton test fabric, 32×32 ends \times picks/cm (80×80 ends \times picks/in.) construction, 100 ± 3 g/m², de-sized without fluorescent whitening agent (see 12.5).

5.3.3 1993 AATCC Standard Reference Detergent WOB (without fluorescent whitening agent and without phosphate) (see 10.5 and 12.6).

5.3.4 1993 AATCC Standard Reference Detergent (with fluorescent whitening agent) (see 10.5 and 12.6).

5.3.5 Water, distilled or deionized (see 12.7).

5.3.6 Sodium hypochlorite (NaOCl) bleach (see 12.8).

5.3.7 Sodium carbonate (Na₂CO₃).

5.3.8 Sulfuric acid (H₂SO₄), 10% (see 12.8.1).

5.3.9 Potassium iodide (KI), 10% (see 12.8.1).

5.3.10 Sodium thiosulfate (Na₂S₂O₃), 0.1N (see 12.8.1).

5.3.11 Crockmeter test cloth cut in 50 mm (2 in.) squares (see 12.9).

5.3.12 White cards (specimen mounts) with *Y* tristimulus value at least 85%.

6. Test Specimens

6.1 The sizes of the specimens required for the various tests are as follows:

50 \times 100 mm (2.0 \times 4.0 in.) for Test No. 1A,

50 \times 150 mm (2.0 \times 6.0 in.) for Tests No. 2A, 3A, 4A and 5A.

6.2 Test only one specimen in each canister.

6.2.1 Test one specimen per laboratory sample. Replication may be advisable for improved precision.

6.3 To determine staining in Tests No. 1A and 2A, use multifiber test fabric. To determine staining in Test No. 3A, use either multifiber test fabric or bleached cotton test fabric. With respect to Test No. 3A, the use of multifiber test fabric is optional but the staining of acetate, nylon, polyester and acrylic is disregarded unless one of these fibers is present in the fabric being tested or known to be in the final garment. For Test 3A, multifiber test fabric with heat-sealed edges is recommended. Staining is not determined in Tests No. 4A and 5A (see 12.10 and 12.11).

6.4 Specimen preparation.

6.4.1 Preparation with multifiber test

fabric with individual component bands 8 mm (0.33 in.) wide or with bleached cotton test fabric. Prepare pieces with a 50 mm (2.0 in.) square of multifiber test fabric cloth or bleached cotton test fabric (as required) sewn, stapled or suitably attached along one 50 mm (2.0 in.) edge of the test specimen and in contact with the face of the material. When multifiber test fabric is used, attach it so that each of the six fiber bands is along the 50 mm (2.0 in.) edge of the specimen with the wool on the right. The fiber bands in the multifiber test fabric will be parallel to the lengthwise direction of the test specimen.

6.4.2 Preparation with multifiber test fabric with individual component bands 15 mm (0.6 in.) wide. Prepare pieces with a 50 × 100 mm (2.0 × 4.0 in.) rectangle of multifiber test fabric sewn, stapled or suitably attached centered along one 100 mm (4.0 in.) or 150 mm (6.0 in.) edge of the test specimen and in contact with the face of the material. Attach it so that each of the six fiber bands will be parallel to the widthwise direction of the specimen. Attach and secure the wool band at the top of the specimen to avoid fiber loss.

6.4.3 It is recommended that knitted fabrics be sewn or stapled at the four edges to equivalent size pieces of bleached cotton test fabric to avoid rolled edges and to assist in obtaining a uniform test result over the entire surface. Attach the multifiber test fabric to the face of the knitted fabric.

6.4.4 For pile fabric specimens with a pile lay direction, attach the multifiber test fabric at the top of the specimen with the pile lay direction pointing away from the top of the specimen.

6.5 When the textile to be tested is yarn, specimens may be tested using Option 1 or Option 2.

6.5.1 Option 1. Knit yarn on an appropriate sample knitting machine. Prepare specimens and multifiber test fabrics according to 6.1-6.4.3. Keep one knitted specimen of each sample as an unwashed original.

6.5.2 Option 2. Prepare two 110 m (120 yd) skeins of each yarn. Fold the skein so that there is a uniform amount of yarn across a 50 mm (2 in.) width with a length appropriate for the procedure to be used. Keep one skein of each sample as an unwashed original. Sew or staple Crockmeter test cloth squares (see 12.9) or squares of bleached cotton test fabric having approximately the same weight folded over each end of the layered yarn specimen. Attach a multifiber test fabric according to 6.4.1 or 6.4.2.

7. Procedure

7.1 Table I summarizes the conditions of the tests.

7.2 Adjust the laundering machine to maintain the designated bath tempera-

Table I—Test Conditions^a

Test No.	Temp		Total Liquor Volume	Percent Detergent of Total Volume	Available Chlorine of Total Volume	No. Steel Balls	Time
	°C (± 2)	°F (± 4)					
1A	40	105	200 mL	0.37%	None	10	45 Min
2A	49	120	150	0.15	None	50	45
3A	71	160	50	0.15	None	100	45
4A	71	160	50	0.15	0.015%	100	45
5A	49	120	150	0.15	0.027	50	45

^aRefer to Section 9 for objectives for each test method.

ture. Prepare the required volume of wash liquor. Preheat this solution to the prescribed temperature.

7.3 Run Test No. 1A in 75 × 125 mm (3.0 × 5.0 in.) lever lock stainless steel canisters. Run Tests No. 2A, 3A, 4A and 5A in 90 × 200 mm (3.5 × 8.0 in.) lever lock stainless steel canisters.

7.3.1 For Tests No. 1A, 2A and 3A, add to the canister the amount of detergent solution designated in Table I.

7.3.2 For Test No. 4A, prepare a 1500 ppm available chlorine solution. For 1 L, determine the amount of stock sodium hypochlorite bleach solution (see 12.8) to dilute as follows:

$$159.4/\% \text{ NaOCl} = \text{g to add}$$

Weigh the correct amount of bleach into a volumetric flask and dilute to 1 L. To each canister, add 5 mL of 1500 ppm available chlorine solution and 45 mL of detergent solution making a total volume of 50 mL.

7.3.3 For Test No. 5A, determine the amount of stock sodium hypochlorite bleach solution (see 12.8) to dilute as follows:

$$4.54/\% \text{ NaOCl} = \text{g to add}$$

Weigh the correct amount of bleach into a graduated cylinder and add detergent solution to make a total volume of 150 mL. Prepare this solution separately for each canister.

7.3.4 For all the tests, add the designated number of stainless steel balls to each canister.

7.4 The two options for preheating the canisters to the test temperature are by use of the laundering machine or the pre-heater/storage unit. If the canisters are to be preheated in the laundering machine, proceed to 7.4.2.

7.4.1 Place the canisters in the pre-heater module at the prescribed test temperature. They are to remain in the module for at least 2 min. Enter a well crumpled test specimen into each canister.

7.4.2 Clamp the covers on the canisters. A Teflon fluorocarbon gasket (see 5.1.6) may be inserted between the neoprene gasket and the top of each canister to prevent contamination of the wash solution by the neoprene. Fasten the 75 × 125 mm (3.0 × 5.0 in.) lever lock canis-

ters vertically and the 90 × 200 mm (3.5 × 8.0 in.) lever lock canisters horizontally in the adapters on the rotor of the laundering machine in such a manner that when the canisters rotate, the covers strike the water first. Place an equal number of canisters on each side of the shaft. For canisters preheated in the module, proceed to 7.7.

7.5 Start the rotor and run it for at least 2 min to preheat the canisters.

7.6 Stop the rotor and with a row of canisters in an upright position, unclamp the cover of one canister, enter a well crumpled test specimen into the solution and replace the cover, but do not clamp it. Repeat this operation until all the canisters in the row have been loaded. Then clamp the covers in the same order in which the canisters were loaded (delay clamping the covers to allow equalization of pressure). Repeat this operation until all rows of canisters have been loaded.

7.7 Start the laundering machine and run it at 40 ± 2 rpm for 45 min.

7.8 The rinsing, extracting and drying procedures are the same for all the tests. Stop the machine, remove the canisters and empty the contents into beakers, keeping each test specimen in a separate beaker. Rinse each test specimen three times, in beakers, in distilled or deionized water at 40 ± 3°C (105 ± 5°F) for 1 min periods with occasional stirring or hand squeezing. To remove excess water, centrifuge, blot or pass the test specimens through wringer rolls. Dry the specimens in an air circulating oven in which the temperature does not exceed 71°C (160°F), or tumble dry in a nylon mesh bag in an automatic tumble dryer at normal cycle, which has an exhaust temperature of 60-71°C (140-160°F), or air dry.

7.9 Allow specimens to condition at 65 ± 2% relative humidity and 21 ± 1°C (70 ± 2°F) for 1 h before evaluating.

7.10 Prepare tested fabric specimens and adjacent fabrics for evaluation by trimming off raveled yarns and lightly brushing off any loose fiber and yarn on the fabric surfaces. Brush pile fabric specimens in required direction to restore them as nearly as possible to the same pile angle as the untreated specimens. Specimens should be smoothed or flat-

tened if they are wrinkled and messy due to washing and/or drying. Specimens may be mounted on cards to facilitate identification and handling in their evaluation. For consistency in backing material, use a white mounting card with *Y* tristimulus value of at least 85%. Mounting material must not be visible in the area to be viewed and must not interfere with rating as specified in 5.1 of both Evaluation Procedures 1 and 2 for the Gray Scale for Color Change and Gray Scale for Staining or instrumental assessment of color according to AATCC Evaluation Procedure 7, Instrumental Assessment of the Change in Color of a Test Specimen.

7.10.1 Yarn skein specimens should be combed and brushed for improved alignment of the yarns before comparison with the unwashed original. The original specimens may also need further combing and brushing for uniformity of appearance.

8. Evaluation

8.1 Evaluation of color change.

8.1.1 Evaluate the color change of the test specimens as directed in Evaluation Procedure 1 using the Gray Scale for Color Change. For improved precision and accuracy the specimens should be rated by more than one rater.

Grade 5—negligible or no change as shown in Gray Scale Step 5.

Grade 4.5—change in color equivalent to Gray Scale Step 4.5.

Grade 4—change in color equivalent to Gray Scale Step 4.

Grade 3.5—a change in color equivalent to Gray Scale Step 3.5.

Grade 3—change in color equivalent to Gray Scale Step 3.

Grade 2.5—change in color equivalent to Gray Scale Step 2.5.

Grade 2—change in color equivalent to Gray Scale Step 2.

Grade 1.5—change in color equivalent to Gray Scale Step 1.5.

Grade 1—change in color equivalent to Gray Scale Step 1.

8.1.2 The color change can be quantitatively determined by measuring the color difference between the unwashed sample and a test specimen using a suitable colorimeter or spectrophotometer with the appropriate software (see AATCC Evaluation Procedure 7, Instrumental Assessment of the Change in Color of a Test Specimen).

8.2 Evaluation of staining.

8.2.1 Evaluate staining (see 12.10) as directed in Evaluation Procedure 2 using the Gray Scale for Staining or as directed in Evaluation Procedure 8 using the Chromatic Transference Scale. The scale used should be indicated when reporting the test results.

Grade 5—negligible or no color transfer.

Grade 4.5—color transfer equivalent to

Step 4-5 on the Gray Scale for Staining or Row 4.5 on the 9-step AATCC Chromatic Transference Scale.

Grade 4—color transfer equivalent to Step 4 on the Gray Scale for Staining or Row 4 on the 9-step AATCC Chromatic Transference Scale.

Grade 3.5—color transfer equivalent to Step 3-4 on the Gray Scale for Staining or Row 3.5 on the 9-step AATCC Chromatic Transference Scale.

Grade 3—color transfer equivalent to Step 3 on the Gray Scale for Staining or Row 3 on the 9-step AATCC Chromatic Transference Scale.

Grade 2.5—color transfer equivalent to Step 2-3 on the Gray Scale for Staining or Row 2.5 on the 9-step AATCC Chromatic Transference Scale.

Grade 2—color transfer equivalent to Step 2 on the Gray Scale for Staining or Row 2 on the 9-step AATCC Chromatic Transference Scale.

Grade 1.5—color transfer equivalent to Step 1-2 on the Gray Scale for Staining or Row 1.5 on the 9-step AATCC Chromatic Transference Scale.

Grade 1—color transfer equivalent to Step 1 on the Gray Scale for Staining or Row 1 on the 9-step AATCC Chromatic Transference Scale.

8.2.2 The color transferred to the multifiber test fabric or bleached cotton test fabric square of 6.4.1 can be quantitatively determined by measuring the color difference between a piece of the original material and the stained material. Multifiber test fabrics No. 10A or FAA have bands of sufficient width to be within the aperture diameter capability of many colorimeters and spectrophotometers (see Evaluation Procedure 6, Instrumental Color Measurement and 12.14).

9. Interpretation of Results

9.1 Results from these tests are intended to approximate the color change effects (see 1.1) of five typical home or commercial launderings. These are accelerated tests, and in obtaining the required degree of acceleration some of the conditions, such as temperature, were purposely exaggerated. The tests have remained largely the same over many years while laundry detergents, washers and dryers, laundry practices and fabrics have changed (see monograph “*Standardization of Home Laundry Test Conditions*,” elsewhere in this TECHNICAL MANUAL). Consequently, caution in interpreting test results is advisable.

9.2 Test No. 1A—This test is for evaluating the colorfastness of textiles that are expected to withstand repeated hand laundering at low temperature. Specimens subjected to this test should show color change similar to that produced by five typical careful hand launderings at a

temperature of $40 \pm 3^\circ\text{C}$ ($105 \pm 5^\circ\text{F}$).

9.3 Test No. 2A—This test is for evaluating the colorfastness to washing of textiles that are expected to withstand repeated low temperature machine laundering in the home or in the commercial laundry. Specimens subjected to this test should show color change similar to that produced by five commercial launderings at $38 \pm 3^\circ\text{C}$ ($100 \pm 5^\circ\text{F}$) or by five home machine launderings at medium or warm setting in the temperature range of $38 \pm 3^\circ\text{C}$ ($100 \pm 5^\circ\text{F}$).

9.4 Test No. 3A—This test is for evaluating colorfastness to washing of textiles considered washable under vigorous conditions. Specimens subjected to this test should show color change similar to that produced by five commercial launderings at $49 \pm 3^\circ\text{C}$ ($120 \pm 5^\circ\text{F}$) or by five home machine launderings at $60 \pm 3^\circ\text{C}$ ($140 \pm 5^\circ\text{F}$), both without chlorine.

9.5 Test No. 4A—This test is for evaluating the colorfastness to washing of textiles laundered in the presence of available chlorine. Specimens subjected to this test should show color change similar to that produced by five commercial launderings at $71 \pm 3^\circ\text{C}$ ($160 \pm 5^\circ\text{F}$) with 1.9 L (2.0 qt) of 1% available chlorine per 45.4 kg (100.0 lb) of load (white wash formula) or by five home machine launderings at $63 \pm 3^\circ\text{C}$ ($145 \pm 5^\circ\text{F}$) with 3.74 g per L (0.50 oz/gal) of 5% available chlorine per 3.6 kg (8.0 lb) load.

9.6 Test No. 5A—This test is for evaluating the colorfastness to washing of textiles that may be laundered in the presence of available chlorine. Specimens subjected to this test should show color change similar to that produced by five home machine launderings at $49 \pm 3^\circ\text{C}$ ($120 \pm 5^\circ\text{F}$) with 200 ± 1 ppm available chlorine.

10. Report

10.1 Report the test number.

10.2 Report the grade number determined for color change in 8.1 and the staining grade numbers for the evaluated fibers in the multifiber test fabric and/or bleached cotton test fabric as determined in 8.2.

10.3 State which scale (Gray Scale for Staining or AATCC Chromatic Transference Scale) was used in evaluating staining (see 12.12).

10.4 Report the multifiber test fabric used and if bleached cotton test fabric was employed to avoid knit curling.

10.5 Report the detergent used with color change and staining results (see 12.6).

10.6 Report which laundering machine is used.

11. Precision and Bias

11.1 Precision and bias statements

have been developed for Tests No. 2A and 5A. Although correlation work has been done, no precision and bias statements have been developed for Tests No. 1A, 3A and 4A.

11.1.1 Because of changes in the detergents used in this method, these precision and bias statements may not apply to data or information obtained with the currently available detergents.

11.2 Test No. 2A.

11.2.1 *Summary.* An interlaboratory test was carried out in May 1985 to establish the precision of Test No. 2A. A part of the test was to determine if the wider 15 mm (0.6 in.) No. 10A multifiber test fabric could be substituted for the 8 mm (0.33 in.) wide No. 10. The complete test consisted of six laboratories evaluating 10 materials in duplicate by one operator using Test No. 2A.

11.2.2 *Color Change.* Three raters from six laboratories independently evaluated nine materials in duplicate using the Gray Scale for Color Change. The components of variance as standard deviations of the colorfastness grades (averages of variances for No. 10 and No. 10A multifiber test fabrics) were calculated as follows:

Single-Operator Component	0.29
Within-Laboratory Component	0.29
Between-Laboratory Component	0.29

11.2.3 *Critical Differences.* For the components of variance reported in 11.2.2, two averages of observed values should be considered significantly different at the 95% probability level if the difference is equal to or exceeds the critical differences shown in Table II.

Table II—Critical Differences, Grades, for the Condition Noted^a

No. of Observations	Single-Operator Precision	Within-Lab Precision	Between-Lab Precision
1	0.80	1.12	1.37
3	0.46	0.92	1.21
5	0.36	0.87	1.18

^aThe critical differences were calculated using $t = 1.950$ which is based on infinite degrees of freedom.

11.2.4 *Staining.* Three raters independently rated the six fibers of the multifiber test fabric (No. 10 and No. 10A) for 10 materials at six laboratories using the Gray Scale for Staining. Of the 60 possible fiber/fabric combinations, only 51 could be used. The components of variance were averaged for the No. 10 and No. 10A multifiber test fabrics and appear below as standard deviations of

staining ratings:

Single Operator Component	0.27
Within-Laboratory Component	0.34
Between-Laboratory Component	0.25

11.2.5 *Critical Differences.* For the components of variance reported in 11.2.4, two averages of observed values should be considered significantly different at the 95% probability level if the difference equals or exceeds the critical differences shown in Table III.

Table III—Critical Differences, Grades, for the Condition Noted^a

No. of Observations	Single-Operator Precision	Within-Lab Precision	Between-Lab Precision
1	0.75	1.20	1.39
3	0.43	1.03	1.25
5	0.33	1.00	1.22

^aThe critical differences were calculated using $t = 1.950$ which is based on infinite degrees of freedom.

11.2.6 *Bias.* Tests comparing five home launderings at 40°C (105°F) with one Launder-Ometer Test No. 2A indicate there is no bias between the two methods for the colorfastness and staining levels evaluated.

11.3 Test No. 5A, Chlorine Bleach.

11.3.1 *Summary.* An interlaboratory test was carried out in 1984 to establish the precision of Test No. 5A for determining the effect of chlorine bleach on the colorfastness of fabrics. All specimens were laundered in a Launder-Ometer by one operator. Color change in Test No. 5A was determined both visually and instrumentally. Details of the statistical analysis of the data can be found in the report, Third Interlaboratory Study of Proposed Launder-Ometer Test for Colorfastness of Fabrics to Chlorine and Non-Chlorine Bleaches, October 21, 1985, by J. W. Whitworth, Milliken Research Corp., Spartanburg, SC.

11.3.2 *Visual Assessment.* Four materials were tested at each of five laboratories. Three raters visually assessed the color change of four specimens. The components of variance as standard deviations of colorfastness grades were calculated as follows:

Single Operator Component	0.38
Within-Laboratory Component	0.28
Between-Laboratory Component	0.27

11.3.3 *Critical Differences.* For the components of variance in 11.3.2, two

averages of observed values should be considered significantly different at the 95% probability level if the difference equals or exceeds the critical differences shown in Table IV.

Table IV—Critical Differences, Grades, for the Condition Noted^a

No. of Observations	Single-Operator Precision	Within-Lab Precision	Between-Lab Precision
1	1.03	1.29	1.49
3	0.59	0.98	1.23
5	0.46	0.91	1.17

^aThe critical differences were calculated using $t = 1.950$ which is based on infinite degrees of freedom.

11.3.4 *Instrumental Assessment.* Color change as total color difference (CIELAB) was measured on a spectrophotometer or colorimeter using apertures ranging in size from 13-51 mm (0.5-2.0 in.) in diameter, illuminant D₆₅/10° observer or illuminant C/2° observer. Six materials were tested at each of six laboratories. One operator in each laboratory tested four specimens of each fabric. The components of variance for ΔE^* expressed as coefficients of variation were calculated to be:

Single-Operator Component	6.8%
Between-Laboratory Component	11.2%

11.3.5 *Critical Differences.* For the components of variance reported in 11.3.4, two averages of observed values should be considered significantly different at the 95% probability level if the difference equals or exceeds the critical differences shown in Table V.

Table V—Critical Differences, Percent of Grand Average for the Conditions Noted^{a,b}

No. of Observations in Each Average	Single-Operator Precision	Between-Laboratory Precision
1	18.7	36.2
3	10.8	32.8
5	8.4	32.1

^aThe critical differences were calculated using $t = 1.950$ which is based on infinite degrees of freedom.

^bTo convert the values of the critical differences to units of measure, multiply the critical differences by the average of the two specific sets of data being compared and then divide by 100.

11.3.6 *Bias.* Tests comparing five home launderings at 49°C (120°F) with one Launder-Ometer Test No. 5A indicate there is no bias between the two methods for the colorfastness levels evaluated (see 12.13).

12. Notes

12.1 The Launder-Ometer (a registered trademark of Atlas Electric Devices), is available with accessories from SDL Atlas L.L.C., 1813A Associate Lane, Charlotte NC 28217; tel: 704/329-0911; fax: 704/329-0914; e-mail: info@sdatlas.com.

12.2 Teflon is a registered trademark of the DuPont Co., Wilmington DE 19898.

12.3 The preheater/storage unit may be a side unit to the laundering machine or a separate module with its individual electric heater and thermostat to control water bath temperatures for heating containers and solutions prior to loading the laundering machine.

12.4 Available from AATCC, P.O. Box 12215, Research Triangle Park NC 27709; tel: 919/549-8141; fax: 919/549-8933; e-mail: orders@aatcc.org.

12.5 Multifiber test fabrics No. 1, No. 10 and No. 10A are available from Testfabrics Inc., P.O. Box 26, 415 Delaware St., W. Pittston PA 18643; tel: 570/603-0432; fax: 570/603-0433; e-mail: testfabric@aol.com. Multifiber test fabrics FA, FB and FAA are available from Textile Innovators Corp., div. of SDL Atlas L.L.C., P.O. Box 8, 101 Forest St., Windsor NC; tel: 252/794-9703; fax: 252/794-9704; e-mail: tic@sdatlas.com. Bleached cotton test fabric in 32 × 32 ends × picks/cm (80 × 80 ends × picks/in.) construction, 100 ± 3 g/m² and without fluorescent whitening agent is available from both suppliers.

12.6 The 1993 AATCC Standard Reference Detergent WOB (without fluorescent whitening agent), a compact formulation, is the primary detergent to be used in this test method. Where the effect of a fluorescent whitening

agent is to be evaluated, 1993 AATCC Standard Reference Detergent (with fluorescent whitening agent) should be used. Both detergents are available from AATCC, P.O. Box 12215, Research Triangle Park NC 27709; tel: 919/549-8141; fax: 919/549-8933; e-mail: orders@aatcc.org.

12.7 Use distilled water or deionized water of not more than 15 ppm hardness to dissolve the detergent and for the test solutions.

12.8 Use sodium hypochlorite bleach purchased within the last six months for a stock solution.

12.8.1 To confirm the stock solution's hypochlorite activity, weigh 2.00 g liquid sodium hypochlorite into an Erlenmeyer flask and dilute with 50 mL of deionized water. Add 10 mL of 10% sulfuric acid and 10 mL of 10% potassium iodide. Titrate with 0.1N sodium thiosulfate until colorless.

Calculation:

% sodium hypochlorite

$$= \frac{(\text{mL Na}_2\text{S}_2\text{O}_3)(0.1N)(0.03722)}{(2.00 \text{ g NaOCl})} \times 100$$

The factor 0.03722 is derived by multiplying the molecular weight of NaOCl (74.45 g/mol) by 0.001 (mL to L conversion) and dividing by 2 (mols of thiosulfate per hypochlorite).

12.8.2 Oxidizing power of sodium hypochlorite is typically expressed in terms of available chlorine, the equivalent amount of diatomic chlorine present. A 5.25% NaOCl solution contains 50,000 ppm available chlorine.

12.9 Crockmeter test cloth, 32 × 33 ends × picks/cm (80 × 84 ends × picks/cm) combed cotton, desized, bleached (no fluorescent whitenener or finishing material present) is available

from the following suppliers: Testfabrics Inc., P.O. Box 26, 415 Delaware St., W. Pittston PA 18643; tel: 570/603-0432; fax: 570/603-0433; e-mail: testfabric@aol.com; Textile Innovators Corp., div. of SDL Atlas L.L.C., P.O. Box 8, 101 Forest St., Windsor NC; tel: 252/794-9703; fax: 252/794-9704; e-mail: tic@sdatlas.com.

12.10 If staining evaluations are needed for Tests No. 4A and 5A, they may be carried out using the corresponding Tests No. 2A or 3A, which use no bleach. Test No. 2A is the no-bleach alternate for Test No. 5A, and Test No. 3A is the no-bleach alternate for Test No. 4A.

12.11 If multifiber test fabric is used in conjunction with Tests 4A or 5A, the wool can absorb the chlorine leaving very little for bleaching action. The wool may be removed from the multifiber test fabric before testing to eliminate this effect.

12.12 For very critical evaluations and in cases of arbitration, grades must be based on the geometric Gray Scale for Staining.

12.13 For additional information pertaining to the bias between Test No. 5A and five home washes, refer to Fig. 1 in Interlaboratory Study of Proposed Launder-Ometer Test for Colorfastness of Fabrics to Chlorine and Non-Chlorine Bleaches, Report to AATCC Committee RA60, Colorfastness to Washing Test Methods, November 1984, New York NY by L. B. Farmer and J. W. Whitworth of Milliken Research Corp., Spartanburg SC, and J. G. Tew, AATCC Technical Center, Research Triangle Park NC.

12.14 AATCC Evaluation Procedure 7 gives a method for computing Gray Scale grades from color measurement data.

Wrinkle Recovery of Woven Fabrics: Recovery Angle

Developed in 1951 by AATCC Committee RR6; jurisdiction transferred in 1995 to AATCC Committee RA61; revised 1952, 1953, 1956, 1959, 1998 (with title change); reaffirmed 1968, 1972, 1975, 1978, 1984, 1990, 2003; editorially revised 1986, 1991, 1995; reaffirmed and editorially revised 1996; Option 1, Partly equivalent to ISO 2313.

1. Purpose and Scope

1.1 This test method is used to determine the wrinkle recovery of woven fabrics. It is applicable to fabrics made from any fiber, or combination of fibers.

2. Principle

2.1 A test specimen is folded and compressed under controlled conditions of time and force to create a folded wrinkle. The test specimen is then suspended in a test instrument for a controlled recovery period, after which the recovery angle is recorded.

3. Terminology

3.1 **wrinkle recovery**, n.—that property of a fabric which enables it to recover from folding deformations.

4. Safety Precautions

NOTE: These safety precautions are for information purposes only. The precautions are ancillary to the testing procedures and are not intended to be all inclusive. It is the user's responsibility to use safe and proper techniques in handling materials in this test method. Manufacturers MUST be consulted for specific details such as material safety data sheets and other manufacturer's recommendations. All OSHA standards and rules must also be consulted and followed.

4.1 Good laboratory practices should be followed. Wear safety glasses in all laboratory areas.

5. Uses and Limitations

5.1 Two options for performing wrinkle recovery angle testing are included in this test method. The Option 1 procedure is applicable to equipment commercially available and similar to devices used in ISO 2313: Determination of the Recovery from Creasing of a Horizontally Folded Specimen by Measuring the Angle of Recovery (see 13.1). The Option 2

procedure is for those laboratories that still have the older recovery devices which are no longer available from their original source.

5.2 This method has been used as a research tool and for production quality control (see 13.2).

5.3 Parameters to be controlled in the test are: relative humidity, temperature, applied pressure, time under pressure, and recovery time. This method specifies arbitrary selected values for the latter three factors, based on a compromise between conditions likely to be encountered in service, and the expeditious conduct of the test. Two conditions of temperature and relative humidity are specified as being representative of normal experience. For specialized purposes, it may be advisable to use other combinations of temperature and humidity.

5.4 Specimens from limp or heavy weight fabrics may twist or curl making angle readings difficult to determine (see 13.3).

6. Apparatus

6.1 Wrinkle Recovery Tester and accessories, Option 1 (see Fig. 1, 13.4 and 13.5).

6.1.1 Loading device with two flat plates (see Fig. 2).

6.1.2 Wrinkle Recovery Circular Scale divided into degrees over the range 10–

180° (see Fig. 3).

6.1.3 Paper or aluminum foil not exceeding 0.04 mm thick.

6.2 Wrinkle Recovery Tester and accessories, Option 2 (see Fig. 4).

6.2.1 Disk and protractor with clamp mounted to the disk (see Fig. 4).

6.2.2 Specimen holder with two superimposed stainless steel leaves, 0.16 ± 0.01 mm thick, fastened together at one end. The top leaf is shorter than the bottom leaf.

6.2.3 Plastic press, consisting of two superimposed leaves 95 × 20 mm fastened together at one end. A 23 × 20 mm plastic section is attached to the outer surface of the free end of one leaf, flush with the outer edges that form a platform for a weight.

6.3 Tweezers with a jaw width of 25 mm and a line marked on both external faces 5 mm from the end and parallel to the jaw width (see Fig. 5). Another pair of tweezers, preferably plastic, is needed to handle specimens.

6.4 Clock or timer accurate to ± 1 s.

6.5 Template, 40 × 15 mm.

6.6 Weight, 500 ± 5 g.

6.7 Conditioning chamber suitable for the manipulation of the test specimen and the test apparatus that can produce atmospheres other than the standard atmosphere for testing textiles.

7. Test Specimens

7.1 Identify the face and back of the fabric sample. Avoid taking specimens from creased, wrinkled, or distorted sections of the sample.

7.2 Cut 12 specimens 40 × 15 mm, six with their long dimension parallel to the warp direction of the fabric and six with their long dimension parallel to the filling direction.

7.2.1 Cut warp specimens from sample locations with different warp yarns. Cut filling specimens from sample locations with different filling yarns (see Fig. 6). Unless otherwise specified, take specimens no nearer the selvage or edge of the fabric than one tenth the width of the fabric.

7.3 Mark the fabric face of each specimen.

7.4 Avoid handling or distorting the specimens. The use of a template or die for cutting the specimens and tweezers for handling them is recommended.



Fig. 1—Option 1—Wrinkle Recovery Angle Tester and accessories.

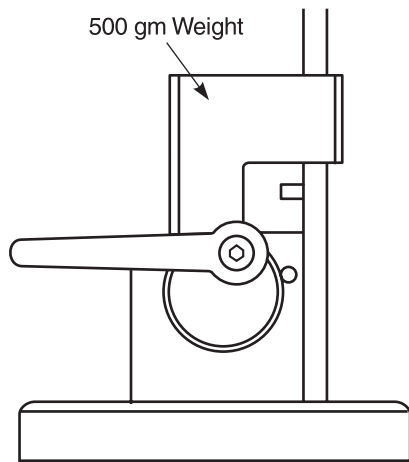

Fig. 2—Option 1—Loading device.

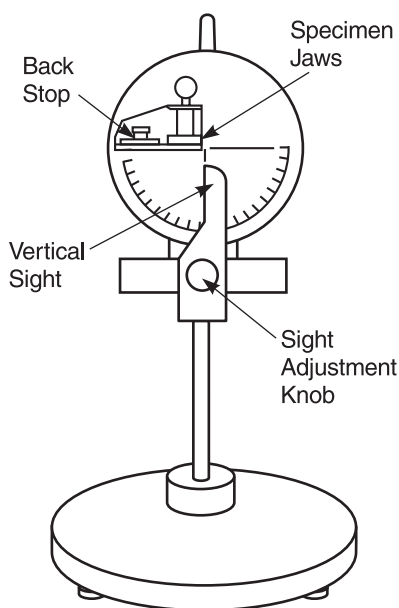

Fig. 3—Option 1—Wrinkle Recovery Angle Tester.



Fig. 4—Option 2—Wrinkle Recovery Tester and accessories

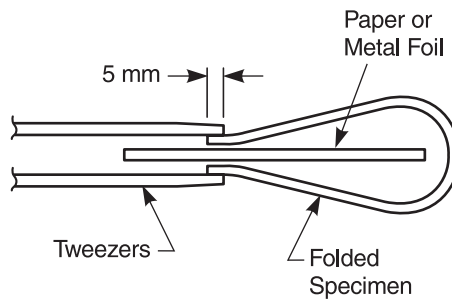

Fig. 5—Option 1—Folding of specimen.

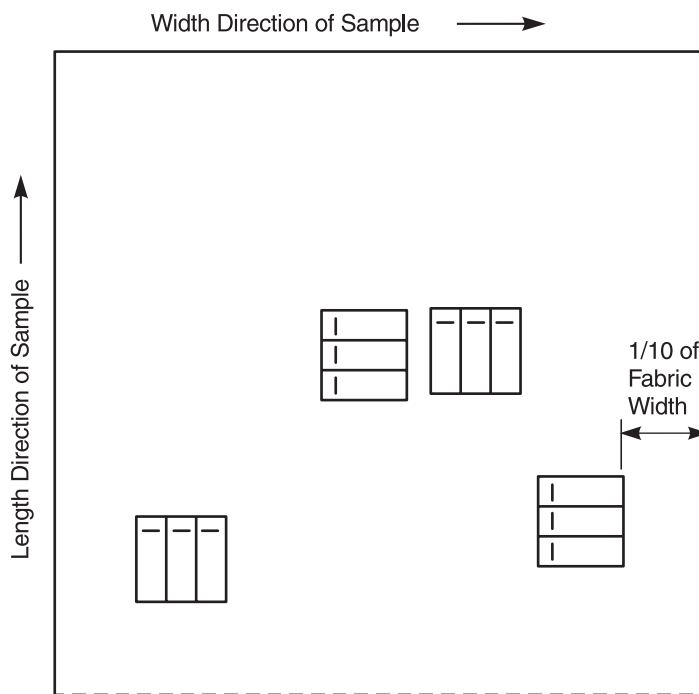

Fig. 6— Specimen sampling layout.

8. Conditioning

8.1 Lay specimens flat to condition at $65 \pm 2\%$ RH, $21 \pm 1^\circ\text{C}$ ($70 \pm 2^\circ\text{F}$) for at least 24 h prior to testing. Shorter conditioning periods which still allow attainment of equilibrium moisture content are acceptable.

8.2 If other atmospheres are used, they should be reported with the test results (see 11.3). For example, high humidity determinations may be made after conditioning samples at $35 \pm 1^\circ\text{C}$ ($95 \pm 2^\circ\text{F}$), $90 \pm 2\%$ RH for 24 h prior to testing.

9. Procedure

9.1 Option 1.

9.1.1 Three sets of loading devices, crease recovery scales and weights can be used to test three specimens sequentially, one after another every 60 s.

9.1.2 Fold a face-to-face specimen end-to-end and hold it in this position

with tweezers, gripping no more than 5 mm from the ends. In instances where the surfaces of the specimens show a tendency to stick together, place a piece of paper or aluminum foil, 18×14 mm, between the ends of the specimen (see Fig. 5). Avoid touching the specimen with anything other than the tweezers.

9.1.3 Place the folded specimen between the two leaves of the loading device and immediately apply the weight. Start a timing device. Wait 60 ± 2 s to repeat steps 9.1.2 and 9.1.3 for the next specimen. Wait another 60 ± 2 s to start the third specimen's load timing.

9.1.4 After $5 \text{ min} \pm 5 \text{ s}$, quickly but smoothly, remove the weight from the first specimen so that the specimen press does not spring open.

9.1.5 Using tweezers, transfer the folded specimen to the instrument's circular scale specimen holder. If paper or foil was used, remove it at this time. In-

sert one end of the specimen between the clamp on the specimen holder, leaving the other end to hang freely. Avoid disturbing the folded formation by placing the specimen no farther into the clamp than the back stop. Start timing the recovery period. Wait 60 ± 2 s, sequentially, to load the second and third specimens in holders.

9.1.6 While the specimen is in the holder, adjust the instrument to keep the free hanging end of the specimen in alignment with the vertical mark. Frequent adjustment during the 5 min time period is necessary to avoid gravitational effects.

9.1.7 Read and record the recovery angle from the circular scale $5 \text{ min} \pm 5 \text{ s}$ after inserting a specimen into a clamp. If the free end of the specimen twists, sight a vertical plane through its center and align it with the vertical mark on the circular scale. Read and record the recovery angle for each specimen after $5 \text{ min} \pm 5 \text{ s}$ after inserting it into a clamp.

9.1.8 Repeat all steps for three specimens in the opposite direction and for specimens to be folded face-to-back in both fabric directions.

9.2 Option 2.

9.2.1 Using tweezers, place a specimen between the leaves of the metal holder with one end aligned under the 18 mm mark. With the tweezers, lift the free end of the specimen up and over to the 18 mm mark taking care to loop back rather than flatten the specimen. Hold the edge of the specimen firmly in place with a thumbnail.

9.2.2 Still holding the specimen end with a thumbnail, open the jaws of a plastic press with the other hand. Insert the holder with the specimen between the long and short jaws, releasing the thumbnail when bringing the end edge of the long jaw into contact with the specimen. The 18 mm mark on the metal holder, the unfolded end of the specimen, and the end edge of the plastic press are to be aligned before releasing the specimen. A fold should be formed 1.5 mm from the end of the short metal leaf. The plastic press should be in firm contact with the folded specimen but should not be squeezed.

9.2.3 Invert the press-holder combination on a flat surface with the small platform up. Gently apply a weight to the platform. Start a timing device. Repeat steps 9.2.1 through 9.2.3 for a second specimen after 60 ± 2 s has lapsed. After 60 ± 2 additional s, repeat all steps for the third specimen.

9.2.4 After $5 \text{ min} \pm 5 \text{ s}$, remove the weight. Pick up the press-holder combination by the plastic press and insert the exposed end of the specimen holder in the clip mount on the face of the recorder device. Open the jaws and remove the

press rapidly taking care to avoid rolling the exposed end of the specimen or pulling it out of the holder.

9.2.4.1 Align the holder with the front edge of the clip mount shelf. The specimen fold should line up with the spot at the center of the recorder disk leaving the free hanging leg of the specimen aligned with the vertical guide line on the scale. Take special care to not touch, blow on or jam the specimen against the face of the recorder. Perform all operations as rapidly as possible. Repeat steps 9.2.4 and 9.2.4.1 for the second specimen, starting 60 ± 2 s after the weight is removed from the first specimen. Repeat all steps for the third specimen, 60 ± 2 s after the weight was removed from the second specimen.

9.2.4.2 To eliminate gravitational effects, keep the free hanging leg of the specimen aligned with the recorder's vertical guide line during the $5 \text{ min} \pm 5 \text{ s}$ recovery period. Adjust every $15 \pm 1 \text{ s}$ for the first minute, and once a minute thereafter during the remaining recovery period. Make the final adjustment $15 \pm 1 \text{ s}$ before the $5 \text{ min} \pm 5 \text{ s}$ recovery period ends. A procedure to run continuous specimen testing is given in 13.6.

9.2.5 Read and record the recovery angle from the scale $5 \text{ min} \pm 5 \text{ s}$ after inserting a specimen into the clip mount on the recorder. If the free end of a specimen twists, sight a vertical plane through its center and align it with the vertical mark on the recorder scale. Read and record the recovery angle for each specimen after it has been inserted in the clip mount for $5 \text{ min} \pm 5 \text{ s}$.

9.2.6 Repeat all steps for three specimens in the opposite direction and for specimens folded face-to-back in both fabric directions.

10. Calculation

10.1 Calculate the average recovery in degrees for each group of three specimens; warp folded face-to-face; warp folded back-to-back; filling folded face-to-face; and filling folded back-to-back.

10.2 If the difference between face-to-face and back-to-back averages is not greater than 15° , average all warp readings and all filling readings separately. If the difference between face-to-face and back-to-back averages is greater than 15° , report the four averages separately.

11. Report

11.1 State that the tests were performed as directed in AATCC Method 66, Option 1 or Option 2.

11.2 Report the average warp and filling (or when necessary warp-face, warp-back, filling-face and filling-back) recovery angles.

11.3 If other testing atmospheres are used, report the conditions under which the test was performed with the average values.

12. Precision and Bias

12.1 Precision.

12.1.1 In 1996, a single laboratory study was run comparing Option 1 to Option 2. Five face-to-face determinations were made for warp and filling specimens for six fabrics. The study showed either option to give similar and satisfactory test results.

12.1.2 Using this study as a basis, a provisional *within-laboratory* precision statement is included for guidance of users of the test method. The range of variance values for the data set was 1 to 58 (degree squared) for warp specimens and 1 to 21 for filling specimens. Users of the method should use standard statistical techniques in making any comparisons of either *within-laboratory* or *between-laboratory* averages.

12.1.3 Provisional *within-laboratory* precision (see Table I).

12.1.4 An ISO interlaboratory was performed in 1988 (see 13.7).

12.2 Bias.

12.2.1 Wrinkle recovery angle can be defined only in terms of a test method. There is no independent referee method for determining the true value of this property. This method has no known bias.

13. Notes

13.1 ISO 2313: Determination of the Recovery from Creasing of a Horizontally Folded Specimen by Measuring the Angle Recovery, may be obtained from ANSI, 11 West 42nd St., New York NY 10036; tel: 212/302-1286; fax: 212/398-0023, or ISO.

13.2 AATCC Method 66 interlaboratory test results using the original crease recovery angle devices showed significant differences in *between-laboratory* precision, but good *within-laboratory* precision. The method,

Table I—Precision Factors (95%)

	Option 1		Option 2	
	Warp	Filling	Warp	Filling
Avg of Error Variance	6.08	6.27	17.85	4.80
Standard Deviation	2.47	2.50	4.22	2.19
Critical Differences @ 3/Det/Avg	5.6	5.7	9.6	5.0
Critical Differences @ 6 Det/Avg	3.2	3.2	5.4	2.8

however, cannot be recommended for acceptance testing.

13.3 Most specimens will have a straight, free hanging leg. When the free hanging specimen leg is not straight, alignment problems may cause angle reading difficulty. If a specimen's free leg twists, align the center of the bottom edge of the specimen with the vertical guide line on the tester. If a specimen curls, align the section of the free hanging leg closest to the crease angle with the vertical guide line on the tester.

13.4 Available from Advanced Testing Instruments Corp., 316D Business Pkwy, Greer SC 29651-7119; tel: 864/989-0566; fax: 864/989-0567; e-mail: aticorporation@cs.com. The James H. Heal instrument is called a Crease Recovery Angle Tester but is referred to in TM 66 as the Wrinkle Recovery Tester.

13.5 The instrument manufacturer supplies the apparatus with weights and specimens templates for ISO 2313. Available from ANSI, 11 West 42nd St., New York NY 10036; tel: 212/302-1286; fax: 212/398-0023.

13.6 Practical Procedure for Option 2 Multiple Specimen Testing. This procedure

requires six testers, six weights, 12 plastic presses, 18 specimen holders and one timer. The test run consists of running six specimens concurrently on cycles staggered at 7 min intervals.

13.6.1 After six specimens have been mounted in the press-holder combinations, the first cycle is started by placing weights on all six presses within 5 s. The weights are removed 5 min later in the same order, so that the folding time is the same for all specimens. The specimens are then placed in the clips on recorders as rapidly as possible. The specimens are to be adjusted and read in the same order so that the recovery time will be 5 min for each specimen. One minute after starting to remove the weights and inserting holders into recorders, place weights on the next set of holder press combinations. Start timing with the weight load application. This procedure requires a continuously running clock or timer.

13.6.1.1 Differential times among specimens occur between the folding and the recovery period when specimens are in the plastic presses without load. The differential was found not to have appreciable effect

on test results, in that, the specimens held in holders without load are not free to recover.

13.6.2 Each set of six specimens follows the preceding one by 7 min, the creasing period being started (load application) at 0, 7, 14, etc. min. Continuous operation by this technique will yield 51 readings per h.

13.7 In the spring of 1988, 11 laboratories agreed to participate in an interlaboratory trial to determine the reproducibility of this method. Data was received from nine of the laboratories located in Belgium, South Africa, Sweden, the United Kingdom and five laboratories in the United States.

The *within-laboratory* variability demonstrated in this study is negligible and, while there is more variability between laboratories, that variability is within statistical control. From the data presented, it can be concluded that this test method does provide a test procedure which will allow laboratories to compare the wrinkle behavior of fabrics in a reproducible manner.

The full study containing all raw data is available from the secretariat of ISO/TC 38/SC2 (ANSI) upon request.

Water Repellency: Tumble Jar Dynamic Absorption Test

Developed in 1952 by AATCC Committee RA63; revised 1961, 1997, 2000; reaffirmed 1964, 1967, 1972, 1975, 1978, 1983, 1988, 1989; editorially revised 1985, 1986; editorially revised and reaffirmed 1994, 2005.

1. Purpose and Scope

1.1 This test method is applicable to any textile fabric, which may or may not have been given a water-resistant or water-repellent finish. It measures the resistance of fabrics to wetting by water. It is particularly suitable for measuring the water-repellent efficacy of finishes applied to fabrics, because it subjects the treated fabrics to dynamic conditions similar to those often encountered during actual use. It is not intended for use in predicting the probable rain penetration resistance of fabrics, since it measures absorption of water into, but not through, the fabric.

1.2 The results obtained with this test method depend primarily on the resistance to wetting or water repellency of the fibers and yarns in the fabric, and not upon the construction of the fabric.

2. Principle

2.1 Prewighed specimens are tumbled in water for a fixed period of time and are reweighed after the excess water has been removed from them. The percentage increase in mass is taken as a measure of the absorption or resistance to internal wetting.

3. Terminology

3.1 **absorbency**, n.—the propensity of a material to take in and retain a liquid, usually water, in the pores and interstices of the material.

3.2 **water repellency**, n.—*in textiles*, the characteristic of a fiber, yarn or fabric to resist wetting.

4. Safety Precautions

NOTE: These safety precautions are for information purposes only. The precautions are ancillary to the testing procedures and are not intended to be all inclusive. It is the user's responsibility to use safe and proper techniques in handling materials in this test method. Manufacturers MUST be consulted for specific details such as material safety data sheets and other manufacturer's recommendations. All OSHA standards and rules

must also be consulted and followed.

4.1 Good laboratory practices should be followed. Wear safety glasses in all laboratory areas.

4.2 Observe wringer safety especially at nip points. Normal safeguards should not be removed. A foot-operated kickoff is recommended.

4.3 The manufacturer's safety recommendations should be followed when operating laboratory testing equipment.

5. Apparatus and Materials

5.1 Dynamic Absorption Tester (see Fig. 1 and 11.1).

5.2 Wringer (motor-driven) (see 11.2).

5.3 Laboratory balance, accurate to 0.1 g.

5.4 White AATCC Textile Blotting Paper, 25 × 25 cm (see 11.3).

5.5 Water, distilled.

5.6 Plastic container, or gallon "zipper" type plastic bag.

6. Test Specimens

6.1 The fabric samples and the blotting paper should be conditioned at $65 \pm 2\%$ RH and $21 \pm 1^\circ\text{C}$ ($70 \pm 2^\circ\text{F}$) for a minimum of 4 h before testing.

6.2 Test two specimens from each sample. Each specimen consists of five 20 × 20 cm pieces cut on a 0.79 rad (45°) bias. Remove loose corner yarns and spread a drop of liquid latex or rubber cement on yarns at the corner to prevent raveling. Mark a corner of each piece of specimen for identification as a part of the specimen set.



Fig. 1—Dynamic absorption tester.

7. Procedure

7.1 Rinse the tumble jar of the Dynamic Absorption Tester thoroughly to free it from all extraneous matter, particularly soaps, detergents and wetting agents.

7.2 Roll together the five pieces of each specimen (constituting a specimen set) and weigh to the nearest 0.1 g.

7.3 Pour 2 L of distilled water at $27 \pm 1^\circ\text{C}$ ($80 \pm 2^\circ\text{F}$) in the tumble jar of the Dynamic Absorption Tester. Put both specimen sets into the jar (see 11.4) and rotate for 20 min.

7.4 Remove a piece of one specimen immediately passing it through the wringer at a rate of 2.5 cm/s with the edge of the piece parallel to the rolls and then sandwich the specimen between two pieces of unused blotter paper and pass it through the wringer again. Leave the piece sandwiched in the wet blotters. Repeat this process for the remaining four pieces of the same specimen set. Then remove the blotters and roll the five pieces together, put them in a tared plastic container or gallon-sized zippered plastic bag, close the container and weigh the wet specimen set to the nearest 0.1 g. The mass of the wet specimen should not be more than twice its dry mass.

7.5 Repeat 7.4 for the second specimen.

8. Calculations

8.1 Calculate the water absorbed for each specimen to the nearest 0.1% using the following equation:

$$WA = (W - C)/C \times 100$$

where:

WA = water absorbed, %

W = wet specimen weight, g

C = conditioned specimen weight, g

8.2 Calculate the dynamic absorption of the fabric sample by averaging together the water absorbed by each of the two specimens.

9. Report

9.1 Report the average of the two specimens as the percent of water absorbed by the fabric.

9.2 Report the test method number.

10. Precision and Bias

10.1 *Precision*. In 1998, a limited intralaboratory study was completed. All samples were tested by the same operator.

10.1.2 Four sets of fabrics were analyzed. There was no statistical difference found between the sets of data, thus precision parameters were calculated on the pooled data.

10.1.3 Users of the method are advised of the limited nature of this study and advised to apply these findings with due caution.

10.1.4 Analysis of the combined data yielded a repeatability standard deviation of 1.8, and components of variance and critical differences as displayed in Table I. Differences between two averages of (*N*) determinations, for the appropriate precision parameter, should reach or exceed the table value to be statistically significant at the 95% confidence level.

Table I—Components of Variance and Critical Differences

Det in Avg (<i>N</i>)	95% Confidence Interval	Critical Differences
2	+ 16.2	32.4
3	+ 4.5	9.0
4	+ 2.9	5.8
5	+ 2.2	4.4

10.2 *Bias*. Dynamic absorption of fabrics can only be defined in terms of a test method. There is no independent, referee method for determining the true value. This test method has no known bias.

11. Notes

11.1 The Dynamic Absorption Tester (see Fig. 1) should consist of a motor driven, 6 L cylindrical or hexagonal-shaped jar approximately 15 cm in diameter and 30 cm in length, mounted to rotate end over end at 55 ± 2 rpm

with a constant tangential velocity. The jar may be of glass, corrosion-resistant metal, or chemical stoneware.

11.1.1 The apparatus is available from SDL Atlas L.L.C., 1813A Associate Lane, Charlotte NC 28217; tel: 704/329-0911; fax: 704/329-0914; e-mail: info@sdlatlas.com.

11.1.2 The revolutions per min of the tumble jar should be determined by counting the number of revolutions in 1 min using a stopwatch calibrated in intervals of not more than 1 s.

11.2 The wringer, household laundry type, should be equipped with soft rubber squeeze rolls 5.1-6.4 cm in diameter and 28.0-30.5 cm in length, with a hardness of 70-80 when measured using the A Scale of a Shore Durometer. The wringer should be so constructed that the pressure on the top of the piece of fabric is maintained by a dead weight or lever system such that the total pressure (resulting from the total of the dead weight or lever system and the weight of the roller) is 27.2 ± 0.5 kg. It should be power-driven at a constant rate so that the piece of fabric passes through the rolls at a rate of 2.5 cm/s. Also suitable is the Atlas Motorized Laboratory Wringer available from SDL Atlas L.L.C., 1813A Associate Lane, Charlotte NC 28217; tel: 704/329-0911; fax: 704/329-0914; e-mail: info@sdlatlas.com.

The diameters of the squeeze rolls should be determined with a pair of calipers or directly with a suitable micrometer. Measurements should be made at five different places along the length of each roll, and the average of these measurements taken as the diameter of the roll.

The load applied by the dead weight or lever system should be measured using a spring scale or balance, and suspending the top roll of the wringer from the scale by means of two tapes of equal length. The tapes should be placed between the rolls near their ends and should be provided with a means of holding them sufficiently far apart so that there is no contact between the tapes and the top structural member of the wringer and loading sys-

tem. The spring scale or balance should be suspended from a suitable rigid support and provided with a turnbuckle or other device for adjusting the height of the scale. The usual precautions concerning the zero correction of spring scales should be observed. The turnbuckle or other device should then be adjusted to place the weight of the top roll and its weighing system on the spring scale or balance, and the system should be considered to be in equilibrium when the top roll of the wringer has been lifted just sufficiently from the bottom roll to permit vision between the bottoms of the tapes and the top of the bottom roll. At this point, the dead weight on the loading system should be adjusted until the spring scale or balance indicates a load of 27.2 ± 0.5 kg. The calibration of the spring scale or balance should be verified by the use of known certified dead weights of 24.95, 27.22 and 29.48 kg ± 0.23 kg total weight. The spring scale should be accurate to within ± 0.2268 kg at each of the three verification loads.

The linear speed of the rolls should be measured by feeding a thin steel tape through the rolls. The steel tape should be at least 150 cm long and should be accurate to within 3 mm per 150 cm. The time required for exactly 150 cm of this tape to pass through the nip of the rolls should be measured in s to the nearest s with a stopwatch calibrated in intervals of not more than 0.5 s. The speed of the rolls should be adjusted until the time required for 150 cm of tape to pass through the nip of the roll is 60 ± 2 s.

11.3 Blotters suitable for this test can be obtained from AATCC, P.O. Box 12215, Research Triangle Park NC 27709; tel: 919/549-8141; fax: 919/549-8933; e-mail: orders@aatcc.org.

11.4 Should it be necessary to run only one specimen, a specimen of similar material with respect to weight should be run as ballast with the specimen undergoing test. The cloth in the jar during any run should be the equivalent of two specimens (10 pieces).

Electrical Surface Resistivity of Fabrics

Developed in 1954 by AATCC Committee RA32; revised 1963, 1968, 1970, 1972, 1973, 1982, 1995, 2000 (with title change); reaffirmed 1969, 1975, 1978, 1989; editorially revised 1974, 1984, 1985, 1997, 2004; editorially revised and reaffirmed 1987, 2005.

1. Purpose and Scope

1.1 The purpose of this test method is to determine the electrical surface resistivity of fabrics. The surface electrical resistivity may influence the accumulation of electrostatic charge of a fabric (refer to AATCC Method 84 for determination of electrical resistance for yarns).

2. Principle

2.1 Specimens at equilibrium with specified atmospheric conditions of relative humidity and temperature are measured for electrical resistance between parallel electrodes by means of an electrical resistance meter.

3. Terminology

3.1 **electrical resistivity, n.**—material property of a substance whose numerical value is equal to the ratio of the voltage gradient to the current density.

NOTE: For the purposes of this method, surface resistivity is calculated by using the measured electrical resistance between superficially positioned parallel plates or concentric rings and their spacing and is reported as ohms per square. This test method in effect measures the resistance of a material to the flow of current between two electrodes.

4. Safety Precautions

NOTE: These safety precautions are for information purposes only. The precautions are ancillary to the testing procedures and are not intended to be all inclusive. It is the user's responsibility to use safe and proper techniques in handling materials in this test method. Manufacturers MUST be consulted for specific details such as material safety data sheets and other manufacturer's recommendations. All OSHA standards and rules must also be consulted and followed.

4.1 Good laboratory practices should be followed. Wear safety glasses in all laboratory areas.

4.2 The safety recommendations provided by the manufacturer of the radioactive bar should be followed.

4.3 The radioactive bar emits alpha radiation which is externally harmless to the human body. The radioactive isotope polonium 210 is toxic and precaution should be exercised to prevent ingestion or inhalation of the solid material. Do not take the radioactive bar apart or touch the radioactive strip under the grid. If the strip is touched or handled, wash hands thoroughly at once. Return the device to the manufacturer when it loses its effectiveness as a static eliminator or for disposal if use is to be discontinued. **Do not discard as scrap.**

5. Apparatus and Materials

5.1 Electrical resistance meter (see 11.1).

5.2 Conditioning and test chamber (see 11.2).

5.3 Standard resistors (see 11.3).

5.4 Radioactive bar (see 11.4).

5.5 Two rectangular flat metal surfaces of suitable size to serve as electrodes.

5.5.1 As an alternative, two concentric ring electrodes of spacing suitable to the material being measured and the purpose of the results (see 11.1.1).

6. Test Specimens

6.1 Adjust the size of fabric test specimens to suit the electrodes of the particular equipment being used. When using parallel plate electrodes, the width of the specimen must not exceed the width of the electrodes. When using the concentric rings, any size specimen at least as large as the outer ring may be used. Avoid contaminating the area on which the measurement is to be made.

6.2 *Specimens for use with instruments providing parallel plate electrodes.* Prepare 2 sets of 3 test specimens each, 1 set each so that the direction of testing is parallel to the yarns in the length direction of the fabric and 1 set with the direction of testing parallel to the width direction of the fabric.

6.2.1 *Test specimens for use with instruments providing concentric ring electrodes.* Prepare 1 set (3 test specimens) since, with this type instrument, the resistance is measured in both fabric length and fabric width directions simultaneously.

6.2.2 Depending on the fabric construction or end-use, it may be advisable to differentiate between face and back measurements. Each test specimen should be taken from a different part of

the fabric.

7. Procedure

7.1 Calibrate the electrical resistance meter according to the manufacturer's recommendations. This calibration should be repeated periodically (see 10.3).

7.2 Condition the test specimens in a suitable testing chamber or conditioning room at a predetermined relative humidity that will reflect the conditions at which information on the electrical resistivity of the fabric is needed.

7.2.1 For most fabrics which require antistatic treatments or whose static propensity is critical, measurements at 20% relative humidity will be most meaningful.

7.2.2 In less critical situations 40% relative humidity may be employed.

7.2.3 For special requirements other relative humidities may be used. For example, preconditioning at $50\% \pm 2\%$ RH at $21 \pm 2^\circ\text{C}$ is required for antistatic sheeting, film and textiles for use in hospital operating rooms (see 11.2.1). Measurements may be made under other conditions or ranges of conditions that are applicable to the end use (such as 65% RH and 24°C). It is preferable to keep the temperature or humidity consistent for all measurements.

7.2.4 If it is necessary to measure electrical resistivity under a broad range of conditions, additional tests may be run at 65% RH and at 24°C or other settings applicable to the end use. It is preferable to keep the temperature or humidity consistent for all measurements.

7.3 Optionally remove static charges on the surface of the fabric by passing a radioactive bar over both sides of the fabric (see 11.4).

7.4 Place a test specimen in firm contact with the electrodes. The contact with the electrodes should be such that, when additional pressure is applied between the fabric and the electrodes, the test results are not affected.

7.4.1 In the case of equipment using parallel plate electrodes, place the test specimen in contact with the electrodes with the direction of the test perpendicular to the adjacent edges of the electrode. Measure the electrical resistance of the fabric in both the length and width directions. Since the charge will follow the path of least resistance, record only the lower reading by direction.

7.4.2 For concentric ring electrodes, the charge follows the path of least resistance automatically.

7.5 Measure the electrical resistance of the test specimen according to the operating instruction and procedures for the particular resistance meter being used. Allow the current to pass through the test specimen for 1 min or until a constant reading is obtained. The criterion for constant electrical resistivity is a change in the value of Log R of less than 0.1 units per minute. The time to reach a constant reading may vary with the applied voltage and with the resistance of the test sample. High voltages for prolonged periods of time may damage the fabric.

7.6 For referee purposes, 80-100 volts at 25 mm electrode separation for 1 min should be used for the parallel plate configuration, and a similar voltage gradient for the concentric ring case (see 11.6).

7.7 Avoid the use of any electrically conductive liquids on either the fabric test specimens or the apparatus.

8. Evaluation

8.1 Compute the resistivity to the nearest ohms per square as follows:

8.1.1 For the parallel electrode case:

$$R = O \times W/D$$

where:

R = resistivity in ohms per square
 O = measured resistance in ohms
 W = width of specimen
 D = distance between electrodes

8.1.2 For the concentric ring case:

$$R = 2.73(O)/\log r_o/r_i$$

where:

R = resistivity in ohms per square
 O = measured resistance in ohms
 r_o = outer electrodes radius
 r_i = inner electrodes radius

8.2 Calculate the average resistivity for each sample and for the lot.

8.3 Determine the logarithm (base 10) of the resistivity (Log R) for each sample and for the lot.

9. Report

9.1 Report the following information:

9.1.1 The Log R for each sample and for the lot.

9.1.2 the number of specimens tested.

9.1.3 The relative humidity and temperature used.

9.1.4 The direction of testing if parallel plate electrodes were used.

10. Precision and Bias

10.1 *Precision*. Precision for this test method has not been established. Until a precision statement is generated for this test method, use standard statistical techniques in making any comparisons of test results for either *within-laboratory* or *between-laboratory* averages. Experience has shown that, with care, reproducibility should be $\pm \leq 2\%$ average Log R .

10.2 *Bias*. Electrical resistivity can be defined only in terms of a test method. There is no independent method for determining the true value. As a means of estimating this property, the method has no known bias.

11. Notes

11.1 The resistance meter in conjunction with the electrode system should be capable of measuring values in the range of 10^8 - 10^{15} for any critical uses. Equipment that is capable of measuring values in the range of 10^8 - 10^{13} ohms is suitable for work where the product performance is known to be acceptable if resistance is $< 10^{13}$ ohms.

11.1.1 A concentric ring instrument complete with adequate shielding, capable of measuring values in the range of 10^8 - 10^{15} ohms, is available from Keithley Instruments Inc., 28775 Aurora Rd., Cleveland OH 44139; tel: 440/248-0400.

11.1.2 Instruments capable of measuring values in the range of 10^8 - 10^{13} ohms are available from Teradyne Inc., 600 River Park Dr., North Reading MA 61864; tel: 978/370-2700.

11.1.3 A description of an instrument that will not allow measurements $> 10^{13}$ ohms is described by Hayek & Chromey in *American*

Dyestuff Reporter, Vol. 40, 1951, pp 164-8.

11.1.4 Other resistance testers also may be satisfactory for this test.

11.2 A conditioning and testing chamber is required capable of providing relative humidity control of $\pm 2\%$ (preferably effective over a range of 20-65% RH) and temperature control of $\pm 1^\circ\text{C}$ ($\pm 2^\circ\text{F}$) with circulating air. Since equilibration of a test specimen from the dry versus the wet condition relative to the humidity of the test chamber may show hysteresis, it is recommended that specimens approach equilibrium from the dry side relative to the humidity in the test chamber whenever possible.

11.2.1 National Fire Protection Association, Standard NFPA Code #56 A-1973 Section 4663.

11.3 Standard resistors suitable for calibration of the electrical resistance meter are available from Victoreen LLC, 6000 Cochran Rd., Cleveland OH 44139-3395; tel: 440/248-9300; fax: 440/248-9301.

11.4 The following radioactive bar, Static-master Ionizing Unit, Model 2 U 500, has been found to be suitable for the removal of electrostatic charges from fabrics and is available from NRD Inc., 2937 Alt. Blvd. North, Grand Island NY 14072; tel: 716/773-7634.

11.5 Accumulation of static electricity generally is greater the lower the relative humidity (and vice versa). Fabrics which show a low degree of static accumulation of 40% RH may exhibit severe static accumulation of 20-25% RH, while fabrics which exhibit static problems at 40% RH may exhibit a low degree of static accumulation of 65% RH. The relationship between the tendency for static accumulation and relative humidity varies with the specific antistatic agent, fiber, fabric construction, surface character, etc. Therefore, 40% RH may not provide significant information as to the probable antistatic performance properties of a fabric unless the tests are also run at 20-25% RH, an atmospheric condition not unusual in modern heated and air-conditioned buildings. Complete information may also require information of resistivity at the upper level of 65% RH.

11.6 For more detailed information regarding the measurement of resistances, see ASTM Test D 257, Tests for D-C Resistance or Conductance of Insulating Materials (ASTM Committee D-20).

Absorbency of Bleached Textiles

Developed in 1954 by AATCC Committee RA34; jurisdiction transferred in 2003 to AATCC Committee RA63; reaffirmed 1968, 1972, 1975, 1979, 1992, 2000; editorially revised and reaffirmed (with title change) 1986; revised 1995.

1. Purpose and Scope

1.1 Absorbency is one of several factors that determines the suitability of a fabric for a particular use, as in the case of gauze or toweling. It is important in fabrics that are to be dyed, since the completeness and uniformity of the dyeing are dependent upon the absorbency. Where fabrics are to be given resin or other specialized finishes, absorbency is a factor to be considered. Wettability or absorbency of textile fabrics or yarns can be determined by this test method.

2. Principle

2.1 A drop of water is allowed to fall from a fixed height onto the taut surface of a test specimen. The time required for the specular reflection of the water drop to disappear is measured and recorded as wetting time.

3. Terminology

3.1 **absorbency**, *n.*—the propensity of a material to take in and retain a liquid, usually water, in the pores and interstices of the material.

4. Safety Precautions

NOTE: These safety precautions are for information purposes only. The precautions are ancillary to the testing procedures and are not intended to be all inclusive. It is the user's responsibility to use safe and proper techniques in handling materials in this test method. Manufacturers MUST be consulted for specific details such as material safety data sheets and other manufacturer's recommendations. All OSHA standards and rules must also be consulted and followed.

4.1 Good laboratory practices should be followed. Wear safety glasses in all laboratory areas.

5. Apparatus

5.1 Embroidery hoop with a 150 mm

(6 in.) or more diameter.

5.2 Burette, delivering 15-25 drops of water per milliliter.

5.3 Stopwatch.

5.4 Burette stand.

6. Test Specimen

6.1 A swatch or skein of bleached material can be used for this test, as long as the specimen can be spread tightly over an embroidery hoop.

6.2 Specimens sampled prior to drying should first be air dried. All specimens should be brought to moisture equilibrium in a standard atmosphere having a relative humidity of $65 \pm 2\%$ at $21 \pm 1^\circ\text{C}$ ($70 \pm 2^\circ\text{F}$) (see 10.1).

7. Procedure

7.1 Conduct the test in a standard atmosphere as defined above.

7.2 Mount the cloth (or smoothed-out, thick portion of yarn) in the embroidery hoop so that the surface is free of wrinkles, but without distorting the structure of the material.

7.3 Place the hoop about 10 ± 1 mm (0.375 in.) below the tip of the burette, and allow one drop of distilled or deionized water at $21 \pm 3^\circ\text{C}$ ($70 \pm 5^\circ\text{F}$) to fall on the cloth.

7.4 Using a stopwatch, measure the time required, up to 60 s maximum, for the surface of the liquid to lose its specular reflectance. This point is determined by having the hoop between the observer and a source of light—such as a window or laboratory spotlight—at such an angle that the specular reflectance of light from the surface of the flattened drop can be plainly seen. As the drop is gradually absorbed, the area of this tiny mirror diminishes and finally vanishes entirely, leaving only a dull wet spot. At this instant the watch is stopped and the elapsed time is recorded. When the wetting time exceeds 60 s, 60+ s should be recorded.

7.5 Take 5 readings.

8. Calculation and Evaluation

8.1 Average the 5 time readings. The shorter the average time, the more absorbent is the textile. Five seconds or less is generally considered to represent adequate absorbency.

9. Precision and Bias

9.1 *Interlaboratory Study.* Tests for absorbency of bleached textiles were conducted in 1992, with 5 laboratories evaluating 7 fabrics. Participating laboratories were presumed to be performing the test method under statistical control, without verification.

9.1.1 The analysis of variance technique was applied to the data set. The analysis is being retained for reference in RA34 committee files.

9.2 Precision.

9.2.1 When two or more laboratories wish to compare test results, it is recommended that laboratory level be established between them prior to beginning test comparisons.

9.2.2 Critical differences for single fabric comparisons and for multiple fabric comparisons are given in Tables I and II, respectively.

Table I—Critical Difference for Single Fabric Comparisons (seconds) (95% probability)

Det/Avg	Single Operator	Within Laboratory	Between Laboratory
2	2.5	2.5	4.1
4	1.8	1.8	3.7
5	1.6	1.6	3.6
10	1.1	1.1	3.5

Table II—Critical Difference for Multiple Fabric Comparisons (seconds) (95% probability)

Det/Avg	Single Operator	Within Laboratory	Between Laboratory
2	4.0	4.0	7.1
4	3.6	3.6	6.8
5	3.5	3.5	6.8
10	3.3	3.3	6.7

9.2.3 If difference comparisons are made on a single fabric, critical differences in Table I are used, with units of seconds.

9.2.4 If difference comparisons are made on multiple fabrics, critical differences in Table II are used, with units in seconds.

9.2.5 The number of determinations in an average (Det/Avg) is a factor in determining the magnitude of critical differences.

9.2.6 If two laboratories are shown to be in statistical control and operating at comparable levels, the magnitude of applicable critical differences may be less

than those given in these tables, and may be determined by data from comparison trials between them.

9.3 *Bias*. The true value of absorbency of bleached fabrics can be defined only in terms of a test method. There is no independent method for determining the true value. In estimating this property, the test

method has no known bias.

10. Note

10.1 It has been observed that if specimens collected at drying cans are not brought to moisture equilibrium, the wetting times could falsely indicate poor absorbency for that material.

pH of the Water-Extract from Wet Processed Textiles

Developed in 1954 by AATCC Committee RA34; revised 1963, 1996 (with title change); reaffirmed 1968, 1969, 1974, 1977, 1980, 1983, 1988, 1989, 2001; editorially revised 1990. Related to ISO 3071.

1. Purpose and Scope

1.1 This test method determines the pH of wet processed textiles either scoured or bleached.

1.2 To make a quantitative determination, the chemicals which influence pH must be removed from the textile specimen, collected as a water extract and then accurately measured by a pH meter.

2. Principle

2.1 The specimen is boiled in distilled or deionized water. The water-extract is cooled to room temperature and the pH is determined.

3. Terminology

3.1 **bleaching**, n.—elimination of unwanted coloring matter from a textile substrate by oxidative or reductive chemical treatment.

3.2 **pH**, n.—the negative logarithm of the effective hydrogen ion concentration or hydrogen ion activity in gram equivalents per liter used in expressing both acidity and alkalinity on a scale whose values run from 0-14 with 7 representing neutrality, numbers less than 7 increasing acidity and numbers greater than 7 increasing alkalinity.

3.3 **wet processing**, n.—in textile manufacturing, a collective term for processes included in preparation, dyeing, printing and finishing in which the textile material is treated with a liquid, normally water, or with chemicals in solution or dispersion in a liquid.

4. Safety Precautions

NOTE: These safety precautions are for information purposes only. The precautions are ancillary to the testing procedures and are not intended to be all inclusive. It is the user's responsibility to use safe and proper techniques in handling materials in this test method. Manufacturers MUST be consulted for specific details such as material safety data sheets and other manufacturer's recommendations. All OSHA standards and rules must also be consulted and followed.

4.1 Good laboratory practices should be followed. Wear safety glasses in all

laboratory areas.

4.2 All chemicals should be handled with care.

5. Uses and Limitations

5.1 pH can be used to determine the suitability of wet processed textiles for subsequent dyeing and/or finishing operations or to evaluate the washing and/or neutralizing efficiency following any wet processing operation.

5.2 This method should be used in conjunction with AATCC Test Method 144, Alkali in Wet Processed Textiles: Total, in order to quantitatively determine the amount of an alkali present. While pH gives an indication of relative alkali or acid content, the exact amount can be masked by the presence of strong buffering agents.

6. Apparatus and Materials

6.1 pH meter with 0.1 unit graduations.

6.2 Beakers, glass, 400 mL.

6.3 Buffer solutions, pH 4.0, 7.0, 10.0 or others as needed.

7. Calibration

7.1 Calibrate the pH meter in accordance with the manufacturer's instructions. Select buffer solutions for calibration which are in the estimated range of the specimens' pHs.

8. Specimens

8.1 Use a 10 ± 0.1 g specimen of the material to be tested. If the weight per square yard of the fabric is excessively low, cut the sample into small pieces.

9. Procedure

9.1 Boil 250 mL of distilled water at a moderate rate for 10 min. Immerse the specimen, cover the beaker with a watch glass and boil for an additional 10 min.

9.2 Allow the covered beaker and contents to cool to room temperature. Remove the specimen with tweezers, allowing the excess liquid to drip back into the extract.

9.3 Determine the pH of the extract using a pH meter operated according to manufacturer's instructions.

10. Evaluation

10.1 The pH of the water-extract depends on the chemical treatment previously given the textile, the pH of the wash water, and the efficiency of the washing operation.

10.2 Normally, the pH of the water-extract will be higher after caustic boiling than after bleaching. If the textile is scoured after bleaching, the pH may be lower.

10.3 Textiles with high pH values may exhibit yellowing tendencies, create shade changes, alter the exhaustion and fixation of dyes, and produce a decrease in the cure of resin finishes or exhaustion of softeners.

11. Precision and Bias

11.1 Precision.

11.1.1 In late 1993, an interlaboratory study was completed, which included five laboratories, two operators in each, running three determinations per fabric, on four fabrics. No prior assessment was made of the relative level of performance of the participating laboratories.

11.1.2 Analysis of the data set ($5 \times 2 \times 3 \times 4 = 120$ values) yielded components of variance as follows:

Laboratories	0.1203
Operators within laboratories	0.0150
Specimens within materials, laboratories, and operators	0.0188

11.1.3 Table I indicates the critical differences calculated using the values in 11.1.2.

Table I—Critical Differences for Two Averages—95% Probability Level

pH of Water-Extract from Bleached Textiles

N	Single Operator	Within Laboratory	Between Laboratory
1	0.38	0.51	1.09
2	0.27	0.43	1.05
4	0.19	0.39	1.04
8	0.13	0.37	1.03

11.1.4 Differences between two averages of N determinations, for the appropriate precision parameter, should reach or exceed the table value to be statistically significant at the 95% probability level.

11.2 Bias.

11.2.1 To the extent the pH meter used in this test method is capable of measuring values of pH that are consistent with true values of pH, the determination of the pH of the water-extract from a bleached textile, using this test method, has no known bias. During this study, no determination was made of the true value of this property by an independent, referee analytical method for the purpose of establishing presence or absence of bias.

Fluidity of Dispersions of Cellulose from Bleached Cotton Cloth

Developed in 1954 by AATCC Committee RA34; reaffirmed 1961, 1968, 1972, 1975, 1979, 1984; editorially revised 1974, 1975, 1983, 1985, 1988, 1990, 2004; editorially revised and reaffirmed 1989, 2001; revised 1996.

1. Purpose and Scope

1.1 The test procedures in this test method are applicable to bleached, unfinished cotton cloth. The fluidity of a dispersion of bleached cellulose fibers in cupriethylene diamine or cuprammonium hydroxide solvent is a sensitive measure of the degradation of the cellulose resulting from the action of acids, alkalis, oxidizing or reducing agents. It is therefore useful in determining the completeness of the bleaching treatment to which the cloth has been subjected, as well as the effect of chemical treatments on the tensile strength of the cloth.

2. Principle

2.1 The length of chain of cellulose molecules is decreased when treated with acid, alkali, oxidizing or reducing agents, etc. The severity of the treatment determines the extent of the shortening of the cellulose chain and the fluidity, or ease of flow, of a dispersion of the cellulose in the solvents.

3. Terminology

3.1 **fluidity**, *n.*—of a cellulose solution, a measure of the ease of flow or motion of a solution, and therefore an indicator of the molecular weight of the cellulose.

3.2 **rhe**, *n.*—the unit of fluidity; the reciprocal of the unit of viscosity (the poise).

4. Safety Precautions

NOTE: These safety precautions are for information purposes only. The precautions are ancillary to the testing procedures and are not intended to be all inclusive. It is the user's responsibility to use safe and proper techniques in handling materials in this test method. Manufacturers MUST be consulted for specific details such as material safety data sheets and other manufacturer's recommendations. All OSHA standards and rules must also be consulted and followed.

4.1 Good laboratory practices should be followed. Wear safety glasses in all laboratory areas.

4.2 All chemicals should be handled with care. Use chemical goggles or face shield, impervious gloves and an impervious apron during dispensing and mixing. CAUTION: Always add acid to water.

4.3 An eyewash/safety shower should be located nearby and a self-contained breathing apparatus should be readily available for emergency use.

4.4 Exposure to chemicals used in this procedure must be controlled at or below levels set by governmental authorities (e.g., Occupational Safety and Health Administration's [OSHA] permissible exposure limits [PEL] as found in 29 CFR 1910.1000 of January 1, 1989). In addition, the American Conference of Governmental Industrial Hygienists (ACGIH) Threshold Limit Values (TLVs) comprised of time weighted averages (TLV-TWA), short term exposure limits (TLV-STEL) and ceiling limits (TLV-C) are recommended as a general guide for air contaminant exposure which should be met (16.1).

5. Materials and Reagents

- 5.1 Ammonium hydroxide (NH₄OH)
- 5.2 Cupriethylene diamine
- 5.3 Cuprammonium hydroxide
- 5.4 Nitric acid (HNO₃)
- 5.5 Glacial acetic acid (CH₃COOH)
- 5.6 Sodium hydroxide (NaOH)
- 5.7 Cupric hydroxide (Cu(OH)₂)
- 5.8 Ethylene diamine (H₂NCH₂CH₂NH₂)
- 5.9 Sulfuric acid (H₂SO₄)
- 5.10 Nitrogen (N₂)
- 5.11 Bromine (Br₂)
- 5.12 Potassium iodide (KI)
- 5.13 Sodium thiosulfate (Na₂S₂O₃)
- 5.14 Methyl Red indicator
- 5.15 Ostwald Cannon-Fiske viscometers (see 16.3)
- 5.16 Cuprammonium dissolving tubes (see 11.2)
- 5.17 Capillary viscometers (see 11.3)

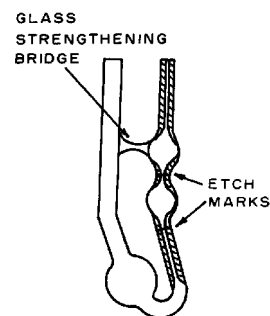

Fig. 1—Ostwald Cannon-Fenske cuen viscosimeter.

6. Preparation of Sample

6.1 Use a representative sample of bleached and unfinished cloth weighing not less than 5 g.

6.2 Cut the sample by hand, with electric scissors, or by use of a Wiley cutting mill with a 20-mesh sieve and top delivery tube, so that short individual fibers about 1.5 mm (0.06 in.) long are obtained.

6.3 Run duplicate tests, using fibers from the one sample. Divide the cut sample into two portions of approximately equal weight and store in separate containers overnight in a desiccator containing conc. sulfuric acid. Samples conditioned in this manner will have a moisture content of 2%.

6.4 The purpose of dividing the sample into two portions is to reduce the time of exposure to the atmosphere during weighing. The weight of the specimen for the fluidity determination should be sufficient to give a 0.5% solution of the cotton.

7. Method No. 1—Dispersion in Cupriethylene Diamine Hydroxide (Cuen)

7.1 Ostwald Cannon-Fenske-type viscosimeters (Fig. 1) having the characteristics shown in Table I are suitable for determining fluidities in the range normally found for bleached cotton.

Table I—Viscosimeter Characteristics

Size No.	Approx. Range of Efflux Time, s	Capillary Diameter, cm	Fluidity Range Rhes
200	100 to 700	0.097 to 0.103	1.43 to 10.0
300	100 to 700	0.120 to 0.130	0.80 to 4.0
400	100 to 700	0.180 to 0.190	0.1175 to 0.83

8. Preparation of Solutions

8.1 Prepare 0.167M cupriethylene diamine solution by diluting 167 mL of the 1.0M solution with freshly boiled and cooled water to 1 L in a volumetric flask, observing all precautions to exclude air.

8.2 Store the reagents at all times under oxygen-free nitrogen to minimize decomposition.

8.3 Measure the 1.0M and 0.167M solutions from burettes of known accuracy. The burettes may be attached to the reagent storage bottles by means of a side arm sealed into the lower part of the burette and filled by application of nitrogen pressure on the storage bottle.

9. Procedure

9.1 Weigh 0.4-0.45 g of the sample, prepared as previously described to the nearest 0.1 mg. Remove the samples from the desiccator one at a time, and make the weighings as quickly as possible to prevent additional moisture pickup from the air.

9.2 Transfer the fibers carefully from the weighing dish or watch glass to an approximately 120 mL (4 oz.) wide-mouth amber glass bottle.

9.2.1 To the specimen in the solution bottle, add X mL of 0.167M cupriethylene diamine solution, where X is calculated as follows:

$$X = 120 \times \text{weight of specimen} \times 0.98$$

9.3 Sweep out the air in the bottle above the solution by applying a brisk stream of purified nitrogen over the surface of the solution for 20 s, and quickly screw the cap of the bottle in place.

9.4 Shake the bottle by means of an automatic shaker at intermediate speed for 2 h.

9.5 Remove the bottle from the shaker and add to the solution Y mL of 1.0M cuen, where Y is calculated as follows:

$$Y = 80 \times \text{weight of specimen} \times 0.98$$

9.6 Repeat the nitrogen treatment and bottle-shaking as described, with the exception that the shaking time should be 3 h.

9.7 Permit the bottle to stand for 30 min after removing from the shaker and before loading the viscosimeter. The viscosimeter is loaded by inverting it with the capillary side arm submerged in the cellulose dispersion and applying suction to the other arm of the instrument. Draw the dispersion into both the bulbs on the capillary arm to the etched mark. Rotate the pipette to its normal vertical position, and place the viscosimeter in a constant-temperature water bath at $25 \pm 1^\circ\text{C}$ ($77 \pm 2^\circ\text{F}$). The liquid will drain into the lower reservoir and will reach temperature equilibrium with the bath (ap-

prox. 5 min).

9.8 Determine the efflux time by drawing the liquid above the mark between the two bulbs and measuring the time for the meniscus to pass from the mark between the two bulbs to the mark below the lower bulb. Take the average of two or more observations.

10. Calculations

10.1 The fluidity in rhes, F , is calculated as follows:

$$F = 100/ctd$$

where:

c = instrument constant determined from a liquid of known viscosity.

t = time of discharge of the liquid within the ring interval.

d = density of cuen solution, 1.052.

11. Method No. 2—Dispersion in Cuprammonium Hydroxide (Cuam)

11.1 Use viscosimeters of the glass pipette type with the dimensions shown in Fig. 2.

11.2 Dissolving tube.

11.2.1 The dimensions of the tube used for dissolving cellulose in cuprammonium solution are shown in Fig. 3. It is recommended that the tubes be made of heavy walled tubing to withstand the dropping force of the stainless steel balls. The volume of the tube is approximately 35 mL but this volume should be measured accurately by weighing the empty stoppered tube containing the stainless steel balls and then weighing it again filled with distilled water. Two 0.63 cm (0.25 in.) diameter stainless steel balls are used in each dissolving tube. These tubes can be purchased from the Ace Glass Co., Vineland NJ (Cat. No. B-1980).

CLOTH	FLUIDITY—RHES	
	CUEN	CUAM
GREIGE	0.2 - 0.4	1.0 - 2.0
MILDLY TREATED	0.3 - 0.7	1.5 - 2.5
AVERAGED BLEACHED	0.9 - 3.3	3.0 - 7.0
OVERBLEACHED	5.5 - 15.3	10.0 - 20.0

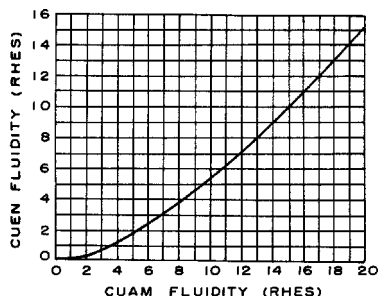

Evaluation—Cuam and cuen fluidities.

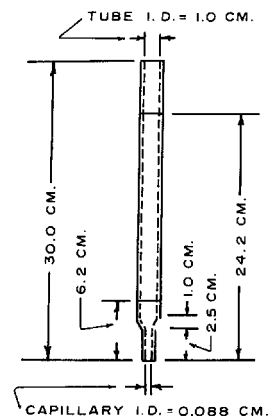

Fig. 2—Cuprammonia viscosimeter tube.

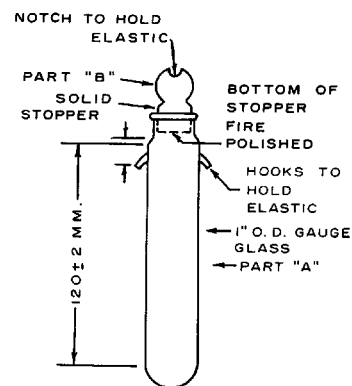

Fig. 3—Dissolving tube for cuam solutions.

12. Preparation of Solution

12.1 The cuprammonium solution should contain per liter 15 ± 0.25 g of copper, 200 ± 10 g of ammonia, and less than 0.5 g of nitrites and nitrates calculated as nitrous acid. Prepare the cuprammonium solution by passing a stream of air through a solution of ammonium hydroxide (sp gr 0.88-0.90) at room temperature, and then bubbling it into approximately 1.5 L of a solution of ammonium hydroxide (sp gr 0.88-0.90) at $0 \pm 1^\circ\text{C}$ ($32 \pm 2^\circ\text{F}$) in which is dissolved 1.5 g of cane sugar, and to which has been added 60 g of powdered copper. Stir the solution constantly and continue the stream of air until the solution contains a little more than 17 g of copper per liter as determined by the following test: Stop the stirring and the flow of air and allow the undissolved copper to settle for a few minutes. Transfer 5 mL of the dispersion by means of a pipette to a Nessler tube and dilute to 50 mL with water. To a second Nessler tube containing 10 mL of ammonium hydroxide (sp gr 0.90), add 5

mL of a copper sulfate solution containing 17 g of copper (67 g $\text{CuSO}_4 \cdot 5\text{H}_2\text{O}$) per liter, and dilute to 50 mL with water. Compare the test solution with the standard for depth of color. Continue the flow of air and stirring until the test solution just shows a noticeably deeper color than that of the standard, then stop the stirring and flow of air, and allow the undissolved copper to settle overnight.

12.2 The nitrites and nitrates are kept within the limits by minimizing the stirring time and keeping the temperature down to 5-10°C (41-50°F). A high enough copper concentration should be obtained with 1.5 h of vigorous stirring. If a stirring time of over 5 h is required to obtain the proper copper concentration, the oxidation of ammonia to nitrous acid may be excessive and the solution will be unsuitable.

12.3 Storage and analysis of solution.

12.3.1 Storage bottle. Use a 2 L bottle for storing a 1.5 L batch of the cuprammonium solution. Fit the bottle with a 2-hole rubber stopper carrying a T-tube of capillary bore and a glass siphon delivery tube, the short leg of which reaches to the bottom of the bottle. A stopcock is part of the vertical arm of the T-tube. Fit the delivery end of the siphon tube with a length of heavy rubber tubing carrying a pinchcock and a glass tip similar to that used on a laboratory wash-bottle. Keep the delivery end of the T-tube closed when not in use. To prevent clogging of the glass tip of the delivery tube with dried solution, cover it with a piece of rubber tubing carrying a pinchcock.

12.3.2 Analysis. Decant the clear cuprammonium solution from the undissolved copper, pour a known volume into the storage bottle and then close the bottle with a solid rubber stopper. Withdraw test samples with a pipette and analyze for copper and ammonia.

12.3.3 Determination of copper. Place a 10 mL sample of the cuprammonium solution in a 250 mL Erlenmeyer flask, together with 25 mL of distilled water, and boil the solution until all the ammonia is expelled. Add 5 mL of dilute nitric acid (1:1) and continue boiling until the red fumes are completely expelled. Then add about 2 mL of bromine to oxidize any remaining nitrous acid, and again boil to expel any excess bromine. Cool the solution, dilute it to 75 mL and add dilute ammonium hydroxide (1:1) until the solution just assumes a dark blue color. Add 5 mL of glacial acetic acid and 10 mL of potassium iodide solution (30%), and titrate the solution with 0.1N sodium thiosulfate, adding starch indicator at the end of the titration. Calculate the copper content of the cuprammonium solution in grams per liter from the following formula:

$$C = V \times N \times 6.357$$

where:

C = copper in grams per liter

V = volume of sodium thiosulfate in milliliters, and

N = normality of the sodium thiosulfate solution.

12.3.4 Determination of ammonia. Pipette a 2 mL sample of the cuprammonium solution into 50 mL of 1N sulfuric acid, keeping the tip of the pipette below the surface of the liquid. Titrate the excess acid with 1N sodium hydroxide, using methyl red. as the indicator. Calculate the ammonia content of the cuprammonium solution in grams per liter from the following formula:

$$A = (50 - V) 8.5 - 0.536 W$$

where:

A = ammonia, grams per liter

V = volume of 1N sodium hydroxide in milliliters, and

W = copper content in grams per liter (see 10.5.3).

12.4 Standardization.

12.4.1 Adjust the cuprammonium solution to the requirements for copper and ammonia content as prescribed. Calculate the amounts of ammonium hydroxide (sp gr 0.90) and water required to give the specified grams per liter of copper and ammonia from the results of the determination in 10.5.3 and 10.5.4 above. Add the calculated amounts and thoroughly shake the contents of the bottle. Check the adjusted cuprammonium solution for copper and ammonia content again, and if no further adjustments are indicated, insert the stopper and tubes and wire them in place. Store the adjusted supply of cuprammonium solution in a cool dark place. The bottle may be covered with a hood of black cloth, if desired.

13. Procedure

13.1 Weigh to the nearest 0.1 mg sufficient sample to give a 0.5% solution of the cellulose in cuam solvent. This is determined as follows:

$$W = \frac{0.94 \times V \times 0.5}{100 - M}$$

where:

W = weight of sample required

V = volume of liquid in the dissolving tube

M = moisture content (2% for desiccated samples)

0.94 = density of the cuprammonium solution.

13.2 Transfer the samples carefully from the weighing dish or watch glass to the glass dissolving bottle containing the stainless steel balls.

13.3 Add the standard cuprammonium solution in the following manner: with

the stopcock in the T-tube closed, open the pinchcock and allow the solution to flow out. When the flow becomes sluggish, owing to the drop in pressure of the gas in the bottle, pass a brisk stream of nitrogen gas through the horizontal arm of the T-tube to expel the air, and then open the stopcock to allow nitrogen to be drawn into the bottle.

13.4 Fill the tube to one-fourth the volume, and then by stirring or shaking wet out the specimen in the tube. Completely fill the tube with solution, so that when the stopper is inserted no air will be entrapped.

13.5 Rotate the tube at approximately 30 rpm by means of a suitable mechanical device for a period of 16 h. As light affects the solution, this should be done either in a dark room or on a device designed to exclude light.

13.6 Place the tube in a water bath at $25 \pm 0.5^\circ\text{C}$ ($77 \pm 1^\circ\text{F}$), and allow it to come to temperature equilibrium. After reaching equilibrium, remove from the bath, unstopper and fill the viscosimeter which is mounted in a glass jacket in the water bath.

13.7 The time of efflux between marks on the viscosimeter is then measured accurately to the nearest 0.2 s. Take the average results obtained with duplicate specimens as the apparent fluidity.

14. Calculations

14.1 Calculate the apparent fluidity of the dispersion from the following formula:

$$F = \frac{C}{0.95 \left(t - \frac{K}{t} \right)}$$

where:

F = apparent fluidity in rhes

t = time of efflux

0.94 = density of the cuprammonium solution

C and K = the instrumental constants

15. Precision and Bias

15.1 Precision and bias of this test method have not been established. Until a precision statement is generated, use standard statistical techniques in making any comparisons of test results for either *within-laboratory* or *between-laboratory* averages.

16. Notes

16.1 Available from Publications Office, ACGIH, Kemper Woods Center, 1330 Kemper Meadow Dr., Cincinnati OH 45240; tel: 513/742-2020.

16.2 Calibrated viscosimeters are available from Fisher Scientific Co., 585 Alpha Dr., Pittsburgh PA 15238; tel: 412/963-3300 (Cat. No. 13-617).

16.3 Uncalibrated viscosimeters can be calibrated by means of standard oils or other reference liquids according to the procedure of ASTM D 445, Method 6B.

16.4 Cupriethylene diamine is commercially available in 1.0 *M* concentration from SynMet Inc. P.O. Box 341593, Memphis TN

38184-1593; tel: 902/867-3031.

16.5 Calibrated viscosimeters can be purchased from the British Cotton Industry Research Assn., Shirley Institute, Didsbury, Manchester, England or Schmidt Manufacturing Co., 206 Emile Ave., P.O. Box 2484, Greenville SC 19602. Uncalibrated

viscosimeters may be purchased from the ACE Glass Co. Inc., Vineland NJ. (Cat. No. 1016).

16.6 Cuprammonium hydroxide reagent is commercially available from Anachemia Chemicals Ltd., Champlain NY 12919 or can be prepared as indicated in Section 12.

Electrical Resistance of Yarns

Developed in 1955 by AATCC Committee RA32; reaffirmed 1960, 1969, 1973, 1977, 1989, 2005; editorially revised 1974, 1984, 1985, 1997; revised 1982, 2000 (with title change); editorially revised and reaffirmed 1987, 1995.

1. Purpose and Scope

1.1 The purpose of this method is to determine the electrical resistance of any textile yarns containing natural or man-made fibers. The tendency of a textile yarn to accumulate electrical charges may depend upon the electrical resistance of the yarn. Due to the mechanism of conductance, this method is not applicable to yarns containing randomly situated stainless steel or other highly conductive fibers (refer to AATCC Method 76 for determination of surface electrical resistivity of fabrics).

2. Principle

2.1 Specimens of yarn are conditioned at specified relative humidity and temperature. The electrical resistance of the yarn held between two electrodes is measured by the use of an electrical resistance meter.

3. Terminology

3.1 **electrical resistance**, *n.*—the physical property of a material which is a measure of the ability of electrons to flow through it when a voltage is applied across two points on the material (resistance [in ohms] equal voltage [in volts] divided by current flow [in amperes]).

NOTE: This test method measures the electrical resistance of a material between two electrodes, and the results are expressed as resistance per unit of length per yarn strand, ohms per 10 mm.

4. Safety Precautions

NOTE: These safety precautions are for information purposes only. The precautions are ancillary to the testing procedures and are not intended to be all inclusive. It is the user's responsibility to use safe and proper techniques in handling materials in this test method. Manufacturers MUST be consulted for specific details such as material safety data sheets and other manufacturer's recommendations. All OSHA standard and rules must also be consulted and followed.

4.1 Good laboratory practices should

be followed. Wear safety glasses in all laboratory areas.

4.2 The safety recommendations provided by the manufacturer of the radioactive bar should be followed.

4.3 The radioactive bar emits alpha radiation which is externally harmless to the human body. The radioactive isotope polonium 210 is toxic and precaution should be exercised to prevent ingestion or inhalation of the solid material. Do not take the radioactive bar apart or touch the radioactive strip under the grid. If the strip is touched or handled, wash hands thoroughly at once. Return the device to the manufacturer when it loses its effectiveness as a static eliminator or for disposal if use is to be discontinued. **Do not discard as scrap.**

5. Apparatus and Materials

5.1 Electrical resistance meter equipped with either fixed position parallel plate electrodes or with separate variable position parallel plate electrodes (see 11.1). The concentric ring electrode system recommended for fabrics in AATCC Method 76 is not suitable for use in testing yarns.

5.2 Conditioning and test chamber (see 11.2).

5.3 Standard resistors (see 11.3).

5.4 Radioactive bar (see 11.4).

6. Test Specimens

6.1 The length of the test specimens depends on whether or not the electrodes used are in fixed or variable position. If the electrode system used provides for variable distances between the parallel plates, run a preliminary test to determine what distance between the plates provides the greatest sensitivity for resistance measurements for the meter being used.

6.2 To determine the uniformity of resistance along a single end of yarn, make measurements on at least 10 specimens of single strands.

6.3 For predicting the properties of woven or knitted fabrics to be made from yarn tested by this method, measurements should be made on multiple strands.

6.4 Prepare a minimum of three test specimens for each test, with parallel strands having the same tension, evenly spaced, with no overlap or touching along their length. When a limited supply of yarn is available, each specimen should contain 10 strands. If an adequate

supply of yarn is available, prepare larger specimens by winding 50-100 turns on a skein winder, then fastening the strands with adhesive tape to prepare lengths suitable for the electrode system used. The number of strands in the specimen must be the same for each test specimen for reproducible results. The resistance may also be dependent on the cross-section of the yarn bundle; thus, similarly manufactured fibers may yield yarns with different resistance, due to different numbers of filaments in the yarn bundle or different numbers of plies.

7. Procedure

7.1 Calibrate the electrical resistance meter according to the manufacturer's recommendations (see 11.3).

7.2 Condition the test specimens in a suitable testing chamber or conditioning room at the pre-selected relative humidity and temperature at which the electrical resistance of the yarn is to be measured.

7.2.1 For yarns which require antistatic treatments or whose electrostatic propensity is critical, measurements at 20% RH will be most meaningful. For special requirements other relative humidities may be used. For example, preconditioning at $21 \pm 2^\circ\text{C}$ is required for antistatic sheeting, film and textiles for use in hospital operating rooms (see 11.2.1). If it is necessary to measure electrical resistance under a broad range of conditions, additional tests may be run at 65% RH and at 24°C or other relevant conditions.

7.2.2 Condition the specimens at 24°C and at the predetermined relative humidity for a minimum of 4 h or until equilibrium is attained. A sufficient indication of equilibrium is no significant change of resistance on further conditioning. A significant change may be considered $\pm 5\%$ of the logarithm of the resistance ($\text{Log } R$).

7.3 Remove static charges from the surface of the yarn by passing a radioactive bar over both sides of the specimen (see 11.4).

7.4 Place the yarn test specimen in firm contact with the electrodes with the direction of the yarn perpendicular to the adjacent edges of the electrodes. Apply sufficient tension to hold the strands straight.

7.5 Measure the electrical resistance of the specimen according to the operating instructions and procedures for the particular resistance meter being used.

7.6 Allow the current to pass through the sample for a minimum period of 1 min and until a constant reading is obtained. The time to reach a constant read-

ing may vary with the applied voltage and with the resistance of the test specimen. High voltages for prolonged periods of time may damage the yarn.

7.7 For referee purposes, use 30-40 volts for a minimum period of 1 min or until a constant reading is obtained at an electrode separation of 10 mm.

7.8 Avoid the use of any electrically conductive liquids on either the yarn specimens or the apparatus.

8. Evaluation

8.1 Compute the resistance in ohms per 10 mm per strand of yarn.

$$R = \frac{S}{D} \times \frac{r_1 + r_2 + r_3 + \dots + r_n}{n} \times 10$$

where:

R = resistance in ohms per mm per strand

S = number of strands per specimen

D = distance between electrodes in mm

r = resistance of individual specimens containing S strands per specimen

n = total number of specimens tested (multiplication times 10 converts to the same scale as previously used for this test method)

9. Report

9.1 Report the result as the logarithm of the resistance ($\log R$) in ohms per 10 mm per strand of yarn and the temperature and relative humidity used (see 10.1).

10. Precision and Bias

10.1 *Precision*. Experience has shown that the reproducibility is within $\pm 10\%$ of the logarithm of the average resistance.

10.2 *Bias*. Electrical resistivity can be defined only in terms of a test method. There is no independent method for determining the true value. As a means of estimating this property, the method has no known bias.

11. Notes

11.1 The resistance meter in conjunction with the electrode system should be capable of measuring values in the range of 10^8 - 10^{15} ohms for any critical uses. Equipment that is capable of measuring values in the range of 10^8 - 10^{13} ohms is suitable for work where performance is known to be acceptable when the resistance is $< 10^{13}$ ohms.

11.1.1 An electrometer without built in electrodes, capable of measuring values in the range of 10^8 - 10^{15} ohms, is available from Keithley Instruments Inc., 28775 Aurora Rd., Cleveland OH 44139; tel: 440/248-0400.

11.1.1.1 External fixed-position parallel plate electrodes may be used with this instrument and may be built according to specifications described by Hayek & Chromey in *American Dyestuff Reporter* 40, 164-8 (1951). For more versatility these electrodes may be designed so that the distance between them may be adjusted from 5-50 mm.

11.1.2 Other resistance testers may be satisfactory for this test.

11.2 A conditioning and testing chamber is required capable of providing relative humidity control of $\pm 2\%$ (preferably effective over a range of 20-65% RH) and temperature control of $\pm 1^\circ\text{C}$ with circulating air. Since equilibration of a test specimen from the dry

versus the wet condition relative to the humidity of the test chamber may show hysteresis, it is recommended that specimens approach equilibrium from the dry side relative to the humidity in the test chamber whenever possible.

11.2.1 National Fire Protection Association, Standard NFPA Code #56 A-1973 Section 4663.

11.3 Standard resistors suitable for calibration of the electrical resistance meter are available from Victoreen LLC, 6000 Cochran Rd., Cleveland OH 44139-3395; tel: 440/248-9300; fax: 440/248-9301.

11.4 The radioactive bar, Staticmaster Ionizing Unit, Model 2 U 500, has been found to be suitable for the removal of electrostatic charges from fabrics and is available from NRD Inc., 2937 Alt. Blvd. North, Grand Island NY 14072; tel: 716/773-7634.

11.5 Accumulation of static electricity generally is greater the lower the relative humidity (and vice versa). Yarns which show a low degree of static accumulation at 40% RH may exhibit severe static accumulation at 20-25% RH, while yarns which exhibit static problems at 40% RH may exhibit a low degree of static accumulation at 65% RH. The relationship between the tendency for static accumulation and relative humidity varies with the specific antistatic agent, fiber, yarn construction, surface character, etc. Therefore, 40% RH may not provide significant performance properties of a yarn unless the tests are also run at 20 or 25% RH, an atmospheric condition not unusual in modern heated and air-conditioned buildings. Complete information may also require information on resistance at the upper level of 65% RH.

11.6 For more detailed information regarding the measurement of resistances, see ASTM D 257, Tests for D-C Resistance or Conductance of Insulating Materials.

Drycleaning: Durability of Applied Designs and Finishes

Developed in 1957 by AATCC Committee RA43; revised 1963, 1968, 1970, 1973; reaffirmed 1976, 1979, 1989, 2000, 2005; editorially revised 1969, 1983, 1986, 1993, 1995, 2004; editorially revised and reaffirmed 1985, 1994.

1. Purpose and Scope

1.1 This test method indicates the effect of repeated (see 10.1) drycleanings on the durability of applied-design or finish on textiles and other materials. It is also applicable for evaluating the durability of applied design materials and finishing agents manufactured for use on fabrics and other products intended for apparel and household use which are renovated in consumer service by commercial drycleaning procedures. This test method is to be used for evaluating the resistance of colors to spot and stain removal procedures used by the drycleaner.

1.2 This test method is not intended for evaluating colorfastness to drycleaning. For colorfastness properties use AATCC Test Method 132, Colorfastness to Drycleaning.

2. Principle

2.1 A specimen is agitated in a solution of solvent and a drycleaning detergent with steel balls to simulate the kind of mechanical action that occurs in a drycleaning machine. A large specimen is provided to produce a correlation with commercial conditions.

3. Terminology

3.1 **drycleaning**, n.—the cleaning of fabrics with organic solvents such as petroleum solvent, perchloroethylene or fluorocarbon.

NOTE: The process also includes adding detergent and moisture to the solvent, up to 75% relative humidity, and hot tumble drying to 71°C (160°F).

4. Safety Precautions

NOTE: These safety precautions are for information purposes only. The precautions are ancillary to the testing procedures and are not intended to be all inclusive. It is the user's responsibility to use safe and proper techniques in handling materials in this test method. Manufacturers MUST be consulted for specific details such as material safety data sheets and other manufacturer's recommenda-

tions. All OSHA standards and rules must be consulted and followed.

4.1 Good laboratory practices should be followed. Wear safety glasses in all laboratory areas.

4.2 All chemicals should be handled with care.

4.3 Perchloroethylene is toxic by inhalation, by repeated contact with the skin and by ingestion. It should be used only in a well vented atmosphere. Toxicology studies with laboratory animals have shown evidence of cancer in rats and mice exposed to perchloroethylene vapors at 100-400 ppm concentrations for prolonged times. Fabric saturated with this solvent should be dried in an adequately ventilated hood. Use chemical goggles or face shield, impervious gloves and an impervious apron when handling perchloroethylene.

4.4 An eyewash/safety shower should be located nearby and an organic vapor respirator should be readily available for emergency use.

4.5 Exposure to chemicals used in this procedure must be controlled at or below levels set by governmental authorities (e.g., Occupational Safety and Health Administration's [OSHA] permissible exposure limits [PEL] as found in 29 CFR 1910.1000 of January 1, 1989). In addition, the American Conference of Governmental Industrial Hygienists (ACGIH) Threshold Limit Values (TLVs) comprised of time weighted averages (TLV-TWA), short term exposure limits (TLV-STEL) and ceiling limits (TLV-C) are recommended as a general guide for air contaminant exposure which should be met (see 10.9).

5. Apparatus and Materials

5.1 Launder-Ometer (see 10.7).

5.2 Stainless steel cylindrical containers, 203 × 89 mm (8.0 × 3.5 in.) in diameter equipped with solvent-resistant rings (see 10.7).

5.3 Teflon liners (see 10.7).

5.4 Metal adapters (to hold containers on shaft of Launder-Ometer) (see 10.7 and 10.8).

5.5 Stainless steel balls, 6.3 mm (0.25 in.) (see 10.7).

5.6 Gray Scale for Color Change (see 10.2).

5.7 Perchloroethylene, drycleaning grade.

5.8 Drycleaning detergent (see 10.3).

5.9 Hand iron, steam press or flatbed press.

6. Test Specimens

6.1 One test specimen is required. The size of the specimen conforms to the weight range of the product tested as follows:

up to 135 g/m²: 203 × 203 mm
(4 oz/yd²: 8 × 8 in.)

139 to 203 g/m²: 152 × 152 mm
(4.1 to 6.0 oz/yd²: 6 × 6 in.)

207 to 305 g/m²: 127 × 127 mm
(6.1 to 9.0 oz/yd²: 5 × 5 in.)

over 305 g/m²: 102 × 102 mm
(9 oz/yd²: 4 × 4 in.)

6.2 For water-repellency evaluations, a minimum specimen size of 178 mm (7 in.) square is necessary (i.e., for AATCC Method 22, Water Repellency: Spray Test).

7. Procedure

7.1 Run Number 1: Place the specimen in a steel container with 150 mL of perchloroethylene, 1 mL drycleaning detergent (see 10.4) and 100 steel balls. Seal the container (see 10.5), clamp in the Launder-Ometer and run at room temperature (27°C; 80°F) for 10 min. Drain.

7.2 Run Number 2: Replace the solvent with an equal amount of perchloroethylene without detergent and run another 10 min. Drain.

7.3 Run Number 3: Repeat Run Number 2. Remove the specimen, blot thoroughly between paper towels and air dry.

7.4 Finish the specimen by one of the following methods:

7.4.1 Hand Pressing [for all except pile fabrics (see 10.6)]—Cover with a damp muslin cloth, weighing 135-153 g/m² (4.0-4.5 oz/yd²), previously saturated with water and wrung out so as to retain moisture equal to approximately 75% of its dry weight and press with a hand iron having a temperature between 135-150°C (275-300°F) until dry.

7.4.2 Steam Pressing [for all except pile fabrics (see 10.6)]—A hotbed or polished metal-top type press *for flat fabrics*, or a cloth-top type press *for rough crepes*, operating at a steam pressure of between 448 and 482 kPa (65-70 psi). Lower the head of the machine and hold in contact with the fabric. During this period admit steam from the buck of the press for a period of 5-10 s.

8. Evaluation and Classification

8.1 Durability of Applied Designs—Rate the specimens containing flock,

metallic or other applied designs for appearance as follows:

Grade A5—negligible or no change in appearance.

Grade A4—slightly changed in appearance.

Grade A3—noticeably changed in appearance.

Grade A2—considerably changed in appearance.

Grade A1—much changed in appearance.

8.2 Durability of Fabric Handle—Rate specimens for change in handle as follows:

Grade B5—negligible or no change in handle.

Grade B4—slightly changed in handle.

Grade B3—noticeably changed in handle.

Grade B2—considerably changed in handle.

Grade B1—much changed in handle.

8.3 Finish Performance—Evaluate finish performance characteristics in accordance with AATCC Method 22, Water Repellency: Spray Test.

9. Precision and Bias

9.1 *Precision.* Precision for this test method has not been established. Until a precision statement is generated for this test method, use standard statistical techniques in making any comparisons of test results for either *within-laboratory* or *between-laboratory* averages.

9.2 *Bias.* The durability of applied designs and finishes to drycleaning can be defined only in terms of a test method. There is no independent method for determining the true value. As a means of estimating this property, the method has no known bias.

10. Notes

10.1 This test is based on an extensive series of interlaboratory tests which showed good correlation between laboratory tests and commercial drycleanings for as many as three repeated drycleanings. Since a major loss of finish material occurs in the first drycleaning, a single application of this test furnishes a good indication of the effect of repeated

drycleanings.

10.2 Available from AATCC, P.O. Box 12215, Research Triangle Park NC 27709; tel: 919/549-8141; fax: 919/549-8933; e-mail: orders@aatcc.org.

10.3 Drycleaning detergent such as Detergent Honey available from AATCC, P.O. Box 12215, Research Triangle Park NC 27709; tel: 919/549-8141; fax: 919/549-8933; e-mail: orders@aatcc.org.

10.4 Where residual soap affects the performance of the finish (e.g., where water-repellency evaluation is impaired by the presence of detergent) the detergent may be omitted from the test solution, but it is an artificial condition.

10.5 The jars need not be immersed in a water bath as required in washfastness tests.

10.6 Pile fabrics need only be air dried by any suitable means.

10.7 Available from SDL Atlas L.L.C., 1813A Associate Lane, Charlotte NC 28217; tel: 704/329-0911; fax: 704/329-0914; e-mail: info@sdlatlas.com.

10.8 Necessary on older models.

10.9 Available from Publications Office, ACGIH, Kemper Woods Center, 1330 Kemper Meadow Dr., Cincinnati OH 45240; tel: 513/742-2020.

Smoothness of Seams in Fabrics after Repeated Home Laundering

Developed in 1962 by AATCC Committee RA61; reaffirmed 1969, 1973; editorially revised 1974, 1983, 1985, 1986, 1991, 1997, 2004, 2005; editorially revised and reaffirmed 1978, 1984, 2001; revised 1970, 1975, 1981, 1989 (with title change), 1992, 1996, 2003. Technically equivalent to ISO 7770.

1. Purpose and Scope

1.1 This test method is designed to evaluate the smoothness appearance of seams in fabrics after repeated home laundering.

1.2 Any washable fabric may be evaluated for seam smoothness using this method.

1.3 Fabrics of any construction, such as woven, knit and nonwoven, may be evaluated according to this method.

1.4 Techniques for seaming are not outlined, since the purpose is to evaluate fabrics as they will be supplied from manufacturing or as ready for use. Furthermore, seaming techniques would be controlled by fabric properties.

2. Principle

2.1 Seamed fabric specimens are subjected to standard home laundering practices. A choice is provided of hand or machine washing, alternative machine wash cycles and temperatures and alternative drying procedures. Evaluation is performed using a standard lighting and viewing area by rating the appearance of specimens in comparison with appropriate reference standards.

3. Terminology

3.1 **ballast**, n.—*in procedures for processing or testing of textiles*, material that is used to bring the total weight or volume of the textiles to an amount specified in the procedure.

3.2 **dryer creases**, n.—sharp folds or lines running in any direction in a laundered or dried specimen.

NOTE: Dryer creases are an unintended result of restricted movement of specimens in the washer or the dryer.

3.3 **durable press**, adj.—having the ability to retain substantially the initial shape, flat seams, pressed-in creases and unwrinkled appearance during use and after laundering or drycleaning.

3.4 **laundering**, n.—*of textile materials*, a process intended to remove soils

and/or stains by treatment (washing) with an aqueous detergent solution and normally including rinsing, extracting and drying.

3.5 **seam smoothness**, n.—*in fabrics*, the visual impression of planarity of a seamed specimen quantified by comparison with a set of reference standards.

4. Safety Precautions

NOTE: These safety precautions are for information purposes only. The precautions are ancillary to the testing procedures and are not intended to be all inclusive. It is the user's responsibility to use safe and proper techniques in handling materials in this test method. Manufacturers MUST be consulted for specific details such as material safety data sheets and other manufacturer's recommendations. All OSHA standards and rules must also be consulted and followed.

4.1 Good laboratory practices should be followed. Wear safety glasses in all laboratory areas.

4.2 The 1993 AATCC Standard Reference Detergent may cause irritation. Care should be taken to prevent exposure to skin and eyes.

4.3 All chemicals should be handled with care.

4.4 Manufacturer's safety recommendations should be followed when operating laboratory testing equipment.

5. Uses and Limitations

5.1 This test method is designed to be used only for evaluating the appearance of washable seamed fabrics after repeated home laundering.

5.2 The test procedure is designed to reflect the capabilities of home laundry equipment which is currently used by consumers. In general, it is preferable to conduct the test under relatively severe laundering conditions.

5.3 Prints and patterns may mask the mussiness present in seamed fabrics. The rating process is, however, based on the visual appearance of specimens including such effects.

5.4 The small specimen sizes used for fabric tests occasionally will cause wrinkles or creases (dryer creases) to develop which are not considered to be characteristic of fabric performance in use. Precautions are given in the text of the method to reduce the occurrence of dryer creases.

5.5 The interlaboratory reproducibility of the results of this test method depends

upon mutual agreement by users of the method on the washing and drying conditions as outlined in 8.1.

6. Apparatus and Materials

6.1 Automatic washing machine (see 12.1).

6.2 Automatic tumble dryer (see 12.1).

6.3 Drip dry and line dry facilities.

6.4 A 9.5 L (10.0 qt) pail.

6.5 1993 AATCC Standard Reference Detergent (see 12.2 and 12.8).

6.6 Ballast of $92 \times 92 \pm 3$ cm ($36 \times 36 \pm 1$ in.) hemmed pieces of bleached cotton sheeting (Wash load ballast type 1) or 50/50 polyester/cotton plain weave (Wash load ballast type 3) (see 12.3).

6.7 Lighting and evaluation area in an otherwise darkened room using the overhead lighting arrangement shown in Fig. 1 (see 12.4). It has been the experience of many observers that light reflected from the side walls near the viewing board can interfere with the rating results. It is recommended that the side walls be painted matte black (85° gloss less than 5 units) or that blackout curtains be mounted on both sides of the viewing board to eliminate the reflective interference.

6.8 Standard AATCC Photographic Seam Smoothness Replicas prepared for rating single- and double-needle seams (see Fig. 2 and 12.2). The reproduction shown in Fig. 2 should not be used for rating.

6.9 Steam or dry iron with appropriate fabric temperature settings.

6.10 Detergent (for hand wash).

6.11 Scale with at least 5 kg or 10 lb capacity.

7. Test Specimens

7.1 Three representative 38×38 cm (15×15 in.) fabric specimens cut parallel to the fabric length and width are prepared. Where possible, each specimen should contain different groups of lengthwise and widthwise yarns. The specimens should be marked to indicate the lengthwise direction. If fraying is expected in laundering, see 12.5.

7.1.1 The seam specimens are prepared as in 7.1 so that existing seams run through the middle of each specimen after it is cut in the fabric length direction. If the fabric is wrinkled, it may be smoothed by appropriate ironing prior to laundering (see Safe Ironing Temperature Guide in ASTM D 2724, Standard Test Methods for Bonded, Fused and Lami-

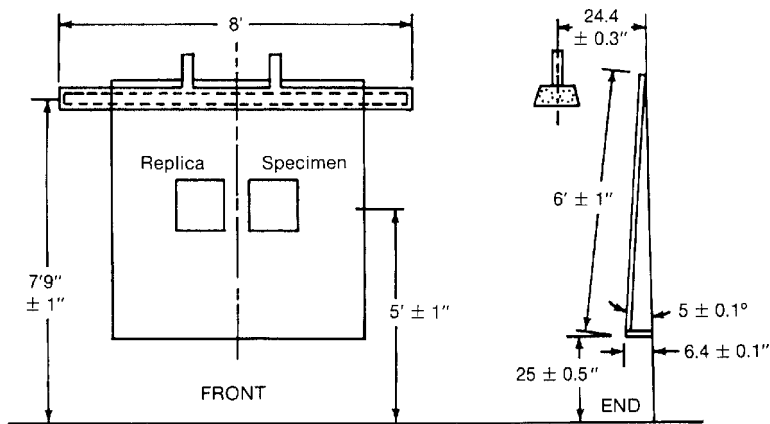

Fig. 1—Lighting equipment for viewing test specimens.

Materials list: (a) Two 8-ft Type F96 CW (Cool White) preheat Rapid Start fluorescent lamps (without baffle or glass), (b) One white enamel reflector (without baffle or glass), (c) One general type swatch mount, spring loaded. Fabricate using light sheet metal (22 ga), (d) One ¼ in. plywood mounting board painted to match No. 2 gray chip on AATCC Gray Scale for Staining.

nated Apparel Fabrics, and 12.6). Care should be taken to avoid altering quality of the seam itself.

8. Procedure

8.1 Tables II, III and IV summarize the alternate washing and drying conditions and settings. Additional information on the machine and laundering conditions may be found in the monograph, *Standardization of Home Laundry Test Conditions*, elsewhere in this TECHNICAL MANUAL.

8.1.1 It is recognized that special cycles or features are available on current washing machines and dryers to achieve

improved performance on certain items; i.e., gentle cycles with reduced agitation to protect delicately constructed items, and durable press cycles, with cool-down or cold rinses and reduced spin speeds, to minimize wrinkling. In evaluating seam appearance, however, the more severe Normal or Cotton Sturdy machine cycle is considered most appropriate. If modifications to any of the cycles (see 8.2) are used, these must be reported in the results (see Section 10).

8.2 Standard washing.

8.2.1 Hand Wash—(see 12.7). Dissolve 20.0 ± 0.1 g of 1993 AATCC Standard Reference Detergent in 7.57 ± 0.06 L (2.00 ± 0.02 gal) of water at $41 \pm 3^\circ\text{C}$

($105 \pm 5^\circ\text{F}$) in a 9.5 L (10.0 qt) pail and then add the three fabric test specimens. Wash for 2.0 ± 0.1 min with no twisting or wringing. Rinse once using 7.57 ± 0.06 L (2.00 ± 0.02 gal) of water at $41 \pm 3^\circ\text{C}$ ($105 \pm 5^\circ\text{F}$). Remove the specimens and dry by Procedure C, Drip (see 8.3.3).

8.2.2 Machine Wash—Use specified water level, the selected water temperature for the washing cycle and a rinse temperature of less than 29°C (85°F). If this rinse temperature is not attainable, record available rinse temperature.

8.2.3 Add 66 ± 0.1 g of 1993 AATCC Standard Reference Detergent. In soft water areas this may be reduced to avoid excessive sudsing, but in that case the amount should be stated in the report of test results.

8.2.4 Add test specimens and enough ballast to make a 1.8 ± 0.06 kg (4.00 ± 0.13 lb) load. Set the washer for the selected washing cycle and time (see Tables II and III). Normal or Cotton Sturdy is recommended. For very critical evaluation and in arbitration, limit the number of specimens per washer load to those from one sample.

8.2.5 For specimens to be dried by Procedures A, B or D, allow washing to proceed automatically through the final spin cycle. Remove the test specimens *immediately* after the final spin cycle, separate tangled pieces, taking care to minimize distortion and dry by Procedure A, B or D (see Tables II and IV).

8.2.6 For specimens to be dried by Procedure C, Drip Dry, remove the specimens from the washer just before the water begins to drain for the final rinse cycle. Remove specimens soaking wet.

8.2.7 Washer creases. Specimens may be in a folded or creased conformation after removal from the washer. Such

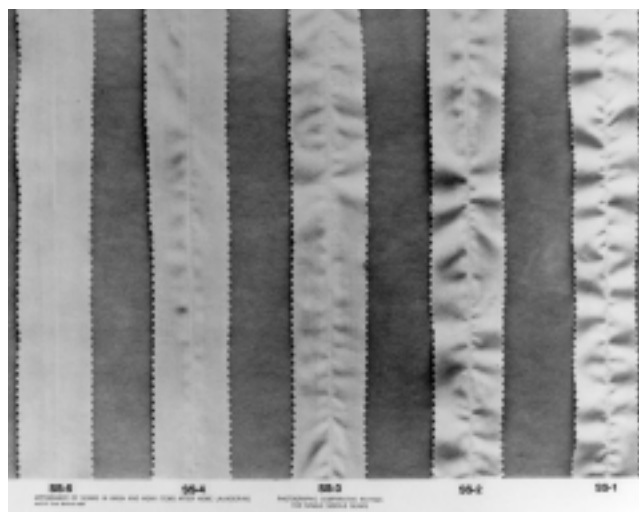

A. For single needle seams.

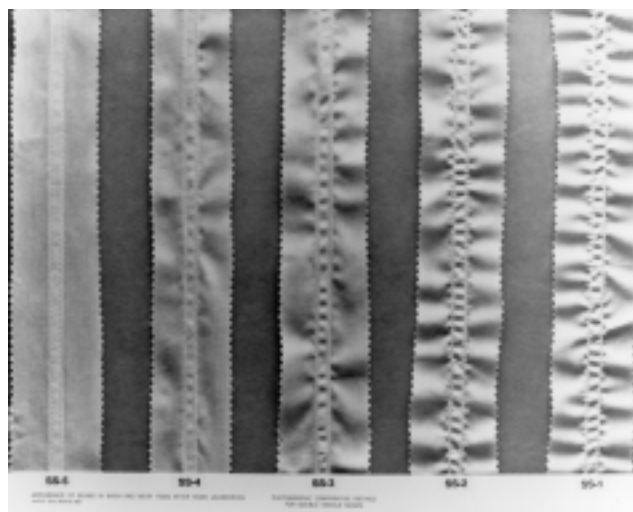

B. For double needle seams.

Fig. 2—AATCC photographic seam smoothness replicas.

Table I—Wash Load Ballast: Finished Fabric Specification

Fiber Content	Wash Load Ballast Type 1	Wash Load Ballast Type 3
	100% Cotton	50/50 ± 3% poly/cotton
Yarns	16/1 ring spun	30/2 ring spun
Fabric Construction	52 (± 2) × 48 (± 2)	48 (± 2) × 48 (± 2)
Fabric Weight	155 ± 5 g/m ² (4.55 ± 0.15 oz/yd ²)	155 ± 5 g/m ² (4.55 ± 0.15 oz/yd ²)
Piece Size	92.0 × 92.0 ± 3 cm (36.0 × 36.0 ± 1 in.)	92.0 × 92.0 ± 3 cm (36.0 × 36.0 ± 1 in.)
Piece Weight	130 ± 10 g	130 ± 10 g

Table II—Alternative Washing and Drying Conditions (see 8.1)

Machine Cycle	Wash Temperatures	Drying Procedures
Hand, in pail	(III) 41 ± 3°C (105 ± 5°F)	(A) Tumble:
(1) Normal/Cotton Sturdy	(IV) 49 ± 3°C (120 ± 5°F)	i. Cotton Sturdy
(2) Delicate	(V) 60 ± 3°C (140 ± 5°F)	ii. Delicate
(3) Permanent Press		iii. Permanent Press
		(B) Line
		(C) Drip
		(D) Screen

Table III—Washing Machine Conditions (see 8.1)

	Normal/Cotton Sturdy	Delicate	Permanent Press
Water Level	18 ± 1 gal	18 ± 1 gal	18 ± 1 gal
Agitator Speed	179 ± 2 spm	119 ± 2 spm	179 ± 2 spm
Washing Time	12 min	8 min	10 min
Spin Speed	645 ± 15 rpm	430 ± 15 rpm	430 ± 15 rpm
Final Spin Cycle	6 min	4 min	4 min

Table IV—Dryer Conditions (see 8.1)

	Cotton Sturdy	Delicate	Durable Press
Exhaust Temperature	High 66 ± 5°C (150 ± 10°F)	Low < 60°C (140°F)	High 66 ± 5°C (150 ± 10°F)
Cool Down Time	10 min	10 min	10 min

creases present after laundering should be straightened out prior to drying.

8.3 Drying.

8.3.1 (A) Tumble Dry. Place the washed load (test specimens and ballast) in the tumble dryer and set the temperature control to generate the correct exhaust temperatures as specified in Table IV. For fibers that are heat sensitive, lower temperatures consistent with producers' recommendations are required, and must be reported. Operate the dryer until the total load is dry. Remove the load immediately after the machine stops. Avoid overdrying. Static cling becomes a problem with overdrying, particularly with lightweight fabrics, because it prevents the specimens from tumbling freely.

8.3.2 (B) Line Dry. Hang each fabric specimen by two corners with the fabric length in the vertical direction. Allow specimens to hang in still air at room temperature until dry.

8.3.3 (C) Drip Dry. Hang each dripping wet fabric specimen by two corners with the fabric length in the vertical direction. Allow specimens to hang in still air at

room temperature until dry.

8.3.4 (D) Screen Dry. Spread each specimen on a horizontal screen or perforated surface, removing wrinkles but not distorting or stretching the specimen. Allow the specimens to dry in still air at room temperature.

8.3.5 Dryer creases. If specimens are folded or creased after any drying cycle but the last, they should be rewet and an attempt should be made to remove the creases prior to additional washing and drying. No attempt to remove wrinkles or creases should be made after the fifth cycle of drying.

8.4 Repeat the selected washing and drying cycles four more times or to an agreed number of cycles.

8.5 Prior to evaluation, precondition and then condition test specimens as directed in ASTM D 1776, Standard Practice for Conditioning and Testing Textiles (see 12.6). Condition the test specimens for a minimum of 4 h in the standard atmosphere for textile testing [21 ± 1°C (70 ± 2°F) and 65 ± 2% RH], hanging each specimen from two corners with the fab-

ric length in vertical direction to avoid distortion.

9. Evaluation

9.1 Three trained observers should rate each test specimen independently.

9.2 The overhead fluorescent light should be the only light source for the viewing board. All other lights in the room should be turned off.

9.3 The observer is to stand directly in front of the specimen 120 ± 3 cm (4 ft ± 1 in.) away from the board. It has been found that normal variations in the height of the observer above and below the arbitrary 1.5 m (5.0 ft) eye level have no significant effect on the grade given.

9.4 Mount the test specimen on the viewing board with the seam in the vertical direction. Place the appropriate single- or double-needle standard seam smoothness (SS) replicas beside the specimen to facilitate comparative rating.

9.5 Confine observations to the area influenced by the seam and disregard the appearance of the surrounding fabric.

9.6 Assign the numerical grade of the photographic standard which most nearly matches the appearance of the seam in the test specimen.

9.7 A seam smoothness grade of SS-5 is equivalent to the appearance of Standard No. 5, the best level of seam appearance; a seam smoothness grade of SS-1 is equivalent to that of Standard No. 1, which represents a very poor level of seam appearance.

10. Report

10.1 Seam smoothness in fabric.

10.1.1 Average the nine observations made on each test fabric (three grades on each of three test specimens). Report the average to the nearest tenth of a grade. This average is the unit of measure of this test method.

10.1.2 Report whether single- or double-needle seams were rated.

10.2 State washing procedure (Arabic number and Roman numeral) and drying procedure (capital letter and subscript) from Table II, as well as type of wash load ballast (Arabic number). Any deviations from stated procedures, such as use of a modified wash cycle, a reduced amount of detergent or a higher than usual load limit, should be explained completely.

10.2.1 For example, seam smoothness grade SS-3.8 (1-IV-A(i)-3) denotes a seam smoothness grade of 3.8 for specimens washed using a Normal (Cotton Sturdy) cycle at 49°C (120°F) with Wash load ballast type 3 and tumble dried using the Normal (Cotton Sturdy) cycle.

11. Precision and Bias

11.1 *Interlaboratory Study.* Tests for seam appearance were conducted in 1993 under washing condition 1-III-A and drying condition 1-IV-A of Table II, with data from six laboratories analyzed for double-needle seams. Three raters in each laboratory independently rated the same three specimens from each of the fabrics, yielding nine grades to average for each test result, as required by the method.

11.2 Precision.

11.2.1 When two or more laboratories wish to compare test results, it is recommended that laboratory level be established between them prior to beginning test comparisons.

11.2.2 Double-Needle Seams. Components of variance are given in Table V, and critical differences for single fabric and for multiple fabric comparisons are given in Tables VI and VII, respectively.

11.2.3 If comparisons are made between laboratories on a single fabric, critical differences in Table VI are used.

11.2.4 If comparisons are made between laboratories on multiple fabrics, critical differences in Table VII are used.

11.2.5 If two laboratories are shown to be in statistical control and operating at comparable levels, the magnitude of applicable critical differences may be less than those given in these tables, and may be determined by data from comparison trials between them.

11.3 *Bias.* The value of seam appearance can be defined only in terms of a test method. There is no independent method for determining the true value. This test method has no known bias.

Table V—Components of Variance (as variance)

Component	Variance
Laboratory	0.113
FL Interaction	0.031
Specimen (FRL)	0.191

Table VI—Critical Differences for Single Fabric Comparisons (95% probability)

Within Laboratory	Between Laboratory
0.70	1.16

Table VII—Critical Differences for Multiple Fabric Comparisons (95% probability)

Within Laboratory	Between Laboratory
0.70	1.26

12. Notes

12.1 Contact AATCC, P.O. Box 12215, Research Triangle Park NC 27709; tel: 919/549-8141; fax: 919/549-8933; e-mail: orders@aatcc.org, for model number(s) and source(s) of approved washer(s) and dryer(s). Any other washer or dryer which is known to give comparable results may be used. Washing machine conditions given in Table III represent the actual speeds and times available on the current specified model(s). Other washers may vary in one or more of these settings. Dryer machine conditions given in Table IV represent the actual temperatures and cool-down times available on the current specified model(s). Other dryers may vary in one or more of these settings.

12.2 Available from AATCC, P.O. Box 12215, Research Triangle Park NC 27709; tel: 919/549-8141; fax: 919/549-8933; e-mail: orders@aatcc.org.

12.3 Ballast are available from Testfabrics Inc., P.O. Box 26, 415 Delaware St., W. Pittston PA 18643; tel: 570/603-0432; fax: 570/603-0433; e-mail: testfabric@aol.com; and Textile Innovators Corp., div. of SDL Atlas L.L.C., P.O. Box 8, 101 Forest St., Windsor NC; tel: 252/794-9703; fax: 252/794-9704; e-mail: tic@sdlatlas.com. Ballast fabrics should conform to specifications in Table I.

12.4 The use of 8-ft fixtures for viewing laundered specimens is specified in this method. It is recognized, however, that physical limitations in certain laboratories will prevent the use of 8-ft fixtures. In those situations, 4-ft lights may be used.

12.5 If excessive fraying occurs in laundering, specimen edges should be pinked, slashed or stitched as appropriate. If edges of laundered specimens appear distorted, clip as necessary before evaluating.

12.6 ASTM standards are available from ASTM, 100 Barr Harbor Dr., West Conshohocken PA 19428; tel: 610/832-9500; fax: 610/832-9555.

12.7 Like other hand wash procedures, this procedure has inherent limitations; e.g., limited reproducibility of the type of action involved due to the human element.

12.8 The AATCC Technical Center conducted a study to compare the 1993 AATCC Standard Reference Detergent, AATCC Standard Reference Detergent 124 and two different types of fabrics (current and proposed) to be used as ballast, under the following test conditions:

Machine cycle: (1)—Normal/Cotton Sturdy
Washing Temp: (V)— $60 \pm 3^\circ\text{C}$ ($140 \pm 5^\circ\text{F}$)
Drying Procedure: (A)i—Tumble dry, cotton sturdy cycle
Fabrics tested: White Twill (100% cotton)
Beige Twill (100% cotton)
Grey Poplin (100% cotton)
Blue Twill (50/50 poly/cotton)

No significant differences were found in the results using either detergent or ballast load fabrics.

Retention of Creases in Fabrics after Repeated Home Laundering

Developed in 1963 by AATCC Committee RA61; revised 1975, 1979, 1987, 1989 (with title change), 1992, 1996, 2003; reaffirmed 1969, 1973; editorially revised 1974, 1985, 1986, 1991, 1997, 2004, 2005; editorially revised and reaffirmed 1984 (new title), 2001. Technically equivalent to ISO 7769.

1. Purpose and Scope

1.1 This test method is designed to evaluate the retention of pressed-in creases in fabrics after repeated home laundering.

1.2 Any washable fabric may be evaluated for crease retention using this method.

1.3 Fabrics of any construction, such as woven, knit and nonwoven, may be evaluated according to this method.

1.4 Techniques for creasing are not outlined, since the purpose is to evaluate fabrics as they will be supplied from manufacturing or as ready for use. Furthermore, creasing techniques would be controlled by fabric properties.

2. Principle

2.1 Creased fabric specimens are subjected to standard home laundering practices. A choice is provided of hand or machine washing, alternative machine wash cycles and temperatures and alternative drying procedures. Evaluation is performed using a standard lighting and viewing area by rating the appearance of specimens in comparison with appropriate reference standards.

3. Terminology

3.1 **ballast**, n.—*in procedures for processing or testing of textiles*, material that is used to bring the total weight or volume of the textiles to an amount specified in the procedure.

3.2 **crease retention**, n.—*in fabrics*, the visual impression of an inserted crease quantified by comparison with a set of reference standards.

3.3 **dryer creases**, n.—sharp folds or lines running in any direction in a laundered or dried specimen.

NOTE: Dryer creases are an unintended result of restricted movement of specimens in the washer or the dryer.

3.4 **durable press**, adj.—having the ability to retain substantially the initial shape, flat seams, pressed-in creases and

unwrinkled appearance during use and after laundering or drycleaning.

3.5 **laundering**, n.—*of textile materials*, a process intended to remove soils and/or stains by treatment (washing) with an aqueous detergent solution and normally including rinsing, extracting and drying.

4. Safety Precautions

NOTE: These safety precautions are for information purposes only. The precautions are ancillary to the testing procedures and are not intended to be all inclusive. It is the user's responsibility to use safe and proper techniques in handling materials in this test method. Manufacturers MUST be consulted for specific details such as material safety data sheets and other manufacturer's recommendations. All OSHA standards and rules must also be consulted and followed.

4.1 Good laboratory practices should be followed. Wear safety glasses in all laboratory areas.

4.2 The 1993 AATCC Standard Reference Detergent may cause irritation. Care should be taken to prevent exposure to skin and eyes.

4.3 All chemicals should be handled with care.

4.4 Manufacturer's safety recommendations should be followed when operating laboratory testing equipment.

4.5 When evaluating crease retention, use of a lamp with a shield can aid in prevention of burns that could result from lamp heat.

5. Uses and Limitations

5.1 This test method is designed to be used only for evaluating the appearance of washable creased fabrics after repeated home laundering.

5.2 The test procedure is designed to reflect the capabilities of home laundry equipment which is currently used by consumers. In general, it is preferable to conduct the test under relatively severe laundering conditions.

5.3 Prints and patterns may mask the appearance of a crease. The rating process is, however, based on the visual appearance of specimens including such effects.

5.4 The small specimen sizes used for fabric tests occasionally will cause wrinkles or creases (dryer creases) to develop which are not considered to be characteristic of fabric performance in use. Precautions are given in the text of the

method to reduce the occurrence of dryer creases.

5.5 The interlaboratory reproducibility of the results of this test method depends upon mutual agreement by users of the method on the washing and drying conditions as outlined in 8.1.

6. Apparatus and Materials

6.1 Automatic washing machine (see 12.1).

6.2 Automatic tumble dryer (see 12.1).

6.3 Drip dry and line dry facilities.

6.4 A 9.5 L (10.0 qt) pail.

6.5 1993 AATCC Standard Reference Detergent (see 12.2 and 12.8).

6.6 Ballast of $92 \times 92 \pm 3$ cm ($36 \times 36 \pm 1$ in.) hemmed pieces of bleached cotton sheeting (Wash load ballast type 1) or 50/50 polyester/cotton plain weave (Wash load ballast type 3) (see 12.3).

6.7 Lighting and evaluation area in an otherwise darkened room using the overhead lighting arrangement shown in Fig. 1 (see 12.4). It has been the experience of many observers that light reflected from the side walls near the viewing board can interfere with the rating results. It is recommended that the side walls be painted matte black (85° gloss less than 5 units) or that blackout curtains be mounted on both sides of the viewing board to eliminate the reflective interference.

6.8 A 500-watt DXC (RFL-2) flood lamp with reflector and light shield, positioned as shown in Fig. 2, for evaluating crease retention.

6.9 Standard AATCC Three-Dimensional Crease Replicas, set of five (see Fig. 3 and 12.2).

6.10 Steam or dry iron with appropriate fabric temperature settings.

6.11 Detergent (for hand wash).

6.12 Scale with at least 5 kg or 10 lb capacity.

7. Test Specimens

7.1 Three representative 38×38 cm (15×15 in.) fabric specimens cut parallel to the fabric length and width are prepared. Where possible, each specimen should contain different groups of lengthwise and widthwise yarns. The specimens should be marked to indicate the lengthwise direction. If fraying is expected in laundering, see 12.5.

7.1.1 The specimens are prepared with a pressed-in crease through the middle in the fabric length direction. If the fabric is

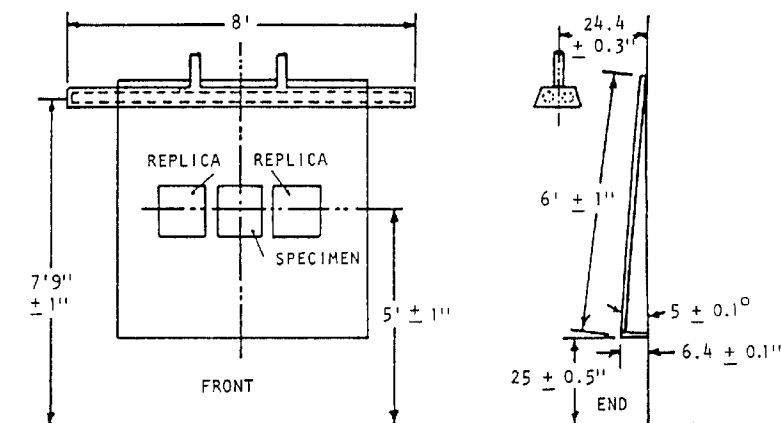

Fig. 1—Lighting equipment for viewing test specimens.

Materials list: (a) Two 8-ft Type F96 CW (Cool White) preheat Rapid Start fluorescent lamps (without baffle or glass), (b) One white enamel reflector (without baffle or glass), (c) One general type swatch mount, spring loaded. Fabricate using light sheet metal (22 ga), (d) One ¼ in. plywood mounting board painted to match No. 2 gray chip on AATCC Gray Scale for Staining.

wrinkled, it may be smoothed by appropriate ironing prior to laundering (see Safe Ironing Temperature Guide in ASTM D 2724, Standard Test Methods for Bonded, Fused and Laminated Apparel Fabrics, and 12.6). Care should be taken to avoid altering quality of the crease itself.

8. Procedure

8.1 Tables II, III and IV summarize the alternate washing and drying conditions and settings. Additional information on the machine and laundering conditions may be found in the monograph, *Standardization of Home Laundry Test Conditions*, elsewhere in this TECHNICAL MANUAL.

8.1.1 It is recognized that special cycles or features are available on current

washing machines and dryers to achieve improved performance on certain items; i.e., gentle cycles with reduced agitation to protect delicately constructed items, and durable press cycles, with cool-down or cold rinses and reduced spin speeds, to minimize wrinkling. In evaluating crease retention, however, the more severe Normal or Cotton Sturdy machine cycle is considered most appropriate. If modifications to any of the cycles (see 8.2) are used, these must be reported in the results (see Section 10).

8.2 Standard washing.

8.2.1 Hand Wash—(see 12.7). Dissolve 20.0 ± 0.1 g of 1993 AATCC Standard Reference Detergent in 7.57 ± 0.06

L (2.00 ± 0.02 gal) of water at $41 \pm 3^\circ\text{C}$ ($105 \pm 5^\circ\text{F}$) in a 9.5 L (10.0 qt) pail and then add the three fabric test specimens. Wash for 2.0 ± 0.1 min with no twisting or wringing. Rinse once using 7.57 ± 0.06 L (2.00 ± 0.02 gal) of water at $41 \pm 3^\circ\text{C}$ ($105 \pm 5^\circ\text{F}$). Remove the specimens and dry by Procedure C, Drip (see 8.3.3).

8.2.2 Machine Wash—Use specified water level, the selected water temperature for the washing cycle and a rinse temperature of less than 29°C (85°F). If this rinse temperature is not attainable, record available rinse temperature.

8.2.3 Add 66 ± 0.1 g of 1993 AATCC Standard Reference Detergent. In soft water areas this may be reduced to avoid excessive sudsing, but in that case the amount should be stated in the report of test results.

8.2.4 Add test specimens and enough ballast to make a 1.8 ± 0.06 kg (4.00 ± 0.13 lb) load. Set the washer for the selected washing cycle and time (see Tables II and III). Normal or Cotton Sturdy is recommended. For very critical evaluation and in arbitration, limit the number of specimens per washer load to those from one sample.

8.2.5 For specimens to be dried by Procedures A, B or D, allow washing to proceed automatically through the final spin cycle. Remove the test specimens *immediately* after the final spin cycle, separate tangled pieces, taking care to minimize distortion, and dry by Procedure A, B or D (see Tables II and IV).

8.2.6 For specimens to be dried by Procedure C, Drip Dry, remove the specimens from the washer just before the water begins to drain for the final rinse cycle. Remove specimens soaking wet.

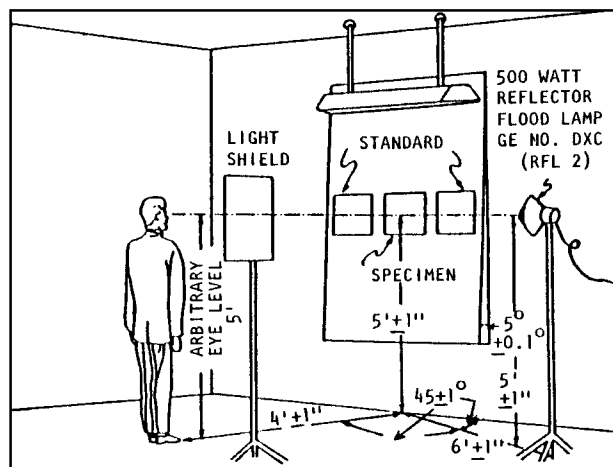

Fig. 2—Lighting and viewing arrangement for crease retention.

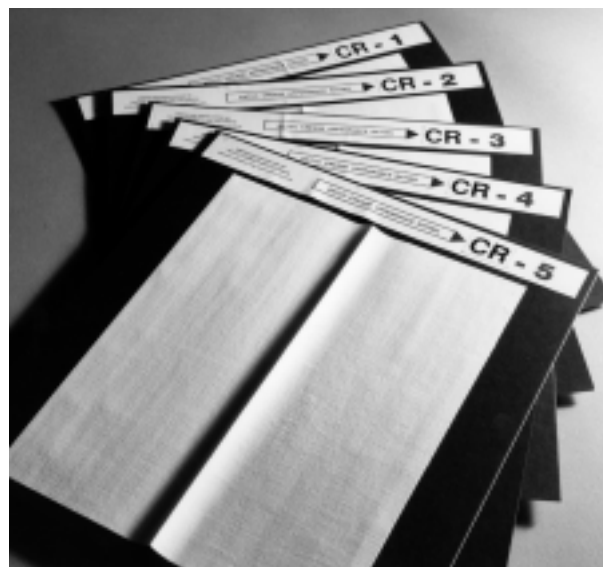

Fig. 3—AATCC crease retention replicas.

Table I—Wash Load Ballast: Finished Fabric Specification

Fiber Content	Wash Load Ballast Type 1 100% Cotton	Wash Load Ballast Type 3 50/50 ± 3% poly/cotton
Yarns	16/1 ring spun	30/2 ring spun
Fabric Construction	52 (± 2) × 48 (± 2)	48 (± 2) × 48 (± 2)
Fabric Weight	155 ± 5 g/m ² (4.55 ± 0.15 oz/yd ²)	155 ± 5 g/m ² (4.55 ± 0.15 oz/yd ²)
Piece Size	92.0 × 92.0 ± 3 cm (36.0 × 36.0 ± 1 in.)	92.0 × 92.0 ± 3 cm (36.0 × 36.0 ± 1 in.)
Piece Weight	130 ± 10 g	130 ± 10 g

Table II—Alternative Washing and Drying Conditions (see 8.1)

Machine Cycle	Wash Temperatures	Drying Procedures
Hand, in pail	(III) 41 ± 3°C (105 ± 5°F)	(A) Tumble:
(1) Normal/Cotton Sturdy	(IV) 49 ± 3°C (120 ± 5°F)	i. Cotton Sturdy
(2) Delicate	(V) 60 ± 3°C (140 ± 5°F)	ii. Delicate
(3) Permanent Press		iii. Permanent Press
		(B) Line
		(C) Drip
		(D) Screen

Table III—Washing Machine Conditions (see 8.1)

	Normal/Cotton Sturdy	Delicate	Permanent Press
Water Level	18 ± 1 gal	18 ± 1 gal	18 ± 1 gal
Agitator Speed	179 ± 2 spm	119 ± 2 spm	179 ± 2 spm
Washing Time	12 min	8 min	10 min
Spin Speed	645 ± 15 rpm	430 ± 15 rpm	430 ± 15 rpm
Final Spin Cycle	6 min	4 min	4 min

Table IV—Dryer Conditions (see 8.1)

	Cotton Sturdy	Delicate	Durable Press
Exhaust Temperature	High 66 ± 5°C (150 ± 10°F)	Low < 60°C (140°F)	High 66 ± 5°C (150 ± 10°F)
Cool Down Time	10 min	10 min	10 min

8.2.7 Washer creases. Specimens may be in a folded or creased conformation after removal from the washer. Such creases present after laundering should be straightened out prior to drying.

8.3 Drying.

8.3.1 (A) Tumble Dry. Place the washed load (test specimens and ballast) in the tumble dryer and set the temperature control to generate the correct exhaust temperatures specified in Table IV. For fibers that are heat sensitive, lower temperatures consistent with producers' recommendations are required, and must be reported. Operate the dryer until the total load is dry. Remove the load immediately after the machine stops. Avoid overdrying. Static cling becomes a problem with overdrying, particularly with lightweight fabrics, because it prevents the specimens from tumbling freely.

8.3.2 (B) Line Dry. Hang each fabric specimen by two corners with the fabric length in the vertical direction. Allow specimens to hang in still air at room temperature until dry.

8.3.3 (C) Drip Dry. Hang each dripping

wet fabric specimen by two corners with the fabric length in the vertical direction. Allow specimens to hang in still air at room temperature until dry.

8.3.4 (D) Screen Dry. Spread each specimen on a horizontal screen or perforated surface, removing wrinkles but not distorting or stretching the specimen. Allow the specimens to dry in still air at room temperature.

8.3.5 Dryer creases. If specimens are folded or creased after any drying cycle but the last, they should be rewet and an attempt should be made to remove the creases prior to additional washing and drying. No attempt to remove wrinkles or creases should be made after the fifth cycle of drying.

8.4 Repeat the selected washing and drying cycles four more times or to an agreed number of cycles.

8.5 Prior to evaluation, precondition and then condition test specimens as directed in ASTM D 1776, Standard Practice for Conditioning and Testing Textiles (see 12.6). Condition the test specimens for a minimum of 4 h in the standard at-

mosphere for textile testing [21 ± 1°C (70 ± 2°F) and 65 ± 2% RH], hanging each specimen from two corners with the fabric length in vertical direction to avoid distortion.

9. Evaluation

9.1 Three trained observers should rate each test specimen independently.

9.2 The overhead fluorescent light and the flood lamp with reflector and light shield, positioned as shown in Fig. 2, should be the only light sources for the viewing board. All other lights in the room should be turned off.

9.3 The observer is to stand directly in front of the specimen 120 ± 3 cm (4 ft ± 1 in.) away from the board. It has been found that normal variations in the height of the observer above and below the arbitrary 1.5 m (5.0 ft) eye level have no significant effect on the grade given.

9.4 Mount the test specimen on the viewing board with the crease in the vertical direction. Place the most similar three-dimensional plastic crease replicas (CR) on each side of the test specimen to facilitate comparative rating. Mount replicas 1, 3 and 5 on the left and 2 and 4 on the right.

9.5 Confine observations to the crease itself and disregard the appearance of the fabric.

9.6 Assign the numerical grade of the replica which most nearly matches the appearance of the crease in the test specimen.

9.7 A crease retention grade of CR-5 is equivalent to the appearance of Standard No. 5, the best level of crease appearance; a crease retention grade of CR-1 is equivalent to that of Standard No. 1, which represents a very poor level of crease appearance.

10. Report

10.1 Crease retention in fabric.

10.1.1 Average the nine observations made on each test fabric (three grades on each of three test specimens). Report the average to the nearest tenth of a grade. This average is the unit of measure of this test method.

10.2 State washing procedure (Arabic number and Roman numeral) and drying procedure (capital letter and subscript) from Table II, as well as type of wash load ballast (Arabic number). Any deviations from stated procedures, such as use of a modified wash cycle, a reduced amount of detergent or a higher than usual load limit, should be explained completely.

10.2.1 For example, crease retention grade CR-3.8 (1-IV-A(i)-3) denotes a crease retention grade of 3.8 for specimens washed using a Normal (Cotton Sturdy) cycle at 49°C (120°F) with Wash load ballast type 3 and tumble dried using the Normal (Cotton Sturdy) cycle.

11. Precision and Bias

11.1 *Interlaboratory Study.* Tests for crease retention were conducted in 1992 with six laboratories evaluating six fabrics under washing condition 1-III-A and drying condition 1-IV-A of Table II. Three raters in each laboratory independently rated the same three specimens from each of the fabrics, yielding nine grades to average for each test result, as required by the method.

11.1.1 The participating laboratories were presumed to be performing the test method under statistical control, without verification.

11.1.2 Committee RA61 directed use of the analysis of variance technique. No correction was made for rating scale discontinuity.

11.1.3 Because variability was quite high in the study, especially residual variance, users of the method are alerted to check for possible sources of variability before initiating any test program.

11.1.4 The analysis has been retained for reference in the Committee RA61 files.

11.2 Precision.

11.2.1 When two or more laboratories wish to compare test results, it is recommended that laboratory level be established between them prior to beginning test comparisons.

11.2.2 Components of Variance are given in Table V, and critical differences for single fabric and for multiple fabric comparisons are given in Tables VI, and VII, respectively.

11.2.3 If comparisons are made between laboratories on a single fabric, critical differences in Table VI are used.

11.2.4 If comparisons are made between laboratories on multiple fabrics, critical differences in Table VII are used.

11.2.5 If two laboratories are shown to be in statistical control and operating at comparable levels, the magnitude of applicable critical differences may be less

Table V—Components of Variance (as variance)

Component	Variance
Laboratory	0.0855
FL Interaction	0.2049
Specimen (FRL)	0.6304

Table VI—Critical Differences for Single Fabric Comparisons (95% probability)

Within Laboratory	Between Laboratory
1.37	1.59

Table VII—Critical Differences for Multiple Fabric Comparisons (95% probability)

Within Laboratory	Between Laboratory
1.37	2.03

than those given in these tables, and may be determined by data from comparison trials between them.

11.3 *Bias.* The value of crease retention can be defined only in terms of a test method. There is no independent method for determining the true value. This test method has no known bias.

12. Notes

12.1 Contact AATCC, P.O. Box 12215, Research Triangle Park NC 27709; tel: 919/549-8141; fax: 919/549-8933; e-mail: orders@aatcc.org, for model number(s) and source(s) of approved washer(s) and dryer(s). Any other washer or dryer which is known to give comparable results may be used. Washing machine conditions given in Table III represent the actual speeds and times available on the current specified model(s). Other washers may vary in one or more of these settings. Dryer machine conditions given in Table IV represent the actual temperatures and cool-down times available on the current specified model(s). Other

dryers may vary in one or more of these settings.

12.2 Available from AATCC, P.O. Box 12215, Research Triangle Park NC 27709; tel: 919/549-8141; fax: 919/549-8933; e-mail: orders@aatcc.org.

12.3 Ballast are available from Testfabrics Inc., P.O. Box 26, 415 Delaware St., W. Pittston PA 18643; tel: 570/603-0432; fax: 570/603-0433; e-mail: testfabric@aol.com; and Textile Innovators Corp., div. of SDL Atlas L.L.C., P.O. Box 8, 101 Forest St., Windsor NC; tel: 252/794-9703; fax: 252/794-9704; e-mail: tic@sdatlas.com. Ballast fabrics should conform to specifications in Table I.

12.4 The use of 8-ft fixtures for viewing laundered specimens is specified in this method. It is recognized, however, that physical limitations in certain laboratories will prevent the use of 8-ft fixtures. In those situations, 4-ft lights may be used.

12.5 If excessive fraying occurs in laundering, specimen edges should be pinked, slashed or stitched as appropriate. If edges of laundered specimens appear distorted, clip as necessary before evaluating.

12.6 ASTM standards are available from ASTM, 100 Barr Harbor Dr., West Conshohocken PA 19428; tel: 610/832-9500; fax: 610/832-9555.

12.7 Like other hand wash procedures, this procedure has inherent limitations; e.g., limited reproducibility of the type of action involved due to the human element.

12.8 The AATCC Technical Center conducted a study to compare the 1993 AATCC Standard Reference Detergent, AATCC Standard Reference Detergent 124 and two different types of fabrics (current and proposed) to be used as ballast, under the following test conditions:

Machine cycle: (1)—Normal/Cotton Sturdy
Washing Temp: (V)—60 ± 3°C (140 ± 5°F)
Drying Procedure: (A)i—Tumble dry, cotton sturdy cycle
Fabrics tested: White Twill (100% cotton)
Beige Twill (100% cotton)
Grey Poplin (100% cotton)
Blue Twill (50/50 poly/cotton)

No significant differences were found in the results using either detergent or ballast load fabrics.

Mercerization in Cotton

Developed in 1958 by AATCC Committee RA66; editorially revised 1974, 1984, 1986, 1988, 1990, 1992; reaffirmed 1974, 1977, 1980, 1989, 1998, 2003; editorially revised and reaffirmed 1985, 1994.

1. Purpose and Scope

1.1 This test method provides a method for the determination of the presence of mercerization in dyed and undyed cotton yarns and fabrics. In addition, the test will give an indication of the completeness of the reaction between the cotton and the mercerization bath.

2. Principle

2.1 Carefully scoured specimens of the cotton to be tested and unmercerized cotton are immersed in separate baths of barium hydroxide solution for a definite time period. Aliquot portions of each soaking bath and of fresh barium hydroxide solution are then titrated with hydrochloric acid.

2.2 The ratio of the amount of barium hydroxide absorbed by the mercerized specimen to that absorbed by the unmercerized specimen multiplied by 100 gives the barium activity number.

3. Terminology

3.1 **mercerization, n.**—a process for irreversibly altering the physical characteristics and appearance of natural cellulose fibers by swelling in strong alkali.

4. Safety Precautions

NOTE: These safety precautions are for information purposes only. The precautions are ancillary to the testing procedures and are not intended to be all inclusive. It is the user's responsibility to use safe and proper techniques in handling materials in this test method. Manufacturers MUST be consulted for specific details such as material safety data sheets and other manufacturer's recommendations. All OSHA standards and rules must also be consulted and followed.

4.1 Good laboratory practices should be followed. Wear safety glasses in all laboratory areas.

4.2 All chemicals should be handled with care.

4.3 Use chemical goggles or face shield, impervious gloves and an impervious apron during dispensing and mix-

ing of barium hydroxide, sodium carbonate and hydrochloric acid. Concentrated acids should be handled only in an adequately ventilated laboratory hood. CAUTION: Always add acid to water.

4.4 Petroleum solvent can be a combustible or flammable liquid, depending on which solvent is used, and presents a hazard. Ethanol and methanol are flammable liquids. Flammable liquids should be stored in the laboratory only in small containers away from heat, open flame and sparks. These chemicals should not be used near an open flame.

4.4.1 Carry out reflux procedure in a well ventilated hood with an electrical heating mantle or a water bath as the heat source.

4.4.2 Use chemical goggles or face shield, impervious gloves and an impervious apron when handling organic solvents.

4.5 An eyewash/safety shower should be located nearby and an organic vapor respirator and a self-contained breathing apparatus should be readily available for emergency use.

4.6 Exposure to chemicals used in this procedure must be controlled at or below levels set by governmental authorities [e.g., Occupational Safety and Health Administration's (OSHA) permissible exposure limits (PEL) as found in 29 CFR 1910.1000 of January 1, 1989]. In addition, the American Conference of Governmental Industrial Hygienists (ACGIH) Threshold Limit Values (TLVs) comprised of time weighted averages (TLV-TWA), short term exposure limits (TLV-STEL) and ceiling limits (TLV-C) are recommended as a general guide for air contaminant exposure which should be met (see 13.7).

5. Limitations

5.1 The test cannot be used satisfactorily if durable finishes or fibers other than cotton are present.

6. Apparatus

6.1 Burette (preferably automatic) (see 13.4).

6.2 Flask, Erlenmeyer, with reflux tube.

6.3 Flasks, glass-stoppered, 250 mL.

6.4 Flasks, Erlenmeyer, 125 mL.

6.5 Bottles, storage, 250-500 mL.

6.6 Beaker, 1500 mL.

6.7 Pipette, 10 mL.

6.8 Drying oven.

7. Reagents and Materials

7.1 Hydrochloric acid (HCl) standardized approx. 0.1*N*.

7.2 Barium hydroxide reagent [Ba(OH)₂] approximately 0.25*N* (see 13.1).

7.3 Phenolphthalein.

7.4 Petroleum solvent [BP 30-60°C (86-140°F)].

7.5 Alcohol (95% ethanol or anhydrous methanol).

7.6 Enzyme, starch-solubilizing.

7.7 Soap, neutral, granular (see 13.2).

7.8 Water, distilled.

7.9 Cotton yarn, unmercerized for reference (standard cotton) (see 13.3).

8. Test Specimens

8.1 A minimum of 5 g of each sample and of the unmercerized standards are scoured as directed after which a 2 g specimen of each scoured sample is weighed and placed in clean, dry glass-stoppered flasks.

9. Procedure

9.1 Scouring. The purpose of the scouring operation is to remove all extraneous matter, leaving the cotton cellulose in as pure a form as possible and without changing it chemically.

9.1.1 The samples to be tested (at least 5 g each), together with the standard unmercerized cotton, are refluxed together successively for 1 h with petroleum solvent [boiling point 30-60°C (86-140°F)], 1 h with alcohol (95% USP ethanol, No. 30 specially denatured alcohol, 95% or anhydrous methanol may be used), and for 1 h with distilled water (see 13.4).

9.1.2 Following these three extractions, starches are removed as follows:

9.1.3 Cover the sample with distilled water containing 3% of a commercial starch-solubilizing malt enzyme solution and heat to 60 ± 5°C (140 ± 9°F). Maintain the solution at this temperature for a period of 1 h. Pour off the enzyme solution, rinse and then scour as follows.

9.1.4 Boil the samples together for 1 h in 1 L of water containing 10 g of a neutral soap and 2 g of soda ash. Wash repeatedly in warm water until free from soap and alkali, i.e., until neutral to phenolphthalein, squeeze and dry. The samples and the standard unmercerized cotton are dried in an oven at 100°C (212°F) until thoroughly dry. The samples are then allowed to come to room conditions. Each sample should then be cut into

small pieces [approximately 3 mm (0.125 in.) square] for subsequent weighing.

9.2 Testing. Prepare and test duplicate specimens from each sample. Weigh 2 g of each scoured sample and of the scoured standard cotton into dry 250-mL flasks equipped with stoppers. (Ground glass stoppers are recommended.) Add 30 mL 0.25*N* barium hydroxide (see 13.5) to each flask containing a test specimen and to two empty flasks for blank determinations. Stopper each flask immediately upon addition of the barium hydroxide and store them for at least 2 h in a water bath at 20–25°C (68–77°F) (room temperature). Shake the flasks at frequent intervals. After 2 h, transfer 10 mL of solution (see 13.6) from each container, including the blanks and titrate with 0.1*N* hydrochloric acid, using phenolphthalein as an indicator.

10. Calculations

10.1 Using the titration figures, determine the ratio of barium hydroxide absorbed by a mercerized specimen to that absorbed by the unmercerized standard. Multiply this ratio by 100 to obtain the barium activity number.

Example: 10 mL of barium hydroxide solution (blank) required 24.30 mL of 0.1*N* HCl; 10 mL of barium hydroxide from an unknown sample of cotton required 19.58 mL of 0.1*N* HCl; 10 mL of barium hydroxide from unmercerized cotton (standard) required 21.20 mL of 0.1*N* HCl. Therefore the barium number of the unknown sample is:

$$\frac{24.30 - 19.58}{24.30 - 21.20} \times 100 = 152$$

10.2 Barium numbers should be run in duplicate and should be reported separately. Duplicate runs should not be off by more than four units. The titrations should be within 0.1 mL for check results. Skilled operators can estimate to within 0.05 mL. A difference of more than four units between duplicate runs indicates inaccuracy in running the test (see Table I).

11. Interpretation

11.1 A barium activity number in the range of 100–105 indicates no merceriza-

Table I—Barium Numbers: Interlaboratory Tests on Mercerized Fabrics

Cloth	Lab A	Lab B	Lab C ¹	Lab C ²	Lab C ³
80 × 80—35° Tw	118	118	117	120	114
80 × 80—55° Tw	130	131	128	132	125
108 × 58—55° Tw	141	145	143	143	140
136 × 64—55° Tw	122	123	123	122	120
88 × 50—55° Tw	139	140	136	140	133

¹ Fabrics scoured by Lab C, unmercerized 80 × 80 as standard.

² Fabrics scoured by Lab A, unmercerized 80 × 80 as standard.

³ Fabrics scoured by Lab C, 40/2 combed mercerized yarn as standard.

tion. A barium activity number above 150 indicates substantially complete reaction between the cotton and the mercerizing bath. Intermediate numbers indicate either incomplete reaction or use of a weak mercerizing bath.

12. Precision and Bias

12.1 *Precision*. Precision for this test method has not been established. Until a precision statement is generated for this test method, use standard statistical techniques in making any comparisons of test results for either *within-laboratory* or *between-laboratory* averages.

12.2 *Bias*. Mercerization in cotton can be defined only in terms of a test method. There is no independent method for determining the true value. As a means of estimating this property, the method has no known bias.

13. Notes

13.1 The barium hydroxide reagent is prepared by shaking distilled water with slightly more than the calculated quantity of barium hydroxide, allowing it to stand overnight in a stoppered bottle, and then siphoning the clear solution into a clean storage bottle.

13.2 Available from AATCC, P.O. Box 12215, Research Triangle Park NC 27709; tel: 919/549-8141; fax: 919/549-8933; e-mail: orders@aatcc.org.

13.3 Unmercerized standard cotton skeins (40/2 ply) as used for the Draves Wetting Tests are particularly satisfactory. They may be obtained from Testfabrics Inc., P.O. Box 26, 415 Delaware St., W. Pittston PA 18643; tel: 570/603-0432; fax: 570/603-0433; e-mail: testfabric@aol.com.

13.4 If it is known that all samples that test do not contain finish or starch, then the scouring procedure may begin with the soap-and-

soda ash treatment. If one sample requires solvent extraction and the enzyme treatment, then all samples including the standard cotton must be treated together with the complete scouring procedure to insure the same final state for the whole set of samples.

13.5 An automatic burette is most convenient for the addition of the barium hydroxide solution to the specimens. The air outlet must be equipped with an absorption tube containing soda lime to remove carbon dioxide. The latter must not be allowed to enter any burette that might be used, because formation of barium carbonate not only affects the concentration of the reagent but forms a film which interferes with burette readings. A cork is fitted to the bottom of the burette in such a manner that the 250 mL Erlenmeyer flasks containing the specimens under test are locked into place without exposure to air during the addition of barium hydroxide. The barium hydroxide solution should cover the specimens, tilting the flasks if necessary to accomplish this end.

13.6 For the removal of 10 mL of barium hydroxide when equilibrium has been reached, a 10 mL pipette is used. The same pipette, burette, etc., should be used for the whole set of determinations and the same technique for emptying or filling pipettes and burettes should be used on each determination. The hydrochloric acid burette is also equipped with a cork to which the 125 mL flask can be attached during the titration of the 10 mL aliquot portions of barium hydroxide, thereby eliminating titration errors resulting from carbon dioxide absorption by the alkaline solution. In removing the 10 mL aliquot portion of barium hydroxide from flasks containing specimens, the operator should use the end of his pipette to push the cotton against the wall of the flask and to express the excess liquor. In this way, a larger amount of the solution will be available for drawing up into the pipette.

13.7 Available from Publications Office, ACGIH, Kemper Woods Center, 1330 Kemper Meadow Dr., Cincinnati OH 45240; tel: 513/742-2020.

Chlorine, Retained, Tensile Loss: Single Sample Method

Developed in 1958 by AATCC Committee RR35; reaffirmed 1962, 1967, 1971, 1977, 1980, 1989, 1999; editorially revised 1974, 1988, 1992; editorially revised and reaffirmed 1985, 1994, 2004.

1. Purpose and Scope

1.1 This is an accelerated test method to determine the potential damage caused by retained chlorine. It has been designed for use on cotton and rayon fabrics, but may be used on any fabric or finish that is not damaged by heat alone (see 11.1).

2. Principle

2.1 The fabrics are treated in sodium hypochlorite solution, rinsed, dried and pressed between hot metal plates. The damaging action of the retained chlorine is calculated from the difference in tensile strength before and after pressing.

3. Terminology

3.1 **retained chlorine, n.**—*in textiles bleached with chlorine-type bleaches*, available chlorine which remains in the material after washing and drying.

4. Safety Precautions

NOTE: These safety precautions are for information purposes only. The precautions are ancillary to the testing procedures and are not intended to be all inclusive. It is the user's responsibility to use safe and proper techniques in handling materials in this test method. Manufacturers MUST be consulted for specific details such as material safety data sheets and other manufacturer's recommendations. All OSHA standards and rules must also be consulted and followed.

4.1 Good laboratory practice should be followed. Wear safety glasses in all laboratory areas.

4.2 Manufacturer's safety recommendations should be followed when operating laboratory testing equipment.

4.3 All chemicals should be handled with care. Use chemical goggles or face shield, impervious gloves and an impervious apron when handling sodium carbonate and sodium hypochlorite bleach solutions; these are corrosive chemicals.

4.4 An eyewash/safety shower should be located nearby and a self-contained breathing apparatus should be readily available for emergency use.

4.5 Exposure to chemicals used in this procedure must be controlled at or below levels set by governmental authorities (e.g., Occupational Safety and Health Administration's [OSHA] permissible exposure limits [PEL] as found in 29 CFR 1910.1000 of January 1, 1989). In addition, the American Conference of Governmental Industrial Hygienists (ACGIH) Threshold Limit Values (TLVs) comprised of time weighted averages (TLV-TWA), short term exposure limits (TLV-STEL) and ceiling limits (TLV-C) are recommended as a general guide for air contaminant exposure which should be met (see 11.7).

5. Apparatus and Reagents

5.1 Beakers, 800 mL.

5.2 pH meter (see 11.2).

5.3 Constant temperature bath (or suitable alternative means of controlling temperatures).

5.4 Wringer, laboratory or household type.

5.5 Scorch tester (see Fig. 1 and 11.3).

5.6 Tensile-strength tester (see 11.4).

5.7 Sodium hypochlorite stock solution; e.g., Clorox, having an available chlorine content of approximately 5.0%.

5.8 Water, distilled.

6. Preparation of Sample

6.1 Normally, only warpwise specimens are tested. Cut the sample approximately 35.6 cm (14 in.) in the warpwise direction and 20.3 cm (8 in.) in the fill-

ingwise direction (if testing filling specimens, reverse these figures).

7. Preparation of Solutions

7.1 Prewetting and Rinse Solutions. Determine the pH of the distilled water; if outside the range of 6-7, report the actual pH with the final results of test (see 11.5).

7.2 Chlorination Solution. Prepare a chlorination solution containing 0.25% available chlorine at a pH of 9.5 ± 0.1 as follows:

7.2.1 Determine the percent available chlorine (Cl) of the sodium hypochlorite stock solution; e.g., Clorox (see 11.6).

7.2.2 Calculate the number of grams (g) of stock solution required to make one liter of a 0.25% available chlorine solution as follows:

$$g = (1000 \times 0.25)/Cl$$

where:

g = grams of stock solution required.

Cl = % available chlorine determined.

7.2.3 To 900 mL of distilled water add the calculated grams (g) of stock solution required. Adjust the pH to 9.5 ± 0.1 by the addition of either sodium bicarbonate to lower the pH or sodium carbonate to raise it. Finally, add distilled water to make 1 L and recheck the pH.

8. Procedure

8.1 Because many factors, such as pH, concentration and time, significantly influence the amount of damage caused by retained chlorine, it is *important* to fol-

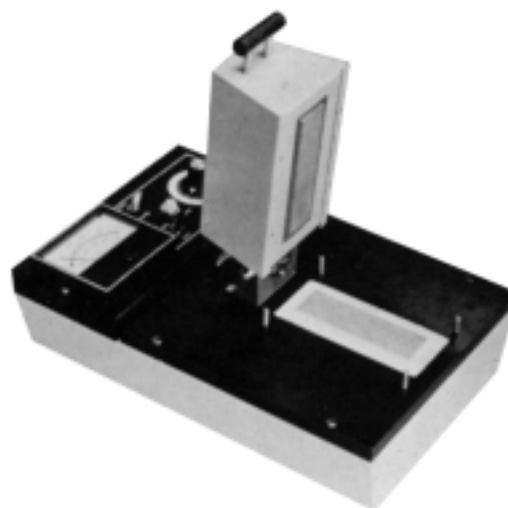

Fig. 1—Scorch tester.

low closely the conditions of the test. Should any deviations be necessary, they should be reported in order that the test results may be evaluated accordingly. As a means of checking the test procedure, it is well to run, at the same time, a cotton fabric whose chlorine-retentive properties have been determined previously.

8.2 Chlorination Step.

8.2.1 Prewetting Bath. Measure into an 800-mL beaker a volume of distilled water equal to 50 times the dry weight of the fabric sample. Immerse the sample for 3 min at $71 \pm 3^\circ\text{C}$ ($160 \pm 5^\circ\text{F}$), stirring frequently. Remove sample from bath, allow to drain and cool at room temperature.

8.2.2 Chlorination Bath. Transfer the sample to an 800-mL beaker containing the chlorination solution (equal to 50 times the dry weight of the fabric) which is maintained at a temperature of $25 \pm 1^\circ\text{C}$ ($77 \pm 2^\circ\text{F}$). Agitate the sample frequently and gently with a glass stirring rod during the 15 min chlorination period. At the end of 15 min, remove sample, allow to drain momentarily, and pass through a wringer, to remove as much solution as possible using care to keep the sample flat and free from wrinkles. Rinse equipment free of chlorination solution with distilled water, to avoid contamination of specimens during the subsequent rinsing procedure.

8.2.3 Rinsing. Immerse the sample in a 800-mL beaker containing distilled water (equal to 50 times the weight of the sample) at a temperature of $21\text{--}32^\circ\text{C}$ ($70\text{--}90^\circ\text{F}$) for 2 min, agitating the sample gently and continually. Remove the sample from the bath, allow to drain momentarily, and then pass through a wringer, as before, taking all precautions mentioned previously.

8.2.4 Repeat this rinsing procedure five more times, making a total of six rinses. For greater precision, rinse all samples separately, to avoid danger of contamination.

8.2.5 Drying. Samples are to be *air-dried*. Hang on a line or dry flat on a non-corrosive rack, away from heat, until just dry (do *not* press!). Transfer at once to a conditioned atmosphere at $65 \pm 2\%$ RH and $21 \pm 1^\circ\text{C}$ ($70 \pm 2^\circ\text{F}$) and allow to remain through the scorching step and tensile strength testing.

8.3 Scorching Step.

8.3.1 Prepare warp specimens by carefully cutting five strips approximately 35.6×3.2 cm (14.0×1.25 in.). Ravel the 3.2 cm (1.25 in.) strips to exactly 2.54 cm (1.0 in.) following ASTM D 5035, Test for Breaking Force and Elongation of Textile Fabrics (Strip Test), in preparing specimens. Then trim the 35.6 cm (14.0 in.) length to 30.5 cm (12.0 in.). From this set of five 2.54×30.5 cm (1.0×12.0 in.) strips, make two sets (from the same set of warp yarns) of 2.54×15.2 cm (1.0

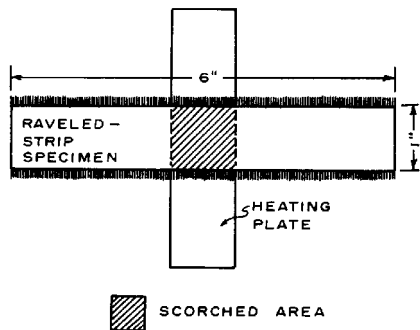

Fig. 2—Specimen on heating plate.

$\times 6.0$ in.) raveled strip specimens by cutting the strips in two. These sets should be kept separate; one set is to be scorched, the other used as a control. The total conditioning time should be not less than 4 nor more than 24 h.

8.3.2 Prepare Scorch tester in advance so that the heating plates of the instrument maintain a temperature of $185 \pm 1^\circ\text{C}$ ($365 \pm 2^\circ\text{F}$). If necessary, to avoid air currents, enclose instrument in a cabinet. Make sure the two heating plates are clean and in good adjustment (uniformly in contact at all points). Scorch each strip of one set separately (one at a time) by placing the 2.54×15.2 cm (1.0×6.0 in.) specimen in the Scorch tester with the long direction of the raveled strip perpendicular to the long direction of the heating plates so that it is scorched across the center of the raveled strip (see Figs. 1 and 2). Scorch the strips for 30 s. Check reading of the thermometers frequently during use. Condition the specimens again; this time conditioning at least 16 h before making tensile strength measurements.

8.4 Tensile Strength.

8.4.1 Make tensile strength tests on the unscorched and scorched specimens and record the individual values. From those, calculate the average tensile strength for each set.

9. Calculation of Damage Caused by Retained Chlorine

9.1 Use the formula as follows:

$$(T_c - T_{cs})/T_c \times 100 =$$

% loss in tensile strength due to damage caused by retained chlorine.

where:

T_c = average tensile strength of chlorinated specimens, unscorched, and

T_{cs} = average tensile strength of chlorinated specimens, scorched.

10. Precision and Bias

10.1 *Precision.* Precision for this test

method has not been established. Until a precision statement is generated for this test method, use standard statistical techniques in making any comparisons of test results for either *within-laboratory* or *between-laboratory* averages.

10.2 Bias. The retained chlorine as determined by tensile loss-single sample method can be defined only in terms of a test method. There is no independent method for determining the true value. As a means of estimating this property, the method has no known bias.

11. Notes

11.1 Where it is suspected that either fabric or finish is susceptible to damage on heating, this susceptibility can be determined by running a distilled water control. That is, the fabric is run through the entire procedure, but using distilled water in place of the hypochlorite solution. The loss in strength due to heat alone is calculated by the equation:

$$(T_w - T_{ws})/T_w \times 100 =$$

% tensile strength loss due to scorching alone.

where:

T_w = average tensile strength of the water-treated specimens, unscorched, and

T_{ws} = average tensile strength of the water-treated specimens, scorched.

If this loss is appreciable, there is some question as to whether the chlorine damage test is applicable.

It is usually not necessary to determine the effect of wet chlorination on the fabric, as this factor is canceled out in the calculation for chlorine damage. However, where it is desirable to determine the effect of the wet chlorination step, this may be calculated as follows:

$$(T_w - T_{wc})/T_w \times 100 =$$

% tensile strength loss due to wet chlorination.

where:

T_w = average tensile strength of the water-treated specimens, unscorched (handled as above), and

T_{wc} = average tensile strength of the original fabric chlorinated and unscorched.

11.2 Any standard laboratory pH meter having suitable provision for high pH readings. Colorimetric methods cannot be used with NaOCl.

11.3 A pair of electrically heated hot plates whose temperature is accurately controlled and which can be adjusted to provide a pressure on the specimen of 8.8 g/cm^2 ; e.g., Scorch tester available from SDL Atlas L.L.C., 1813A Associate Lane, Charlotte NC 28217; tel: 704/329-0911; fax: 704/329-0914; e-mail: info@sdlatlas.com. In order to obtain the specified pressure of 8.8 g/cm^2 the four spring loaded pins must contact the upper housing so that they counterbalance the proper proportion of the weight of the upper housing to provide the specified pressure on the test specimen.

Other similar devices providing identical test conditions and results may be used.

11.4 Example: A Scott tensile strength tester, having a suitable breaking-strength range (see ASTM D 76 and ASTM D 5035).

11.5 There is reason to believe that the pH of the prewetting and rinsing solutions may influence the results obtained in this test method. However, in view of the widespread variation of pH in commercial practice, the

Committee on Damage Caused by Retained Chlorine is not as yet prepared to fix a specific value for the test procedure. Experimentation is being conducted on this point.

11.6 For determining the percent available chlorine, pipette a 1.00-mL portion of Clorox into an Erlenmeyer flask and dilute to 100 mL with distilled water. Add 20 mL of 6*N* H₂SO₄ and 6 mL of 12% KI. Titrate with 0.1*N* sodium thiosulfate solution.

Calculation:

% available Chlorine =

$$\frac{\text{mL Na thiosulfate} \times 0.1N \times 0.0355}{1 \text{ mL} \times \text{sp gr NaOCl soln}} \times 100$$

11.7 Available from Publications Office, ACGIH, Kemper Woods Center, 1330 Kemper Meadow Dr., Cincinnati OH 45240; tel: 513/742-2020.

Abrasion Resistance of Fabrics: Accelerotor Method

Developed in 1959 by AATCC Committee RA29; revised 1966, 1984, 2005; re-affirmed 1974, 1977, 1989; editorially revised 1978, 1985, 1986, 1995; editorially revised and reaffirmed 1994, 1999, 2004.

1. Purpose and Scope

1.1 This test method is intended for evaluating the resistance of fabrics and other flexible materials to abrasion (see 14.1).

2. Principle

2.1 An unfettered fabric specimen is driven by an impeller (rotor) along a zig-zag course in a generally circular orbit within a cylindrical chamber, so that it repeatedly impinges on the walls and abradant liner of the chamber while at the same time being continually subjected to extremely rapid, high velocity impacts. The specimen is subjected to flexing, rubbing, shock, compression, stretching and other mechanical forces during the test. Abrasion is produced throughout the specimen by rubbing of yarn against yarn, fiber against fiber, surface against surface and surface against abradant.

2.2 Evaluation is made on the basis of weight loss of the specimen or grab strength loss of the (woven) specimen when broken at an abraded fold line. Generally, flat woven fabrics may be evaluated by either method. Tufted and other fabrics with raised surfaces, and knit fabrics, are evaluated by the weight loss method.

2.3 Changes in other fabric characteristics may also be useful for evaluating abrasion resistance with the Accelerotor (see 14.13).

3. Terminology

3.1 **abrasion, n.**—the wearing away of any part of a material by rubbing against another surface.

4. Safety Precautions

NOTE: These safety precautions are for information purposes only. The precautions are ancillary to the testing procedures and are not intended to be all inclusive. It is the user's responsibility to use safe and proper techniques in handling materials in this test method. Manufacturers MUST be consulted for specific details such as material safety data sheets and other manufacturer's recommenda-

tions. All OSHA standards and rules must also be consulted and followed.

4.1 Good laboratory practices should be followed. Wear safety glasses in all laboratory areas.

4.2 The door of the Accelerotor must be kept closed whenever the motor is running. Manufacturer's safety recommendations should be followed when operating laboratory testing equipment.

4.3 A face mask is recommended for operators who work regularly with the Accelerotor to guard against inhalation of fiber dust.

5. Uses and Limitations

5.1 The results obtained by this method are affected by duration; the size, shape and angular velocity of the rotor; and by the type of liner used. These effects are interrelated, and testing conditions may be varied to produce different degrees of abrasion in a test specimen. For example, it may require only 2 or 3 min at 209.44 rad/s (2000 rpm) with the standard offset rotor to produce a reasonable degree of abrasion in a delicate or fragile fabric, while a heavier or more durable fabric may require 6 min at 314.16 rad/s (3000 rpm).

5.2 When fabrics curl or, for other reasons, do not move about freely in the test chamber, testing should be discontinued.

5.3 The results of this test should not be equated with service life.

6. Apparatus and Materials

6.1 Accelerotor (Fig. 1; see 14.2) equipped with the following parts:

6.1.1 Rotor, offset (elongated S-shape), 114 mm (4.5 in.) (Fig. 2) (see 14.3 for descriptions of alternate rotors).

6.1.2 Collar insert, plastic, lined with 3.2 mm (0.125 in.) polyurethane foam.



Fig. 1—Accelerotor fitted with abrasive liner over foam rubber cushion and with 114 mm (4.5 in.) S-shape rotor.



Fig. 2—Elongated S-shape rotor.

6.2 Liner, fine abrasive, 500J grit aluminum oxide cloth (see 14.2; an alternate abrasive liner is described in 14.4).

6.3 Neon lamp or other stroboscopic device (see 14.2).

6.4 Timer, automatic, accurate to ± 1 s.

6.5 White glue, such as Elmers Glue-All, in squeeze bottle.

6.6 Pinking shears and marking templates, or cutting dies (see 14.9).

6.7 Brush, nylon, for cleaning Accelerotor chamber (see 14.2) or small portable vacuum cleaner for chamber and specimens.

6.8 Thread, size E, Type I, Class 1 or 2, Fed. Spec. V-T-295 (see 14.5).

6.9 Cotton fabric, 80 \times 80 print cloth (carded yarns) 1.2 m (46 in.) wide, about 8 m/kg (4 yd/lb), bleached and desized, free from blueing, optical bleach or finishing materials (see 14.6).

6.10 Analytical balance accurate to ± 0.001 g.

7. Test Specimens

7.1 In the absence of applicable specifications, take a minimum of three specimens from each sample to be tested not nearer the selvage than one-tenth the width of the fabric or 64 mm (2.5 in.). Select specimens that are representative of the whole sample to be tested.

7.2 Size of Specimens.

7.2.1 Method A (Evaluation by weight loss)—Cut specimens of heavier or bulkier fabrics smaller than those of lighter fabrics to minimize variations in impact produced when the specimens hit the chamber wall or abradant liner. Table I is a guide to the relationship between fabric weight, in grams per square meter (ounces per square yard), and specimen size. Specimens may be taken with the edges parallel to the warp and filling (courses and wales) or on the bias.

7.2.2 Method B (Evaluation by strength loss)—The specimen size is 100 \times 150 mm (4 \times 6 in.) with the greater dimension in the direction of the yarns to be broken. Take specimens with their edges parallel to the warp and filling yarns.

Table I—Selection of Specimen Size

Weight Range of Fabrics ^a	Size of Specimens ^b
300-400 (9-12)	95 (3.75)
200-300 (6-9)	115 (4.5)
100-200 (3-6)	135 (5.25)
less than 100 (3)	150 (6)

^a Grams per square meter (ounces per square yard)

^b Millimeters (inches) square

7.3 Specimen Preparation.

7.3.1 Method A—Cut a specimen with pinking shears or die (see 14.9). If woven fabric is die-cut parallel to yarns, ravel 3.2 mm (0.125 in.) along each edge. Place the specimen on plastic sheet (to protect bench top) and apply a 3.2 mm (0.125 in.) strip of adhesive to each cut or raveled edge (Fig. 3) (see 4.3 and 14.10). Allow the adhesive to dry at room temperature.

7.3.2 Method B—Cut specimens 100 × 300 mm (4 × 12 in.) (twice the length required for the grab breaking strength test). Number each specimen at both ends, and then cut in half. Use one half for a control to determine the original grab breaking strength, and the other to determine grab breaking strength after abrading. Apply adhesive to the edges of the specimens to be abraded as in Method A. Then fold each specimen perpendicular to the long dimension and 50 mm (2 in.) from one end, making it into a 100 × 100 mm (4 × 4 in.) square. Attach the 50 × 100 mm (2 × 4 in.) flap with a seam 6 mm (0.25 in.) from its edge to the body of the specimen (Fig. 4). Use 4 stitches to

the centimeter (11 stitches per inch) (see 14.5).

8. Accelerator

8.1 Adjustment of Tachometer.

8.1.1 Rotor—Select and install appropriate rotor. The 114 mm (4.5 in.) offset rotor is standard) (see 14.3).

8.1.2 Neon Lamp—To check the accuracy of the tachometer, the neon lamp is used as a simple stroboscope to view the spinning rotor. With the test chamber door closed and the neon bulb held close to the window of the door, the rotor gives distinct patterns at several useful speeds. With some practice, the following patterns will be recognized: If the neon lamp is being operated on 60 Hz AC, at 188.50 rad/s (1800 rpm) the rotor appears as a stationary distinct two-bladed figure. At 377 rad/s (3600 rpm) the hub of the rotor appears as a stationary blur, with two slight lobes apparent on the sides of the hub. If the neon lamp is operated on 50 Hz AC, as in many European countries, the above described test patterns will appear at 157.08 and 314.16 rad/s (1500 and 3000 rpm). If the tachometer does not read the appropriate speed, turn the small screw on the dial face to correct it.

8.1.3 Stroboscope—Set the stroboscope dial at 314.16 rad/s (3000 rpm). Close the Accelerator door, turn the unit on, and bring the speed of the rotor to a point at which it appears as a stationary, two-bladed figure. If the tachometer does not read 314.16 rad/s (3000 rpm), turn the small screw on its dial face to correct it.

8.2 Liners (see 14.4).

8.2.1 Installation of Liners—Place

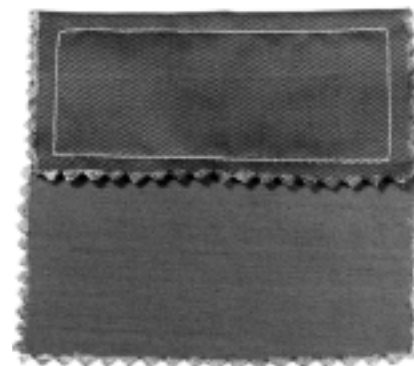

Fig. 4—Specimen prepared for testing by Method B.

liner into collar insert and, with the fingers, work liner around the insert wall until it fits snugly and smoothly without any crease.

8.2.2 Break-in of Fresh Liner—Insert the prepared collar insert into the Accelerator equipped with the selected rotor. Break in the abrasive liner by running two successive 114 mm (4.5 in.) square specimens of 80 × 80 finish-free cotton print cloth (see 6.9), edged with adhesive. Close the door, start the Accelerator, and maintain rotor speed at 314.16 rad/s (3000 rpm) for 6 min. Replace with the second specimen and continue until total running time is 12 min. Stop the Accelerator and remove the specimen. Brush or vacuum the abrasive liner to remove detritus.

8.2.3 Reversal of Line—For greater reproducibility, it is recommended that after six test specimens have been run, the collar assembly be removed from the Accelerator and reversed so that the rim which was next to the door is placed at the back of the chamber.

8.2.4 Change of Liner—It is recommended that an abrasive liner be discarded after 12 specimens have been run. If the liner has not been subjected to severe duty, it may be used for more than 12 tests. To check the condition of a liner, determine the weight loss of finish-free 80 × 80 cotton print cloth (see 6.9) at the beginning of a series of tests and after intervals of six test specimen runs. The life of some abrasive liners can be extended to a considerable degree by laying them on a flat surface and scrubbing them with the nylon brush and soapy water to remove finishes or other materials deposited on them by some fabrics. After washing, the liners should be thoroughly rinsed with water and dried before their effectiveness is rechecked.

9. Conditioning

9.1 Let prepared specimens reach approximate moisture equilibrium in the standard atmosphere for preconditioning and then condition them in the standard

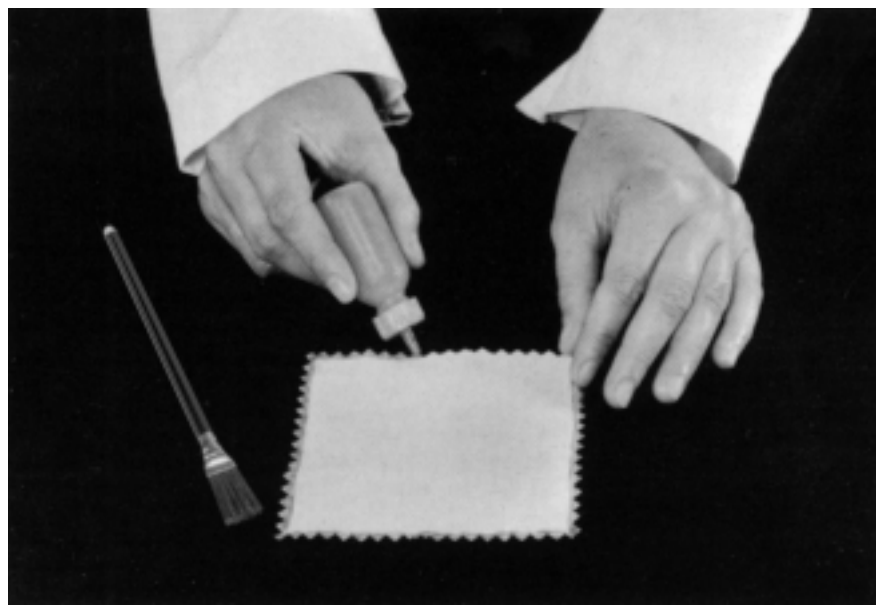

Fig. 3—Application of adhesive (see 6.5) to pinked edges of specimen from plastic squeeze bottle.

atmosphere for testing textiles, as specified in ASTM D 1776, Standard Practice for Conditioning and Testing Textiles.

10. Testing Procedures

10.1 Method A—Weight Loss

10.1.1 Weigh the conditioned specimen (see 9) on an analytical balance (see 6.10).

10.1.2 Set up Accelerotor with the elongated, S-shaped, offset, 114 mm (4.5 in.) long rotor, and a fine abrasion, 500J grit aluminum oxide cloth (see 14.3, 14.4 and 14.8).

10.1.3 Crumple the test specimen and place it in the chamber.

10.1.4 Close the door (see 4), start the Accelerotor and timer, and maintain accurately, ± 10.48 rad/s (100 rpm), at the selected speed for the desired time. The operating speed usually is maintained at 314.16 ± 10.48 rad/s (3000 ± 100 rpm) for a period of time sufficient to abrade the specimen substantially without tearing it; e.g., 2-6 min (see 14.8).

10.1.5 Stop the Accelerotor at the end of the time (± 2 s) and remove the test specimen.

10.1.6 Brush or vacuum the liner to remove detritus.

10.1.7 Shake or vacuum the specimen free of detritus.

10.1.8 Condition the tested specimen (see 9.1).

10.1.9 Reweigh the specimen on an analytical balance to ± 0.001 g.

10.2 Method B—Strength Loss

10.2.1 Perform Steps 10.1.2 through 10.1.7.

10.2.2 Remove stitching thread to restore specimen to 100×150 mm (4×6 in.) dimensions.

10.2.3 Condition specimen as directed in 9.1.

10.2.4 Determine breaking strength by the Grab Method given in ASTM D 5034, Test for Breaking Force and Elongation of Textile Fabrics (Grab Test), placing the abraded fold of the test specimen parallel to and equidistant from the jaws of the tensile tester (see 14.7). The specimen must break along the fold for a valid test.

10.2.5 Determine breaking strength on conditioned (see 9.1) original (unabraded) (see 7.3.2) specimen.

11. Calculations and Evaluation

11.1 Method A—Weight Loss. Calculate the percent loss in weight for each specimen to $\pm 0.1\%$.

11.2 Method B—Strength Loss. Calculate the percent strength loss for each pair (see 7.3.2) of specimens.

11.3 Calculate the average for each method.

12. Report

12.1 Method A—Report the average percent weight loss for the three test specimens.

12.2 Method B—Report the average percent strength loss for the three test specimens.

12.3 The report must state the exact conditions employed; i.e., rotor speed, time, size and type of rotor and type of liner. For Method A also state the specimen size used.

13. Precision and Bias

13.1 *Precision*. Precision for this test method has not been established. Until a precision statement is generated for this test method, use standard statistical techniques in making any comparisons of test results for either *within-laboratory* or *between-laboratory* averages.

13.2 *Bias*. The abrasion resistance of fabrics (Accelerotor method) can be defined only in terms of a test method. There is no independent method for determining the true value. As a means of estimating this property, the method has no known bias.

14. Notes

14.1 For additional information see: T. F. Cooke, Abrasion Testing with the Accelerotor: Reproducibility in Interlaboratory Tests, *American Dyestuff Reporter*, Vol. 47, No. 20, 1958, pp. 679-83; H. W. Stiegler, H. E. Glidden, G. J. Mandikos and G. R. Thompson, "The Accelerotor for Abrasion Testing and Other Purposes," *American Dyestuff Reporter*,

Vol. 45, No. 19, 1956, pp. 685-700.

14.2 Available from SDL Atlas L.L.C., 1813A Associate Lane, Charlotte NC 28217; tel: 704/329-0911; fax: 704/329-0914; e-mail: info@sdlatlas.com.

14.3 For special applications, pitched-blade rotors 108 mm (4.25 in.), 114 mm (4.50 in.) and 121 mm (4.75 in.) long and a 108 mm (4.25 in.) offset S-shaped rotor are available (see 14.8).

14.4 For special applications, a medium fine abrasive, 240J grit aluminum oxide cloth liner is available (see 14.8). The liner is installed the same way as the fine abrasive, 500J grit aluminum oxide cloth (see 8.2).

14.5 For procurement information regarding a suitable thread, write to: AATCC, P.O. Box 12215, Research Triangle Park NC 27709; tel: 919/549-8141; fax: 919/549-8933; e-mail: orders@aatcc.org.

14.6 Available from Testfabrics Inc., P.O. Box 26, 415 Delaware St., W. Pittston PA 18643; tel: 570/603-0432; fax: 570/603-0433; e-mail: testfabric@aol.com.

14.7 Tensile strength tester as described in ASTM D 76.

14.8 By mutual agreement, the rate and type of abrasion produced in the Accelerotor may be varied by the alternate use of the medium fine abrasive, 240J grit aluminum oxide cloth liner, the use of the shorter S-shaped rotor or the use of one of the 0.26 rad (15 deg.) pitched-blade rotors, and variations of the rotor speed from 157.08 ± 10.48 to 418.88 ± 10.48 rad/s (1500 ± 100 to 4000 ± 100 rpm), but details of these must be made a part of the report of test results.

14.9 It is convenient to mark specimens for cutting by means of square templates made of metal, plastic or cardboard. If available, cutting dies of appropriate dimensions may also be used; however, die-cut specimens should be raveled prior to the edge sealing (see 14.10).

14.10 To prevent loss of specimen weight by fraying, white glue is applied to the pinked or raveled edges of all specimens from a plastic squeeze bottle (see Fig. 3). The cement strip should not exceed 3.2 mm (0.125 in.) in width. For fabrics which have been die-cut, or cannot be pinked, specimens should be raveled 3.2 mm (0.125 in.) along each edge and adhesive applied as above.

14.11 Although they are not included as part of the standard procedure, changes in such characteristics as air permeability, light transmission, visual appearance, hand, etc., could be used for evaluation, depending on the type of fabric and its intended end-use.

Finishes in Textiles: Identification

Developed in 1959 by AATCC Committee RR45; revised 1961, 1962, 1965, 1987; reaffirmed 1969, 1973, 1977, 1985, 2002; editorially revised 1974; editorially revised and reaffirmed 1992, 1997.

1. Purpose and Scope

1.1 This test method gives guidelines for qualitative identification of various finish components present on textile fabrics, yarns or fibers.

1.2 The identification scheme may involve any or all of the following approaches:

1.2.1 Sequential solvent extractions followed by identification of extracts by infrared spectroscopy (IR), gas chromatography (GC), high performance liquid chromatography (HPLC), thin layer chromatography (TLC), nuclear magnetic resonance spectroscopy (NMR) or other instrumental or wet-chemical methods.

1.2.2 Direct measure of elemental or chemical species on fabric by X-ray fluorescence spectroscopy, infrared reflectance spectroscopy, furnace atomic absorption spectroscopy, and other instrumental or wet-chemical analysis methods.

1.2.3 Identification of specific finishing components by chemical spot tests on the textile or extracts from textiles.

2. Uses and Limitations

2.1 This test method is a flexible set of guidelines for identification of textile finishes. Appropriate adjustments and modifications will be needed as finishing chemicals change and as new analytical test methods are developed.

2.2 Any chemical which is on the textile prior to finishing may be present on the finished fabric and could be removed and/or detected as finish. Warp sizes, [e.g., starches, acrylics, waxes, polyesters, poly(vinyl alcohol)], dyes, dye fixatives, binders, spin finishes, natural gums, sugars, optical brighteners, and processing chemicals (e.g., surfactants, bleach stabilizers, dye carriers, and oils) may be present by design or unintentionally. A working knowledge of these chemicals is needed to properly detect and identify them. Where possible, supplier should be consulted for further information.

3. Terminology

3.1 **chemical finish**, n.—chemical material other than colorants and residual

processing chemicals added to textiles to impart desired functional or aesthetic properties to the textile product.

NOTE: Chemical finish will hereafter be referred to as finish.

4. Safety Precautions

NOTE: These safety precautions are for information purposes only. The precautions are ancillary to the testing procedures and are not intended to be all inclusive. It is the user's responsibility to use safe and proper techniques in handling materials in this test method. Manufacturers MUST be consulted for specific details such as material safety data sheets and other manufacturer's recommendations. All OSHA standards and rules must also be consulted and followed.

4.1 Good laboratory practices should be followed. Wear safety glasses in all laboratory areas.

4.2 Use chemical goggles or face shield, impervious gloves and an impervious apron during dispensing and mixing of alkalis, acids and organic solvents. Concentrated acids should be handled only in an adequately ventilated laboratory hood. CAUTION: Always add acid to water.

4.3 Special precautions must be observed when using perchloric acid. All work must be done in an exhaust hood made of non-combustible material. Frequent wash down of the exhaust system is recommended as accumulated perchlorate combinations are often explosive. Addition of dehydrating agents, unless controlled, will lead to the anhydrous acid which is unstable. Care must be taken in handling perchloric acid. Use eye and face protection, and flush any spill or splash to the skin or eyes with water immediately.

4.4 Hexane and methanol are flammable liquids and should be stored in the laboratory only in small containers away from heat, open flames and sparks. These chemicals should not be used near an open flame.

4.5 Carry out reflux procedure in a well ventilated hood with an electrical heater or a water bath as the heating source. Use chemical goggles or face shield, impervious gloves and an impervious apron when handling organic solvents.

4.6 An eyewash/safety shower, organic vapor respirator and a self-contained breathing apparatus should be located nearby for emergency use.

4.7 Care should be taken in handling hot weighing bottles and crucibles. Severe burns can result from skin contact.

4.8 Manufacturer's safety recommendations should be followed when operating laboratory testing equipment.

4.9 Exposure to chemicals used in this procedure must be controlled at or below levels set by governmental authorities [e.g., Occupational Safety and Health Administration's (OSHA) permissible exposure limits (PEL) as found in 29 CFR 1910.1000 of January 1, 1989]. In addition, the American Conference of Governmental Industrial Hygienists (ACGIH) Threshold Limit Values (TLVs) comprised of time weighted averages (TLV-TWA), short term exposure limits (TLV-STEL) and ceiling limits (TLV-C) are recommended as a general guide for air contaminant exposure which should be met (see 14.1).

5. Sample Preparation

5.1 Textile samples should be dried at $105 \pm 1^\circ\text{C}$ and desiccated to constant weight prior to weighing for subsequent extractions.

6. Solvent Extraction Procedures

6.1 Extraction with different solvents is intended to remove as many finishing chemicals as possible in a sequential order. The extraction scheme presented here (see Table I) was chosen on the basis of solvent polarity, solubility, volatility, economy and safety.

6.2 Changes in chemical finishes, safety considerations or personal preferences may dictate the use of other solvents. It is the responsibility of the user to determine which finish types may be removed by different solvents.

6.3 Some finishes may not be soluble in any solvent. An alternate method for insoluble finishes such as fully cross-linked polymers [e.g., some acrylics, polyurethanes, silicones and poly(vinyl acetates)] would be to dissolve all of the fibrous material with a suitable solvent, leaving the residue of finish for further analysis (see AATCC Method 20, Fiber Analysis: Qualitative, Table V).

6.4 Procedure. A weighed textile sample (1-10 g depending on the size of the extractor) is extracted in sequence by the solvents in Table I, using Soxhlet reflux or beaker extractions depending on equipment availability. Extraction times may range from 45 min to several hours

Table I

Group	Solvent	Polarity Index*	Typical Finishing Chemicals Removed
1	Hexane	0.1	Oils, waxes, softeners, silicones
2	1,1,1-Trichloroethane	1.0	Small amounts of unfixed polymers, polyester resins, acrylics, polyurethanes, poly(vinyl acetates)
3	Methanol	5.1	Unfixed cellulose reactants, organic salts, sulfonated organics
4	Water	10.2	Unfixed cellulose reactants, urea, linear starches, poly(vinyl alcohol)
5	0.1 N Hydrochloric acid	10.2	Fixed cellulose reactants, branched starches, inorganic salts

*Burdick and Jackson

NOTE: Some types of fibers may be partially dissolved by the solvents. Pre-checks on the fiber types (see AATCC Method 20) should be made to avoid errors.

depending on the boiling point, exchange rate and knowledge of the history of finish removal for the textile sample in question. The samples should be completely dried before beginning the next solvent in the sequence. After the extractions are complete, each solvent is filtered and evaporated or distilled leaving the residual finish extract. (The extract may be transferred to a weighing pan prior to complete dryness; drying can then be completed in an oven at $105 \pm 1^\circ\text{C}$. Calculate the percent extract as follows:

Extract =

$$100 \times \frac{\text{Weight of Residue}}{\text{Weight of Original Fabric}}$$

NOTE: It may be useful to neutralize the acid extract with dropwise addition of dilute sodium hydroxide to avoid further degradation of the finish during evaporation. The quantitative results will reflect the presence of sodium chloride in the dried residue. In addition, contamination of the solution by sodium carbonate from the reaction of sodium hydroxide with atmospheric carbon dioxide may interfere with interpretation of subsequent infrared spectra.

The percent extract, coupled with subsequent identification, will be useful in distinguishing true finish components from residual non-finishing chemicals that may have been left on the fabric; e.g., natural waxes from softeners.

The extracted finish may be identified by one of the analytical techniques described below.

7. Infrared Spectroscopic Procedures

7.1 Infrared spectroscopy offers a very convenient way to identify extracted finish from textiles. The basis for infrared spectroscopy is the structural information about a compound that can be found from its infrared spectrum. Infrared absorption

bands in the 4000 to 250 wavenumbers region result from specific functional groups in a molecule. These can be compared with spectra of finishes in published or personal libraries. Visual inspection by a trained analyst will quickly identify the general type of finish. Computerized search-and-match capabilities on many infrared systems will be helpful. For more complete information, including typical wavenumbers for comparison of spectra of textile materials, descriptions of newer techniques such as Fourier transform infrared spectroscopy (FTIR), attenuated total reflectance spectroscopy (ATR) and primary references, see 14.2. For representative spectra of chemical finishes, see 14.3.

7.2 Both grating instruments and Fourier transform interferometers are capable of producing high quality spectra for identification and reference purposes. Other spectroscopic techniques such as laser-Raman spectroscopy, NMR spectroscopy and UV-visible spectroscopy may also be utilized, if available, to further identify the extracts. Figs. 1-5 represent infrared spectra run on an FTIR spectrophotometer with MCT detector at a resolution of 4 wavenumbers, signal averaged over 30 scans with HAPPGensel apodization cast on KRS-5 crystal. Fig. 6 represents a proton NMR spectrum of dimethyloldihydroxyethyleneurea (DMDHEU) cellulose reactant in deuterium oxide. Figs. 7 and 8 represent laser-Raman spectra of aqueous solutions of cellulose reactants using an argon ion laser source. Figs. 9 and 10 represent HPLC runs of cellulose reactants using Refractive Index (R.I.) detector, 5 micron C-18 reverse phase pumping at 1.0 mL/min. Fig. 11 represents an X-ray fluorescence spectrum taken from a scanning electron microscope image using a liquid nitrogen cooled detector with an energy range of 0-5 kiloelectron-volts. For other examples of infrared spectra, see 14.3

and 14.4.

7.3 Infrared Sample Preparation.

7.3.1 Techniques. Finish samples can be prepared for infrared analysis by one of the following methods: dissolve the extract in suitable solvent, for analysis as a liquid or as a cast film; grind the textile sample to small particle size and mull in mineral oil; pelletize the extract or ground textile sample into a homogeneous mixture with potassium bromide (KBr) (see 14.2).

7.4 Infrared Analysis.

7.4.1 Obtain a spectrum of the sample or extract prepared by one of the above techniques. The identity of the applied finish is confirmed by comparison of the sample spectrum with known infrared spectra. For more accurate identification, the spectrum of the known compound should be obtained with the same application and extraction history as the unknown finish.

7.4.2 Softeners. Quaternary ammonium compounds, polyethylenes, polyoxyethylene glycols, polyurethanes and polyacrylates are partially soluble in trichloroethylene or 1,1,1-trichloroethane. The extract is concentrated and transferred to a clean KBr disk.

7.4.3 Durable Press Finishing Agents. Since most durable press finishing agents can be extracted with either water or hydrochloric acid, this provides an alternate method for removing finishes for infrared spectroscopy. Approximately 0.2 g fabric, cut into small squares, is refluxed for 5 min in 0.1 N HCl. The solution is then decanted into a 50 mL round-bottom flask with 350 mg spectral grade KBr and evaporated to dryness on a rotary evaporator while the flask is immersed in an ice-salt bath to prevent further hydrolysis. Final drying over phosphorus pentoxide produces a residue that is mixed with more KBr (in a 50 mg:300 mg ratio) and pressed into a disk. A spectrum is obtained and compared to that of known compounds, with spectra of hydrolyzates of known compounds preferable for accurate comparison.

Another method of sample preparation for identification of durable press finishes by infrared spectroscopy is to grind the fabric and pelletize it with spectral grade KBr. Differential infrared spectra relative to ground unfinished fabric are then obtained. KBr disks containing equivalent amounts of specimen in both beams of a double beam spectrophotometer compensate for the fabric bands. Computerized spectral subtraction techniques may also be used to achieve differential spectra.

7.4.4 A quick alternative for acquiring infrared spectra of finishes was described in the 1972 Intersectional Technical Paper Competition presented by AATCC Rhode Island Section (see 14.5). The method relies on the transfer of finish by

solvent from a small rectangle of fabric placed on the surface of an ATR crystal. The solvent is evaporated leaving a thin film of finish residue. The crystal is placed in the ATR accessory holder and the spectrum recorded.

8. Direct Spectroscopic Analysis of Fabric

8.1 With certain types of accessories and spectroscopic techniques, it is possible to acquire direct spectra of both the fabric substrate and the finishing components on it. These techniques may include infrared reflectance with ATR and diffuse reflectance accessories, photoacoustic spectroscopy (PAS), laser-Raman spectra, electron spectroscopy for chemical analysis (ESCA) and near infrared reflectance spectroscopy (NIR). In many cases, computerized spectral subtraction techniques are useful in identifying small amounts of finish on fabric.

9. Chromatographic Procedures

9.1 Chromatography is a very useful method for the separation and tentative identification of some of the finishes on textile fabrics. After separation is accomplished, identification is made by chromatographic comparison to known compounds either in pure form or after being subjected to the same application and extraction history as the unknown; identification requires comparison under at least two different sets of chromatographic conditions. Alternatively, the chromatographic peak of interest may be identified spectroscopically on line or after isolation. For most analyses, Soxhlet extracted residues or their derivatives may be analyzed by GC, HPLC or TLC. Applications included in this section are simple techniques for use with basic GC or HPLC. For information on more complex and diverse instruments and methods see 14.2.

9.2 Gas Chromatography. Gas Chromatography involves the separation of a mixture of volatile substances as it is carried through a column of surfaces that interact differentially with the various components of the mixture.

9.2.1 Formaldehyde. Formaldehyde released from fabrics may be detected by GC. A fabric sample is enclosed in a vial with a defined headspace and conditioned under precise temperature and humidity. Samples of the headspace gas are injected for GC analysis. This system can also be used to determine the amount of methanol released by hydrolysis of methylated N-methylol groups found in some durable press resins. Since the FID signal from formaldehyde is not very strong, a methanizer may be placed between the column and the flame for conversion of formaldehyde to methane. Alcohols are also converted to corresponding hydro-

carbons. Conditions for formaldehyde analysis are:

Column: 3 m Porapak T
Injection time: 9 s
Bath: 65°C
Needle: 150°C
Oven: 120°C
Injection port: 180°C
Detector: 480°C

A photoionization detector may also be used for increased sensitivity. For further information on this type of analysis see 14.2.

9.2.2 Softeners, Lubricants, and Emulsifiers. Solvents such as hexane or Freon 113 are used to extract softeners, lubricants and emulsifiers from fabrics. These three groups of products are commonly made from fatty acids and fatty acid esters or their derivatives. Some of these compounds can be chromatographed directly and some must be made into derivatives to be better detected by GC.

Other long chain fatty compounds are more easily analyzed after derivatization. Monocarboxylic acids are esterified, usually with methanol, and these methyl esters are analyzed as follows: Column: 45 m × 0.25 mm DEGS open tubular column. Column temperature: 180°C.

Silylation, another method of derivatization of fatty acids and fatty alcohols, forms non-polar, volatile, thermally stable ethers. These ethers form easily, and the reactions are performed in screw-capped vials. The column used for analysis is chosen according to the type of compound that was silylated. The silyl derivatives of glycerol and mono- and diglycerides for example, are chromatographed on a 1 ft OV-1 column. Quaternary ammonium salt derivatives require a 5% SE-30 column. For more detailed discussion of this application see 14.2.

Paraffin waxes, often used as softeners, lubricants, water repellents and winding lubricants are analyzed directly by GC. Instrument conditions for paraffin wax or alpha-olefin C-30+ type hydrocarbons are:

Column: 6 ft × 1/8 in. stainless steel (SS) OV-101, 5%
Column temperature: 200C-290°C at 10C/min then hold 11 min
Detector: Flame Ionization Detector (FID) at 350°C
Injection port: 350°C
Carrier: Helium
Flow: 30 mL/min

Polyols. Water extracts of fabrics may be analyzed by GC to detect ethylene and diethylene glycols. Glycols are frequently used with or in durable press resins. Instrument conditions are:

Column: 6 ft × 1/8 in. stainless steel (SS) Tenax GC, 60/80 mesh
Column temperature: 200°C
Detector: Flame Ionization Detector (FID) at 250°C

Table II—Solvent Systems for Separating Dye Classes

Dye Class	System ^a
Acid	Propanol:Acetone:Water:Acetic Acid (5:5:3:1) Pyridine:Butyl Acetate:Water (9:6:5) Butanol:Ethanol:Water (2:1:1) Propanol:aqueous ammonia (28%) (1:1)
Basic	Butanol:Ethanol:Water:Acetic Acid (10:1:1:1) Benzene:Methanol (9:1)
Direct	Propanol:Acetone:Water:Acetic Acid (5:5:3:1) Butyl Acetate:Pyridine:Water (5:5:2) Butanol:Acetone:Water (5:5:3) Organic Layer of Butanol:Water:aqueous ammonia (2:1:1)
Disperse	Benzene:Acetone (9:1) Benzene:Chloroform:Acetone (5:2:1)
Plastic	Carbon Tetrachloride:Benzene (1:9)
Solvent	Carbon Tetrachloride:Benzene (1:1)
Vat	Toluene:Pyridine (6:4) Benzene:Nitrobenzene:Acetone (8:1:1) Butanol:Butyl Acetate: Nitrobenzene:Acetone (3:3:3:1) Butyl Acetate:Pyridine:Water (5:4:2) Benzene:Pyridine:Dioxane:Acetone (20:2:2:1)

^a Ratios are volumes of solvents; e.g., to make an eluent such as propanol:acetone:water:acetic acid (5:5:3:1), five volumes of propanol, five volumes of acetone, three volumes of water, and one volume of acetic acid are mixed (see 14.2).

Injection port: 250°C

Carrier: Helium at 30 mL/min

9.3 Thin Layer Chromatography Procedures. TLC is the separation of components of a substance by differential travel in a solvent phase over an absorbent plate and can be an analytical tool for a variety of textile extracts such as surfactants, dye carriers, resins, polyester oligomers and, more commonly, dyes. Reasons for utilizing TLC include small sample size, preliminary work for HPLC method development or two-dimensional separation. For additional information see 14.2.

9.3.1 TLC Plates. For simplicity and uniformity in TLC separations pre-coated plates can be purchased from various manufacturers. The plates may be coated with absorbents such as alumina, cellulose, octadecyl groups (C-18) bonded to silica, or silica gel. A coating of C-18 bonded to silica is suitable for resin analysis. Dual phase TLC plates with the two phases at right angles to each other may be used for separation of emulsified products such as waxes or latex.

9.3.2 Size. The sample size should be very small. Use of a microliter syringe is recommended. When analyzing the fabric extracts it may be necessary to place

successive spots on top of each other. Spots should be thoroughly dried before developing.

9.3.3 Solvent System. Once the fabric extract is obtained and the chromatographic plate or strip is spotted with the sample, determine the correct eluent or solvent. The solvent system used in TLC relates directly to that used in liquid chromatography. For examples of solvent systems for various textile chemicals, refer to Table I. Table II gives some solvent systems for various dyes. For additional information on solvent systems see 14.2.

9.3.4 Development. Place the TLC plate and solvent in a sealed developing chamber which can be a small inexpensive jar with a lid. Better resolution is achieved by using the smallest application volume possible and by placing a strip of filter paper which is solvent saturated in the chamber. The solvent level should be slightly lower than the level of sample spotted on the plates.

9.3.5 Detection. The separated components are detected visually (as with dyes), by UV light or saturation of the plate with iodine vapor. Saturate the plate with iodine by placing a few crystals in the bottom of the detection chamber. Other chemicals for the detection of noncolored components are available from TLC suppliers. Examples are Dragendorff reagent used for the detection of amines and phosphomolybdic acid solution and sulfuric acid can be used for general purpose detection (see 12.1).

9.4 High Performance Liquid Chromatography Procedures. Several fabric finishes and extracts can be detected by HPLC, which relies on separation of components carried by a liquid phase through a column and detection by UV or RI. Formaldehyde, resins and other auxiliaries as well as residual chemicals from prior processing can be detected.

9.4.1 Formaldehyde. Formaldehyde (CH₂O), extracted from the fabric in water, precipitated as formaldehyde 2,4-dinitrophenylhydrazone, and analyzed by liquid chromatography, is detectable at very low levels. To prepare the reference standard, place 50 mL of a 2% formaldehyde solution in a beaker with 50 mL of a 0.24% solution of 2,4-dinitrophenylhydrazine (DNPH) hydrochloride (in 30% perchloric acid). After 1 h at room temperature filter the precipitated hydrazone, rinse first with water and then with ethanol, and dry. Dissolve all of the precipitate in methylene chloride and analyze by HPLC. To prepare the sample place 50 mL of extract in a 250 mL separatory funnel with 10 mL of 0.24% 2,4-DNPH (in 30% perchloric acid). After 1 h, extract the hydrazone with methylene chloride, condense the extract and analyze. Fig. 12 is a chromatogram of standard aldehydes reacted with 2,4-DNPH. Instrument conditions are:

Column: CN (reverse phase)
Flow rate: A range of 1-1.5 mL/min
Eluent: 40% water/42% methanol/
18% isopropyl alcohol
Detector: UV at 254 nm

9.4.2 Resin Finishes. Some resins can be extracted with water. HPLC is ideal for critical comparison of resin finishes. See an example in Fig. 9 for a chromatogram of DMDHEU resin.

The following conditions were used:

Column: C-18 (reverse phase)
Eluent: 100% water
Detector: Refractive index
Flow rate: 1.0 mL/min

Under these conditions, other finishes including uron, triazones and glycols in the resin can also be identified.

10. Elemental Analysis

10.1 Determination of the elemental content of finished textiles can be used to indicate the presence of various finishing agents. Increased nitrogen content on treatment of fabric, as determined by traditional Kjeldahl analysis or by instrumental nitrogen analyzers, can suggest the presence of durable press reactants. Nonmetallic elements such as phosphorus, chlorine and bromine from flame

Table III—Chemical Spot Tests

Substance	Reagents Employed	Reaction	Reference Note
Formaldehyde	Chromotropic acid and sulfuric acid	Purple color	14.6, 14.7
	Phenylhydrazine hydrochloride, hydrochloric acid, and ferric chloride	Cherry red color	14.8
Starch	Iodine and potassium iodide in water	Purple color	14.2
Urea	<i>p</i> -Dimethylaminobenzaldehyde in methanol and hydrochloric acid	Yellow color	14.2
Zinc	Dithiazone (diphenylthiocarbozone) in acetone	Cherry red color	14.2, 14.9
Zirconium	Alizarin in alcohol	Red to red-violet precipitate	14.9
Magnesium	Quinalizarin in methanol, and sodium hydroxide	Blue precipitate	14.2, 14.9
Aluminum	Aluminum and ammonium acetate	Red color	14.2, 14.9
Iron	Hydrochloric acid and potassium ferrocyanide	Deep blue color	14.2, 14.9
	Hydrochloric acid and potassium thiocyanate	Deep red color	14.2, 14.9
Ammonium ion	Hydrochloric acid and heat	Yellow color	
	Sodium hydroxide and heat	Odor of ammonia	14.2
Chloride ion	Silver nitrate and nitric acid	White to gray precipitate	14.2, 14.9
Nitrate ion	Ferrous sulfate and sulfuric acid	Brown ring forms	14.2, 14.9
Phosphate ion	Ammonium molybdate, benzidine hydrochloride and ammonium acetate	Blue color	14.2, 14.9
Sulfate ion	Barium chloride and hydrochloric acid	White precipitate	14.2
*Phosphorus	Nitric acid and ammonium molybdate	Yellow color	14.2, 14.9
*Nitrogen	Ferrous sulfate and ferric chloride	Deep blue color	14.2, 14.9
*Sulfur	Sodium nitroferrocyanide	Red violet color	14.2, 14.9
*Chlorine	Silver nitrate in water, and nitric acid	White to gray precipitate	14.2
*Bromine	Silver nitrate and nitric acid	Yellow precipitate	14.2
Polyvinyl alcohol	Chromic acid and sodium hydroxide	Brown stain	14.2
	Iodine and potassium iodide and boric acid	Purple color	14.2
Polyvinyl acetate	Iodine and potassium iodide	Red-brown color	14.2
Sodium carboxymethyl-cellulose	Uranyl nitrate	Yellow precipitate	14.2
Proteins	Potassium hydroxide, heat, copper sulfate	Violet color	14.2
Methylol melamine	Phenylhydrazine hydrochloride, hydrochloric acid, and ferric chloride	Light pink color	14.8
Methylol urea	Phenylhydrazine hydrochloride, hydrochloric acid, and ferric chloride	Pale brown color	14.8
Methylol ethylene	Phenylhydrazine hydrochloride, hydrochloric acid, and ferric chloride	Deep red brown color	14.8

*Sodium Fusion Method

retardant finishes, as well as fluorine from soil-release finishes, can be analyzed by chemical digestion or oxygen flask combustion followed by titration, specific ion analysis or other instrumental methods.

Metals on fabric, such as antimony or titanium from flame retardants, magnesium or zinc from resin catalysts and sodium or potassium salts of other finishes, can be determined by acid extractions or dry ashing followed by atomic absorption (AA) analysis or inductively coupled plasma (ICP) analysis. X-ray fluorescence can be used to determine the content of many elements directly on the fabric simultaneously.

11. Chemical Spot Tests

11.1 Qualitative spot tests are detection methods based on chemical reactions employing a drop of test solution or reagent (Table III). The chemical reaction usually results in a characteristic color or odor. Spot test methods should be sensitive, reliable and capable of being conducted satisfactorily with small sample amounts and simple equipment. Identification limit is the minimum quantity of a substance dissolved in the test solution which can be detected. Spot tests are not designed to furnish a complete analysis of the kind or amounts of all constituents in a given material, but rather to determine whether or not certain elements, compounds or classes of compounds are present or absent. The analyst is cautioned to run a blank and a known sample

containing the substance in question, along with the unknown sample. Further, tests should be repeated for confirmation of reliability.

11.2 Several procedures are available for spot tests: (1) a drop of test solution and a drop of reagent can be brought together on a nonporous surface; (2) a drop of test solution can be placed onto a medium impregnated with a reagent; (3) a drop of reagent can be placed on a solid specimen; (4) a drop of reagent or a strip of reagent paper can be exposed to the action of gases evolved from the test solution or solid specimen (see Table III); and (5) a drop of solution can be placed on a textile and color development observed on white filter paper held beneath the specimen. For analysis of textile finishing agents, the sample may be prepared for one of the above treatments in several ways. First, the test may be carried out directly on a fabric sample with no preliminary preparation. Second, the fabric may be extracted with a selected solvent and the test carried out with the extract as the test solution. Third, the fabric (or textile sample) may be destroyed by dry or wet ashing methods, and the residue tested in solid or dissolved form. Finally, a fusion method may be used for substances which form insoluble oxides on ignition. This method involves heating the sample with metallic sodium or potassium.

12. Report

12.1 Report any finish or finish components detected. The report should in-

clude solvents used for extraction and method of extract analysis (including instrument conditions) or should state other specific techniques employed.

13. Precision and Bias

13.1 Precision and bias statements are not applicable because data are not generated by this method.

14. Notes and References

14.1 Available from Publications Office, ACGIH, Kemper Woods Center, 1330 Kemper Meadow Dr., Cincinnati OH 45240; tel: 513/742-2020.

14.2 *Analytical Methods for a Textile Laboratory*, Third Edition, 1984, American Association of Textile Chemists and Colorists, Research Triangle Park NC.

14.3 *Infrared Spectra for the Identification of Chemical Finishing Agents from Textiles*, Part I, ARDS-S-47, October 1974, Agricultural Research Service, U.S. Dept. of Agriculture.

14.4 *Handbook of Chemical Specialties*, John E. Nettles, Chapter on Textile Fiber Processing, Preparation and Bleaching, John Wiley & Sons, New York.

14.5 *Textile Chemist and Colorist*, Vol 5, No. 12, December 1973, p279.

14.6 Walker, J. F. *Formaldehyde*, Reinhold, NY, 1964.

14.7 Feigl, F., *Spot Tests in Organic Analysis*, 7th Edition, Elsevier, Amsterdam, 1966.

14.8 VanLoo, W. J., Jr., et al, *American Dyestuff Reporter*, Vol. 45, 1956, p397.

14.9 Feigl, F., *Spot Tests in Inorganic Analysis*, 7th Edition, Elsevier, Amsterdam, 1966.

Appendix 1—Spectra

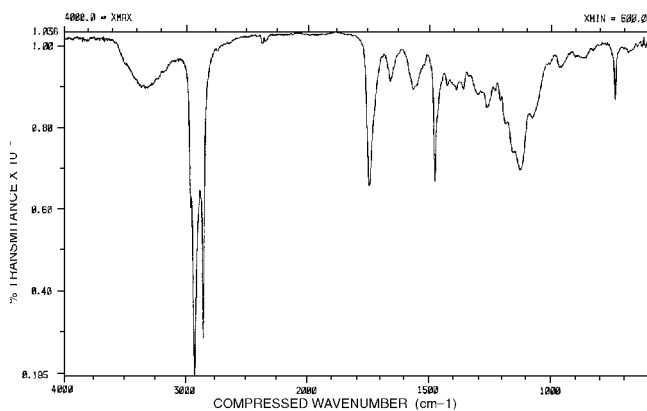

Fig. 1—Infrared spectrum of a fatty ester softener.

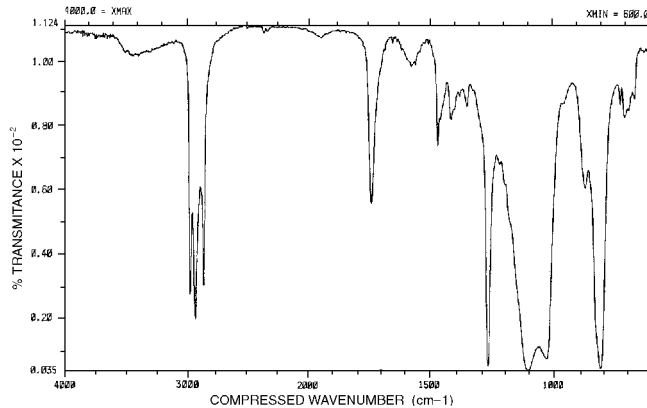

Fig. 2—Infrared spectrum of a silicone softener.

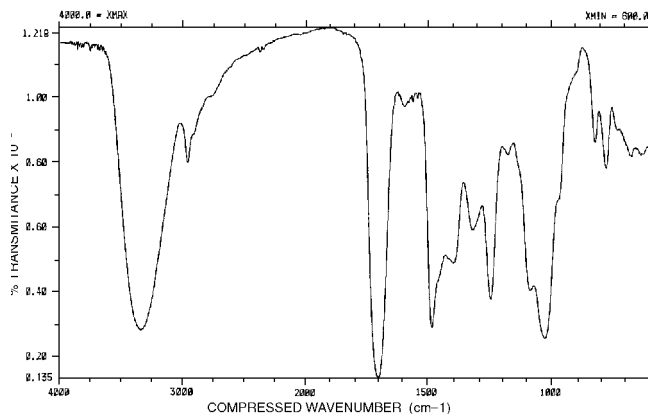

Fig. 3—Infrared spectrum of a DMDHEU cellulose reactant.

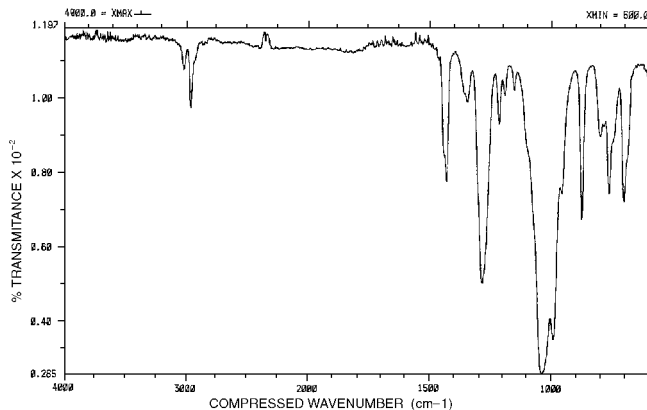

Fig. 4—Infrared spectrum of tris (1,3 dichloropropyl) phosphate flame retardant.

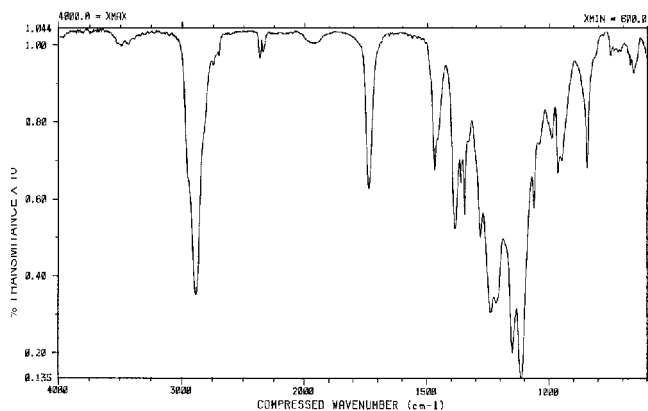

Fig. 5—Infrared spectrum of a fluorochemical soil release agent.

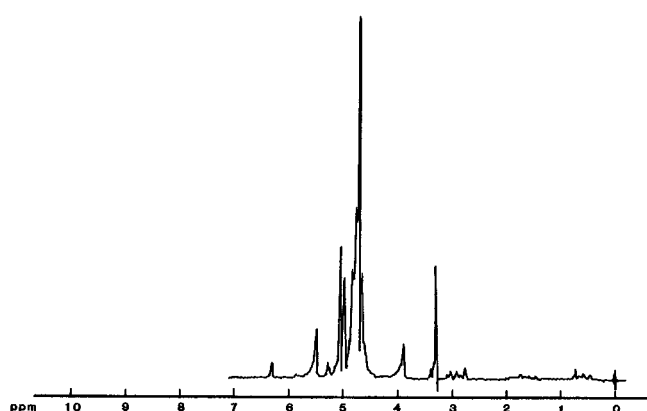

Fig. 6—Proton NMR spectrum of DMDHEU cellulose reactant.

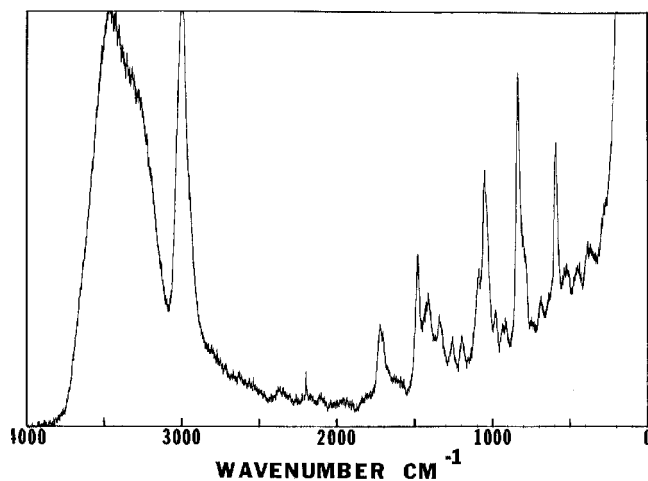

Fig. 7—Laser-Raman spectrum of DMDHEU cellulose reactant.

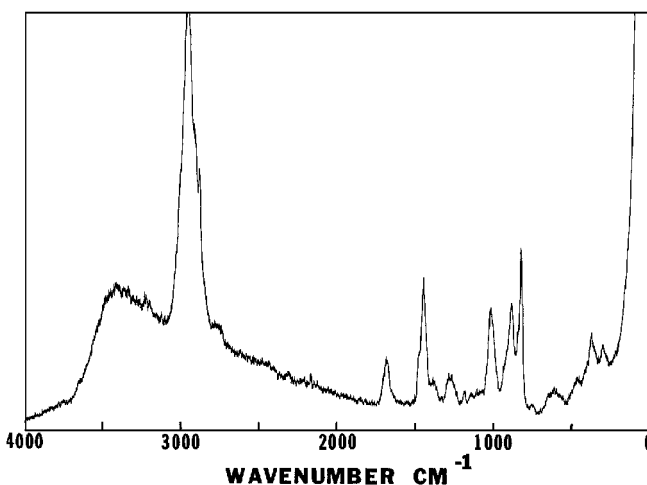

Fig. 8—Laser-Raman spectrum of methyl carbamate cellulose reactant.

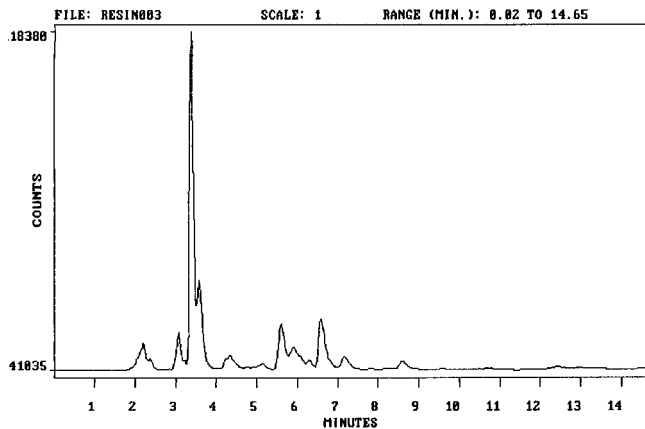

Fig. 9—High performance liquid chromatogram of DMDHEU cellulose reactant.

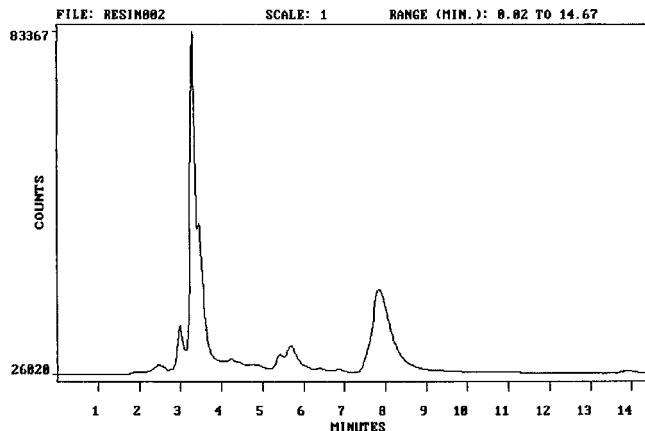

Fig. 10—High performance liquid chromatogram of a glycolated DMDHEU cellulose reactant.

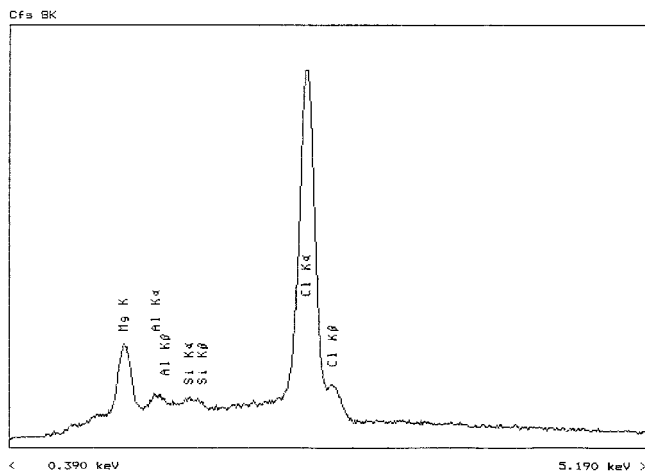

Fig. 11—X-Ray fluorescence spectrum of a magnesium chloride-aluminum chloride catalyst.

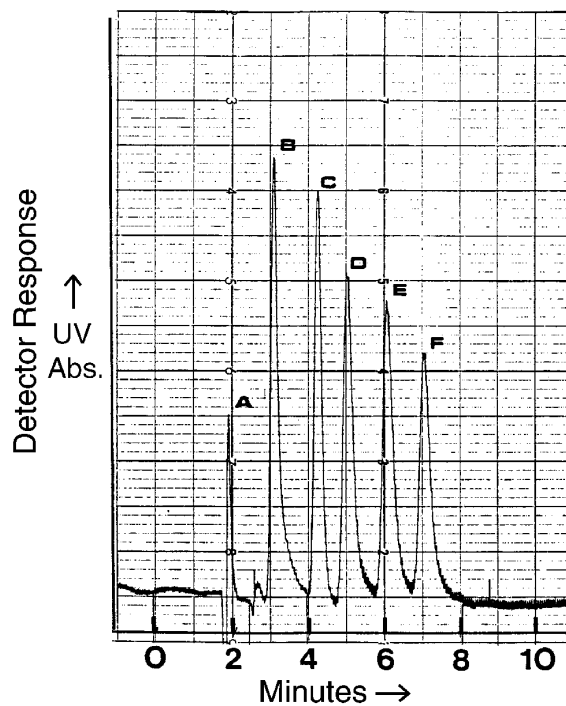

Fig. 12—Separation of 2,4-dinitrophenylhydrazine derivatives of aldehydes: (A) solvent peak; (B) glyceraldehyde DNPH; (C) formaldehyde DNPH; (D) acetaldehyde DNPH; (E) propionaldehyde DNPH; (F) isobutyraldehyde DNPH.

Dimensional Changes in Commercial Laundering of Woven and Knitted Fabrics Except Wool

Developed in 1960 by AATCC Committee RA42; revised 1967, 1980, 1988 (with title change), 1995, 1997, 1999, 2001; reaffirmed 1972, 1975; editorially revised 1973, 1974, 1975, 1982, 1983, 1984, 1989, 1990, 1991, 1994, 2004, 2005; technical correction 1984; editorially revised and reaffirmed 1993. Related to ISO 5077.

1. Purpose and Scope

1.1 This test method is used to determine the dimensional changes in woven and knitted fabrics made of fibers other than wool when subjected to laundering procedures commonly used in a commercial laundry. A range of laundering test procedures from severe to mild is provided to allow simulation of the various types of commercial launderings available. Five drying test procedures are established to cover the drying techniques used.

1.2 These tests are not accelerated and must be repeated to determine dimensional changes after multiple launderings.

2. Principle

2.1 The dimensional change of woven and knitted fabric specimens subjected to washing, drying and restoration procedures typical of commercial laundering are determined by measuring changes in bench mark distances applied to the fabric before laundering.

3. Terminology

3.1 **commercial laundering**, n.—a process by which textile products or specimens may be washed, rinsed, bleached, dried and pressed in commercial laundering equipment, typically at higher temperatures and pHs and longer times than used for home laundering.

3.2 **dimensional change**, n.—a generic term for changes in length or width of a fabric specimen subjected to specified conditions. (see also *shrinkage* and *growth*).

3.3 **growth**, n.—a dimensional change resulting in an increase in the length or width of a specimen.

3.4 **laundering**, n.—of textile materials, a process intended to remove soils and/or stains by treatment (washing) with an aqueous detergent solution that normally includes rinsing, extracting and drying.

3.5 **shrinkage**, n.—a dimensional change resulting in a decrease in the length or width of a specimen.

3.6 **wool**, n.—used in the generic sense,

fiber from the fleece of the sheep or lamb, hair from the Angora or Cashmere goat, rabbit hair and the specialty hair fibers from camel, alpaca, llama and vicuna.

4. Safety Precautions

NOTE: These safety precautions are for information purposes only. The precautions are ancillary to the testing procedures and are not intended to be all inclusive. It is the user's responsibility to use safe and proper techniques in handling materials in this test method. Manufacturers MUST be consulted for specific details such as material safety data sheets and other manufacturer's recommendations. All OSHA standards and rules must also be consulted and followed.

4.1 Good laboratory practices should be followed. Wear safety glasses in all laboratory areas.

4.2 The 1993 AATCC Standard Reference Detergent may cause irritation. Care should be taken to prevent exposure to skin and eyes.

4.3 Manufacturer's safety recommendations should be followed when operating laboratory testing equipment.

5. Apparatus and Materials

5.1 Apparatus.

5.1.1 Wash wheel of the reversing type (see 12.1).

5.1.2 Flatbed press measuring 60 × 125 cm or larger. Any flatbed press capable of pressing specimen 55 cm square may be used as an alternative. The flatbed press is maintained at a temperature not less than 135°C (see 12.2).

5.1.3 Dryer of the rotary tumble type, having a cylindrical basket approximately 75 cm in diameter and 60 cm in length and rotating at approximately 35 rpm. The dryer is provided with a means of maintaining a drying temperature of 60 ± 11°C measured in the exhaust vent as close as possible to the drying chamber.

5.1.4 Conditioning/drying rack with pull-out screen or perforated shelves (see 12.3).

5.1.5 Facilities for drip and line drying.

5.1.6 Hydro-extractor, centrifugal extractor of the laundry type with a perforated basket, 29.0 cm deep × 51.0 cm diameter with an operating speed of 1700 rpm (see 12.4).

5.1.7 Ballast of 92 × 92 ± 3 cm hemmed pieces of bleached cotton sheeting (Wash load ballast type 1) or 50/50 polyester/cotton bleached and mercerized

plain weave (Wash load ballast type 3) (see 12.12 and 12.13).

5.2 Measuring devices.

5.2.1 Indelible ink marking pen (see 12.5) for use with suitable rule, tape, marking template (see 12.6).

5.2.2 Tape or rule with divisions in millimeters or smaller increment (see 12.6).

5.2.3 Needle and sewing thread can be used to make bench marks (see 12.11).

5.2.4 Digital Imaging System (see 12.14).

5.3 Materials.

5.3.1 Detergent, alkylarylsulfonate type, or 1993 AATCC Standard Reference Detergent (see 12.7 and 12.13).

5.3.2 Hand iron, electric, steam or dry, weighing approximately 1.4 kg.

6. Test Specimens

6.1 Sampling.

6.1.1 Test three specimens of each sample. Where possible, each specimen should contain different groups of lengthwise and widthwise yarns.

6.1.2 Fabrics that are badly distorted in their unlaundered state may give deceptive dimensional change results when laundered by any procedure. Therefore, it is recommended that the specimen not be taken from such areas or, if used, the results considered as indicative only.

6.1.3 In cases of dispute or litigation: Pre-condition test specimens as directed in ASTM D 1776, Standard Practice for Conditioning and Testing Textiles, prior to conditioning. Otherwise, condition test specimens for at least 4 h in an atmosphere of 21 ± 1°C and 65 ± 2% RH by laying each test specimen separately on a conditioning rack.

6.2 Size, Preparation and Marking.

6.2.1 The size and preparation of test specimens will vary depending upon the type of fabric being tested.

6.2.2 For woven and warp knit fabrics at least 60 cm wide: Preferably, cut three 60 × 60 cm test specimens. Mark each specimen with three 50 cm pairs of bench marks parallel to the length of the fabric, and three 50 cm pairs of bench marks parallel to the width of the fabric. Each bench mark must be at least 8 cm from all edges of the test specimens. Pairs of bench marks in the same direction must be approximately 15 cm apart (see Fig. 1). Alternatively, if sample size is limited, cut three 40 × 40 cm test specimens. If using this size, mark each specimen with three 25 cm pairs of bench marks parallel to the length of the fabric, and three 25

cm pairs of bench marks parallel to the width of the fabric (see 12.8). Each bench mark must be at least 5 cm from all edges of the test specimens. Pairs of bench marks in the same direction must be approximately 12 cm apart (see Fig. 1).

6.2.3 For woven and warp knit fabrics under 60 cm wide: Cut three test specimens that are each 60 cm in length and the full width of the fabric. Mark each test specimen with 50 cm bench marks parallel to the length of the fabric. The bench marks should be at least 12 cm apart and at least 5 cm from the fabric edges. For the width direction select bench mark distances that fit within 5 cm in from the edges. Place three such bench marks on each test specimen in the width direction. Bench marks in the width direction should be at least 15 cm apart and at least 8 cm from the top and bottom edges of the fabric (see Fig. 2).

6.2.4 Flat and circular knit fabrics: Tubular finished knit fabric samples representing goods used in the tubular state; i.e., underwear, sweat shirts, polo shirts, etc., should be tested in the tubular state. Cut three specimens, each 60 cm in length. Tubular finished knit fabrics representing goods used in the slit open width state; i.e., dresses, slacks, suits, etc., are to be slit and handled flat. After slitting fabric, cut three test specimens according to 6.2.2 or 6.2.3. Mark specimens as in 6.2.2 or 6.2.3. For fabrics which will run or ladder, it is suggested that the edges be sewn with stitch type 505 (see 12.11).

6.3 Original Measurement.

6.3.1 Measure by using one of the following options:

Option 1: Measure and record the distance between each pair of bench marks with suitable tape or rule to the nearest millimeter or smaller increments. This is Measurement A.

Option 2: If using a tape or template ruled directly in percent dimensional change, original measurements are not re-

quired. In case of narrow fabrics less than 38 cm wide, measure and record width.

7. Procedure

7.1 Table I summarizes the alternative laundering, drying and restoration procedures. Details of laundering procedures are summarized in Table II.

7.2 Washing.

7.2.1 Place the specimens in the wash wheel with sufficient ballast or other fabrics similar to test specimens to make a 1.80 ± 0.07 kg load for Tests Ic, IIc, IIIc, IVc and Vc. For Test VIc, a load consisting of test specimens and ballast to make a load of 9.0 ± 0.2 kg shall be used. Add 66 ± 1 g of 1993 AATCC Standard Reference Detergent (see 12.7). In soft water areas this may be reduced to avoid excessive sudsing. Start wash wheel and note the time. Immediately add water at $41 \pm 3^\circ\text{C}$ to the wheel to a level of 18.0 ± 1.0 cm. When this water level has been reached, inject steam into the wheel until the temperature reaches that shown in Row B, Table II. This level will be increased by condensed steam.

7.2.2 Test Ic. Stop the wash wheel after 15 min (Row A, Column 1 of Table II) and drain. Refill the machine to a level of 22.0 ± 1.0 cm with water at a temperature at $41 \pm 36^\circ\text{C}$ and start the machine. Inject steam, if necessary, to maintain that temperature during the rinse. Stop the machine at the end of the time shown in Row C, Column 1 of Table II. Repeat this procedure for the second rinse using the times and temperatures shown in Rows E and F, Column 1 of Table II.

7.2.3 Tests IIc, IIIc, IVc and Vc. The machine runs continuously for the time shown in Row L of Table II. Begin to drain off the detergent solution at the end of the suds cycle at a rate that substantially empties the wash wheel of solution at the end of the time shown in Row A of Table II. Measure the time elapsed from

the time the wash was started in 7.2. Refill the machine to a level of 22.0 ± 1.0 cm with water at a temperature of $41 \pm 3^\circ\text{C}$. When this water level has been reached, inject steam, if necessary, to maintain that temperature during the rinse. Drain off the water at a rate that substantially empties the wash wheel at the end of the sum of the times shown in Rows A and C measured from the time the wash wheel was started. Immediately refill the wash wheel to a level of 22.0 ± 1.0 cm with water at $41 \pm 3^\circ\text{C}$. When the water level has been reached, inject steam, if necessary, to maintain that temperature during the rinse. Drain off the water at a rate that substantially empties the wash wheel at the end of the sum of the times from the time the wash wheel was started.

7.2.4 Test IIc or Test IIIc. The wash wheel is stopped after the second rinse water has drained. For the wet tumble cycle in Tests IVc and Vc, the wash wheel continues to run without further addition of water and is stopped 60 min from the time the wash wheel is started. In each of the above operations, the draining time is included in the running time. Draining is to be completed by the end of the time shown in Row L. The time to fill and drain the wash wheel is included in the time of the suds cycle and the two rinses in Tests IIc, IIIc, IVc and Vc, in which the machine is run continuously from the start of the test.

7.2.5 Test VIc. Stop the wash wheel after 10 min (Row A, Column 6 of Table II) and drain. Refill the machine to a level of 22.0 ± 1.0 cm with water at a temperature at $60 \pm 3^\circ\text{C}$ and start the machine. Inject steam, if necessary, to maintain that temperature during the rinse. Stop the machine at the end of the time shown in Row C, Column 6 of Table II. This procedure is repeated for the second, third and fourth rinses using the times and temperatures shown in Rows E-J, Column 6 of Table II.

7.3 Drying.

7.3.1 The specimens may be dried by

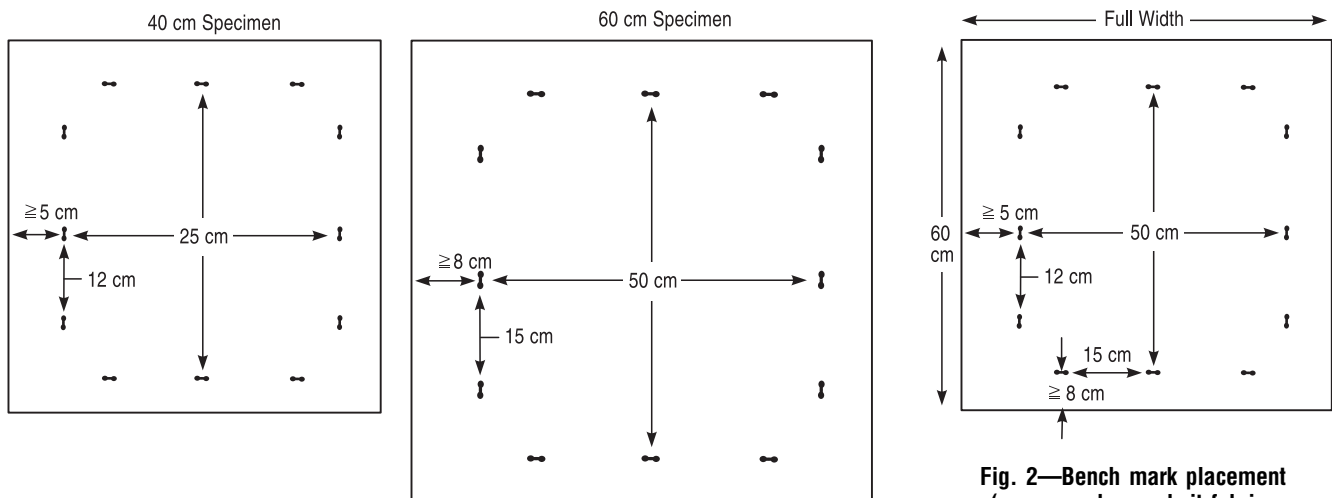

Fig. 1—Bench mark placement (woven and warp knit fabrics at least 60 cm wide).

Fig. 2—Bench mark placement (woven and warp knit fabrics under 60 cm wide).

Table I—Commercial Washing, Drying and Restoration Procedures

Tests	Washing Temperatures	Total Time	Drying	Restoration
Ic	41 ± 3°C	30 min	A. Tumble	0. None
IIc	51 ± 3°C	45 min	B. Line	1. Hand Iron
IIIc	63 ± 3°C	45 min	C. Drip	2. Flatbed Press
IVc	74 ± 3°C	60 min	D. Screen	
Vc	99 ± 3°C	60 min	E. Flatbed Press	
VIc	60 ± 3°C	32 min		

Table II—Washing Test Conditions

	TEST					
	Ic	IIc	IIIc	IVc	Vc	VIc
WASH						
(A) Suds Time (min)	15	30	30	40	40	10
(B) Cycle Temp	40 ± 3°C	52 ± 3°C	63 ± 3°C	74 ± 3°C	98 ± 3°C	60 ± 3°C
FIRST RINSE						
(C) Time (min)	5	5	5	5	5	10
(D) Temp	41 ± 3°C	41 ± 3°C	41 ± 3°C	41 ± 3°C	41 ± 3°C	60 ± 3°C
SECOND RINSE						
(E) Time (min)	10	10	10	10	10	3
(F) Temp	41 ± 3°C	41 ± 3°C	41 ± 3°C	41 ± 3°C	41 ± 3°C	49 ± 3°C
THIRD RINSE						
(G) Time (min)	none	none	none	none	none	3
(H) Temp						38 ± 3°C
FOURTH RINSE						
(I) Time (min)	none	none	none	none	none	3
(J) Temp						38 ± 3°C
WET TUMBLE						
(K) Time (min)	none	none	none	5	5	3
Total Running Time						
(L) Time (min)	30 ^a	45 ^b	45 ^b	60 ^b	60 ^b	32 ^a

^a Machine is stopped between cycles.

^b Machine operates continuously. Because the machine runs continuously from the start of the test, the time to fill and drain the machine is included in the time of the suds cycle and the two rinses in Test IIc, IIIc, IVc and Vc.

any one of the five procedures shown in Table I (see 12.9), except for Test VIc, use procedure A only (Tumble Dry). The choice of drying procedure should be governed by the intended end-use of the fabric. For drying procedures A, B, D and E, remove the load from the wash wheel and centrifuge the load for a minimum of 3 min.

7.3.2 (A) Tumble Dry. Place the extracted load in a tumble dryer at 60 ± 11°C for 30 min or until dry.

7.3.3 (B) Line Dry. Hang each extracted specimen by two corners with the fabric length in the vertical direction. Allow the test specimens to hang in still air at room temperature until dry.

7.3.4 (C) Drip Dry. Remove the non-extracted specimens from the wash wheel and hang by two corners, with the fabric length in the vertical direction. Allow the test specimen to hang in still air at room temperature until dry. This procedure is preferable for durable press fabrics.

7.3.5 (D) Screen Dry. Spread each extracted specimen on a horizontal screen or perforated surface, removing wrinkles but not distorting or stretching, and allow to dry in still air at room temperature.

7.3.6 (E) Flatbed Press Dry. Smooth the extracted specimens to remove wrinkles, without distorting or stretching, and

press dry on the flatbed press according to the following cycle:

- Five s steam with head up.
- Five s dry hot press with head down with steam at a temperature of 148 ± 3°C.
- Five s vacuum, steam off, head down.
- Five s vacuum, steam off, head up.

7.4 Conditioning and Restoration.

7.4.1 After the completed washing and drying intervals, precondition (see 6.1.3) and condition specimens for at least 4 h by laying each specimen separately on a conditioning rack in an atmosphere of 21 ± 1°C and 65 ± 2% RH.

7.4.2 Hand Iron. If the specimens are wrinkled and the appearance is such that the consumer would expect to iron the garment made from the sample material, test specimens may be ironed prior to re-measurement of the distance between bench marks.

7.4.2.1 Due to the extremely high variability of hand ironing procedures performed by individual operators (no standard test method exists for hand ironing procedures), the reproducibility of dimensional change results after hand ironing has been found to be extremely poor. Consequently, caution is advised when comparing dimensional change results after laundering and hand ironing, reported

by different operators.

7.4.2.2 Hand ironing is intended primarily for the evaluation of fabrics that require ironing after laundering. Use safe ironing temperatures appropriate to the fibers in the fabric being ironed. See Table I, Safe Ironing Temperature Guide, in AATCC Method 133, Colorfastness to Heat: Hot Pressing. Exert only that pressure during pressing which is necessary to remove wrinkles.

7.4.3 Pressing, Test VIc. Cool the dry specimen a minimum of 5 min and then moisten sufficiently with water to allow good pressing. Wet the specimen using a spray nozzle set for fine mist. Let the specimen remain in this condition for 5 min, smooth it to remove wrinkles without distortion and then press it either with a flatbed press or hand iron. Set the head of the press or the hand iron at a temperature of 120-150°C. When a hand iron is used, do not slide the iron back and forth on the specimen, but simply press it down in a manner simulating the action of a flat-bed press.

7.4.4 After hand ironing or pressing, pre-condition (see 6.1.3) and then condition specimens for at least 4 h by laying each specimen separately on the screen or perforated shelf of a conditioning rack in an atmosphere at 21 ± 1°C (70 ± 2°F) and 65 ± 2% RH.

8. Measurement and Evaluation

8.1 After conditioning, lay each test specimen without tension on a smooth, horizontal surface and determine dimensional change by one of the following options:

Option 1: Measure and record the distance between each pair of bench marks to the nearest millimeter, 0.1 in. or smaller increment. This is Measurement "B."

Option 2: If using a scale marked in percent dimensional change, measure to nearest 0.5% or smaller increment and record the percent dimensional change directly.

8.2 The wrinkles in most fabrics flatten sufficiently under pressure of the measuring instrument at the time of measurement not to cause measurement bias.

9. Calculations

9.1 Using Distance Measurements.

9.1.1 Calculate the dimensional change after the first and fifth cycle for each specimen to the nearest 0.1%, using the following equation, or other specified number of washing and drying cycles, as follows (see 12.10):

$$\% \text{ Dimensional Change} = (B - A) \times 100/A$$

where:

A = the average of the three original measurements for the lengthwise or widthwise direction in the specimen.

B = the average of the three measurements after cycle completed for the lengthwise or widthwise direction of the specimen.

9.1.2 Calculate the average lengthwise and widthwise percent dimensional change for all specimens.

9.2 Using Dimensional Change Scale.

9.2.1 Average the scale measurements for each direction of each specimen to the nearest 0.1%.

9.2.2 Average the scale measurements for each direction of all specimens.

10. Report

10.1 Report for each sample tested:

10.1.1 Dimensional change of both length and width, separately (see 9.1.2).

10.1.2 Washing procedure (Roman numeral), drying procedure (capital letter) and restoration procedure (Arabic numeral) from Table I; i.e., I,E,I means Wash Procedure I, Flatbed press dry, and tension presser restoration. Indicate size of load; i.e., 1.8 kg.

10.1.3 Number of complete washing and drying cycles.

10.1.4 If fabrics are visibly distorted in unlaundered state.

10.1.5 Restoration procedure, if any.

10.1.6 Alternate size specimens and bench marks, if used.

10.1.7 The detergent used.

10.1.8 Any modification to the test.

11. Precision and Bias

11.1 *Precision.*

11.2 Single-Laboratory Study. Six woven fabrics were tested in one laboratory, using one operator to determine dimensional stability on three different specimens by using Test VIc, Tumble Dry. Three specimens were taken from each fabric sample and three measurements were made in each specimen in both the warp and filling directions. This single-laboratory data set was analyzed and used in writing a temporary precision statement, pending a full interlaboratory study. Until the full study is completed, users of the test method are advised to exercise conventional statistical caution in making any comparisons of test results. The variances for the warp and filling directions were analyzed as follows:

11.2.1 *Warp.* Variances for the warp direction ranged in value from 0.012 to 0.048, with an average value of 0.027% (standard deviation = 0.165%), as determined by analysis of variance.

11.2.2 *Filling.* Variances for the filling direction ranged in value from 0.0025 to 0.0800, with an average value of 0.0203% (standard deviation = 0.143%), as determined by analysis of variance.

Two averages of obtained values should be considered significantly different at the 95% probability level if the differences equals or exceeds the critical differences listed in Tables III and IV.

11.3 *Bias.* The values derived by this procedure can be defined only in terms of a test method. There is no independent, referee

**Table III—Within-Laboratory Critical Differences
% Shrinkage—95% Probability Level**

N	SE	CD
1	0.165	0.462
3	0.095	0.266
5	0.074	0.207
7	0.062	0.174

N = Number of determinations per average
SE = Standard Error for N determinations
CD = 2.8 SE

**Table IV—Within-Laboratory Critical Differences
% Shrinkage—95% Probability Level**

N	SE	CD
1	0.143	0.399
3	0.082	0.230
5	0.064	0.178
7	0.054	0.150

test method by which bias may be determined. This test method has no known bias.

12. Notes

12.1 The wheel (cage) is 56 ± 5 cm inside diameter and 56 ± 5 cm inside length. There are three fins, each approximately 7.5 cm high, extending the full length of the inside of the wheel. A fin is located every 120° around the inside diameter of the wheel. The wash wheel rotates at a speed of 30 ± 5 rpm, making 5-10 revolutions before reversing. The water inlets are large enough to permit filling the wheel to 0.3 cm level in less than 2 min and the outlet is large enough to permit discharge of the same amount of water in less than 2 min. The machine is equipped with a pipe, for injecting live steam, that is capable of raising the temperature of water at a 19.3 cm level from 38-60°C in less than 2 min. The machine shall contain an opening for the insertion of a thermometer or other equivalent equipment for determining the temperature of the water during the washing and rinsing procedures. It is equipped with an outside water gauge that will indicate the level of the water in the wheel. A washing machine of this type, such as Model 2420D, is available from Powercom Corp., 5 Sage Hill Ln., Troy NY 12180; tel: 518/273-3011.

12.2 Pressing equipment of the type described may be obtained from Hoffman New Yorker, 25 McLean Blvd., Paterson NJ 07514. New Yorker Flatbed Press Model ES 24 X 48 or Model ES 24 X 60.

12.3 Screen or perforated conditioning/drying racks are available from Somers Sheet Metal Inc., 5590 N. Church St., Greensboro NC 27405; tel: 336/643-3477; fax: 336-643-7443. Rack drawings are available from AATCC, P.O. Box 12215, Research Triangle Park NC 27709; tel: 919/549-8141; fax: 919/549-8933; e-mail: orders@aatcc.org.

12.4 An extracting machine (Model 305-TX) is available from Bock Laundry Machine Co., 3600 Summit St., Toledo OH 43611; tel: 419/726-2645.

12.5 Marking pens with different size tips are available from Mark-Tex Corp., P.O. Box 681, Englewood NJ 07631; tel: 201/567-4111; and AATCC, P.O. Box 12215, Research Tri-

angle Park NC 27709; tel: 919/549-8141; fax: 919/549-8933; e-mail: orders@aatcc.org.

12.6 A ruled template marked in percent dimensional change is available from AATCC, P.O. Box 12215, Research Triangle Park NC 27709; tel: 919/549-8141; fax: 919/549-8933; e-mail: orders@aatcc.org. A mechanical marking device and measuring tape marked in percent dimensional change is available from Benchmark Devices Inc., 3305 Equestrian Trail, Marietta GA 30064; tel: 770/795-0042; fax: 770/421-8401; e-mail: bmarkers@bellsouth.net.

12.7 Alkylarylsulfonate synthetic detergents are available under varying trade names from most suppliers of detergents. The 1993 AATCC Standard Reference Detergent is available from AATCC, P.O. Box 12215, Research Triangle Park NC 27709; tel: 919/549-8141; fax: 919/549-8933; e-mail: orders@aatcc.org.

12.8 Dimensional change results obtained with the 50 cm bench marks may not be equal to those obtained with 25 cm bench marks.

12.9 An alternative drying procedure, *not to be used for referee tests*, is as follows: remove the specimens from the wash wheel and squeeze out the excess water by hand, without wringing, twisting or passing through squeeze rolls. Spread each specimen on a horizontal screen or perforated surface, removing wrinkles but not distorting or stretching and allow to dry in still air at room temperature. Dampen the specimen with water, allow to stand for 5 min, then press dry on the flatbed press as directed in 7.3.6.

12.10 If information on the dimensional change variability within or between specimens is needed, calculate dimensional change based on the individual pairs of bench marks for within specimen data or based on the average of the three pairs of bench marks for between specimen data.

12.11 *ASTM D 6193, Standard Practice for Stitches and Seams*, available from ASTM, 100 Barr Harbor Dr., West Conshohocken PA 19428-2959; tel: 610/832-9585; fax: 610/832-9555.

12.12 Ballast are available from Testfabrics Inc., P.O. Box 26, West Pittston PA 18643; tel: 570/603-0432; fax: 570/603-0433; e-mail: testfabric@aol.com; and Textile Innovators Corp., div. of SDL Atlas L.L.C., P.O. Box 8, 101 Forest St., Windsor NC; tel: 252/794-9703; fax: 252/794-9704; e-mail: tic@sdatlas.com.

12.13 The AATCC Technical Center conducted a study to compare the 1993 AATCC Standard Reference Detergent 124 and two different types of ballast fabrics (current and proposed), under the following test conditions:

Machine cycle: (1)—Normal/Cotton Sturdy
Washing Temp: (V)— $60 \pm 3^\circ\text{C}$
Drying Procedure: (A)i—Tumble dry, cotton sturdy cycle
Fabrics tested: White Twill (100% cotton)
Beige Twill (100% cotton)
Grey Poplin (100% cotton)
Blue Twill (50/50 poly/cotton)

No significant differences were found in the results using either detergent or ballast load fabrics.

12.14 A digital imaging system may be used as a measuring device in place of the prescribed manual measurement devices if it is established that its accuracy is equivalent to the manual devices.

Extractable Content of Greige and/or Prepared Textiles

Developed in 1960 by AATCC Committee RA34; reaffirmed 1968, 1972, 1975, 1988, 1989; revised 1978, 1982 (with title change), 1995, 1999; editorially revised 1987, 1993.

1. Purpose and Scope

1.1 This test method is intended for determining the amount of water, enzyme and organic-solvent extractable materials in yarn or fabric containing cellulosic fibers or blends thereof.

2. Principle

2.1 Water and enzyme soluble materials are removed from a test specimen in order by treatments in (1) hot water, and (2) an amylase solution. Oils, fats and waxes are removed by extraction with 1,1,1-trichloroethane.

3. Terminology

3.1 **extractable matter**, n.—nonfibrous material in or on a textile substrate, not including water, which is removable by a specified solvent or solvents as directed in a specified procedure.

4. Safety Precautions

NOTE: These safety precautions are for information purposes only. The precautions are ancillary to the testing procedures and are not intended to be all inclusive. It is the user's responsibility to use safe and proper techniques in handling materials in this test method. Manufacturers MUST be consulted for specific details such as material safety data sheets and other manufacturer's recommendations. All OSHA standards and rules must also be consulted and followed.

4.1 Good laboratory practices should be followed. Wear safety glasses in all laboratory areas.

4.2 All chemicals should be handled with care.

4.3 1,1,1-Trichloroethane can be irritating to the eyes and mucous membranes. It should only be handled in an adequately ventilated laboratory hood.

4.4 An eyewash/safety shower should be located nearby and an organic vapor respirator should be readily available for emergency use.

4.5 Exposure to chemicals used in this procedure must be controlled at or below

levels set by governmental authorities (e.g., Occupational Safety and Health Administration's [OSHA] permissible exposure limits [PEL] as found in 29 CFR 1910.1000 of January 1, 1989). In addition, the American Conference of Governmental Industrial Hygienists (ACGIH) Threshold Limit Values (TLVs) comprised of time weighted averages (TLV-TWA), short term exposure limits (TLV-STEL) and ceiling limits (TLV-C) are recommended as a general guide for air contaminant exposure which should be met (see 10.3).

5. Apparatus

5.1 Analytical balance with a sensitivity of 0.01 g.

5.2 Circulating air oven capable of maintaining 105-110°C (220-230°F).

5.3 Soxhlet extraction assembly.

5.4 Weighing bottles with glass covers.

5.5 Beakers, 300 mL, tall-form.

5.6 Sieve, stainless steel, 100-mesh.

5.7 Calcium chloride (CaCl₂) or equivalent desiccant.

5.8 1,1,1-Trichloroethane, (methylchloroform), extraction grade.

5.9 Bacterial amylase, *bacillus subtilis* origin, 1600-1800 B.A.U. (see AATCC Method 103).

6. Specimens

6.1 Take an approximately 10 g specimen from each sample to be analyzed. If the material is a woven fabric, it should be cut on the bias and the edges should be folded inside the specimen to avoid loss of loose fibers or yarns.

7. Procedure

7.1 **Drying Specimen.** Place the specimen in a tared weighing bottle, dry it to constant weight in the oven at 105-110°C (220-230°F), cool it in the desiccator and weigh the bottle and specimen to the nearest 0.01 g (see AATCC Method 20A, 8.1) (see 10.1 and 10.2).

7.2 **Water Soluble Materials.** Remove the dried specimen from the bottle and place it in a beaker containing 200 mL of distilled water at 82 ± 3°C (180 ± 5°F). Maintain the temperature of the water at 82 ± 3°C (180 ± 5°F) for 2 h. Then pour the water and specimen into a Buchner funnel secured in a filtration flask. Wash the specimen with two 25 mL portions of distilled water and partially dry the speci-

men by squeezing on the funnel. Return the specimen to its bottle and oven dry, cool and reweigh it. Determine the amount of water extractable matter as the difference in the specimen weights obtained in 7.1 and 7.2.

7.3 **Enzyme Extractable Material.** Remove the specimen (see 7.2) from the bottle and place it in a beaker containing 200 mL of a 2% bacterial amylase solution. Hold the solution at 74 ± 3°C (165 ± 5°F) for 1 h. Pour the solution and specimen into the sieve and rinse the specimen free of enzyme by washing with 10 successive 100 mL portions of distilled water at 82 ± 3°C (180 ± 5°F). Oven dry, cool and reweigh the specimen in the bottle. Determine the amount of enzyme extractable matter as the difference in the weights obtained in 7.2 and 7.3.

7.4 **Oils, Fats and Waxes.** Place the dried specimen (see 7.3) in a fresh thimble in the Soxhlet extractor and extract 12-16 times with 1,1,1-trichloroethane. Remove the thimble from the extractor and evaporate the major portion of the 1,1,1-trichloroethane remaining on the specimen in a hood. Remove the specimen from the thimble and return it to the bottle. Oven dry, cool and reweigh the specimen and bottle. Determine the amount of solvent extracted material as the difference in the specimen weights obtained in 7.3 and 7.4.

8. Calculations

8.1 Calculate the material extracted from each specimen by water, enzyme and solvent, to the nearest 0.1%, using the following equation:

$$E = [(B-A)/I] (100)$$

where:

E = the material extracted by water, enzyme solution or organic solvent, %,

B = the mass of the specimen before the particular extraction, g,

A = the mass of the specimen after the particular extraction, g, and

I = the mass of the oven-dried specimen before the first extraction, g.

8.1.1 If the extractable material for any of the three extractions is less than 0.2%, record the value for that extraction as "less than 0.2%."

8.2 Determine the total extractables for each sample as the sum of the three extractables for that sample. Those values

reported as “less than 0.2%” are arbitrarily added in as 0.1%.

9. Precision and Bias

9.1 Interlaboratory Study. A limited study of the test method was performed in 1996, with three participating laboratories, using two testing operators in each, and two specimens per operator. Six fabrics ranging from 0.4%-9.5% total extractables by weight were included in the study. This is the best and only data set derived to date for determining precision of the test method. Users of the test method should take this limited basis into account in making any critical comparisons.

9.2 Precision. Residual variances of the fabrics were found to be uniform and were grouped by the analysis program into a single category, allowing use of a single critical difference table (see 9.2.2) for all fabrics in the study. When comparing two averages of the same fabric, under any of the three precisions stated, a difference equal to, or greater than, the table value is considered to be statistically significant on a probability of 95%.

9.2.1 Components of Variance. Six components of variance computed by the analysis program are shown both as vari-

Table I—Components of Variance

Component	Symbol	Variance	sd
Fabric	V(F)	12.2021	3.493
Laboratory	V(L)	0.0236	0.154
FxL Interaction	V(FL)	0	-
Operator	V(O.L)	0.0077	0.088
(within labs)			
FxO(L) Interaction	V(FO.L)	0.0112	0.106
Residual	V	0.0305	0.175

ances and as standard deviations (see Table I).

The unit for standard deviation is percent (by weight). The unit for variance is the square of percent (by weight).

9.2.2 Critical Differences. Precision for this test method is stated as critical differences (see Table II).

Since comparisons involving multiple fabrics are not usually made, these critical differences are not included. The values in Table I may be used to calculate these differences, if needed.

9.3 Bias. Extractable content of greige textiles, or of prepared textiles, can be defined only in terms of a test method. There is no independent referee method that derives a value by which bias may be determined. As a means of estimating extractable content of textiles, this test method has no known bias.

Table II—Critical Differences for Two Averages for the Conditions Noted, 95% Probability Level, % Total Extracted

Number of Test Results in Each Average	Single-Fabric Comparisons		
	Single-Operator Precision	Within-Laboratory Precision	Between-Laboratory Precision
1	0.48	0.54	0.69
2	0.34	0.42	0.60
4	0.24	0.34	0.55
8	0.17	0.30	0.52

10. Notes

10.1 It has been found that with constant atmospheric conditions, this weight is reproducible to the nearest milligram. However, normal humidity variations will cause differences of as much as 0.01 g for a specimen which is dried and weighed and redried in the oven without any other treatment. This factor is the limit to the accuracy of the following steps.

10.2 Synthetic fibers sensitive to drying conditions in 7.1 will not yield accurate data by this test method.

10.3 Available from Publications Office, ACGIH, Kemper Woods Center, 1330 Kemper Meadow Dr., Cincinnati OH 45240; tel: 513/742-2020.

Alkali in Bleach Baths Containing Hydrogen Peroxide

Developed in 1960 by AATCC Committee RA34; reaffirmed 1968, 1972, 1975, 1979, 1988, 1989, 2002; revised 1982 (with title change), 1997; editorially revised 1984, 1985, 1987.

1. Purpose and Scope

1.1 This test method determines the total alkali content of a bleach bath containing hydrogen peroxide and alkali from any source. The total alkali content is expressed as % sodium hydroxide.

1.2 Alkali in bleach baths may be supplied by sodium hydroxide, sodium silicate, sodium carbonate or by various other alkaline materials, including potassium compounds, ammonia, lime or by peroxygen solids which contain alkaline salts.

1.3 The alkali content of a bleach bath is a critical parameter in determining the rate and extent of bleaching and may also determine the extent to which the textile being bleached is affected by the bleaching process.

1.4 This test method is used for laboratory determinations and for process control.

2. Principle

2.1 A weighed specimen of the bleach bath is titrated with a standardized solution of sulfuric acid to a Phenol Red end-point, or to the pH range 6.8-8.4 on a pH meter. The total alkali, expressed as % NaOH, is calculated based on the weight of the bath.

3. Terminology

3.1 **bleaching**, n.—elimination of unwanted coloring matter from a substrate by oxidative or reductive chemical treatment.

4. Safety Precautions

NOTE: These safety precautions are for information purposes only. The safety precautions are ancillary to the testing procedures and are not intended to be all inclusive. It is the user's responsibility to use safe and proper techniques in handling materials in this test method. Manufacturers MUST be consulted for specific details such as material safety data sheets and other manufacturer's recommendations. All OSHA standards and rules must also be consulted and followed.

4.1 Good laboratory practices should

be followed. Wear safety glasses in all laboratory areas.

4.2 All chemicals should be handled with care. Sulfuric acid is corrosive. When preparing the dilute solutions from pure or concentrated reagents, use chemical goggles or face shield, impervious gloves, and an impervious apron. CAUTION: Always add acid to water.

4.3 An eyewash/safety shower should be located nearby and a high efficiency particulate respirator with organic vapor cartridge and full facepiece should be readily available for emergency use.

4.4 Exposure to chemicals used in this procedure must be controlled at or below levels set by governmental authorities (e.g., Occupational Safety and Health Administration's [OSHA] permissible exposure limits [PEL] as found in 29 CFR 1910.1000 of January 1, 1989). In addition, the American Conference of Governmental Industrial Hygienists (ACGIH) Threshold Limit Values (TLVs) comprised of time weighted averages (TLV-TWA), short term exposure limits (TLV-STEL) and ceiling limits (TLV-C) are recommended as a general guide for air contaminant exposure which should be met (see 10.1).

5. Apparatus and Materials

5.1 Potassium acid phthalate ($C_8H_5O_4K$), ACS Reagent.

5.2 Phenol Red (phenol-sulfonphthalein), or 0.06% solution thereof, if a pH meter is not used as an alternative.

5.3 Methanol (CH_3OH) (not needed if 0.06% Phenol Red solution is available).

5.4 Sulfuric acid (0.1N) (H_2SO_4), ACS Reagent, 95-98%, or 0.1N (see 6.1 and 10.2).

5.5 Sodium hydroxide (NaOH), ACS Reagent.

6. Preparation of Reagents

6.1 Preparation and standardization of 0.1N H_2SO_4 (see 10.2).

6.1.1 For each liter of 0.1N H_2SO_4 solution to be prepared, weigh 5.5 ± 0.001 g C.P. sulfuric acid and add it to 500 ± 100 mL deionized water with stirring. CAUTION: *Dilution of sulfuric acid is exothermic. Use appropriate safety precautions.* Cover the solution and allow it to cool to $20 \pm 1^\circ C$. Add the solution to a 1 L volumetric flask, and dilute to mark with deionized water.

6.1.2 Weigh 4.0 ± 0.01 g sodium hydroxide and dissolve it in about 100 mL deionized water in a 250 mL beaker.

Transfer the solution to a 1 L volumetric flask, and rinse the beaker 5 times with deionized water, adding the rinses to the volumetric flask. Then dilute to mark with deionized water.

6.1.3 Weigh 20.4080 ± 0.0002 g potassium acid phthalate (National Bureau of Standards sample No. 84) and dissolve it in approximately 100 mL deionized water in a 250 mL beaker. Transfer the solution to a 1 L volumetric flask, and rinse the beaker 5 times with deionized water, adding the rinses to the volumetric flask. Dilute to mark with deionized water.

6.1.4 Using a volumetric pipette, transfer 25 mL of the potassium acid phthalate solution into a 250 mL Erlenmeyer flask. Add 5 drops of 0.06% Phenol Red indicator solution, and titrate with the sodium hydroxide solution to a greenish-yellow end-point, or to pH 7.6 ± 0.8 if using a pH meter to detect the end-point.

6.1.5 Calculate the normality of the sodium hydroxide solution (N_h) to the nearest 0.001 by the following equation:

$$N_h = \frac{(25)(0.1000)}{mL}$$

where:

mL = the number of mL of sodium hydroxide solution required.

6.1.6 Using a volumetric pipette, transfer 25 mL of the sulfuric acid solution (see 8.1) into a 250 mL Erlenmeyer flask. Add 5 drops of 0.06% Phenol Red indicator solution and titrate with the sodium hydroxide solution to a greenish-yellow end-point, or to pH 7.6 ± 0.8 if using a pH meter to detect the end-point.

6.1.7 Calculate the normality of the sulfuric acid solution to the nearest 0.001 by the following equation:

$$N_s = \frac{(mL)(N_h)}{(25)}$$

where:

N_s = normality of the sulfuric acid solution

mL = number of mL of sodium hydroxide solution

N_h = normality of the sodium hydroxide solution

6.1.8 Adjustment of normality of sulfuric acid solution.

6.1.8.1 If the normality of the sulfuric acid solution is less than 0.0990, discard it and make up a new solution.

6.1.8.2 If the normality of the sulfuric acid solution is greater than 0.1010, ad-

just it by adding an amount of water calculated using the following equation:

$$\text{mL H}_2\text{O} = \frac{(N)(950)}{0.1000} - 950$$

where:

N = the normality of the sulfuric acid solution

950 = mL sulfuric acid solution after removal of two samples for titration.

6.1.8.3 Re-standardize the adjusted sulfuric acid solution using 6.1.6 and 6.1.7.

6.2 If the indicator solution is prepared in-lab, preparation of 0.06% Phenol Red indicator solution (see 10.2).

6.2.1 Weigh 1.0 ± 0.1 g Phenol Red and dissolve it in 833 mL methanol.

6.2.2 Add 833 mL deionized water.

6.2.3 Cover the solution and stir with a magnetic stirrer until the solution is completely clear.

7. Procedure

7.1 Measure 20 ± 1 mL deionized water into a 250 mL beaker, and add 2-3 drops of Phenol Red indicator solution. If a pH meter is used to detect the end-point, do not add Phenol Red indicator solution.

7.2 Weigh a 10 ± 0.01 g specimen from the bleach bath. Add the specimen to the beaker and mix (see 10.3).

7.3 Titrate the contents of the beaker with 0.1*N* sulfuric acid to a greenish-yellow end-point, or to pH 7.6 ± 0.8 if using a pH meter to detect the end-point.

7.4 Record the number of the 0.1*N* sulfuric acid used to the nearest 0.1 mL.

8. Calculations

8.1 Calculate the total alkali as NaOH to the nearest 0.1% using the following equation:

% Total Alkali, as NaOH

$$= \frac{(\text{mL})(N)(0.040)(100)}{W}$$

where:

mL = the number of mL of the sulfuric acid solution required, as recorded in 6.4.

N = the normality of the sulfuric acid solution, as determined in 8.7.

0.040 = the milliequivalent weight of sodium hydroxide.

W = the mass of the specimen, as determined in 6.2.

8.2 For alternative calculations see 10.4.

9. Precision and Bias

9.1 Precision.

9.1.1 In 1995 an interlaboratory study included five laboratories with two operators each, evaluating three concentrations of alkali in aqueous solutions containing 1.15% hydrogen peroxide (H_2O_2). Each operator made three determinations on each concentration. Data were analyzed using the ASTM Tex-pac program (see 10.5).

9.1.2 Analysis showed the residual variances of the three concentrations could be pooled as shown in Table I.

Table I—Critical Differences for Two Averages for the Conditions Noted, 95% Probability Level, % Alkali Concentration

Number of Test Results in Each Average	Single-Material Comparisons		
	Single-Operator Precision	Within-Laboratory Precision	Between-Laboratory Precision
1	0.013	0.027	0.069
2	0.009	0.025	0.069
3	0.008	0.025	0.068
4	0.007	0.025	0.068

9.2 Bias.

9.2.1 The results obtained in the interlaboratory study indicate 97.6% average recovery as compared with the calculated values of alkali concentration based on chemical additions. However, the concentration of alkali can be defined only in terms of a test method, and within this limitation this method has no known bias in the determination of alkali concentration.

10. Notes

10.1 Available from Publications Office, ACGIH, Kemper Woods Center, 1330 Kemper Meadow Dr., Cincinnati OH 45240; tel: 513/742-2020

10.2 Standardized solutions of sulfuric acid, sodium hydroxide, and Phenol Red indicator are available from various laboratory supply companies in either prepared solution or as concentrates. Standardization of purchased reagent solutions should be verified by the procedures in 6.1.4-6.1.7.

10.3 For process control purposes, specimen volume is often substituted for weight. In this case the % alkali may be in error to the extent of the bleach bath density. If results are to be communicated between installations, specimen mass should be used.

10.4 Simplifications and conversions.

10.4.1 If 0.1*N* H_2SO_4 solution is used, and the specimen mass is 10.0 g, the equation in 8.1 is simplified to:

$$\% \text{ alkali as NaOH} = (0.04) (\text{mL})$$

10.4.2 Alkalinity may be defined in terms other than "% as NaOH." Some convenient alternatives, using 0.1*N* sulfuric acid solution, a specimen mass of 10.0 g, and the term "mL" as defined in 8.1, are:

(mL) (2.5) = lb sodium silicate per 100 gal, if the sodium silicate is 10.5% Na_2O

(mL) (2.9) = lb sodium silicate per 100 gal, if the sodium silicate is 8.9% Na_2O

(mL) (0.332) = lb NaOH per 100 gal

10.5 Available from ASTM, 100 Barr Harbor Dr., West Conshohocken PA 19428; tel: 610/832-9500; fax: 610/832-9555.

Dimensional Changes of Woven or Knitted Wool Textiles: Relaxation, Consolidation and Felting

Developed in 1960 by AATCC Committee RA42; revised 1962, 1988 (with title change), 2004; reaffirmed 1972, 1975, 2000; editorially revised 1974, 1982, 1984, 1989, 1990, 1991, 1994; editorially revised and reaffirmed 1983, 1993.

1. Purpose and Scope

1.1 This method is an accelerated test for determination of relaxation, consolidation and felting shrinkage of woven and knitted textiles containing 50% or more wool.

1.2 The overall dimensional change in a fabric during home laundering is a significant performance factor to the ultimate consumer of a garment. However, further analysis of the components of dimensional change is invaluable to a fabric manufacturer, since it allows the fabric manufacturer to make appropriate changes in the design and processing of fabrics to reduce their tendency to change dimensionally when washed.

2. Principle

2.1 Relaxation dimensional change is determined by soaking marked and measured specimens in water containing a wetting agent, hydro-extracting, drying and remeasuring.

2.2 Consolidation dimensional change is determined, after testing for relaxation dimensional change, by immersing the measured specimens in a buffer solution, agitating for a short time period, rinsing, hydro-extracting, drying and remeasuring.

2.3 Felting dimensional change is determined, after testing for consolidation dimensional change, by washing the measured specimens in a solution of soap, polyphosphate and borax, or a solution of soap, polyphosphate and sesquicarbonate in a washer, rinsing, hydro-extracting, drying and measuring.

3. Terminology

3.1 **consolidation dimensional change**, n.—the dimensional change that occurs when a fabric is gently agitated in water to overcome all the frictional constraints in it after it has been allowed to relax in water without agitation.

3.2 **dimensional change**, n.—a generic term for changes in length or width of a fabric specimen subjected to speci-

fied conditions. The change is usually expressed as a percentage of the initial dimension of the specimen.

3.3 **felting dimensional change**, n.—the irreversible dimensional change that occurs in a consolidated wool fabric when it is subjected to agitation in laundering.

3.4 **frictional constraint**, n.—in *textile wet processing*, the resistance to fiber movement imposed by fiber to fiber contacts within a fabric.

3.5 **growth**, n.—a dimensional change resulting in an increase in the length or width of a specimen.

3.6 **laundering**, n.—of *textile materials*, a process intended to remove soils and/or stains by treatment (washing) with an aqueous detergent solution and normally including rinsing, extraction and drying.

3.7 **relaxation dimensional change**, n.—the dimensional change that occurs when a fabric is immersed in water without agitation so that the strains and stresses put into fibers, yarns, or fabrics during previous processing stages such as spinning, weaving or knitting and finishing are relieved.

3.8 **shrinkage**, n.—a dimensional change resulting in a decrease in the length or width of a specimen.

3.9 **wool**, n.—used in the generic sense, fiber from the fleece of the sheep or lamb, hair from the Angora or Cashmere goat, rabbit hair and the so-called specialty hair fibers from the camel, alpaca, llama and vicuna.

4. Safety Precautions

NOTE: These safety precautions are for information only. The precautions are ancillary to the testing procedures and are not intended to be all inclusive. It is the user's responsibility to use safe and proper techniques in handling materials in this test method. Manufacturers MUST be consulted for specific details such as material safety data sheets and other manufacturer's recommendations. All OSHA standards and rules must also be consulted and followed.

4.1 Good laboratory practices should be followed. Wear safety glasses in all laboratory areas.

4.2 Manufacturer's safety recommendations should be followed when operating laboratory testing equipment.

5. Apparatus and Materials

5.1 Apparatus.

5.1.1 Automatic washing machines (see 18.1).

5.1.2 Washing machine, cylindrical wash wheel of the reversing type (see 18.2).

5.1.3 Hydro-extractor—Centrifugal extractor of the laundry type with a perforated basket approximately 29.0 cm (11.5 in.) deep × 51 cm (20 in.) in diameter, with an operating speed of approximately 1700 rpm (see 18.3).

5.1.4 Tray, 76 × 61 × 15 cm (30 × 24 × 6 in.), or a suitable substitute.

5.1.5 Indelible ink marking pen (see 18.4) for use with suitable rule, tape, marking template or other marking device (see 18.5).

5.1.6 Conditioning/drying racks with pull-out screen or perforated shelves (see 18.6).

5.1.7 Laboratory forced air oven (see 18.7).

5.2 Measuring Devices.

5.2.1 Tape or rule marked in millimeters, tenths of an inch or smaller increment.

5.2.2 Tape or template with rule marked directly in percent dimensional change to 0.5% or smaller increment (see 18.5).

5.2.3 Schiefer sock-measuring machine (see 18.8).

5.2.4 Digital Imaging System (see 18.9).

5.3 Materials.

5.3.1 Sulfated fatty alcohols or wetting agent.

5.3.2 Phosphate buffer (pH 7)—A solution containing 5.9 g (0.21 oz) of sodium dihydrogen orthophosphate (anhydrous) and 8.0 g (0.28 oz) of disodium hydrogen orthophosphate (anhydrous) per 1000 mL (0.26 gal) of water. Distilled water is not essential but water having a hardness greater than 100 ppm (calculated as calcium carbonate) should not be used.

5.3.3 Soap, neutral chip (see 18.10).

5.3.4 Polyphosphate, sodium (see 18.11).

5.3.5 Ballast of 4.3 × 4.3 cm (1.0 × 1.0 in.) made of 18.25 tex continuous filament polyester, 2.2 mm (0.09 in.) stitch loop length plain knit (see 18.12). Each piece should weigh approximately 40 g (1.4 oz). The ballast should have rounded corners, have no loose ends, and must not unravel during the test. Alternate size ballast may be necessary to

achieve accurate load weight. Before use, ballast must be adjusted to pH 7 by soaking them in the buffer solution specified in 5.3.2.

5.3.6 Nonionic detergent. A synthetic detergent of the ethylene oxide alkyl phenol condensate type (see 18.13).

6. Test Specimens

6.1 Sampling and Preparation.

6.1.1 The preparation of test specimens will vary depending upon the type of fabric being tested.

6.1.2 Three specimens of each sample to be tested are required to increase the precision of the average.

6.1.3 Where possible, each specimen should contain different groups of lengthwise and widthwise yarns.

6.1.4 Fabrics that are badly distorted in their unlaundered state due to faulty finishing or other causes may give deceptive dimensional change results when laundered by any procedure. Therefore, it is recommended that in such cases the specimens be replaced or, if used, the results of the dimensional change test be considered as indicative only. Fabric condition should be reported.

6.1.5 Prior to marking, pre-condition and condition test specimens as directed in ASTM D 1776, Standard Practice for Conditioning and Testing Textiles. Condition each specimen for at least 4 h in an atmosphere of $21 \pm 1^\circ\text{C}$ ($70 \pm 2^\circ\text{F}$) and $65 \pm 2\%$ RH by laying each test specimen separately on a screen or perforated shelf of a conditioning rack.

6.2 Marking.

6.2.1 Woven and warp knit fabrics: Take each 38×38 cm (15×15 in.) test specimens and mark with three 25 cm (10 in.) pairs of bench marks parallel to the length of the fabric, and three 25 cm (10 in.) pairs of bench marks parallel to the width of the fabric. Each bench mark must be at least 5 cm (2 in.) from all edges of the test specimen. Pairs of bench marks in the same direction must be approximately 12 cm (5 in.) apart. Any alternate size specimen and bench marks used must be indicated in the report. Marks of 50 cm and 18 in. are commonly used to give better precision (see 18.14). Sewing thread can be used to make bench marks.

6.2.2 Flat and circular knit fabrics: Tubular finished knit fabric samples representing goods used in the tubular state; i.e., underwear, sweat shirts, polo shirts, etc., to be tested in the tubular state. Tubular finished knit fabric samples representing goods used in the slit open width state; i.e., dresses, slacks, suits, etc., are to be slit and handled flat. Mark specimens as in 6.2.1. For fabrics which will run or ladder, it is suggested that the edges be sewn with stitch type 505 (see 18.15).

6.3 Original Measurement.

6.3.1 To improve the accuracy and precision of the dimensional change calculations based on the bench marks applied to the fabrics in 6.2, measure and record the distance between each pair of bench marks with suitable tape or rule to the nearest millimeter, 0.1 in. or smaller increment. This is Measurement A.

6.3.2 Hosiery. The specimen is one sock. Make the original footlength measurement on a Schiefer Sock-Measuring Device. Place the conditioned sock over the metal form, align the heel gore by moving the pivoting clamp to the position by the limiting stop and tighten the clamp. Align the toe gore with the center of the toe form and draw the sock back smoothly. Press the pin on the indicator through the sock and the small hole in the top of the toe form and slowly apply the force of the weight to the sock. Using a tension of 2.268 kg (5.0 lb), read the footlength to the nearest 0.1 in. directly from the pin indicator against the scale. This is Measurement A.

7. Test Procedure: Relaxation Dimensional Change

7.1 Wetting Out. Half fill the tray with 0.1% solution of sulfated fatty alcohols (or other wetting agent) in water at $38 \pm 3^\circ\text{C}$ ($100 \pm 5^\circ\text{F}$). Submerge the marked specimens in the tray and allow them to soak for 4 h or overnight. The water temperature may be allowed to come to room temperature during the soaking period.

7.2 Hydro-extraction. With as little distortion as possible, remove the wet specimens from the tray in ball form and hydro-extract for 10 s at full speed.

7.3 Drying. Lay specimens flat, without blocking or distortion, on a drying rack. Allow specimen to dry in still air at room temperature or dry in an oven at $60 \pm 5^\circ\text{C}$ ($140 \pm 9^\circ\text{F}$). Do not press the specimens dry.

7.4 After drying, condition the specimens for at least 4 h by laying each specimen separately on the screen or perforated shelf of a conditioning rack at $21 \pm 1^\circ\text{C}$ ($70 \pm 2^\circ\text{F}$) and $65 \pm 2\%$ RH.

8. Measurement

8.1 Woven and knitted fabrics. After conditioning lay each test specimen without tension on a flat smooth, horizontal surface. Measure and record the distance between each pair of bench marks to the nearest millimeter, 0.1 in. or smaller increment. This is Measurement R. If using a scale marked in percent dimensional change, measure to nearest 0.5% or smaller and record the percent dimensional change directly.

8.2 Socks. Load and record specimen on the Schiefer Sock-Measuring Device as directed in 6.3.2.

9. Calculation

9.1 If measurements were made directly in percent relaxation dimensional change, average the measurements in each direction made for the three specimens. Calculate length and width averages separately to the nearest 0.1%.

9.2 If measurements were made to the nearest millimeter, 0.1 inch or smaller, calculate the percent relaxation dimensional change as follows:

% Relaxation Dimensional Change

$$= (R - A)/A \times 100$$

where:

A = Original dimension

R = Dimension after relaxation

Both original and final measurements are the averages of the measurements in each direction made on the three test specimens. Calculate length and width averages separately to nearest 0.1% (see 18.16).

9.3 A final measurement smaller than the original measurement is a negative dimensional change which is shrinkage. A final measurement larger than the original measurement results in a positive dimensional change which is growth or negative shrinkage.

10. Test Procedure: Consolidation Dimensional Change

10.1 Washing.

10.1.1 After determination of the relaxation dimensional change as described in Sections 7-9, prepare a 25.0 L (6.6 gal) phosphate buffer solution with a pH of 7.0 and containing 0.5% nonionic detergent. Add the solution to the washing machine.

10.1.2 Temperature of the total load at the beginning of the test shall be $40 \pm 3^\circ\text{C}$ ($105 \pm 5^\circ\text{F}$).

10.1.3 Add to the washing machine a load of 1.00 ± 0.02 kg (2.20 ± 0.04 lb) made up of specimens and ballast (see 5.2.5). No more than half of the load should contain specimens. If one specimen weighs more than 500.0 g (1.1 lb), the limitation regarding test load proportion does not apply.

10.1.4 Set the washing machine for a 5 min, delicate wash (see Table II, Test Method 135). Stop the machine after completion of the wash cycle.

10.2 Rinsing.

10.2.1 Remove each test specimen separately by folding the corners of each to the center in such a way that the whole specimen can be supported in the hand.

10.2.2 Rinse each specimen with as little agitation as possible in three successive baths of water at $40 \pm 3^\circ\text{C}$ ($105 \pm 5^\circ\text{F}$). Transfer each specimen from bath to bath giving one gentle squeeze to remove excess water.

10.3 Hydro-extraction.
10.3.1 Fold each specimen as described in 10.2.1 and lay it flat against the side of the hydro-extractor drum to avoid stretching during spinning. Hydro-extract the specimens for 10 s at full speed.

10.4 Drying.

10.4.1 Dry the specimens as described in 7.3.

10.4.2 Condition the specimens as described in 7.4.

11. Measurement

11.1 After conditioning measure the specimens as directed in Section 8.

11.2 This is Measurement C.

12. Calculation

12.1 If measurements were made directly in percent dimensional change after consolidation, average the measurements in each direction made on the three specimens. Calculate length and width average separately to the nearest 0.1%.

12.2 If measurements were made to the nearest millimeter, 0.1 in. or smaller increment, calculate the total percent dimensional change after consolidation as follows:

% Total dimensional change after consolidation

$$= (C - A) / A \times 100$$

where:

A = Original dimension

C = Dimension after consolidation

Both original and final measurements are the averages of the measurements in each direction made on the three test specimens. Calculate length and width averages separately to nearest 0.1% (see 18.15).

12.3 A final measurement smaller than the original measurement results in a negative dimensional change which is shrinkage. A final measurement larger than the original measurement results in a positive dimensional change which is growth or negative shrinkage.

12.4 Calculate percent consolidation dimensional change in each direction by subtracting percent relaxation dimensional change from percent total dimensional change after consolidation.

13. Test Procedure: Felting Dimensional Change

13.1 Washing.

13.1.1 After determining the consolidation dimensional change as described in Sections 10-12, place the specimens and ballast as may be needed to make up the required load in the wash wheel. The specification for water level, load, temperature, and time are in Table I.

Table I—Felting Dimensional Change Washer Conditions

Test	Water Level	Load		Wash		First Rinse		Second Rinse		Total Time ^b
		Material	Weight ^a	Temp	Time ^b	Temp	Time ^b	Temp	Time ^b	
Iw	5.1 cm (2 in.)	Socks	2.3 Kg (5 lb)	60 ± 3°C (140 ± 5°F)	60	49 ± 3°C (120 ± 5°F)	10	38 ± 3°C (100 ± 5°F)	5	75
IAw	5.1 cm (2 in.)	Socks	2.3 Kg (5 lb)	60 ± 3°C (140 ± 5°F)	120	49 ± 3°C (120 ± 5°F)	10	38 ± 3°C (100 ± 5°F)	5	135
IIw	17.8 cm (7 in.)	Fabric	1.4 Kg (3 lb)	38 ± 3°C (100 ± 5°F)	15	38 ± 3°C (100 ± 5°F)	10	38 ± 3°C (100 ± 5°F)	5	30
IIIw	17.8 cm (7 in.)	Fabric	1.4 Kg (3 lb)	38 ± 3°C (100 ± 5°F)	30	38 ± 3°C (100 ± 5°F)	10	38 ± 3°C (100 ± 5°F)	5	45
IVw	17.8 cm (7 in.)	Fabric	1.4 Kg (3 lb)	38 ± 3°C (100 ± 5°F)	75	38 ± 3°C (100 ± 5°F)	10	38 ± 3°C (100 ± 5°F)	5	90

^a Weight Tolerance—Kg (± 0.1) and lbs (± 0.25)

^b Minutes

13.1.2 Test options are to be selected from the list below according to the type of textile items to be washed (see Table I):

a) Socks containing 80% or more of wool—Test No. Iw.

b) Socks containing less than 80% wool—Test No. IAw.

c) Sweaters—Test No. IIw.

d) Knitted underwear and outerwear—Test No. IIIw.

e) Woven Fabric—Test No. IVw.

13.1.3 Add sufficient water at the specified temperature to give the required water level for the sudsing operation. Add 30 mL of a 50% (by weight) solution of polyphosphate, 170 g of borax or sodium sesqui-carbonate and sufficient soap so that a 1 in. head of suds is produced and maintained during the entire wash.

13.1.4 Stop, drain and refill machine between the wash and first rinse and between the first and second rinses. A 18 cm (7 in.) water level should be used for all rinses.

13.2 Hydro-extraction.

13.2.1 After the final rinse, remove the wet specimens in ball form with as little distortion as possible and hydro-extract for 10 s at full speed.

13.3 Drying.

13.3.1 Dry the specimens as directed in 7.3.

13.3.2 Condition the specimens as directed in 7.4.

14. Measurement

14.1 After conditioning measure the specimens as described in Section 8.

14.2 This is Measurement F.

15. Calculation

15.1 If measurements were made directly in percent total dimensional change after felting, average the measurements in each direction made for the three specimens. Calculate length and width averages separately to the nearest 0.1%.

15.2 If measurements were made to the nearest millimeter, 0.1 in. or smaller increment, calculate the total dimensional change after felting as follows:

% Total dimensional change after felting

$$= (F - A) / A \times 100$$

where:

A = Original dimension

F = Dimension after felting

Both original and final measurements are the averages of the measurements in each direction made on the three test specimens. Calculate length and width averages separately to nearest 0.1% (see 18.15).

15.3 A final measurement smaller than the original measurement results in a negative dimensional change which is shrinkage. A final measurement larger than the original measurement results in a positive dimensional change which is growth or negative shrinkage.

15.4 Calculate percent felting dimensional change in each direction by subtracting total dimensional change after consolidation from total dimensional change after felting.

16. Report

16.1 Report for each sample tested:

a) Relaxation dimensional change, consolidation dimensional change and felting dimensional change of both the length and width separately to the nearest 0.1%.

b) For felting dimensional change, specify the washing procedure (Roman numeral) used from Table I.

c) If fabrics are visibly distorted in unlaundered state.

d) Alternate size specimens and bench marks, if used.

17. Precision and Bias

17.1 *Precision.* Precision for this test

method has not been established. Until a precision statement is generated for this test method, use standard statistical techniques in making any comparisons of test results for either *within-laboratory* or *between-laboratory* averages.

17.2 *Bias*. The dimensional changes of woven or knitted wool textiles (relaxation, consolidation and felting) can be defined only in terms of a test method. There is no independent method for determining the true value. As a means of estimating this property, the method has no known bias.

18. Notes

18.1 Each year AATCC specifies one or more Sears Kenmore automatic washer model(s) as the standard machine(s). The model number(s) of the standard machine(s) and the address of the nearest Sears Commercial Sales Department are available from AATCC, P.O. Box 12215, Research Triangle Park NC 27709; tel: 919/549-8141; fax: 919/549-8933; e-mail: orders@aatcc.org. Any other washer which is known to give comparable results can be used. Washing machine conditions given in Table II of AATCC Method 135 represent the actual speeds and times available on the specified model(s). Other washers may vary in one or more of these settings.

18.2 The wheel (cage) is 56 ± 5 cm (22 ± 2 in.) inside diameter and 56 ± 5 cm (22 ± 2 in.) inside length. There are three fins, each approximately 3 in. high, extending the full length of the inside of the wheel. A fin is located every 120° around the inside diameter of the wheel. The wash wheel rotates at a speed of 30 ± 5 revolutions per minute, making 5-10 revolutions before reversing. The water inlets are large enough to permit filling the wheel to

0.125 in. level in less than 2 min and the outlet is large enough to permit discharge of the same amount of water in less than 2 min. The machine is equipped with a pipe, for injecting live steam, that is capable of raising the temperature of water at a 19.3 cm (8.0 in.) level from 38-60°C (100-140°F) in less than 2 min. The machine shall contain an opening for the insertion of a thermometer or other equivalent equipment for determining the temperature of the water during the washing and rinsing procedures. It is equipped with an outside water gauge that will indicate the level of the water in the wheel. A washing machine of this type, such as Model 2420A, is available from: Robert Ewing and Sons Division, Powercom Corp., P.O. Box 454, Troy NY 12181.

18.3 An extracting machine, described as Model 305-TX, is available from Bock Laundry Machine Co., 3600 Summit St., Toledo OH 43611.

18.4 Marking pens with different size tips are available from Mark-Tex Corp., P.O. Box 681, Englewood NJ 07631; and AATCC, P.O. Box 12215, Research Triangle Park NC 27709; tel: 919/549-8141; fax: 919/549-8933; e-mail: orders@aatcc.org.

18.5 A ruled template marked in percent dimensional change is available from AATCC, P.O. Box 12215, Research Triangle Park NC 27709; tel: 919/549-8141; fax: 919/549-8933; e-mail: orders@aatcc.org. A mechanical marking device and measuring tape marked in percent dimensional change is available from Benchmark Devices Inc., 3305 Equestrian Trail, Marietta GA 30064; tel: 770/795-0042; fax: 770/421-8401; e-mail: bmarkers@bellsouth.net.

18.6 Screen or perforated conditioning/drying racks available from Somers Sheet Metal Inc., 5590 N. Church St., Greensboro NC 27405; tel: 336/643-3477; fax: 336/643-7443. Rack drawings are available from AATCC, P.O. Box 12215, Research Triangle Park NC 27709; tel: 919/549-8141; fax: 919/549-8933;

e-mail: orders@aatcc.org.

18.7 Laboratory forced-air type ovens are available from most laboratory equipment supply companies.

18.8 Schiefer Sock-Measuring Machine is available from Frazier Precision Instrument Co., 925 Sweeny Dr., Hagerstown MD 21740; tel: 301/790-2585.

18.9 A digital imaging system may be used as a measuring device in place of the prescribed manual measurement devices if it is established that its accuracy is equivalent to the manual devices.

18.10 Prepare a stock solution of the soap by dissolving 1 lb of chip soap in 1 gal of hot water. When cooled, this forms a thick homogeneous jelly which can be used as required. Standard Neutral Chip Soap is available from AATCC, P.O. Box 12215, Research Triangle Park NC 27709; tel: 919/549-8141; fax: 919/549-8933; e-mail: orders@aatcc.org.

18.11 Calgon or sodium tripolyphosphate can be used.

18.12 Ballast are available from The Wool Bureau Inc., 225 Crossways Park Dr., Woodbury NY 11797.

18.13 This type of detergent is available under different trade names from many detergent suppliers.

18.14 Dimensional change results obtained with the 50 cm or 18 in. bench marks may not be equal to those obtained with 25 cm (10 in.) bench marks.

18.15 "Federal Specifications for Stitches; Seams, and Stitching," obtainable from General Services Administration, Business Service Center, Washington DC 20407.

18.16 If information on the dimensional change variability within or between specimens is desired, calculate dimensional change based on the individual pairs of bench marks for within specimen data or based on the average of the three pairs of bench marks for between specimen data.

Antibacterial Finishes on Textile Materials: Assessment of

Developed in 1961 by AATCC Committee RA31; revised 1965, 1981, 1988 (with title change), 1993, 1999; editorially revised 1969, 1971, 1974, 1985; reaffirmed 1977, 1981, 1989, 1998; editorially revised and reaffirmed 1986, 2004.

1. Purpose and Scope

1.1 This test method provides a quantitative procedure for the evaluation of the degree of antibacterial activity. Assessment of antibacterial finishes on textile materials is determined by the degree of antibacterial activity intended in the use of such materials. If only bacteriostatic activity (inhibition of multiplication) is intended, a qualitative procedure which clearly demonstrates antibacterial activity as contrasted with lack of such activity by an untreated specimen may be acceptable. However, if bactericidal activity is intended or implied, quantitative evaluation is necessary. Quantitative evaluation also provides a clearer picture for possible uses of such treated textile materials.

2. Principle

2.1 Swatches of test and control textile materials are tested qualitatively for antibacterial activity by AATCC Method 147. Those showing activity are evaluated quantitatively. Test and control swatches are inoculated with the test organisms. After incubation, the bacteria are eluted from the swatches by shaking in known amounts of neutralizing solution. The number of bacteria present in this liquid is determined, and the percentage reduction by the treated specimen is calculated.

3. Terminology

3.1 **activity**, n.—*of an antibacterial agent*, a measure of effectiveness of the agent.

3.2 **antibacterial agent**, n.—*in textiles*, any chemical which kills bacteria (bactericide) or interferes with the multiplication, growth or activity of bacteria (bacteriostat).

4. Safety Precautions

NOTE: These safety precautions are for information purposes only. The precautions are ancillary to the testing procedures and are not intended to be all inclusive. It is the user's responsibility to use safe and proper techniques in handling materials in this test method. Manufacturers MUST be consulted for specific

details such as material safety data sheets and other manufacturer's recommendations. All OSHA standards and rules must also be consulted and followed.

4.1 Both the qualitative and quantitative tests should be carried out by persons with training and experience in the use of bacteriological techniques. The U.S. Department of Health and Human Services publication, *Biosafety in Microbiological and Biomedical Laboratories*, should be consulted (see 13.1).

4.2 CAUTION: Some of the bacteria used in this test are capable of infecting humans and producing disease. Therefore, every necessary and reasonable precaution must be taken to eliminate this risk to the laboratory personnel and to personnel in the associated environment. Wear protective clothing and respiratory protection that prevents penetration by the bacteria.

4.3 Good laboratory practices should be followed. Wear safety glasses in all laboratory areas.

4.4 All chemicals should be handled with care.

4.5 An eyewash/safety shower should be located nearby for emergency use.

4.6 Sterilize all contaminated samples and test materials prior to disposal.

4.7 Exposure to chemicals used in this procedure must be controlled at or below levels set by government authorities (e.g., Occupational Safety and Health Administration's [OSHA] permissible exposure limits [PEL] as found in 29 CFR 1910.1000 of January 1, 1989). In addition, the American Conference of Governmental Industrial Hygienists (ACGIH) Threshold Limit Values (TLVs) comprised of time weighted averages (TLV-TWA), short term exposure limits (TLV-STEL) and ceiling limits (TLV-C) are recommended as a general guide for air contaminant exposure which should be met (see 13.2).

5. Limitations

5.1 For a qualitative, relatively quick and easily executed method to determine residual antibacterial activity of textile materials, refer to AATCC Method 147, Antibacterial Activity Assessment of Textile Materials: Parallel Streak Method.

6. Test Organisms

6.1 Test bacteria.

6.1.1 *Staphylococcus aureus*, American Type Culture Collection No. 6538. Gram positive organism (see 13.10).

6.1.2 *Klebsiella pneumoniae*, Ameri-

can Type Culture Collection No. 4352. Gram negative organism (see 13.10).

6.1.3 Other suitable species can also be used.

7. Culture Medium

7.1 Suitable broth/agar media are Nutrient, Trypticase Soy and Brain-Heart Infusion.

Nutrient Broth:

Peptone (Bacto-peptone)

(see 13.3) 5 g

Beef extract (see 13.4) 3 g

Distilled water to 1000 mL

7.2 Heat to a boil to disperse ingredients. Adjust to pH 6.8 ± 0.1 with 1N sodium hydroxide (NaOH) solution. (This is not necessary if prepared, dehydrated medium is used.)

7.3 Dispense in 10 mL amounts in conventional bacteriological culture tubes (i.e., 125 × 17 mm). Plug and sterilize at 103 kPa (15 psi) for 15 min.

7.4 Nutrient agar. Add 1.5% bacteriological agar to nutrient (or appropriate) broth (see 7.1). Heat to boiling. Check pH and adjust to 7.1 ± 0.1 using NaOH solution if necessary. Dispense in 15 ± 1 mL amounts in conventional bacteriological culture tubes. Plug and sterilize at 103 kPa (15 psi) for 15 min. (May be sterilized in 1000 mL borosilicate glass flasks and petri dishes poured from this.)

7.5 Slurry Inoculum Carrier (for hydrophobic fabrics) (see 7.2 and 7.3):

Sodium Chloride 8.5 g

Agar 3.0 g

Distilled Water 1000 mL

8. Maintenance of Culture of Test Organisms

8.1 Using a 4 mm inoculating loop, transfer the culture daily in nutrient (or appropriate medium) broth for not more than two weeks. At the conclusion of two weeks, make a fresh transplant from stock culture. Incubate cultures at $37 \pm 2^\circ\text{C}$ ($99 \pm 3^\circ\text{F}$) or other optimal temperature.

8.2 Maintain stock cultures on nutrient or appropriate agar slants. Store at $5 \pm 1^\circ\text{C}$ ($41 \pm 2^\circ\text{F}$) and transfer once a month to fresh agar (see 13.5).

9. Qualitative Test (Screening or Presumptive Test)

9.1 For detection of bacteriostatic activity use AATCC Method 147 on a test specimen and control specimen using the organisms referred to above. For demonstration of bactericidal activity, proceed to the quantitative test described below.

10. Quantitative Test (Reference or Confirmatory Test)

10.1 Preparation. The following description will be in terms of fabric swatches. Textile materials not in fabric form can likewise be tested with the appropriate modification.

10.1.1 Size and shape of treated swatches: Cut circular swatches 4.8 ± 0.1 cm (1.9 ± 0.03 in.) in diameter, from the test fabric (preferably with a steel die). Stack the swatches in a 250 mL wide-mouth glass jar with screw cap. The number of swatches to be used is dependent on the fiber type and fabric construction. Use that amount of fabric which will absorb the 1.0 ± 0.1 mL of inoculum, and leave no free liquid in the jar. For example, 4 swatches of cotton print cloth will absorb 1 mL. The number of swatches used per jar should be reported.

10.1.2 Controls. Swatches of the same fiber type and fabric construction as test sample but containing no antibacterial finish (negative control).

10.1.3 Sterilization of samples. This is optional. The method to be used depends on the type of fiber and finish. Cotton, acetate and many manmade fibers can be sterilized in the autoclave. Wool can be sterilized by ethylene oxide or by intermittent (fractional) sterilization in flowing steam. The latter is also least damaging to certain finishes. Report method of sterilization, if used.

10.1.4 Size of inoculum per sample. Apply 1.0 ± 0.1 mL of an appropriate dilution of a 24 h broth culture of the test organism so that recovery from (1) untreated control fabric swatches or (2) treated test fabric swatches at "0" contact time (plated as soon as possible after inoculation) will show counts of $1-2 \times 10^5$ organisms. The dilution of the test organism should be made in nutrient (or appropriate) broth (see 7.1, 7.5 and 13.6).

10.2 Procedure.

10.2.1 Inoculation of fabrics. When using *Staphylococcus aureus*, shake a 24 h culture and let stand for 15-20 min before preparing the inoculum.* Place the swatches separately in sterile petri dishes and use a microliter pipette to inoculate them making sure that there is even distribution of the inoculum (see 13.7). Transfer these swatches aseptically to the jar. Screw the jar tops on tightly to prevent evaporation.

10.2.2 As soon as possible after inoculation ("0" contact time), add 100 ± 1 mL

of neutralizing solution to each of the jars containing the inoculated untreated control swatches, the inoculated treated test swatches and the uninoculated treated test swatches.

10.2.3 The neutralizing solution should include ingredients to neutralize the specific antibacterial fabric treatment and to take care of any pH requirements of the fabrics (from finishes, antibacterial agents, etc.). The neutralizing solution employed should be reported (see 13.8).

10.2.4 Shake the jars vigorously for one minute. Make serial dilutions with water and plate (in duplicate) on nutrient (or appropriate) agar. Dilutions of 10^0 , 10^1 , 10^2 are usually suitable.

10.2.5 Incubation over contact periods. Incubate additional jars containing inoculated untreated control swatches and jars containing inoculated treated test swatches at $37 \pm 2^\circ\text{C}$ ($99 \pm 3^\circ\text{F}$) for 18-24 h. Similar jars may be incubated over other periods (e.g., 1 or 6 h) to provide information about the bactericidal activity of the treatment over such periods.

10.2.6 Sampling of inoculated and incubated swatches. After incubation, add 100 ± 1 mL of neutralizing solution to jars containing untreated control swatches and to jars containing treated test swatches. Shake the jars vigorously for one minute. Make serial dilutions and plate (in duplicate) on nutrient (or appropriate) agar. Dilutions of 10^0 , 10^1 , 10^2 are usually suitable for treated test fabrics. Several different dilutions may be required for untreated control fabrics depending on the incubation period.

10.2.7 Incubate all plates for 48 h at $37 \pm 2^\circ\text{C}$ ($99 \pm 3^\circ\text{F}$) or other optimal temperature.

11. Evaluation

11.1 Report bacterial counts as the number of bacteria per sample (swatches in jar) not as the number of bacteria per mL of neutralizing solution. Report "0" counts at 10^0 dilution as "less than 100."

11.2 Calculate percent reduction of bacteria by the specimen treatments by one of the following formulas:

$$1) \quad 100(B - A)/B = R$$

where:

R = % reduction

A = the number of bacteria recovered from the inoculated treated test specimen swatches in the jar incubated over the desired contact period

B = the number of bacteria recovered from the inoculated treated test specimen swatches in the jar immediately after inoculation (at "0" contact time)

$$2) \quad 100(C - A)/C = R$$

where:

C = the number of bacteria recovered from the inoculated untreated control specimen swatches in the jar immediately after inoculation (at "0" contact time)

If " B and C " are not similar, the larger number should be used. If " B " and " C " are not significantly different, $(B + C)/2$ should be used as follows:

$$3) \quad 100(D - A/D) = R$$

where:

$$D = (B + C)/2$$

11.3 If an untreated control is not available, use the following calculation which allows for any background organisms that might interfere with the test.

$$Bg = 100[(B - E) - (A - F)/B - E]$$

where:

A, B = (see 11.2)

E = the number of bacteria initially recovered from the uninoculated treated test sample (existing background organisms)

F = The number of bacteria recovered from the uninoculated, pre-wet treated test sample after incubation in the jar over the desired contact period (existing background organisms after contact period)

Bg = background organisms

11.4 For a valid test there should be: (1) "0" colonies of test organism recovered from the uninoculated treated test specimen swatches and (2) a significant increase in the numbers of bacteria recovered from the inoculated untreated control specimen swatches incubated for the specified contact time over the numbers of bacteria recovered from the inoculated untreated specimen swatches at "0" contact time (immediately after inoculation). This applies only if dilution was made in broth (see 10.1.4 and 13.6).

11.5 Report percent reduction of bacteria by the specimen treatment against each test organism.

11.6 The criterion for passing the test must be determined by the interested parties.

11.7 Report the dilution medium used.

12. Precision and Bias

12.1 Studies (see 13.9) indicate the following *within-laboratory* precision of the Standard Plate Count (SPC) Test: (a) *among-analyst* variation of 18% and (b) *within-analyst* variation of 8%.

13. Notes and References

13.1 Publication available from U.S. Department of Health and Human Services CDC/

*Using a 1 mL pipette, pad the inoculum carefully onto the fabric. If a strain of *Pseudomonas* that forms a pellicle is used, avoid including fragments of the pellicle in the inoculum.

NIH-HHS Publication No. (CDC) 84-8395.

13.2 Booklet available from Publications Office, ACGIH, Kemper Woods Center, 1330 Kemper Meadow Dr., Cincinnati OH 45240; tel: 513/742-2020.

13.3 Bacto-Peptone may be obtained from Difco Laboratories, 920 Henry St., Detroit MI 48201.

13.4 Beef extract may be obtained from Baltimore Biological Laboratories, 250 Schilling Cir., Cockeysville MD 21030; Difco Laboratories (address above); or Oxoid (USA) Ltd., 9017 Red Branch Rd., Columbia MD 21045.

13.5 Consistent and accurate testing requires maintenance of a pure, uncontaminated,

nonmutant test culture. Avoid contamination by use of good sterile technique in plating and transferring. Avoid mutation by strict adherence to monthly stock transfers. Check culture purity by making streak plates periodically and observing for single species-characteristic type of colonies.

13.6 The dilution of the test organism may be prepared in sterile 0.85% saline solution or suitable buffer if a steady-state culture is desired during the contact period with a fabric or in the slurry inoculum carrier when hydrophobic fabrics are being tested.

13.7 A surfactant may be added to the dilution medium to enhance wetting of hydrophobic fabrics. The surfactant must be shown not

to cause a reduction in bacterial numbers, by prior testing at the intended use concentration. Report the use and concentration of surfactant used.

13.8 If sterile distilled water is used in the place of a neutralizing solution, there will always be the possibility that some of the biocide will be carried over.

13.9 Peeler, J. T.; Leslie, J. W.; Messer, J. W. Replicate counting errors by analysts and bacterial colony counters. *J. Food Protection*, Vol. 45, 1982, pp 238-240.

13.10 Available from American Type Culture Collection (ATCC), P.O. Box 1549, Manassas VA 20108; tel: 703/365-2700; fax: 703/365-2701.

Colorfastness to Bleaching with Hydrogen Peroxide

Developed in 1961 by AATCC Committee RA34; revised 1963, 1968, 1972, 2004; reaffirmed 1975, 1979, 1984, 1999; editorially revised 1985, 1987, 1995, 2001, 2002; editorially revised and reaffirmed 1989, 1994 (with title change). Related to ISO 105-N02.

1. Purpose and Scope

1.1 This test method is intended for evaluating the resistance of the color of textiles of all kinds except polyamide, in all forms, to the action of bleach baths containing hydrogen peroxide at concentrations commonly employed in textile processing.

2. Principle

2.1 A specimen of the textile in contact with specified white cloths is immersed in the bleaching solution, rinsed and dried. The change in color of the specimen and the staining of the test cloths are evaluated.

3. Terminology

3.1 **colorfastness**, n.—the resistance of a material to change in any of its color characteristics, to transfer of its colorant(s) to adjacent materials, or both, as a result of the exposure of the material to any environment that might be encountered during the processing, testing, storage or use of the material.

4. Safety Precautions

NOTE: These safety precautions are for information purposes only. The precautions are ancillary to the testing procedures and are not intended to be all inclusive. It is the user's responsibility to use safe and proper techniques in handling materials in this test method. Manufacturers MUST be consulted for specific details such as material safety data sheets and other manufacturer's recommendations. All OSHA standards and rules must also be consulted and followed.

4.1 Good laboratory practices should be followed. Wear safety glasses in all laboratory areas.

4.2 In preparing bleaching baths, use appropriate personal protective equipment while handling hydrogen peroxide (35%) and sodium hydroxide concentrates. Chemical goggles or face shield, rubber gloves and rubber apron should be worn during preparation steps involving

these materials.

4.3 An eyewash/safety shower should be located nearby for emergency use.

4.4 Use proper protective equipment, such as gloves and metal tongs, during handling of hot sample tubes.

4.5 Exposure to chemicals used in this procedure must be controlled at or below levels set by governmental authorities (e.g., Occupational Safety and Health Administration's [OSHA] permissible exposure limits [PEL] as found in 29 CFR 1910.1000 of January 1, 1989). In addition, the American Conference of Governmental Industrial Hygienists (ACGIH) Threshold Limit Values (TLVs) comprised of time weighted averages (TLV-TWA), short term exposure limits (TLV-STEL) and ceiling limits (TLV-C) are recommended as a general guide for air contaminant exposure which should be met (see 12.6).

5. Apparatus and Materials

5.1 Test tube or beaker, diameter and length such that the test specimen roll will have a reasonably snug fit and be covered by the bleach solution.

5.2 Bleach bath of the applicable composition given in Table I.

5.3 Two white test cloths, each 10.2 × 3.8 cm (4.0 × 1.5 in.), one piece made of the same kind of fiber as that of the textile to be tested, the second piece made of the fiber indicated in Table II. A white multifiber test fabric (see 12.4) may be used instead of the second white cloth.

5.4 Gray Scale for Staining (see 12.7).

5.5 AATCC Chromatic Transference Scale (see 12.7).

6. Test Specimens

6.1 If the textile to be tested is cloth, place a 10.2 × 3.8 cm (4.0 × 1.5 in.) specimen of it between the two pieces of white cloth, and sew along all four sides to form a composite specimen.

6.2 If the textile to be tested is yarn, knit it into cloth and sew the knitted cloth as above, or form a layer of parallel lengths of yarn between the two white cloths, and sew around the four sides to hold the yarns in place.

6.3 If the textile to be tested is fiber, comb and compress some of it into a sheet 10.2 × 3.8 cm (4.0 × 1.5 in.) in size, place the sheet between the two white cloths, and sew around the four sides to form a composite specimen.

7. Procedure (see 12.2)

7.1 For Tests I, II, III, loosely roll the composite specimen in the direction of the long edge, place the roll in the test tube. Immerse cloth in the appropriate bleach solution (Table I), and keep it submerged for the indicated time and temperature (Table I).

7.2 For Test IV, saturate the composite specimen with 100% of its weight of the appropriate bleach solution (Table I), roll in the direction of the long edge and place in saturated steam (see 12.3) at 99-101°C (210-214°F) for 1 h.

7.3 Remove the composite specimen, rinse for 10 min in flowing cold tap water and squeeze. Remove the stitching on two long sides and one short side, open the specimen, and dry at a temperature not exceeding 60°C (140°F) with the

Table I—Composition of Bleaching Bath and Conditions of Use

	Test I Wool	Test II Silk (Quantities per liter of distilled water)	Test III Cotton	Test IV Cotton
Hydrogen peroxide, 35% ^a	15.4 mL (17.5 g)	8.8 mL (10.0 g)	8.8 mL (10.0 g)	8.8 mL (10.0 g)
Sodium silicate, 42° Be ^b		5.1 mL (7.2 g)	4.2 mL (6.0 g)	7.0 mL (10.0 g)
Sodium pyrophosphate ^c	5.0 g			
Sodium hydroxide ^d			0.5 g	0.5 g
Wetting agent ^e			2.0 mL	
pH (initial) ^f	9.0-9.5	10.5	10.5	10.5
Time	2 h	1 h	2 h	1 h
Temperature	49°C (120°F)	82°C (180°F)	88°C (190°F)	100°C (212°F)
Liquor to cloth ratio	30:1	30:1	30:1	1:1

^a By weight.

^b 42° Be, water white, 10.6% Na₂O, 11.8 lb/gal.

^c Na₂P₂O₇ · 10H₂O.

^d C.P. grade.

^e Doubly sulfonated castor oil.

^f Adjust with NaOH solution if necessary.

Table II—Choice of Test Cloth

If first piece is	Second piece to be
Wool, silk, linen, rayon	Cotton or multifiber test fabric (see 12.4)
Cotton, acetate	Viscose rayon or multifiber test fabric (see 12.1)

three parts in contact only at the one line of stitching.

8. Evaluation Method for Alteration in Color (Shade and Strength).

8.1 Rate the color change of the test specimens using the Gray Scale for Color Change (usage of the scale is discussed in AATCC Evaluation Procedure 1). For improved precision and accuracy, the specimens should be rated by more than one rater.

Grade 5—negligible or no change as shown in Gray Scale Step 5.

Grade 4.5—change in color equivalent to Gray Scale Step 4-5.

Grade 4—change in color equivalent to Gray Scale Step 4.

Grade 3.5—change in color equivalent to Gray Scale Step 3-4.

Grade 3—change in color equivalent to Gray Scale Step 3.

Grade 2.5—change in color equivalent to Gray Scale Step 2-3.

Grade 2—change in color equivalent to Gray Scale Step 2.

Grade 1.5—change in color equivalent to Gray Scale Step 1-2.

Grade 1—change in color equivalent to Gray Scale Step 1.

8.1.1 The color change can be quantitatively determined between the original sample and a test specimen using a suitable colorimeter or spectrophotometer (see AATCC Evaluation Procedure 7, Instrumental Assessment of the Change in Color of a Test Specimen).

9. Evaluation Method for Staining

9.1 Rate staining by using the Gray Scale for Staining or the AATCC Chromatic Transference Scale (usage of the scales is discussed in AATCC Evaluation Procedures 2 and 8). The scale used should be indicated when reporting the

test results as follows:

Grade 5—negligible or no color transfer.

Grade 4.5—color transfer equivalent to Step 4-5 on the Gray Scale for Staining or Row 4.5 on the 9-step AATCC Chromatic Transference Scale.

Grade 4—color transfer equivalent to Step 4 on the Gray Scale for Staining or Row 4 on the 9-step AATCC Chromatic Transference Scale.

Grade 3.5—color transfer equivalent to Step 3-4 on the Gray Scale for Staining or Row 3.5 on the 9-step AATCC Chromatic Transference Scale.

Grade 3—color transfer equivalent to Step 3 on the Gray Scale for Staining or Row 3 on the 9-step AATCC Chromatic Transference Scale.

Grade 2.5—color transfer equivalent to Step 2-3 on the Gray Scale for Staining or Row 2.5 on the 9-step AATCC Chromatic Transference Scale.

Grade 2—color transfer equivalent to Step 2 on the Gray Scale for Staining or Row 2 on the 9-step AATCC Chromatic Transference Scale.

Grade 1.5—color transfer equivalent to Step 1-2 on the Gray Scale for Staining or Row 1.5 on the 9-step AATCC Chromatic Transference Scale.

Grade 1—color transfer equivalent to Step 1 on the Gray Scale for Staining or Row 1 on the 9-step AATCC Chromatic Transference Scale.

10. Report

10.1 Report the following information for each type of white fiber used in the test:

The bleach solution used (test number in Table I).

The classification of alteration in color.

The classification of staining.

The classification chart used (AATCC Chromatic Transference Scale or Gray Scale for Staining).

11. Precision and Bias

11.1 *Precision.* In 2000 a single laboratory study was performed using a single operator.

11.1.1 Samples tested consisted of six fabrics with three replicates each. Refer to Table 1 for the bleach formulas and

conditions used. Color change and staining were evaluated instrumentally for each sample.

11.1.2 *Within-laboratory* standard errors and sample variance are shown in Table III on page 154. Data is on file at the AATCC Technical Center.

11.2 *Bias.* Colorfastness to bleaching with hydrogen peroxide can be defined only in terms of a test method. There is no independent method for determining the true value. As a means of estimating this property, the method has no known bias.

12. Notes

12.1 The white cloths should be plain weave, *medium* weight, free from finishes, residual chemicals and chemically damaged fibers. Cotton and linen should be bleached; other materials should be cleaned to their usual degree of whiteness. A white multifiber test fabric (see 12.4) may be used instead of the second white cloth.

12.2 Select from Table I the test most suitable for the conditions under which the fiber is to be used. For example, if a colored silk is to be used as an effect thread in a woolens or worsted fabric, check its colorfastness by the wool method. If a colored silk is to be used as an effect thread in a silk fabric, check its colorfastness by the silk method.

12.3 Saturated steam may be obtained by placing approximately 20 mL of water in the bottom of a test tube fitted with a flared glass rod long enough to keep the specimens above the water level. Heat to active boil. Use a reflux condenser to maintain volume of liquor. Invert a small watch glass over the specimen to prevent direct impingement on the sample of water drops from the condenser.

12.4 Available from Testfabrics Inc., P.O. Box 26, 415 Delaware St., W. Pittston PA 18643; tel: 570/603-0432; fax: 570/603-0433; e-mail: testfabric@aol.com; and Textile Innovators Corp., div. of SDL Atlas L.L.C., P.O. Box 8, 101 Forest St., Windsor NC; tel: 252/794-9703; fax: 252/794-9704; e-mail: tic@sdlatlas.com.

12.5 For very critical evaluations and in cases of arbitration, ratings must be based on the geometric gray scale for evaluating staining.

12.6 Available from Publications Office, ACGIH, Kemper Woods Center, 1330 Kemper Meadow Dr., Cincinnati OH 45240; tel: 513/742-2020.

12.7 Available from AATCC, P.O. Box 12215, Research Triangle Park NC 27709; tel: 919/549-8141; fax: 919/549-8933; e-mail: orders@aatcc.org.

Table III—Within-Laboratory Standard Errors and Sample Variance

Sample Identification	Test Parameter	Mean Value	Standard Deviation	Standard Error	Sample Variance	Critical Difference
Brown Wool (Test 1)	Color Change	3.00	0.00	0.00	0.00	0.00
	Color Transfer	4.17	0.29	0.17	0.08	0.50
	<u>Multifiber Stain</u>					
	Acetate	4.17	0.58	0.33	0.33	1.01
	Cotton	4.67	0.29	0.17	0.08	0.50
	Nylon	3.33	0.58	0.33	0.33	1.01
	Polyester	4.67	0.29	0.17	0.08	0.50
	Acrylic	5.00	0.00	0.00	0.00	0.00
Wool	3.67	0.29	0.17	0.08	0.50	
Green Wool (Test 1)	Color Change	2.50	0.50	0.29	0.25	0.87
	Color Transfer	1.67	0.29	0.17	0.08	0.50
	<u>Multifiber Stain</u>					
	Acetate	3.33	0.29	0.17	0.08	0.50
	Cotton	3.33	0.29	0.17	0.08	0.50
	Nylon	2.00	0.00	0.00	0.00	0.00
	Polyester	4.50	0.50	0.29	0.25	0.87
	Acrylic	4.17	0.29	0.17	0.08	0.50
Wool	3.50	0.87	0.50	0.75	1.51	
Red Silk (Test 2)	Color Change	3.17	0.29	0.17	0.08	0.50
	Color Transfer	2.00	0.00	0.00	0.00	0.00
	<u>Multifiber Stain</u>					
	Acetate	1.67	0.29	0.17	0.08	0.50
	Cotton	3.33	0.58	0.33	0.33	1.01
	Nylon	1.67	0.29	0.17	0.08	0.50
	Polyester	2.83	0.29	0.17	0.08	0.50
	Acrylic	4.33	0.29	0.17	0.08	0.50
Wool	2.50	0.00	0.00	0.00	0.00	
Blue Silk (Test 3)	Color Change	2.00	0.00	0.00	0.00	0.00
	Color Transfer	4.67	0.29	0.17	0.08	0.50
	<u>Multifiber Stain</u>					
	Acetate	5.00	0.00	0.00	0.00	0.00
	Cotton	4.50	0.87	0.50	0.75	1.51
	Nylon	5.00	0.00	0.00	0.00	0.00
	Polyester	5.00	0.00	0.00	0.00	0.00
	Acrylic	5.00	0.00	0.00	0.00	0.00
Wool	4.33	0.29	0.17	0.08	0.50	
Purple Cotton (Test 3)	Color Change	3.83	0.29	0.17	0.08	0.50
	Color Transfer	4.67	0.29	0.17	0.08	0.50
	<u>Multifiber Stain</u>					
	Acetate	4.33	0.29	0.17	0.08	0.50
	Cotton	4.67	0.29	0.17	0.08	0.50
	Nylon	4.50	0.00	0.00	0.00	0.00
	Polyester	4.50	0.00	0.00	0.00	0.00
	Acrylic	4.50	0.00	0.00	0.00	0.00
Wool	3.50	0.00	0.00	0.00	0.00	
Gray Cotton (Test 3)	Color Change	3.67	0.29	0.17	0.08	0.50
	Color Transfer	5.00	0.00	0.00	0.00	0.00
	<u>Multifiber Stain</u>					
	Acetate	4.50	0.00	0.00	0.00	0.00
	Cotton	4.83	0.29	0.17	0.08	0.50
	Nylon	4.67	0.29	0.17	0.08	0.50
	Polyester	4.50	0.00	0.00	0.00	0.00
	Acrylic	4.50	0.00	0.00	0.00	0.00
Wool	3.50	0.00	0.00	0.00	0.00	

*Note: Because the interlaboratory test included less than five laboratories, estimates of standard error and sample variance may be either underestimated or overestimated to a considerable extent and should be used with special caution. The values should be viewed as minimal data with regards to precision. Confidence levels are not well established.

Determination of Hydrogen Peroxide by Potassium Permanganate Titration

Developed in 1957 by AATCC Committee RA34; reaffirmed 1962, 1968, 1972, 1975, 1979, 2002; editorially revised (with title change) 1983; editorially revised and reaffirmed 1985, 1992; revised 1987 (with title change), 1997.

1. Purpose and Scope

1.1 This test method determines the concentration of hydrogen peroxide (H_2O_2) in aqueous solutions, particularly those used in textile bleaching.

2. Principle

2.1 A specimen is acidified with sulfuric acid and titrated with standardized potassium permanganate solution. The concentration of hydrogen peroxide is calculated using the volume and normality of the permanganate solution used.

3. Terminology

3.1 **bleaching**, n.—elimination of unwanted coloring matter from a textile substrate by oxidative or reductive chemical treatment.

4. Safety Precautions

NOTE: These safety precautions are for information purposes only. The safety precautions are ancillary to the testing procedures and are not intended to be all inclusive. It is the user's responsibility to use safe and proper techniques in handling materials in this test method. Manufacturers MUST be consulted for specific details such as material safety data sheets and other manufacturer's recommendations. All OSHA standards and rules must also be consulted and followed.

4.1 Good laboratory practices should be followed. Wear safety glasses in all laboratory areas.

4.2 All chemicals should be handled with care. Sodium oxalate, potassium permanganate and sulfuric acid are corrosive. When preparing the dilute solutions from pure or concentrated reagents, use chemical goggles or face shield, impervious gloves, and an impervious apron. CAUTION: Always add acid to water.

4.3 An eyewash/safety shower should be located nearby and a high efficiency particulate respirator with organic vapor

cartridge and full facepiece should be readily available for emergency use.

4.4 Exposure to chemicals used in this procedure must be controlled at or below levels set by governmental authorities (e.g., Occupational Safety and Health Administration's [OSHA] permissible exposure limits [PEL] as found in 29 CFR 1910.1000 of January 1, 1989). In addition, the American Conference of Governmental Industrial Hygienists (ACGIH) Threshold Limit Values (TLVs) comprised of time weighted averages (TLV-TWA), short term exposure limits (TLV-STEL) and ceiling limits (TLV-C) are recommended as a general guide for air contaminant exposure which should be met (see 11.1).

5. Apparatus

5.1 Filter funnel, fritted glass, fine porosity, 250 mL.

5.2 Filtration flask, 2000 mL.

6. Reagents

6.1 Sodium oxalate ($Na_2C_2O_4$), crystals, CP.

6.2 Sulfuric acid (H_2SO_4), 95-98%.

6.3 Potassium permanganate ($KMnO_4$), crystals.

7. Preparation of Reagents

7.1 Standard 0.100N sodium oxalate solution.

7.1.1 Dry at least 7 g sodium oxalate in an oven at $105 \pm 1^\circ C$ for 4 h and cool in a desiccator.

7.1.2 Weigh 6.7000 ± 0.0002 g sodium oxalate (see 7.1.1) and dissolve in 250-300 mL distilled or deionized water at $70 \pm 10^\circ C$.

7.1.3 Cool and quantitatively transfer to a 1 L volumetric flask and cover. Allow to stand at least 12 h, then dilute to the mark with distilled or deionized water.

7.2 Sulfuric acid, approximately 20% by volume (see Section 4 for safety precautions).

7.2.1 Slowly add 200 mL 95-98% sulfuric acid to 800 mL water with stirring. Cool to $20 \pm 2^\circ C$.

7.2.2 Add water to 1 L.

7.3 Potassium permanganate solution 0.588N (see 11.2).

7.3.1 Weigh 18.6 ± 0.1 g potassium permanganate and add it to 900 mL water.

7.3.2 Boil the solution for 15 min and cool.

7.3.3 Filter the solution through a filter funnel (see 5.1) into a 1 L volumetric flask. Dilute to the mark with water.

7.3.4 Store solutions of potassium permanganate in brown bottles or otherwise protect the solutions from light.

7.4 Standardization of 0.588N potassium permanganate solution. Make three determinations as follows.

7.4.1 Pipette 100 mL 0.100N sodium oxalate solution into a 250 mL Erlenmeyer flask and add 10 ± 1 mL 20% sulfuric acid.

7.4.2 Heat to boiling. Remove from heat and immediately titrate with the potassium permanganate solution being standardized, adding the titrant drop by drop at the beginning and at the end of the titration. The end-point is a faint but permanent pink color.

7.4.3 Calculate the normality of the potassium permanganate solution to the nearest 0.001 using the following equation:

$$N_k = (V_o)(N_o)/(V_k)$$

where:

V_o = volume of the sodium oxalate solution used, in mL

N_o = normality of the sodium oxalate solution

V_k = volume of the potassium permanganate solution used, in mL

7.4.4 Average the three normality values and use that average for all calculations.

8. Procedure

8.1 Weigh 10 ± 0.1 g of the aqueous hydrogen peroxide specimen into a 250 mL flask (see 11.3).

8.2 Add 20 ± 1 mL 20% sulfuric acid to the flask (see 7.2). Gently mix by swirling or stirring.

8.3 Titrate the solution with standardized potassium permanganate solution (see 7.3 and 7.4) to a faint pink color which lasts at least 30 s. Record the volume of titrant in milliliters as V_r .

8.3.1 If less than 2 mL of titrant are used, repeat the procedure using either a standardized potassium permanganate solution of known lower normality or a larger specimen.

8.4 Titrate a blank, and record the mL titrant required as V_b .

9. Calculations

9.1 Calculate the % H₂O₂ to the nearest 0.01% using the following equation:

% H₂O₂ as 100%

$$= (V_t - V_b)(N_t)(0.017)(100)/(W_s)$$

where:

V_t = volume of titrant in mL

V_b = volume of titrant in mL for blank sample

N_t = normality of the titrant solution

W_s = specimen mass, in g

9.2 If 0.588N KMnO₄ solution is used as the titrant and the specimen mass is 10 g, the equation reduces to:

$$\% \text{H}_2\text{O}_2 \text{ as } 100\% = (0.1)(V_t - V_b)$$

9.3 Using the conditions of 9.2, for reporting % H₂O₂ on other bases, such as 35% or 50%, V_t may be multiplied by the factor 10/ B , where B is the basis expressed as % H₂O₂. For example, if the basis is 35%,

% H₂O₂ as 35%

$$= (V_t - V_b)(10)/(35) = (V_t - V_b)(0.286)$$

10. Precision and Bias

10.1 Precision.

10.1.1 In 1993 an interlaboratory study included five laboratories, with two oper-

ators each, evaluating two concentrations of hydrogen peroxide in aqueous solution. Two batches of each concentration were prepared. Each operator made duplicate determinations on four separate occasions for each of the two batches, a total of 16 determinations per operator per concentration (2 × 4 × 2). The data set was analyzed using the ASTM Tex-Pac program (see 11.4).

10.1.2 Analysis showed the residual variances of the two concentrations were different. Accordingly, critical difference tables, with the number of determinations per average shown as n , were prepared for each concentration

10.2 Bias.

10.2.1 Concentration of hydrogen peroxide in aqueous solution can be defined only in terms of a test method. Within this limitation, this method has no known bias in the determination of percent hydrogen peroxide.

Table I—Critical Differences for Two Averages, 95% Probability Level

Hydrogen Peroxide (Grand Average = 0.65%)

n	Single Operator	Within-Laboratory	Between-Laboratories
1	0.03	0.04	0.05
2	0.02	0.03	0.05
4	0.01	0.03	0.04
8	0.01	0.02	0.04

Table II—Critical Differences for Two Averages, 95% Probability Level

Hydrogen Peroxide (Grand Average = 2.88%)

n	Single Operator	Within-Laboratory	Between-Laboratories
1	0.05	0.06	0.11
2	0.04	0.04	0.11
4	0.03	0.04	0.10
8	0.02	0.03	0.10

11. Notes

11.1 Available from Publications Office, ACGIH, Kemper Woods Center, 1330 Kemper Meadow Dr., Cincinnati OH 45240; tel: 513/742-2020.

11.2 The most widely used standard solution of potassium permanganate is 0.588N. This concentration and 0.1N solution are available from laboratory supply companies.

11.3 If a volumetric aliquot of the aqueous hydrogen peroxide solution is used as the specimen, the specimen mass may be determined from the relationship:

Specimen mass

$$= \text{volume of aliquot (mL)} \times \text{density (g/mL)}$$

The aliquot must be taken at the temperature at which the density is determined. For mill control purposes the density is often disregarded if the bleaching formula remains constant from day to day.

11.4 Available from ASTM, 100 Barr Harbor Dr., West Conshohocken PA 19428; tel: 610/832-9500; fax: 610/832-9555.

Bacterial Alpha-Amylase Enzymes used in Desizing, Assay of

Developed in 1962 by AATCC Committee RA41; Jurisdiction transferred in 1987 to Committee RA34, returned to RA41 in 1993; reaffirmed 1965, 1970, 1973, 1976, 1979, 1984, 2004; editorially revised 1985, 1986, 1991; editorially revised and reaffirmed 1989, 1994; revised 1999.

1. Purpose and Scope

1.1 This test method is intended for the assay of the bacterial amylases employed commercially for textile desizing. It is not applicable to products which contain *beta*-amylase in addition to *alpha*-amylase.

2. Principle

2.1 Dextrinogenic amylase activity is measured in terms of the digestion time required to produce a color change denoting a definite stage of dextrinization of the starch substrate. The amylase content of the sample, expressed in Bacterial Amylase Units (BAU), is readily calculated from the dextrinizing time.

3. Terminology

3.1 **Bacterial Amylase Unit (BAU)**, n.—a measure of starch degradation as shown by the quantity of an enzyme that will dextrinize one milligram of starch per minute under the specified experimental conditions.

4. Safety Precautions

NOTE: These safety precautions are for information purposes only. The precautions are ancillary to the testing procedures and are not intended to be all inclusive. It is the user's responsibility to use safe and proper techniques in handling materials in this test method. Manufacturers MUST be consulted for specific details such as material safety data sheets and other manufacturer's recommendations. All OSHA standards and rules must also be consulted and followed.

4.1 Good laboratory practices should be followed. Wear safety glasses in all laboratory areas.

4.2 All chemicals should be handled

with care. Use chemical goggles or face shield, impervious gloves and an impervious apron during dispensing and mixing of iodine; this is a corrosive chemical.

4.3 An eyewash/safety shower should be located nearby and a self-contained breathing apparatus should be readily available for emergency use.

4.4 Exposure to chemicals used in this procedure must be controlled at or below levels set by governmental authorities [e.g., Occupational Safety and Health Administration's (OSHA) permissible exposure limits (PEL) as found in 29 CFR 1910.1000 of January 1, 1989]. In addition, the American Conference of Governmental Industrial Hygienists (ACGIH) Threshold Limit Values (TLVs) comprised of time weighted averages (TLV-TWA), short term exposure limits (TLV-STEL) and ceiling limits (TLV-C) are recommended as a general guide for air contaminant exposure which should be met (see 13.2).

5. Uses and Limitations

5.1 The calibration of the method as presented here further restricts its use to amylases of bacterial origin.

5.2 Some surface active agents interfere with the color development which is an essential part of this method. The method is therefore not suitable for assessing the effect of surfactants on enzymes.

6. Apparatus

6.1 Comparator (see 13.3).

6.2 Water bath. Constant temperature $30 \pm 0.2^\circ\text{C}$.

6.3 Electric timer (see 13.4).

6.4 Glassware (see 13.5).

6.4.1 Borosilicate 13×100 mm test tubes—at least six dozen should be on hand.

6.4.2 Standard volumetric pipettes to deliver 2 mL, 5 mL, 10 mL, 20 mL, fast 1 mL blow-out pipette for sampling hydrolyzing mixture, plus assorted standard pipettes to accomplish necessary sample preparation dilutions.

7. Reagents

7.1 Iodine (crystalline); reagent grade; I_2

7.2 Potassium iodide; KI

7.3 Potassium dihydrogen phosphate;

Table I—Guide to Selection of Sample Weight

Sample alpha-amylase content (BAU per g)	Sample weight to be used mg sample per 10 mL final dilution
70-250	200
125-500	100
300-900	50
600-1800	25
1000-4000	10
3000-9000	5
6000-18000	2.5
12500-50000	1

KH_2PO_4 (monobasic)

7.4 Sodium phosphate; Na_2HPO_4 (dibasic)

7.5 Merck's Lintner Starch

8. Preparations

8.1 Test Sample Preparation.

8.1.1 Prepare the sample solution by dilution with water so that 10 mL of the final solution (see Table I) will give a dextrinizing time of 15-35 min. With dry samples, insoluble materials may be present but it is generally unnecessary to filter the solution.

8.1.2 Table I shows sample weight to be used with samples of varying alpha-amylase content. If the sample can be placed in either of two ranges, it is preferable to use the sample weight corresponding to the higher range since this will give a longer dextrinization time, making for easier and more accurate measurements.

8.1.3 Liquid products should be weighed as the specific gravity is usually greater than 1.0.

8.1.4 In all cases a sufficient amount of sample should be weighed to minimize weighing errors. If necessary, the amount of sample to be applied to the test may be obtained by secondary volume dilution.

8.2 Stock Iodine Solution.

8.2.1 Weigh in glass, 5.5 g reagent grade crystalline iodine; to dissolve, add 11 g reagent grade potassium iodine dissolved in minimum (10-12 mL) water. When iodine has completely dissolved dilute to 250 mL.

8.2.2 Preserve this solution in an amber glass-stoppered bottle and store under refrigeration. Solution may be used for three months.

8.3. Dilute Iodine Solution.

8.3.1 Dissolve 2.0 mL of stock iodine solution and 20 g reagent grade potassium iodide in water, and dilute to 500 mL.

8.3.2 The dilute iodine solution may be stored under refrigeration and used for one week. However, at the time of its use (see 9.1), it should be at $30 \pm 1^\circ\text{C}$.

8.4 Buffer Solution, pH 6.6.

8.4.1 Solution A. Dissolve 9.078 g of KH_2PO_4 in water and dilute to 1 L.

8.4.2 Solution B. Dissolve 9.472 g of Na_2HPO_4 in water and dilute to 1 L.

8.4.3 Mix 600 mL of Solution A and 400 mL of Solution B to obtain pH 6.6 buffer.

8.5 Buffered Starch Substrate.

8.5.1 Determine the dry weight of Merck's Lintner Starch (Special for Diastatic Power Determinations) by drying 20.00 g of starch at $103\text{--}104^\circ\text{C}$ for 3 h. Weigh after cooling in desiccator and continue drying until weight is constant. Discard after dry weight has been determined.

8.5.2 Calculate the amount of starch equivalent to 10.00 g dry basis for 500 mL starch substrate.

8.5.3 Starch should be retained in tightly closed jar and not exposed to environment where the moisture content would be subject to change.

8.5.4 Quantitatively transfer a slurry of 10.00 g (dry weight basis) of Merck's Lintner Starch into about 300 mL of vigorously stirred boiling water contained in a 1 L Pyrex beaker. Leave the stirring rod in the solution after boiling resumes and boil for exactly 3 min.

8.5.5 Cool to room temperature in a cold water bath with continuous stirring to avoid skin formation (surface dehydration).

8.5.6 Quantitatively transfer the starch into a 500 mL volumetric flask using a small quantity of water to complete the transfer.

8.5.7 Add 10 mL of pH 6.6 buffer and dilute to the mark.

8.5.8 Check the pH of the starch substrate with a standardized pH meter.

8.5.9 Starch substrate should be free of lumps or flakes and prepared fresh daily. Obviously contamination of the starch substrate with even minute traces of enzyme will render the substrate unsuitable for use.

9. Procedure

9.1 Dispense 5.0 mL dilute iodine solution in each of a series of test tubes and allow to temperate in the $30 \pm 1^\circ\text{C}$ bath.

9.2 Transfer 20.0 mL of buffered

starch substrate into a 50 mL Erlenmeyer (or equivalent) (lead rings are convenient to weight the flask), stopper, place in $30 \pm 1^\circ\text{C}$ bath allowing about 15 min to attain uniform temperature within the flask.

9.3 Likewise temperate an appropriate amount of freshly prepared sample solution. Rapidly add 10.0 mL of the sample solution, using a blow-out type pipette, and start the timer. After pipette has drained, replace rubber stopper and swirl flask vigorously to ensure proper mixing.

9.4 At appropriate time intervals, add 1 mL (blow-out pipette with cotton plug) of the hydrolyzing mixture to 5 mL of dilute iodine solution at $30 \pm 1^\circ\text{C}$, shake to mix thoroughly, pour into the 13 mm precision square tube, and compare with standard alpha-amylase color disc in the Hellige comparator. After completing the comparison, empty the square tube, giving it a quick shake so that very little liquid remains. The tube may now be used for another test.

9.5 During the initial stages of reaction, it is not necessary that the 1 mL sample be measured precisely before adding to the dilute iodine solution. As the end point is approached, the addition must be made accurately. The contents of the pipette are blown into the iodine solution in order that the time may be more accurately measured.

9.6 Around the time of the end point, samples should be taken every 0.5 min. In case two samples 0.5 min apart show that one is darker than the standard color and the other one is lighter, record the end-point time as the quarter minute between these two times.

9.7 Care must be exercised to avoid contact of the 1 mL hydrolyzing pipette with the dilute iodine solution. A carry-back of iodine to the hydrolyzing mixture will interfere with enzyme action.

10. Calculation

10.1 Calculate the alpha-amylase content of the sample by using the following equation:

$$\text{BAU per g} = 40(F)/T$$

10.2 Explanation of equation (see 13.1):

BAU = Bacterial Amylase Units per gram (g)

F = Dilution Factor (total dilution volume/sample weight in grams)

T = Dextrinizing time in minutes

10.3 The preceding equation follows from:

(a) the definition of the BAU as the quantity of enzyme that dextrinized one mg of starch per minute, and

(b) the assay practice of dextrinizing 400 mg of starch (20 mL of 2% solution) with a 10 mL aliquot of enzyme solution. Thus:

$$\text{BAU per gram} = 400/T \times F/10 = 40F/T$$

10.4 Example of Calculations:

10.4.1 If we assume that for a particular sample being tested the anticipated BAU/g is 800, reference to Table I indicates that 25 mg of sample per 10 mL of final dilution should be employed. Therefore, 2.5 g of the sample would be weighed out, and diluted to 1000 mL. It now becomes possible to calculate the Dilution Factor, F :

$$F = \text{Total Dilution Volume/Sample Weight in grams} = 1000/2.5 = 400$$

10.4.2 If the dextrinizing time is 20 min, the BAU/g can be calculated:

$$\begin{aligned} \text{BAU/g} &= 40 F/T = 40 \times 400/20 \\ &= 16000/20 = 800 \end{aligned}$$

10.4.3 If BAU does not fall within expected limits, a retest should include the practice of making up an entirely new sample preparation. This constitutes a check on the preparation of the test solution where errors may have occurred resulting in erroneous BAU.

11. Report

11.1 Report the amylase content of the sample as Bacterial Amylase Units (BAU) per gram.

12. Precision and Bias

12.1 *Precision.* The mean of duplicate tests should check within $\pm 6.5\%$ of the true mean at the 95% confidence level. This information is based on an interlaboratory study.

12.2 *Bias.* The values, Bacterial Assay Units (BAU), can only be defined in terms of a test method. There is no independent method for determining the true value. Based on the information available, the method has no known bias.

13. Notes

13.1 If approximate or anticipated BAU of material to be tested is known, determine dilution factor (F) by multiplying selected test time (T) by anticipated BAU and dividing by 40, thus: $T \times \text{BAU}/40 = F$.

13.2 Available from Publications Office, ACGIH, Kemper Woods Center, 1330 Kemper Meadow Dr., Cincinnati OH 45240; tel: 513/742-2020.

13.3 Comparator. One source of such equipment is Orbeco Analytical Systems Inc., 185-T Marine St., Farmingdale NY 11735-5656; tel: 516/293-4110. Order Hellige Alpha-Amylase Testing Outfit 606-55, include No. 605 Pocket Comparator with two No.

600-T13 Square Precision Tubes, No. 6208-5 Color Disk and directions, or equivalent comparator.

13.3.1 Light Source. Should be either daylight or daylight fluorescent lamps. Incandescent lamps should not be used since they give

slightly lower results.

13.4 Electric Timer Source. Time-It, manufactured by Precision Scientific Co., Chicago IL, calibrated in minutes and hundredths if convenient.

13.5 All glassware must be clean. This

applies particularly to pipettes where a hang-up of droplets interferes with correct volume delivery. Sulfuric acid-potassium dichromate cleaning solution is an efficient cleanser but must be thoroughly removed by repeated rinsing.

Colorfastness to Water Spotting

Developed in 1962 by AATCC Committee RA23; reaffirmed 1966, 1969, 1972, 1975, 1978, 1988, 1989, 1999; editorially revised and reaffirmed 1981, 1983, 1994, 2004. Technically equivalent to ISO 105-E07.

1. Purpose and Scope

1.1 This test method is designed to evaluate the resistance to water spotting of dyed, printed or otherwise colored textile fabrics.

1.2 The test method does not determine whether the discoloration is removable.

2. Principle

2.1 The test specimen is spotted with distilled or deionized water and evaluation is made of change of color, after wetting and after drying.

3. Terminology

3.1 **colorfastness**, n.—the resistance of a material to change in any of its color characteristics, to transfer of its colorant(s) to adjacent materials or both, as a result of the exposure of the material to any environment that might be encountered during the processing, testing, storage or use of the material.

4. Safety Precautions

NOTE: These safety precautions are for information purposes only. The precautions are ancillary to the testing procedures and are not intended to be all inclusive. It is the user's responsibility to use safe and proper techniques in handling materials in this test method. Manufacturers MUST be consulted for specific

details such as material safety data sheets and other manufacturer's recommendations. All OSHA standards and rules must also be consulted and followed.

4.1 Good laboratory practices should be followed. Wear safety glasses in all laboratory areas.

5. Apparatus and Materials

5.1 Glass rod.

5.2 AATCC Gray Scale for Color Change (see 11.1).

5.3 Pipette, graduated, 1 mL.

5.4 Distilled or deionized water.

6. Test Specimens

6.1 Colored cloth specimens, approximately 15.2 × 15.2 cm (6 × 6 in.).

7. Procedure

7.1 With tip of pipette in contact with cloth, run onto the specimen 0.15 mL water at room temperature. If necessary, work water in with a rounded glass rod to assist penetration.

7.2 Evaluate the change in color in the periphery of the spot after 2 min wetting and after drying at room temperature by use of the Gray Scale for Color Change.

8. Evaluation

8.1 Rate the effect on the color of the test specimens by the Gray Scale for Color Change (see 11.1).

Grade 5—negligible or no change as shown in Gray Scale Step 5.

Grade 4.5—change in color equivalent to Gray Scale Step 4-5.

Grade 4—change in color equivalent to Gray Scale Step 4.

Grade 3.5—change in color equivalent to Gray Scale Step 3-4.

Grade 3—change in color equivalent to Gray Scale Step 3.

Grade 2.5—change in color equivalent to Gray Scale Step 2-3.

Grade 2—change in color equivalent to Gray Scale Step 2.

Grade 1.5—change in color equivalent to Gray Scale Step 1-2.

Grade 1—change in color equivalent to Gray Scale Step 1.

9. Report

9.1 Report type of water and pH of water used for the test.

9.2 Report the grade for change in color after 2 min and after drying at room temperature.

10. Precision and Bias

10.1 *Precision*. Precision for this test method has not been established. Until a precision statement is generated for this test method, use standard statistical techniques in making any comparisons of test results for either *within-laboratory* or *between-laboratory* averages.

10.2 *Bias*. Colorfastness to water spotting can be defined only in terms of a test method. There is no independent method for determining the true value. As a means of estimating this property, the method has no known bias.

11. Note

11.1 Available from AATCC, P.O. Box 12215, Research Triangle Park NC 27709; tel: 919/549-8141; fax: 919/549-8933; e-mail: orders@aatcc.org.

Colorfastness to Water: Sea

Developed in 1962 by AATCC Committee RA23; revised 1967, 1968, 1972, 1981; reaffirmed 1975, 1978, 1989; editorially revised 1985, 1994, 2001, 2005; editorially revised and reaffirmed 1986, 1991, 1997, 2002. Partly equivalent to ISO 105-E02.

1. Purpose and Scope

1.1 This test method is designed to measure the resistance to sea water of dyed, printed, or otherwise colored textile yarns and fabrics of all kinds.

1.2 Artificial sea water is used in this test because natural sea water is variable in composition, and is often difficult to obtain.

2. Principle

2.1 The specimen, backed by multifiber test fabric, is immersed in artificial sea water under specified conditions of temperature and time, and then placed between glass or plastic plates under specified conditions of pressure, temperature and time. The change in color of the specimen and the staining of the attached multifiber test fabric are observed.

3. Terminology

3.1 **colorfastness, n.**—the resistance of a material to change in any of its color characteristics, to transfer of its colorant(s) to adjacent materials or both, as a result of the exposure of the material to any environment that might be encountered during the processing, testing, storage or use of the material.

4. Safety Precautions

NOTE: These safety precautions are for information purposes only. The precautions are ancillary to the testing procedures and are not intended to be all inclusive. It is the user's responsibility to use safe and proper techniques in handling materials in this test method. Manufacturers MUST be consulted for specific details such as material safety data sheets and other manufacturer's recommendations. All OSHA standards and rules must also be consulted and followed.

4.1 Good laboratory practices should be followed. Wear safety glasses in all laboratory areas.

4.2 All chemicals should be handled with care.

4.3 Manufacturer's safety recommen-

dations should be followed when operating laboratory testing equipment.

4.4 Observe padder safety. Ensure adequate guard at the nip point. Normal safeguards on pad should not be removed.

5. Apparatus and Materials

5.1 AATCC Perspiration Tester, Perspirometer or equivalent device (plastic or glass plates are available with the equipment) (see 12.1 and 12.2).

5.2 Drying oven—convection.

5.3 Multifiber test fabric No. 1 or No. 10 (see 12.1).

5.4 AATCC Chromatic Transference Scale (see 12.1).

5.5 AATCC Gray Scale for Color Change and Gray Scale for Staining (see 12.1).

5.6 Wringer (see 12.3).

6. Test Solution (Artificial Sea Water)

6.1 Per liter:
Sodium chloride (NaCl), tech. 30 g
Magnesium chloride (MgCl₂), anhyd. 5 g
Distilled water to make 1000 mL solution

7. Test Specimens

7.1 Colored specimens 60 × 60 mm ± 2 mm (2.25 × 2.25 in.) with multifiber test fabric attached to the technical face (see 12.1).

8. Procedure

8.1 Immerse the test specimen in the test solution at room temperature with occasional agitation to ensure thorough wetting out (approximately 15 min generally required for average fabrics) (see 12.4).

8.2 Remove the test specimen from the test solution and only pass between squeeze rolls (wringer) to remove excess liquor when the wet weight of the test specimen is more than 3 times its dry weight. Whenever possible, the wet weight should be 2.5-3.0 times the dry weight.

8.3 Place the test specimen between glass or plastic plates and insert in the specimen unit of the perspiration tester. Adjust the perspiration tester to produce a pressure of 4.5 kg (10.0 lb) on the test specimen (see 12.2).

8.4 Heat the loaded specimen unit in an oven at 38 ± 1°C (100 ± 2°F) for 18 h. Remove specimen from unit and complete drying by hanging in air at room

temperature. Do not press dry.

9. Evaluation Method for Color Change

9.1 Rate the effect on the color of the test specimens by the Gray Scale for Color Change (see 12.1).

Grade 5—negligible or no change as shown in Gray Scale Step 5.

Grade 4.5—change in color equivalent to Gray Scale Step 4-5.

Grade 4—change in color equivalent to Gray Scale Step 4.

Grade 3.5—change in color equivalent to Gray Scale Step 3-4.

Grade 3—change in color equivalent to Gray Scale Step 3.

Grade 2.5—change in color equivalent to Gray Scale Step 2-3.

Grade 2—change in color equivalent to Gray Scale Step 2.

Grade 1.5—change in color equivalent to Gray Scale Step 1-2.

Grade 1—change in color equivalent to Gray Scale Step 1.

10. Evaluation Method for Staining

10.1 Rate the staining of the multifiber test fabric (see 12.5) by the AATCC Chromatic Transference Scale or the Gray Scale for Staining. Report which classification scale is used (see 12.6).

Grade 5—negligible or no color transfer.

Grade 4.5—color transfer equivalent to Step 4-5 on the Gray Scale for Staining or Row 4.5 on the 9-step AATCC Chromatic Transference Scale.

Grade 4—color transfer equivalent to Step 4 on the Gray Scale for Staining or Row 4 on the 9-step AATCC Chromatic Transference Scale.

Grade 3.5—color transfer equivalent to Step 3-4 on the Gray Scale for Staining or Row 3.5 on the 9-step AATCC Chromatic Transference Scale.

Grade 3—color transfer equivalent to Step 3 on the Gray Scale for Staining or Row 3 on the 9-step AATCC Chromatic Transference Scale.

Grade 2.5—color transfer equivalent to Step 2-3 on the Gray Scale for Staining or Row 2.5 on the 9-step AATCC Chromatic Transference Scale.

Grade 2—color transfer equivalent to Step 2 on the Gray Scale for Staining or Row 2 on the 9-step AATCC Chromatic Transference Scale.

Grade 1.5—color transfer equivalent to Step 1-2 on the Gray Scale for Staining or Row 1.5 on the 9-step AATCC Chromatic Transference Scale.

Grade 1—color transfer equivalent to Step 1 on the Gray Scale for Staining or Row 1 on the 9-step AATCC Chromatic Transference Scale.

11. Precision and Bias

11.1 *Precision.* Precision for this test method has not been established. Until a precision statement is generated for this test method, use standard statistical techniques in making any comparisons of test results for either *within-laboratory* or *between-laboratory* averages.

11.2 *Bias.* Colorfastness to sea water can be defined only in terms of a test method. There is no independent method for determining the true value. As a means of estimating this property, the method has no known bias.

12. Notes

12.1 For procurement see listing under Special Equipment and Materials Used in AATCC Test Methods in the AATCC TECHNICAL MANUAL.

12.2 AATCC Perspiration Tester: Put all 21 glass or plastic plates into the unit regardless of the number of specimens. After the final glass or plastic plate is put in position on top, set the dual plates with compensating springs in position. Place a 3.6 kg (8.0 lb) weight on top making a total of 4.5 kg (10.0 lb) under the pressure plate. Lock the pressure plate in position by turning the thumb-screws. Remove the weight. Place the unit in the oven on its side, so that the plates and the specimens are vertical.

Perspirometer: The plates are held in a vertical position between an indicating scale with a fixed metal plate at one end and an adjustable metal plate at the other end. By means of adjusting screws, the movable plate may be

made to exert increasing pressure against the test specimens. When the desired pressure of 4.5 kg (10.0 lb) is indicated on the scale, lock the specimen unit by a set screw. The specimen unit can now be removed from the section applying the pressure. Another specimen unit may be added to the pressure section and the loading procedure repeated.

12.3 The Atlas Motorized Laboratory Wringer (see 12.1) and the Kenmore Hand Wringer #7326 (Sears, Roebuck & Co.) are suitable.

12.4 Or immerse the test specimen in the test solution at room temperature, pass through squeeze rolls (wringer) and reimmerse. Repeat, if necessary, to attain thorough wetting out.

12.5 Classify according to the fiber showing the greatest stain.

12.6 For very critical evaluations and in cases of arbitration, ratings must be based on the Gray Scale for Staining.

Colorfastness to Water

Developed in 1962 by AATCC Committee RA23; revised 1967, 1968, 1972, 1981; reaffirmed 1975, 1978, 1989; editorially revised 1983, 1985, 1994, 2001, 2005; editorially revised and reaffirmed 1986, 1991, 1997, 2002. Technically equivalent to ISO 105-E01.

1. Purpose and Scope

1.1 This test method is designed to measure the resistance to water of dyed, printed, or otherwise colored textile yarns and fabrics.

1.2 Distilled water or deionized water is used in this test method because natural (tap) water is variable in composition.

2. Principle

2.1 The specimen, backed by multifiber test fabric, is immersed in water under specified conditions of temperature and time, and then placed between glass or plastic plates under specified conditions of pressure, temperature and time. The change in color of the specimen and the staining of the attached multifiber test fabric are observed.

3. Terminology

3.1 **colorfastness**, *n.*—the resistance of a material to change in any of its color characteristics, to transfer of its colorant(s) to adjacent materials or both, as a result of the exposure of the material to any environment that might be encountered during the processing, testing, storage or use of the material.

4. Safety Precautions

NOTE: These safety precautions are for information purposes only. The precautions are ancillary to the testing procedures and are not intended to be all inclusive. It is the user's responsibility to use safe and proper techniques in handling materials in this test method. Manufacturers MUST be consulted for specific details such as material safety data sheets and other manufacturer's recommendations. All OSHA standards and rules must also be consulted and followed.

4.1 Good laboratory practices should be followed. Wear safety glasses in all laboratory areas.

4.2 Manufacturer's safety recommendations should be followed when operating laboratory testing equipment.

4.3 Observe padder safety. Ensure adequate guard at the nip point. Normal safeguards on pad should not be removed.

5. Apparatus and Materials

5.1 AATCC Perspiration Tester, Perspirometer or equivalent device (plastic or glass plates are available with the equipment) (see 12.1 and 12.2).

5.2 Drying oven—convection.

5.3 Multifiber test fabric No. 1 or No. 10 (see 12.1).

5.4 AATCC Chromatic Transference Scale (see 12.1).

5.5 AATCC Gray Scale for Color Change and Gray Scale for Staining (see 12.1).

5.6 Wringer (see 12.3).

6. Test Solution

6.1 Freshly boiled distilled water or deionized water from an ion-exchange device.

7. Test Specimens

7.1 Colored specimens 60 × 60 mm ± 2 mm (2.25 × 2.25 in.) with multifiber test fabric attached to the technical face (see 12.1).

8. Procedure

8.1 Immerse the test specimen in the test solution at room temperature with occasional agitation to ensure thorough wetting out (approximately 15 min generally required for average fabrics) (see 12.4).

8.2 Remove the test specimen from the test solution and only pass between squeeze rolls (wringer) to remove excess liquor when the wet weight of the test specimen is more than 3 times its dry weight. Whenever possible, the wet weight should be 2.5-3.0 times the dry weight.

8.3 Place the test specimen between glass or plastic plates and insert in the specimen unit of the perspiration tester. Adjust the perspiration tester to produce a pressure of 4.5 kg (10.0 lb) on the test specimen (see 12.2).

8.4 Heat the loaded specimen unit in an oven at 38 ± 1°C (100 ± 2°F) for 18 h. Remove specimen from unit and complete drying by hanging in air at room temperature. Do not press dry.

9. Evaluation Method for Color Change

9.1 Rate the effect on the color of the test specimens by the Gray Scale for Color Change (see 12.1).

Grade 5—negligible or no change as shown in Gray Scale Step 5.

Grade 4.5—change in color equivalent to Gray Scale Step 4-5.

Grade 4—change in color equivalent to Gray Scale Step 4.

Grade 3.5—change in color equivalent to Gray Scale Step 3-4.

Grade 3—change in color equivalent to Gray Scale Step 3.

Grade 2.5—change in color equivalent to Gray Scale Step 2-3.

Grade 2—change in color equivalent to Gray Scale Step 2.

Grade 1.5—change in color equivalent to Gray Scale Step 1-2.

Grade 1—change in color equivalent to Gray Scale Step 1.

10. Evaluation Method for Staining

10.1 Rate the staining of the multifiber test fabric (see 12.5) by the AATCC Chromatic Transference Scale or the Gray Scale for Staining. Report which classification scale is used (see 12.6).

Grade 5—negligible or no color transfer.

Grade 4.5—color transfer equivalent to Step 4-5 on the Gray Scale for Staining or Row 4.5 on the 9-step AATCC Chromatic Transference Scale.

Grade 4—color transfer equivalent to Step 4 on the Gray Scale for Staining or Row 4 on the 9-step AATCC Chromatic Transference Scale.

Grade 3.5—color transfer equivalent to Step 3-4 on the Gray Scale for Staining or Row 3.5 on the 9-step AATCC Chromatic Transference Scale.

Grade 3—color transfer equivalent to Step 3 on the Gray Scale for Staining or Row 3 on the 9-step AATCC Chromatic Transference Scale.

Grade 2.5—color transfer equivalent to Step 2-3 on the Gray Scale for Staining or Row 2.5 on the 9-step AATCC Chromatic Transference Scale.

Grade 2—color transfer equivalent to Step 2 on the Gray Scale for Staining or Row 2 on the 9-step AATCC Chromatic Transference Scale.

Grade 1.5—color transfer equivalent to Step 1-2 on the Gray Scale for Staining or Row 1.5 on the 9-step AATCC Chromatic Transference Scale.

Grade 1—color transfer equivalent to

Step 1 on the Gray Scale for Staining or Row 1 on the 9-step AATCC Chromatic Transference Scale.

11. Precision and Bias

11.1 *Precision.* Precision for this test method has not been established. Until a precision statement is generated for this test method, use standard statistical techniques in making any comparisons of test results for either *within-laboratory* or *between-laboratory* averages.

11.2 *Bias.* Colorfastness to water can be defined only in terms of a test method. There is no independent method for determining the true value. As a means of estimating this property, the method has no known bias.

12. Notes

12.1 For procurement see listings under Special Equipment and Materials Used in AATCC Test Methods in the AATCC TECHNICAL MANUAL.

12.2 AATCC Perspiration Tester: Put all 21 glass or plastic plates into the unit regardless of the number of specimens. After the final glass or plastic plate is put in position on top, set the dual plates with compensating springs in position. Place the 3.6 kg (8.0 lb) weight on top making a total of 4.5 kg (10.0 lb) under the pressure plate. Lock the pressure plate in position by turning the thumb-screws. Remove the weight. Place the unit in the oven on its side, so that the plates and the specimens are vertical.

Perspirometer: The plates are held in a vertical position between an indicating scale with a fixed metal plate at one end and an adjustable metal plate at the other end. By means of adjusting screws, the movable plate may be

made to exert increasing pressure against the test specimens. When the desired pressure of 4.5 kg (10.0 lb) is indicated on the scale, lock the specimen in it by a set screw. The specimen unit can now be removed from the section applying the pressure. Another specimen unit can be added to the pressure section and the loading procedure repeated.

12.3 The Atlas Motorized Laboratory Wringer (see 12.1) is suitable.

12.4 Or immerse the test specimen in the test solution at room temperature, pass through squeeze rolls (wringer) and reimmerse. Repeat, if necessary, to attain thorough wetting out.

12.5 Classify according to the fiber showing the greatest stain.

12.6 For very critical evaluations and in cases of arbitration, ratings must be based on the Gray Scale for Staining.

Colorfastness to Ozone in the Atmosphere under Low Humidities

Developed in 1963 by AATCC Committee RA33; revised 1972, 1986, 1987; reaffirmed 1971, 1975, 1983, 1992, 2002, 2005; editorially revised 1981, 1982, 1983, 1985, 1989, 1995; editorially revised and reaffirmed 1997. Partly equivalent to ISO 105-G03.

1. Purpose and Scope

1.1 This test method is intended for determining the resistance of the color of textiles to the action of ozone in the atmosphere at room temperatures with relative humidities not exceeding 67%.

2. Principle

2.1 A test specimen and a control specimen are simultaneously exposed to ozone in an atmosphere under ambient temperatures (64-82°F) and relative humidities not exceeding 67%, until the control specimen shows a color change corresponding to that of a standard of fading. This exposure period constitutes one cycle. The cycle is repeated (1) until the specimen shows a definite color change or (2) for a prescribed number of cycles.

3. Terminology

3.1 **colorfastness, n.**—the resistance of a material to change in any of its color characteristics, to transfer of its colorant(s) to adjacent materials or both, as a result of the exposure of the material to any environment that might be encountered during the processing, testing, storage or use of the material.

4. Safety Precautions

NOTE: These safety precautions are for information purposes only. The safety precautions are ancillary to the testing procedures and are not intended to be all inclusive. It is the user's responsibility to use safe and proper techniques in handling materials in this test method. Manufacturers MUST be consulted for specific details such as material safety data sheets and other manufacturer's recommendations. All OSHA standards and rules must also be consulted and followed.

4.1 Good laboratory practices should be followed. Wear safety glasses in all laboratory areas.

4.2 Manufacturer's safety recommendations should be followed when operating laboratory testing equipment. To pro-

tect the eyes further, do not look at ozone generator while it is operating.

4.3 Ozone is a sensory irritant. The test cabinet should be vented to the outside atmosphere in accordance with the manufacturer's specifications. Ozone in even moderate concentrations is injurious to health.

4.4 Exposure to chemicals used in this procedure must be controlled at or below levels set by governmental authorities (e.g., Occupational Safety and Health Administration's [OSHA] permissible exposure limits [PEL] as found in 29 CFR 1910.1000 of January 1, 1989). In addition, the American Conference of Governmental Industrial Hygienists (ACGIH) Threshold Limit Values (TLVs) comprised of time weighted averages (TLV-TWA), short term exposure limits (TLV-STEL) and ceiling limits (TLV-C) are recommended as a general guide for air contaminant exposure which should be met (see 12.1).

5. Uses and Limitations

5.1 Although this test works well for some substrates, it is not suitable for nylon carpets. For nylon carpets, refer to AATCC Method 129, Colorfastness to Ozone in the Atmosphere Under High Humidities.

6. Apparatus and Materials

6.1 Ozone exposure chamber for ambient temperatures and relative humidities not to exceed 67% (see 12.2).

6.2 Control Sample No. 109 for relative humidities not exceeding 67% (see 12.3, 12.5 and 12.6).

6.3 Standard of Fading No. 109 for relative humidities not exceeding 67% (see 12.4, 12.5 and 12.6).

6.4 Gray Scale for Color Change (see 12.7).

7. Test Specimens

7.1 Cut each test specimen at least 10.0 × 6.0 cm (4.0 × 2.375 in.). For subsequent color comparisons, keep the unexposed sample in an airtight container away from light to avoid shade change.

7.2 When a laundered or drycleaned specimen is used, the effects of ozone are based on comparisons with the color of the unexposed laundered or drycleaned specimen. To prepare specimens for testing after laundering or drycleaning, use AATCC Methods 61 and 132, respectively.

7.3 Cut a control specimen of the Control Sample at least 1.3 × 5.1 cm (0.5 × 2.0 in.).

7.4 Keep unexposed specimen in an airtight container away from light to avoid shade change.

8. Procedure

8.1 Suspend the test specimens and a control specimen (see 12.3 and 12.5) in the exposure chamber (see 12.2). The test apparatus should be located in a room in which the ambient air temperature is 18-28°C (64-82°F) and the relative humidity does not exceed 67%. For reference and interlab testing, conduct tests in a room or chamber with the standard atmospheric conditions of 21 ± 1°C (70 ± 2°F) and 65 ± 2% RH. Ozone should be present in concentrations which produce one cycle of fading in 1.5-6.0 h of test.

8.2 Examine the control specimen periodically until the resultant color corresponds to that of the standard of fading (see 12.4 and 12.5) when compared in daylight ranging from average to slightly bluish north sky light, or equivalent artificial light. This constitutes one cycle.

8.3 Remove those specimens which exhibit a color change at the end of one cycle. One cycle will generally produce a measureable color change in specimens which are ozone sensitive.

8.4 Suspend a fresh piece of the control specimen and continue exposure of any remaining specimens for a second cycle.

8.5 Run additional similar cycles as necessary.

9. Evaluation

9.1 At the end of each cycle immediately compare those specimens which are removed from the exposure chamber with the preserved originals from which they were drawn.

9.2 Rate the effect on color of test specimens after any specified number of cycles by reference to the Gray Scale for Color Change, and report the number of cycles run (see 12.10).

Grade 5—negligible or no change as shown in Gray Scale Step 5.

Grade 4.5—change in color equivalent to Gray Scale Step 4-5.

Grade 4—change in color equivalent to Gray Scale Step 4.

Grade 3.5—change in color equivalent to Gray Scale Step 3-4.

Grade 3—change in color equivalent to Gray Scale Step 3.

Grade 2.5—change in color equivalent to Gray Scale Step 2-3.

Grade 2—change in color equivalent to Gray Scale Step 2.

Grade 1.5—change in color equivalent to Gray Scale Step 1-2.

Grade 1—change in color equivalent to Gray Scale Step 1.

10. Report

10.1 Report the numerical grade for the change in color of each test specimen, the number of cycles run and the temperature and relative humidity at which the test was performed.

11. Precision and Bias

11.1 *Precision.* Precision for this test method has not been established. Until a precision statement is generated for this test method, use standard statistical techniques in making any comparisons of test results for either *within-laboratory* or *between-laboratory* averages.

11.2 *Bias.* Colorfastness to ozone in the atmosphere under low humidities can be defined only in terms of a test method. There is no independent method for determining the true values. As a means of estimating these properties, the method has no known bias.

12. Notes

12.1 Available from Publications Office, ACGIH, Kemper Woods Center, 1330 Kemper Meadow Dr., Cincinnati OH 45240; tel: 513/742-2020.

12.2 The ozone exposure chamber for room temperatures and relative humidities not exceeding 67% consists of an ozone generator, fan, baffle system, specimen rack and housing. Any form of an ozone generator may be used to produce the required concentration; however, ultraviolet light from mercury bulb generators or from spark-gap generators should be prevented from reaching the specimen on the rack by a suitable shield.

12.2.1 One form of generator makes use of a high voltage transformer discharge through a grid or ceramic tubes. The generator is placed in front of a low velocity fan which ejects ozone through a baffle system into the exposure chamber. The specimen rack consists of individual clamps to accommodate specimens of various sizes. Equipment is available from SDL Atlas L.L.C., 1813A Associate Lane, Charlotte NC 28217; tel: 704/329-0911; fax: 704/329-0914; e-mail: info@sdlatlas.com.

12.3 The control specimen for Lot 13 for tests made at room temperatures with relative humidities not exceeding 67% consists of a filament triacetate, woven ground fabric dyed with the following formula: 0.3% C.I. Disperse Yellow 42; 0.45% C.I. Disperse Red 35; 0.36% C.I. Disperse Blue 27 and 0.36% C.I. Disperse Blue 56.

12.4 The standard of fading for Lot 13 for tests made at room temperature with relative humidities not exceeding 67% is a filament triacetate fabric dyed with the following formula: 0.36% C.I. Disperse Yellow 86; 0.30% C.I. Disperse Red 35 and 1.65% C.I. Disperse Blue 27.

12.5 The control specimen and standard of fading for tests made at room temperatures with relative humidities not exceeding 67% are available from Testfabrics Inc., P.O. Box 26, 415 Delaware St., W. Pittston PA 18643; tel: 717/603-0432; fax: 717/603-0433; e-mail: testfabric@aol.com.

12.6 **Caution:** Both the control specimen

and the standard of fading must be kept in airtight containers to prevent color change encountered in normal atmospheres. In addition the control fabric is also sensitive to other atmospheric contaminants such as oxides of nitrogen. Its fading rate will vary considerably at different humidities and temperatures and its use in natural or end-use testing as a measure of exposure to ozone is not recommended. The color change produced on the controls will reflect the combined effects of the atmospheric contaminants present, temperature and humidity variations and not just the effects of exposure to ozone.

12.7 The Gray Scale is available from AATCC, P.O. Box 12215, Research Triangle Park NC 27709; tel: 919/549-8141; fax: 919/549-8933; e-mail: orders@aatcc.org.

12.8 For information regarding the measurement of ozone concentrations, see the following references:

Schulze, Fernand, "Versatile Combination Ozone and Sulfur Dioxide Analyzer," Analytical Chemistry 38, pp 748-752, May 1966.

"Selected Methods of the Measurement of Air Pollutants," Public Health Service Publication No. 999-AP-11, May 1965. Office of Technical Information and Publications (OTIP), Springfield VA. PB 167-677.

12.9 Apparatus for measuring ozone concentration is commercially available from several manufacturers including the following: Beckman Instrument Inc., 2500 Harbor Blvd., Fullerton CA 92634; and SDL Atlas L.L.C., 1813A Associate Lane, Charlotte NC 28217; tel: 704/329-0911; fax: 704/329-0914; e-mail: info@sdlatlas.com.

12.10 An automated electronic grading system may be used as long as the system has been demonstrated to provide results that are equal to and provide equal or better repeatability and reproducibility than an experienced grader performing visual evaluation.

Whiteness of Textiles

Developed in 1964 by AATCC Committee RA34; Jurisdiction transferred in 1983 to AATCC Committee RA36; reaffirmed 1968, 1972, 1975, 1979, 2000, 2005; editorially revised 1979, 1980; revised 1989 (title change), 1995; editorially revised and reaffirmed 1994. Technically equivalent to ISO 105-J02.

1. Purpose and Scope

1.1 This test method provides procedures for measuring the whiteness and tint of textiles.

1.2 Whiteness as measured by this test method is an indication of how white the textile appears to an average viewer. Tint, if other than zero, is an indication of a reddish or greenish hue having shifted away from a bluish hue with a dominant wavelength of 466 nm. The formulas for calculation of whiteness and tint are those recommended by the CIE (see 11.1).

1.3 Because reflectance is affected by the nature of the surface of the textile, comparisons can be made only between samples of the same type of textile.

1.4 The application of the formulas is restricted to specimens that are called "white" commercially, that do not differ much in color and fluorescence, and that are measured on the same instrument at nearly the same time. Within these restrictions, the formulas provide relative, but not absolute, evaluations of whiteness that are adequate for commercial use, when employing measuring instruments having suitable modern and commercially available capabilities.

2. Principle

2.1 The CIE tristimulus values are measured using a reflectance spectrophotometer or colorimeter, and the whiteness and tint calculated from formulas based on the CIE chromaticity coordinates.

2.2 Many impurities in textiles absorb short wavelength light, resulting in a yellowish appearance to observers. Therefore, a measurement of whiteness may be an indication of the degree to which a textile is free from impurities.

2.3 The presence of blueing components or fluorescent whitening agents (FWAs) in textiles may also be determined using the whiteness measurement.

3. Terminology

3.1 **CIE chromaticity coordinates**, n.—the ratio of each of the tristimulus values

of a psychophysical color to the sum of the tristimulus values (see 11.1) [ASTM E 284].

3.2 **CIE tristimulus values**, n.—amounts of three non-real reference color stimuli required to give a color match with the color stimulus considered, and defined by the CIE for the CIE 1931 standard observer and the CIE 1964 supplementary standard observer and for a particular illumination condition (see 11.1).

3.3 **fluorescent whitening agent (FWA)**, n.—colorant that absorbs near ultraviolet (UV) radiation and re-emits visible (violet-blue) radiation. This causes a yellowish material to which it has been applied to appear whiter. [ASTM E 284].

3.4 **perfect reflecting diffuser**, n.—ideal reflecting surface that neither absorbs nor transmits light, but reflects diffusely, with the radiance of the reflecting surface being the same for all reflecting angles, regardless of the angular distribution of the incident light. [ASTM E 284].

NOTE: The perfect reflecting diffuser is the basis of calibration of reflectance measuring instruments. The equations for whiteness and tint are formulated so that the CIE concept of the perfect reflecting diffuser has a whiteness index of 100.0 and a tint value of 0.0.

3.5 **tint**, n.—in *whiteness measurement*, the hue of a white material as influenced by the wavelength of peak emission or reflectance. [CIE 15.2].

3.6 **whiteness**, n.—whiteness is the attribute by which an object color is judged to approach a preferred white. [ASTM E 284].

4. Safety Precautions

NOTE: These safety precautions are for information purposes only. The safety precautions are ancillary to the testing procedures and are not intended to be all inclusive. It is the user's responsibility to use safe and proper techniques in handling materials in this test method. Manufacturers MUST be consulted for specific details such as material safety data sheets and other manufacturer's recommendations. All OSHA standards and rules must also be consulted and followed.

4.1 Good laboratory practices should be followed. Wear safety glasses in all laboratory areas.

4.2 CAUTION: Protect the eyes from UV light. The safety recommendations provided by the UV light manufacturer should be followed.

4.3 Manufacturer's safety recommen-

dations should be followed when operating laboratory testing equipment.

5. Apparatus and Materials

5.1 **Color Measuring Instrument**. A reflectance spectrophotometer or colorimeter capable of measuring or calculating CIE tristimulus values with at least one of the CIE specified geometries (45/0, 0/45, diffuse/0, 0/diffuse). When integrating spheres are used for measuring fluorescent specimens, the spectral power distribution of the illuminating system is altered by the reflected and emitted power from the specimen. The use of the 45/0 or 0/45 condition is therefore preferable (see 11.1).

5.2 **Reference Standard**. The primary standard is the perfect reflecting diffuser (see 3.4). Secondary Reference Standards are standards that are calibrated in terms of the perfect reflecting diffuser and are used in the standardization of the instrument.

5.3 **UV Lamp**. Used for visual determination of presence of FWA on textile specimens.

6. Test Specimen

6.1 Condition each specimen for several hours in an atmosphere of $21 \pm 1^\circ\text{C}$ ($70 \pm 2^\circ\text{F}$) and $65 \pm 2\%$ RH by layering each test specimen separately on a screen or perforated shelf of a conditioning rack (see ASTM D 1776, Standard Practice for Conditioning and Testing Textiles, and 11.5). Keep the samples free of dirt and stains. The exact size necessary will depend on the aperture of the reflectance measuring instrument used and on the translucency of the textile material.

7. Procedure

7.1 Before proceeding with color measurements, determine whether or not a fabric contains FWA by viewing a specimen in a dark room under ultraviolet light. A fabric that contains FWA will fluoresce under the UV light.

7.1.1 If fluorescent whitening agents (FWA) are present on the textile material, the measurement must be made with an instrument that illuminates the specimen with polychromatic light (full spectrum) and has a relative spectral power distribution approximating CIE illuminant D_{65} from 330-700 nm (see 11.3). Consult instrument manufacturers for suitable equipment. The user should also verify the suitability of the instrument if flash il-

lumination is being used.

7.1.2 For the determination of an approximate relative efficiency of an FWA, an instrument which permits the insertion of an ultraviolet cut-off filter into the incident light beam may be used. The difference between the measurements taken before and after the insertion of the ultraviolet cut-off filter can provide an indication of the enhancement of the apparent whiteness due to the addition of an FWA. Because of possible variations in light sources and/or ultraviolet cut-off filters, the user is cautioned to use this procedure only for "relative in-house" determination.

7.2 Operate the color measuring instrument according to the manufacturer's instructions for standardization and measurement, in accordance with AATCC Evaluation Procedure 6, Instrumental Color Measurement.

8. Calculations, Interpretation and Limitations

8.1 Average the measurement values taken for each test sample.

8.2 For each averaged measurement, determine the CIE tristimulus values X_{10} , Y_{10} and Z_{10} for CIE standard illuminant CIE D_{65} and 1964 10° observer (see ASTM Standard Practice E 308 for details on calculation of tristimulus values from reflectance data). Determine the chromaticity coordinates x_{10} , y_{10} . If the instrument used is not capable of calculating CIE illuminant D_{65} and 1964 10° observer, the user may use CIE illuminant C and 1931 2° observer method as described in 11.3.

8.3 The whiteness index (W_{10}) for any sample shall be calculated by the equation in 8.4 and the tint ($T_{W,10}$) by the equation in 8.5. Due to the limitations of instruments and the linearities of CIE whiteness space, comparisons of whiteness and tint values should only be made when measuring similar samples at nearly the same time and on the same instrument. The degree of difference that will be accepted or rejected is the sole responsibility of the user, as the requirements are extremely dependent on the particular use and material being measured. The higher the value of W_{10} , the greater the whiteness. Equal differences in W_{10} value do not necessarily indicate equal differences in perceived whiteness nor equal concentration differences of FWA. Similarly, equal differences in $T_{W,10}$ value do not always represent equal

perceptual differences in greenness or redness of whites.

8.4 Whiteness (see 11.2 and 11.3). (For illuminant D_{65} and 1964 10° observer):

$$W_{10} = Y_{10} + 800(0.3138 - x_{10}) + 1700(0.3310 - y_{10})$$

where W_{10} is the whiteness value or index; Y_{10} , x_{10} , y_{10} are the chromaticity coordinates of the specimen, and 0.3138 and 0.3310 are, respectively, the x_{10} , y_{10} chromaticity coordinates for the perfect diffuser.

Limited to: $40 < W_{10} < 5Y_{10} - 280$.

8.5 Tint (for illuminant D_{65} and 1964 10° observer):

$$T_{W,10} = 900(0.3138 - x_{10}) - 650(0.3310 - y_{10})$$

where $T_{W,10}$ is the tint value; x_{10} , y_{10} are the chromaticity coordinates of the sample, and 0.3138 and 0.3310 are, respectively, the x_{10} , y_{10} chromaticity coordinates for the perfect diffuser.

Limited to: $-3 < T_{W,10} < +3$.

Values of $T_{W,10}$, when positive, indicate a greenish hue; when negative, indicate a reddish hue; and when zero, indicate a bluish hue with a dominant wavelength of 466 nm.

9. Report

9.1 Report the numerical whiteness value, the tint value if required, the illuminant and observer used in the calculations, and the instrument used.

10. Precision and Bias

10.1 *Precision.* Precision for this test method has not been established. Until a precision statement is generated for this test method, use standard statistical techniques in making any comparisons of test results for either *within-laboratory* or *between-laboratory* averages.

10.2 *Bias.* The whiteness and tint of textiles can be defined only in terms of a test method. There is no independent method for determining the true values. As a means of estimating these properties, the method has no known bias.

11. Notes and References

11.1 For a description of the CIE colorimetric system, instrument geometry and a complete description of the whiteness and tint formulas used above, see Publication CIE No. 15.2 (1986), *Colorimetry, Second Edition*, available from USNC/CIE Publications, Attn: Thomas Lemons, TLA-Lighting Consultants,

7 Pond St., Salem MA 01970-4893.

11.2 The equation used in prior versions of this test method was:

$$W = 4B - 3G \text{ (AATCC Method 110-1979)}$$

where W = Whiteness, B = Blue reflectance and G = Green reflectance for CIE illuminant C and CIE 1931 2° standard observer.

11.3 Tristimulus colorimeters typically do not conform to CIE illuminant D_{65} and the CIE 1964 10° observer. Most produce calculations for CIE illuminant C and the CIE 1931 2° observer. Although the CIE Publication 15.2 recognizes whiteness and tint calculations for the CIE 1931 2° observer, it does not recognize calculations for the CIE illuminant C. Therefore, the following equations are given for those users of tristimulus colorimeters that have no other choice but to perform calculations for illuminant C and the 1931 2° observer. Bear in mind, however, these calculations are to be used only for "relative in-house" measurements and comparisons.

Whiteness (For illuminant C and 1931 2° observer):

$$W_{c,2} = Y + 800(0.3101 - x) + 1700(0.3161 - y)$$

where $W_{c,2}$ is the whiteness value or index, Y , x , y are the chromaticity coordinates of the specimen and 0.3101 and 0.3161 are, respectively, the x , y chromaticity coordinates for the perfect diffuser.

Limited to: $40 < W_{c,2} < 5Y - 280$.

Tint (For illuminant C and 1931 2° observer):

$$T_{c,2} = 1000(0.3101 - x) - 650(0.3161 - y)$$

where $T_{c,2}$ is the tint value; x , y are the chromaticity coordinates of the specimen, and 0.3101 and 0.3161 are, respectively, the x , y chromaticity coordinates for the perfect diffuser.

Limited to: $-3 < T_{c,2} < +3$.

Values of $T_{c,2}$, when positive, indicate a greenish hue; when negative, indicate a reddish hue; and when zero, indicate a bluish hue with a dominant wavelength of 466 nm.

11.4 Users who wish to explore the prediction of data under true D_{65} illuminant for samples containing FWAs can refer to the following: F. W. Billmeyer Jr., Metrology, Documentary Standards, and Color Specifications for Fluorescent Materials, *Color Research and Application*, 19, 413-425, (1994), and Publication CIE No. 51, *A Method for Assessing the Quality of Daylight Simulators for Colorimetry*.

11.5 References made to ASTM Standard Test Methods and Practices may be found in *ASTM Standards on Color and Appearance Measurement, Fourth Edition*, 1994, ASTM, 100 Barr Harbor Dr., West Conshohocken PA 19428; tel: 610/832-9500; fax: 610/832-9555.

11.6 For a more complete description of the proper procedures in color measurement, refer to AATCC TECHNICAL MANUAL, Evaluation Procedure 6, Instrumental Color Measurement.

Weather Resistance of Textiles: Exposure to Daylight and Weather

Developed in 1996 by AATCC Committee RA64 to supersede 111A-1990, 111B-1990, 111C-1990 and 111D-1990 originally developed in 1964 and last revised/reaffirmed in 1990; revised 2003 (with title change).

1. Purpose and Scope

1.1 This test method provides a means for determining the weather resistance of textile materials.

1.2 The test options described below are applicable to fibers, yarns and fabrics and products made therefrom, including coated fabrics, whether natural, colored, finished or unfinished. Test options included are:

Option A—Direct Exposure to Natural Light and Weather

Option B—Behind Glass Exposure to Natural Light and Weather without Direct Wetting

1.3 This test method contains the following sections that assist in the use and implementation of the various options for determining the weather resistance of textiles.

	Section
Principle	2
Terminology	3
Safety Precautions	4
Uses and Limitations	5
Apparatus and Materials	6
Calibration and Verification	7
Test Specimen Preparation	8
Test Specimen Mounting	8.1
Conditioning	9
Procedure	10
Evaluation	11
Report	12
Precision and Bias	13
References	14
Notes	15
Specimen Size and Preparation	Table I
Break Strength Components of Variance	Table II
Color Rating Components of Variance	Table III
Break Strength Critical Differences	Table IV
Color Rating Critical Differences	Table V
Daylight Exposure, Apparatus	Appendix A

2. Principle

2.1 Test specimens and the agreed upon comparison standard(s) are exposed simultaneously to natural weathering, ei-

ther Directly or Behind Window Glass, either to a specified degree of degradation such as color change, strength loss, etc., or alternately to a specific amount of radiant energy. Exposures can be timed by calendar days, months, or years as well. However, this method can result in more variation when comparing test exposures for equal duration at different time periods. The weather resistance of the material is determined by the exposed portion of the test specimens to an unexposed counterpart, using one or more of the procedures recommended in this test method.

3. Terminology

3.1 **AATCC Blue Wool Lightfastness Standard**, n.—one of a group of dyed wool fabrics distributed by AATCC for use in determining the amount of light exposure of specimens during lightfastness testing.

3.2 **Black Panel Thermometer**, n.—a temperature measuring device, the sensing unit of which is coated with black designed to absorb most of the radiant energy encountered in lightfastness testing.

3.3 **breaking strength**, n.—the maximum force applied to a specimen in a tensile test carried to rupture.

3.4 **broad bandpass radiometer**, n.—a relative term applied to radiometers that have a bandpass width of more than 20 nm at 50% of maximum transmittance and can be used to measure irradiance at wavelengths such as 300-400 nm or 300-800 nm.

3.5 **bursting strength**, n.—the force or pressure required to rupture a textile by distending it with a force applied at right angles to the plane of the fabric, under specified conditions.

3.6 **center wavelength**, n.—the specified wavelength midway between the half power points, for example, 340 nm \pm 2 nm.

3.7 **color change**, n.—a change in color of any kind whether in lightness, hue or chroma or any combination of these, discernible by comparing the test specimen with a corresponding untested specimen. Source: Evaluation Procedures 1 and 7.

3.8 **half-power bandpass**, n.—the interval between wavelengths at which transmittance is 50% of peak transmittance in a bandpass filter. NOTE: The interval should not exceed 20 nm for a narrow bandpass filter.

3.9 **irradiance**, n.—radiant power per unit area as a function of wavelength ex-

pressed as watts per square meter, W/m².

3.10 **irradiation**, n.—the time integral of irradiance expressed in joules per square meter (J/m²).

3.11 **laboratory sample**, n.—a portion of material taken to represent the lot sample, or the original material, and used in the laboratory as a source of test specimens.

3.12 **narrow bandpass radiometer**, n.—a relative term applied to radiometers that have a bandpass width of 20 nm or less at 50% of maximum transmittance and can be used to measure irradiance at wavelengths such as 340 or 420, \pm 0.5 nm.

3.13 **pyranometer**, n.—a radiometer used to measure the global solar irradiance or if inclined, hemispherical solar irradiance.

3.14 **radiant energy**, n.—energy traveling through space in the of photons or electromagnetic waves of various lengths.

3.15 **radiant exposure**, n.—time integral of irradiance.

3.16 **radiant flux density**, n.—rate of flow of radiant energy past the specimen.

3.17 **radiant power**, n.—energy per unit time emitted transferred or received as radiation.

3.18 **radiometer**, n.—an instrument used to measure radiant energy.

3.19 **reference fabric**, n.—one or more blue wool lightfastness standards selected for exposure as a check on a test apparatus and operating conditions.

3.20 **specimen**, n.—a specific portion of a material or a laboratory sample upon which a test is performed or which is selected for that purpose.

3.21 **spectral energy distribution**, n.—the variation of energy due to the source over the wavelength span of the emitted radiation.

3.22 **spectral transmittance**, n.—the percent of incident radiant energy passing through a given material and not absorbed in the process, as a function of wavelength.

3.23 **standard atmosphere for testing textiles**, n.—air maintained at 21 \pm 1°C (70 \pm 2°F) and 65 \pm 2% relative humidity.

3.24 **tearing strength**, n.—the average force required to continue a tear previously started in a fabric.

3.25 **ultraviolet radiation**, n.—radiant energy for which the wavelengths of the monochromatic components are smaller than those for visible radiation and more than about 100 nm.

NOTE: The limits of the spectral range

of ultraviolet radiation are not well defined and may vary according to the user. Committee E-2.1.2 of the CIE distinguishes in the spectral range between 400 and 100 nm:

UV-A	315-400 nm
UV-B	280-315 nm
UV-C	100-280 nm

3.26 **visible radiation**, n.—any radiant energy capable of causing a visual sensation.

NOTE: The limits of the spectral range visible radiation are not well defined and may vary according to the user. The lower limit is generally taken between 380 and 400 nm and the upper limit between 760 and 780 nm (1 nanometer, 1 nm = 10⁻⁹ m).

3.27 **weather**, n.—climatic conditions at a given geographic location, including such factors as sunlight, rain, humidity and temperature.

3.28 **weather resistance**, n.—ability of a material to resist degradation of its properties when exposed to climatic conditions.

4. Safety Precautions

NOTE: These safety precautions are for information purposes only. The precautions are ancillary to the testing procedures and are not intended to be all inclusive. It is the user's responsibility to use safe and proper techniques in handling materials in this test method. Manufacturers MUST be consulted on specific details such as material safety data sheets and other manufacturer's recommendations. All OSHA standards and rules must also be consulted and followed.

4.1 Daylight exposure of the skin and eyes for prolonged periods may be hazardous; therefore, caution should be employed to protect these areas. Do not look directly at the sun under any circumstances.

5. Uses and Limitations

5.1 The use of these options does not imply, expressly or otherwise, an accelerated test for a specific application. The degree of correlation between any weather resistance test and the actual exposure in use must be determined mathematically and agreed upon by the contractual parties.

A. Uses

5.2 Option A is intended for use in evaluating the resistance to degradation of a textile and related material, including coated fabrics, when subjected to natural weathering including wetting, and radiant energy factors, and are further intended to check the level of durability represented in a material specification. Option B is

intended for use in evaluating the resistance to degradation due to weathering and sunlight exposure under the milder conditions of a protected atmosphere, such as found in indoor environments, where wetting is not a factor and also milder due to reduction in short wavelength UV radiation by the glass.

5.3 The test option selected should reflect expected end-use conditions associated with the material to be tested.

5.4 When using this test method, use a standard of comparison. This comparison material should have a known history in terms of a change in property value after a specific exposure.

B. Limitations

5.5 Not all materials are affected equally by the same light source and environment. Results obtained by the use of any one test option may not be representative of those of any other test option or any end-use application unless a mathematical correlation for a given material or a given application has been established between contractual parties.

5.6 In interpreting the results of these test options, consider that resistance to degradation under simulated actual sunlight exposure is dependent upon such factors as:

5.6.1 The inherent properties of the material, its physical state, mass and compactness.

5.6.2 Spectral energy distribution and density of the radiant flux (from the sun).

5.6.3 The temperature and relative humidity of the air around the textile specimen during exposure.

5.6.4 The effect of leaching or degradation of additive products, including fiber stabilizers, by rain.

5.6.5 Atmospheric contaminants.

5.7.6 The action of additive finishes and colorants including spectral absorption characteristics.

5.6.7 Where applicable, the action of residual laundry or drycleaning chemicals.

5.7 The relative rates of degradation of different textile materials do not necessarily change to the same degree as those factors themselves change. Consequently, the relative durability of textile and related materials under the varying conditions of use cannot be predicted with certainty with any one test. Therefore, it is common practice to investigate the durability of materials by exposure to the variety of conditions under which they can be used to arrive at a full understanding of the performance that can be expected from them.

5.8 Variations in results may be expected when operating conditions are varied within the accepted limits of this method, or tests are conducted in different geographical locations. Therefore, no

reference shall be made to results from the use of this method unless accompanied by a report detailing the specific operating conditions and locations in conformance with Section 12.

6. Apparatus and Materials

6.1 Daylight Exposure Rack that allows wetting by rainfall (see 15.6 and ASTM G 24).

6.2 Behind Glass Daylight Exposure Cabinet that is glass covered and does not allow wetting by natural rainfall (see Appendix A and ASTM G 24, Type A).

6.3 Black Panel Thermometer.

6.4 Pyranometer (see 15.7 and 15.9).

6.5 UV Radiometer (see 15.7 and 15.9).

6.6 RH Sensor.

6.7 Blue Wool Standards (see AATCC Method 16, 14.2.1).

7. Maintenance and Verification

7.1 Maintain in accordance with the manufacturer's instructions. For the Behind Glass Daylight Exposure Cabinet, wash both the exterior surface and the interior surface of the glass cover monthly (or more frequently, if required) to remove dust particles and other undesirable material.

8. Test Specimen Preparation

8.1 Prepare specimens for the specified test procedures of at least the size given in Table I. When applicable, cut specimens with the longer direction parallel to the warp or filling direction as required in a material specification or contract order (see 15.5).

8.1.1 Prepare specimens as required to meet the needs of the applicable test method given in Table I (see 15.3, 15.4, and 15.5).

8.1.2 These dimensions are given as a general guide and in most cases will be adequate to perform the required evaluation. Certain materials may exhibit a dimensional change with respect to the exposure. The test equipment manufacturer, physical test apparatus and number of specimens required will affect the needed specimen size. In any event, the test procedures given in Table I should be reviewed to ensure sufficient specimens are exposed for individual needs.

8.1.3 Unless otherwise specified, test specimens shall be a maximum thickness of 25 mm (1 in.). For specimens over 25 mm (1 in.) thick, formed or configured specimens, and large components, specific instructions must be agreed upon between the purchaser and the supplier.

8.1.4 When required to prevent raveling, the specimens may be edged using a flexible epoxy resin or similar material, or by sewing, pinking or fusing.

Table I—Specimen Size and Preparation

Property	Test Method	Specimen Size
Breaking Strength:		
Strip Test	ASTM D 5035	5 × 20 cm (2 × 8 in.)
Grab Test	ASTM D 5034	13 × 28 cm (5 × 7 in.)
Single Strand	ASTM D 2256	15 cm (6 in.)
Bursting Strength:		
Woven Fabric	ASTM D 3786	15 × 15 cm (6 × 6 in.)
Nonwoven Fabric	ASTM D 3786	15 × 15 cm (6 × 6 in.)
Knit Fabric	ASTM D 3787	15 × 15 cm (6 × 6 in.)
Test Strength:		
Elmendorf	ASTM D 1424	10 × 13 cm (4 × 5 in.)
Trapezoid	ASTM D 5587	10 × 18 cm (4 × 7 in.)
Colorfastness	AATCC 16	3 × 6 cm (1.25 × 2.4 in.)

8.1.5 Labeling each specimen is preferred to provide a record of the changes encountered at different radiant exposure levels. Retain an unexposed specimen for comparison to the exposed specimen.

8.2 Mounting

8.2.1 For **Options A and B**. To more closely simulate specific end-use conditions, the cabinet backing materials shown below have been found to be acceptable:

Cabinet Backing Materials

End-Use	Cabinet Backing	Approximate Temperatures
Automotive	Solid (Plywood)	82°C (180°F)
Household (Drapery, etc.)	Expanded Metal	63°C (145°F)
Clothing and Sensitive Materials	None (Open)	43°C (110°F)
Fabric Roof Structures	None (Open)	43°C (110°F)

8.2.2 **Fabrics.** Secure the specimens to the frames to hold them smoothly without curling of the edges. Fabrics may be stitched to gauze backing. For colorfastness determinations, mount the specimens in frames as directed in AATCC Method 16, Colorfastness to Light.

8.2.3 **Yarns.** Wind yarns on frames. Only that portion of the yarns directly facing the radiant energy is tested for breaking strength. Single strand or multiple strand testing is performed. When multiple strand testing may be performed, the yarns are wound on the frame closely packed to 2.5 cm (1.0 in.) width. The control specimens must contain the same number of strands as the specimen subjected to exposure. After the exposure has been completed and before the yarns are removed from the frame for testing, those yarns facing the light source are bound together using 2.0 cm (0.75 in.) wide masking or other suitable tape to maintain the closely packed arrangements on the exposure frame.

9. Conditioning

9.1 When the exposure cycle is completed, remove the test and control specimens from the exposure rack and transfer them to a standard atmosphere [air maintained at 21 ± 1°C (70 ± 2°F) and 65 ± 2% relative humidity] for testing textiles for conditioning.

9.2 If the specimens are wet upon removal from the racks, dry them at ambient laboratory conditions or at a temperature not exceeding 71°C (160°F) before placing them in the conditioning atmosphere. The unexposed reference standard (comparison standard) and the retained unexposed original should be treated under exactly that same conditions of drying and conditioning as the test specimens.

9.3 Bring all specimens, control and test, to moisture equilibrium in the standard atmosphere for testing textiles. Equilibrium is considered to have been reached when the increase in mass of the specimen in successive weightings made at intervals of not less than 2 h does not exceed 0.1% of the mass of the specimen. In general practice, the industry approaches equilibrium from the “as received” side.

9.3.1 It is recognized that, in practice, textile materials are frequently not weighed to determine when moisture equilibrium has been reached. While such a procedure cannot be accepted in cases of dispute, it may be sufficient in routine testing to expose the material to the standard atmosphere for testing for a reasonable period of time before the specimens are tested. Twenty-four hours has been found acceptable in most cases; however, certain fibers may exhibit slow moisture equalization rates from the “as received” “wet side.” When this is known, a preconditioning cycle, as described in ASTM Practice D 1776, Standard Practice for Conditioning and Testing Textiles (see 14.1.12) may be agreed upon between contractual parties.

9.4 For each test to be made on the test

material and control, exposed and unexposed, prepare test specimens by marking and raveling or cutting the central portion of each exposed specimen to the dimensions specified in the respective test methods given in Table I. The marking and raveling or cutting of the test specimens is preferred after the exposure but may be done before exposure. Control specimens not exposed are similarly prepared. For samples exposed with wetting, control specimens are wet-out and allowed to dry without tension before testing. All specimens, control and test, are conditioned simultaneously to the standard atmosphere for testing textiles for a minimum of 24 h and preferably longer, depending upon the material, and tested at the same time.

10. Procedure

10.1 Mount on the exposure rack the appropriate number of replicates (see Section 8) of the specimens as required to average out variability and to ensure accuracy of results and the necessary number of replicates of the standard, when such are available. The specimens shall be so positioned as to avoid shadowing of the specimens at the sides of the cabinet.

10.2 Expose the specimens to sunlight and the general elements of weather for a prescribed period of time during which period the radiant energy may be recorded, or when a prescribed amount of radiant exposure has been attained as determined by an applicable specification (see 15.7).

10.2.1 **For Option A, Direct Exposure to Daylight and Weathering,** use Direct Exposure Rack described in Section A2 of Appendix A.

10.2.2 **For Option B, Behind Glass Exposure to Natural Light without Wetting,** use cabinet described in Section A3 of Appendix A. Ensure that the face of the exposed standard(s) and test specimen(s) are at least 7.5 cm (3 in.) below the inside surface of the glass cover and are positioned at least 15 cm (6 in.) in from the edges of the glass frame. The back of the exposure cabinet may be varied as follows to achieve the required exposure conditions:

Backing	Exposure Condition
Open	Low Temperature
Expanded Metal	Medium Temperature
Solid	High Temperature

10.3 Expose standard(s) and specimen(s) 24 h a day and remove for inspection or for physical properties testing.

10.4 Monitor temperature and relative humidity in the vicinity of the test cabinets or racks.

10.5. Conduct physical test using the test methods listed in Section 14, as applicable.

10.5.1 Average the data for the various replicates, or handle statistically as appropriate, and record the value of breaking, tearing, or bursting strength retention and/or colorfastness after exposure in relation to original strength or color, as applicable. It is appropriate to record the percent elongation characteristics of the unexposed controls and exposed specimens at rupture or at some prescribed point in the force-elongation curve as this is frequently significant supplementary information.

11. Evaluation

11.1 Classify the durability or resistance to degradation of the material with respect to the standard of comparison by one of the following:

11.1.1 *Percent Strength Retained or Percent Strength Loss.* Record percent strength loss or percent strength retained (breaking, tearing, or bursting as appropriate) of the material after the prescribed exposure time period.

11.1.2 *Residual Strength.* Record the initial and final strength values along with all other pertinent data as above.

11.1.3 *Colorfastness.* Classify the colorfastness of the material as directed in AATCC Method 16, Option 6.

11.1.4 *In Terms of an Agreed upon Comparison Sample or Standard.* Durability of the sample in terms of the standard is determined by the following: As *durable* or *more durable* than the comparison sample at the amount of radiant exposures and/or exposure time period prescribed in the material standard; or *less durable* than the comparison sample at the amount of radiant exposure and/or exposure time period prescribed in the material standard.

11.1.5 For the purpose of defining the relative durability of a test material to an agreed upon comparison standard an index, S_nX , defined as the ratio of the per-

cent residual strength in the tested specimen to that of the untested material, may be used. With the index a specimen is considered to be as resistant to degradation as the standard when the S_nX value is 1; more durable when the S_nX index exceeds 1; less durable when the S_nX index is less than 1.

NOTE: An index of this nature has particular value when recording the relative durability of a series of materials to a common standard and can be actually more useful in research than in the routine assessment of the durability of materials for purpose of commerce.

12. Report

12.1 Use the guide below and report all applicable information:

12.2 Report any deviation from Test Method 111 or the performance of the comparison standard.

12.3 Report all information in 12.1 for the same conditions that the samples and reference materials are exposed.

12.4 Report all applicable properties evaluated in Section 11.

12.5 Report the direction of the test specimens if not in warp direction.

12.6 Under certain conditions, by agreement between principals to a transaction, tearing strength of the material can be used in lieu of, or to complement, the breaking or bursting strength. The material specification may further define the use of wet breaking, tearing, or bursting strength tests in lieu of or to complement those tests done under standard textile testing conditions. Such conditions of test shall be reported along with the data.

13. Precision and Bias

13.1 This test method may be used for acceptance testing of commercial shipments. However, caution is advised since information about *between-laboratory* precision shows a high variability between results. Interlaboratory testing using Option A (Daylight) showed a high

variability between results for samples exposed at different times of the year. Efforts to minimize the seasonal effect by time versus irradiance test duration did not compensate for this phenomenon for all fabrics. For some fabrics, exposure to a specific level of irradiance may result in a lower variation of results, while for other fabrics little difference may be seen between time and irradiance exposure. Further, the nature of the fabric, its finish or coating and the climate may affect the results. It is strongly recommended to begin exposures at the same time of the year for comparative purposes. This may minimize the seasonal effect.

13.1.1 In case of a dispute arising from differences in reported test results when using this test method for acceptance testing of commercial shipments, the purchaser and the supplier should conduct comparative tests to determine if there is a statistical bias between their laboratories. Statistical analysis is recommended for the investigation of bias. As a minimum, the two parties should take a group of test specimens that are as homogeneous as possible and that are from a lot of material of the type in question. Test specimens should then be randomly assigned in equal numbers to each laboratory for testing. The average results from the two laboratories should be compared using the appropriate Student's *t*-test and an acceptable probability level chosen by the two parties before testing is begun. If a bias is found either its cause must be found and corrected or the purchaser and the supplier must agree to interpret future test results for that material with consideration for the known bias.

13.1.2 *Interlaboratory Test Data, Breaking Strength Determinations.* An interlaboratory test was conducted in 1990 and 1991 in which randomly drawn samples of six materials were tested at three exposure sites in each, southern Florida and Arizona, in accordance with AATCC 111B. NOTE: Previous versions of TM 111 contain actual tabular data for the precision and bias.

Exposure Option (A or B) _____

Geographical Location _____

Exposure Date: From _____ to _____

Radiant Energy: _____

Exposure Latitude _____ Exposure Angle _____

Exposed behind window glass: Yes _____ No _____ If Yes, Type _____

Daily Ambient Temperature: Minimum _____ °C Maximum _____ °C Avg. _____ °C

Daily Black Panel Temperature: Minimum _____ °C Maximum _____ °C Avg. _____ °C

Daily Relative Humidity %: Minimum _____ Maximum _____ Avg. _____

Hours of Wetness: Rain _____ Rain and Dew _____

13.2 *Interlaboratory Test Data, Summary.* Interlaboratory testing using Option B (Daylight) showed a high variability between results for samples exposed at different times of the year. Efforts to minimize the seasonal effect by time versus irradiance test duration did not compensate for this phenomenon for all fabrics. For some fabrics, exposure to a specific level of irradiance may result in a lower variation of results, while for some fabrics little difference may be seen between time and irradiance exposure. Further, for some, the nature of the fabric, its finish or coating and the climate may effect the results. Differences between laboratories were small as shown by the zero, or near-zero components of variance reported in Tables II and III. The higher values for *between-laboratory* critical differences reported in Tables IV and V were driven by the high values for between seasonal quarter exposures. Consequently, it is strongly recommended to begin exposures for Options A and B at the same time of the year for comparative purposes. This may minimize the seasonal effect and components of variance would more likely be represented by the single operator precision.

13.4 *Precision.* For the components of variance reported in Tables II and III, two averages of observed values should be considered significantly different at the 95% probability level if the difference equals or exceeds the critical differences listed in Tables IV and V.

NOTE 1: The square roots of the components of variance are being reported to express the variability as a percent for Table II and as units of measure for Table III, rather than the square of those values. Critical differences were calculated using $z=1,960$.

NOTE 2: Since the interlaboratory test included only three laboratories for each geographical location, estimates of *between-laboratory* precision should be used with special caution. The tabulated values of the critical differences should be considered to be a general statement, particularly with respect to *between-laboratory* precision. Before a meaningful statement can be made about two specific laboratories, the amount of statistical bias, if any, between them must be established with each comparison being based on recent data obtained on specimens taken from a lot of material of the type being evaluated so as to be as nearly homogeneous as possible and then randomly assigned in equal numbers to each of the laboratories.

13.5. *Bias.* The values of weather resistance can only be defined in terms of a specific test method. Within this limitation, the procedure in Test Method 111 for measuring weather resistance of textiles using breaking strength criteria has no known

bias.

14. References

14.1 ASTM Standards (see 15.11)

14.1.1 D 5034 Test Method for Breaking Force and Elongation of Textile Fabrics (Grab Test).

14.1.2 D 5035 Test Method for Breaking Force and Elongation of Textile Fabrics (Strip Test).

14.1.3 D 2256 Test Method for Tensile Properties of Yarns by the Single-Strand Method.

14.1.4 D 3787 Test Method for Bursting Strength of Knitted Goods-Constant-Rate-of-Traverse (CRT) Ball Burst Test.

14.1.5 D 3786 Test Method for Hydraulic Bursting Strength of Textile Fabrics-Diaphragm Bursting Strength Tester Method.

14.1.6 D 1424 Test Method for Tearing Strength of Fabrics by Falling Pendulum (Elmendorf) Apparatus.

14.1.7 D 5587 Test Method for Tearing Strength of Fabrics by Trapezoid Procedure.

14.1.8 E 903 Test Method for Solar Absorbance, Reflectance, and Transmittance of Materials Using Integrating Spheres.

14.1.9 E 824 Standard Test Method for Transfer of Calibration from Reference to Field Pyranometers.

14.1.10 G 24 Standard Practice for Conducting Exposures to Daylight Filtered through Glass.

14.1.11 D 2905 Standard Practice for Statements on Number of Specimens for Textiles.

14.1.12 D 1776 Standard Practice for Conditioning and Testing Textiles.

14.2 AATCC Test Methods (see 15.12).

14.2.1 Method 16, Colorfastness to Light.

14.2.2 Evaluation Procedure 1, Gray Scale for Color Change.

14.2.3 Evaluation Procedure 7, Instrumental Assessment of the Change in Color of a Test Specimen.

15. Notes

15.1 A suitable test cabinet constructed to meet these specifications is available from William Harrison & Co., 4595 E. 10th Ct., Hialeah FL 33013; tel: 305/681-8381.

15.2 Window glass of the required quality is available from such dealers as: Libby Owens-Ford Glass Co., Toledo OH, 2 mm flat drawn sheet glass, single strength, quality B; or Pittsburgh Plate Glass Co., Pennvernon sheet glass, single strength, quality B, or equivalent.

15.3 Unless otherwise agreed upon, as when specified in an applicable material specification, take a number of specimens such that the user may expect at the 95% probability level that the test result is not more than 5.0% of the average above the true average of the lot. Determine the number of specimens using standard deviation with one-sided limits as directed in ASTM Practice D 2905.

15.4 Pile fabrics, such as carpets, which have fibers that may shift position, or texture which may make evaluations in small areas difficult should be tested with an exposed area of not less than approximately 40.0 mm (1.6 in.) by 50.0 mm (2.0 in.). Expose sufficient size or multiple specimens to include all colors in the sample.

15.5 In general, the warp direction is used, but the filling direction may be used in conjunction or in place of the warp direction when specified. Warp yarns sometimes are protected from the radiation due to fabric structure. When the filling direction is used, it must be reported.

15.6 Specimen frames must be made of stainless steel or suitably coated steel to avoid contaminating the specimens with metallic impurities that might catalyze or inhibit the degradation. When specimens are fastened with staples, they should be of the nonferrous type overcoated to avoid contamination of the specimen by corrosion products. Metal frames must have a dull finish and be designed to avoid reflectances that could influence the performance of the material. Frames shall conform to the curvature of the specimen rack. The size of the frame is determined by the type specimens required for individual property requirements.

15.7 The Eppley PS-P black and white pyranometer has been found suitable for measuring total sunlight radiant energy, and the Eppley Broad Band-Pass Ultraviolet Radiometer has been found suitable for measuring the radiant energy from 295-385 nm of sunlight. These instruments are available from Eppley Laboratory, 12 Sheffield Ave., Newport RI 02840; tel: 401/847-1020. The Radialux broad bandpass radiometer has been found suitable for measuring radiant energy from 300-400 nm of sunlight and is also available from SDL Atlas L.L.C., 1813A Associate Lane, Charlotte NC 28217; tel: 704/329-0911; fax: 704/329-0914; e-mail: info@sdlatlas.com; and Suga Test Instruments Co. Ltd., 5-4-14, Shinjuku, Shinjuku-ku, Tokyo, 160-0022, Japan; tel: +81 3 3354/5241; fax: +81 3 3354/5275.

15.8 Internationally recommended units for measuring and reporting radiant energy, factors to be used when converting from one unit to another and pyranometer/radiometer descriptions and classifications are taken from *Guide to Meteorological Instrument and Observing Practices*, World Meteorological Organization, WMO-No. 8 TP.3.

15.9 The Eppley Model 8-48 Black and White Pyranometer, a 2nd class pyranometer as classified by the World Meteorological Organization has been found suitable for measuring global (total sun and sky) radiation. The Eppley Ultraviolet Radiometer (Photometer) (not classified by the WMO at the time of printing) has been found suitable for measuring sun and sky ultraviolet radiation in the range of 295-285 nm. These instruments are available from the Eppley Laboratory, 12 Sheffield Ave., Newport RI 02840; tel: 401/847-1020.

15.10 A difference in color change properties between original material and the covered portion of the exposed specimen indicates that the textile has been affected by some agent other than light, such as heat or a reactive gas in the atmosphere. Although the exact cause difference in color may not be known, it should be noted in the report when it occurs.

Table II—Breaking Strength after Weathering ASTM Method D 5035, Strip Procedure

Fabric Exposure Location	Components of Variance, Coefficient of Variation, %								
	Grand Average Pounds		Single Operator Component		Within-Laboratory Component		Between-Laboratory Component		
	3 MO.	75 KJ	3 MO.	75 KJ	3 MO.	75 KJ	3 MO.	75 KJ	
MIL-C-44103									
ARIZONA	204	203	4.2	5.3	9.2	6.7	0	0	
SOUTHERN FLORIDA	201	201	4.0	3.7	3.2	4.7	0	0	
MIL-C-7219									
ARIZONA	150	162	4.2	5.4	46.6	31.6	0	0	
SOUTHERN FLORIDA	183	182	6.0	6.7	31.4	19.2	0	0	
MIL-C43285-B									
ARIZONA	236	244	10.3	6.5	26.6	19.8	0	0	
SOUTHERN FLORIDA	246	248	8.5	6.6	18.0	12.2	0	0	
MIL-C-4362-7A									
ARIZONA	64	69	4.1	3.9	13.8	14.4	4.8	0	
SOUTHERN FLORIDA	79	77	3.6	4.2	4.5	7.4	0.1	0	
ALLIED A-609-029-D									
ARIZONA	248	265	10.8	12.7	81.9	55.1	0	0	
SOUTHERN FLORIDA	286	284	9.9	17.0	46.2	33.6	0	0	
MIL-C-44103									
ARIZONA	210	211	4.6	3.9	7.2	6.8	0	0	
SOUTHERN FLORIDA	208	208	4.6	6.0	3.2	4.5	0	0	

NOTE: *Within-laboratory* component represents variation between quarterly exposure start times.

Table III—Instrumental Color Measurement, ΔE , After Weathering (AATCC Evaluation Procedure 6)

Fabric Exposure Location	Components of Variance, Standard Deviation, Units of Measure, Single Material Comparison							
	Grand Average Pounds		Single Operator Component		Within-Laboratory Component		Between-Laboratory Component	
	3 MO.	75 KJ	3 MO.	75 KJ	3 MO.	75 KJ	3 MO.	75 KJ
MIL-C-44103								
ARIZONA	2.00	1.88	0.19	0.14	0.61	0.49	0.15	0.10
SOUTHERN FLORIDA	2.14	2.07	0.09	0.19	0.47	0.43	0.11	0.23
MIL-C-7219								
ARIZONA	8.99	8.40	1.60	1.13	2.56	1.24	0	0.90
SOUTHERN FLORIDA	7.89	8.00	0.78	1.41	1.34	0	0	0
MIL-C43285-B								
ARIZONA	1.45	0.94	0.27	0.47	0.19	0.31	0.13	0
SOUTHERN FLORIDA	2.30	2.25	0.27	0.52	0.39	0	0.08	0
MIL-C-4362-7A								
ARIZONA	5.77	5.77	1.88	1.55	0.94	0.61	0	1.58
SOUTHERN FLORIDA	0.78	0.88	0.17	0.22	0	0	0	0
ALLIED A-609-029-D								
ARIZONA	14.2	13.2	0.78	0.90	5.23	2.28	0.42	0.92
SOUTHERN FLORIDA	11.9	11.8	0.72	0.98	1.94	1.37	0.51	0.80
MIL-C-44103								
ARIZONA	2.99	2.88	0.51	0.83	0.65	0	0	0
SOUTHERN FLORIDA	5.37	5.41	0.72	0.92	1.68	1.48	0	0

NOTE: *Within-laboratory* component represents variation between quarterly exposure start times.

Table IV—Breaking Strength After Weathering, ASTM Method D 5035, Strip Procedure

Fabric Exposure Location	Number of Observations in Each Average	Critical Difference for Conditions Noted, % of Average					
		Single-Operator Component		Within Quarterly Exposure Component		Between-Laboratory Component	
		3 MO.	75 KJ	3 MO.	75 KJ	3 MO.	75 KJ
MIL-C-44103							
ARIZONA	1	5.7	7.2	13.7	11.6	13.7	11.6
	2	4.1	5.1	13.1	10.4	13.1	10.4
	5	2.7	3.2	12.7	9.7	12.7	9.7
SOUTHERN FLORIDA	1	5.5	5.0	10.5	8.3	10.5	8.3
	2	3.9	3.6	9.8	7.5	9.8	7.5
	5	2.5	2.3	9.3	6.9	9.3	6.9
MIL-C-7219							
ARIZONA	1	7.9	9.2	86.5	54.9	86.5	54.9
	2	5.6	6.5	86.3	54.5	86.3	54.5
	5	3.5	4.1	86.2	54.3	86.2	54.3
SOUTHERN FLORIDA	1	9.0	10.2	48.5	31.0	48.5	31.0
	2	6.4	7.2	48.1	30.1	48.1	30.1
	5	4.0	4.6	47.8	29.6	47.8	29.6
MIL-C43285-B							
ARIZONA	1	12.1	7.4	33.5	23.7	33.5	23.7
	2	8.5	5.2	32.3	23.1	32.4	23.1
	5	5.4	3.3	31.7	22.8	31.7	22.8
SOUTHERN FLORIDA	1	9.6	7.4	22.4	15.5	22.4	15.5
	2	6.8	5.2	21.4	14.6	21.4	14.6
	5	4.3	3.3	20.7	14.1	20.7	14.1
MIL-C-4362-7A							
ARIZONA	1	17.9	15.8	62.7	59.9	66.2	59.9
	2	12.6	11.1	61.4	58.9	65.0	58.8
	5	8.0	7.0	60.7	58.2	64.2	58.2
SOUTHERN FLORIDA	1	12.7	15.2	20.4	30.8	20.4	30.8
	2	9.0	10.8	18.2	28.8	18.3	28.8
	5	5.7	6.8	16.9	27.6	16.9	27.6
ALLIED A-609-029-D							
ARIZONA	1	12.1	13.3	92.3	59.1	92.3	59.1
	2	8.5	9.4	91.9	58.4	91.9	58.4
	5	5.4	6.0	91.7	57.9	91.7	57.9
SOUTHERN FLORIDA	1	9.6	16.6	45.8	36.7	45.8	36.7
	2	6.8	11.7	45.3	34.8	45.3	34.8
	5	4.3	7.4	45.0	33.6	45.0	33.6
MIL-C-44103							
ARIZONA	1	6.0	5.1	11.3	10.3	11.3	10.3
	2	4.3	3.6	10.4	9.6	10.4	9.6
	5	2.7	2.3	9.9	9.2	9.9	9.2
SOUTHERN FLORIDA	1	6.1	8.0	7.4	10.9	7.4	10.0
	2	4.3	5.6	6.0	8.3	6.0	8.3
	5	2.7	3.6	5.0	7.0	5.0	7.0

Table V—Instrumental Color Measurement, ΔE , After Weathering (AATCC Evaluation Procedure 6)

Fabric Exposure Location	Number of Observations in Each Average	Critical Difference for Conditions Noted, Standard Deviation, Units of Measure					
		Single-Operator Component		Within Quarterly Exposure Component		Between-Laboratory Component	
		3 MO.	75 KJ	3 MO.	75 KJ	3 MO.	75 KJ
MIL-C-44103 ARIZONA	1	0.52	0.40	1.76	1.42	1.81	1.44
	2	0.37	0.28	1.72	1.39	1.77	1.41
	5	0.23	0.18	1.70	1.37	1.75	1.40
SOUTHERN FLORIDA	1	0.25	0.53	1.33	1.30	1.36	1.45
	2	0.18	0.37	1.32	1.25	1.35	1.40
	5	0.13	0.24	1.31	1.21	1.34	1.37
MIL-C-7219 ARIZONA	1	4.43	3.14	8.37	4.66	8.37	5.28
	2	3.13	2.22	7.76	4.10	7.76	4.79
	5	1.98	1.40	7.37	3.72	7.37	4.47
SOUTHERN FLORIDA	1	2.17	3.90	4.29	3.90	4.29	3.90
	2	1.53	2.75	4.01	2.75	4.01	2.75
	5	0.97	1.74	3.83	1.74	3.83	1.74
MIL-C43285-B ARIZONA	1	0.76	1.32	0.92	1.58	0.99	1.58
	2	0.54	0.93	0.75	1.27	0.83	1.27
	5	0.34	0.59	0.63	1.05	0.72	1.05
SOUTHERN FLORIDA	1	0.74	1.44	1.30	1.44	1.32	1.44
	2	0.52	1.02	1.19	1.02	1.21	1.02
	5	0.33	0.64	1.12	0.64	1.14	0.64
MIL-C-4362-7A ARIZONA	1	5.20	4.28	5.82	4.60	5.82	6.36
	2	3.68	3.02	4.51	3.46	4.51	5.59
	5	2.32	1.92	3.50	2.55	3.50	5.08
SOUTHERN FLORIDA	1	0.47	0.60	0.47	0.60	0.47	0.60
	2	0.34	0.42	0.34	0.42	0.34	0.42
	5	0.21	0.27	0.21	0.27	0.21	0.27
ALLIED A-609-029-D ARIZONA	1	2.16	2.49	14.7	6.79	14.7	7.25
	2	1.52	1.76	14.6	6.56	14.6	7.03
	5	0.96	1.12	14.5	6.41	14.6	6.90
SOUTHERN FLORIDA	1	1.98	2.72	5.72	4.67	5.89	5.17
	2	1.40	1.93	5.55	4.26	5.72	4.79
	5	0.89	1.22	5.44	3.99	5.62	4.56
MIL-C-44103 ARIZONA	1	1.41	2.30	2.29	2.30	2.29	2.30
	2	1.00	1.63	2.06	1.63	2.06	1.63
	5	0.71	1.03	1.93	1.03	1.93	1.03
SOUTHERN FLORIDA	1	2.00	2.56	5.06	4.83	5.06	4.83
	2	1.41	1.81	4.86	4.48	4.86	4.48
	5	0.89	1.14	4.74	4.26	4.74	4.26

15.11 Available from ASTM, 100 Barr Harbor Dr., W. Conshohocken PA 19428-2959; tel: 610/832-9500; fax: 610/832-9555.

15.12 Available from AATCC, PO Box 12215, Research Triangle Park NC 27709; tel: 919/549-8141; fax: 919/549-8933; e-mail: orders@aatcc.org.

Appendix A

Apparatus and Material-Daylight Exposure

A1. General Conditions, Daylight Exposure, Options A and B

A1.1 The cabinet or rack shall be located where it will receive direct sunlight throughout the day and where shadows of objects in the vicinity will not fall upon it. When the cabinet or rack is installed over soil, the distance between the bottom of the cabinet or rack and the plane of the cleared area shall be great enough to prevent damage which could possibly occur during maintenance (grass cutting, re-graveling, weed control, etc.).

A1.2 Exposure cabinets or racks shall be located in clear areas, preferably at a suitable number of climatologically different sites representing the various conditions under which the material will be used. Major climatological variations include sub-tropical, desert, seashore (salt air), industrial atmosphere and areas exhibiting a wide range in percentage of available sunshine. The area beneath and in the vicinity of the cabinets or racks should be characterized by low reflectance and be typical of the ground cover in that climatological area. In desert areas, it should be gravel whereas in most temperate and sub-tropical areas, it should be low cut grass.

A1.3 Instruments for determining climatological data during the exposure period shall be operated in the immediate area of the exposure cabinets or racks. To characterize the conditions around the test frame, these instruments should be capable of recording: ambient temperature (daily minimum and maximum), Black Panel temperature, relative humidity (daily minimum and maximum), hours of precipitation (rain), and total hours of wetness (rain and dew).

A1.4 Other methods of radiation measurement may be used when mutually agreed between principals to a transaction. Total ultraviolet radiation reported in kJ/m² has been used in the past, however, the relative degradative effect of a given amount of radiant energy obtained

at different locales in different seasons may be found to be different due to temperature effects and to variations in ratios of UV, visible and infrared components.

A2. Option A-Daylight Exposure with Wetting

A2.1 Exposure racks. A suitable exposure rack consists of a structure elevated above ground facing due south in the Northern Hemisphere and due north in the Southern Hemisphere. The angle of the rack from the horizontal must be at the same angle as the location at which the tests are made or any angle, such as 45°, when agreed upon. When the specimens are mounted on the rack without backing there must be free air access to the back of the specimens at all times.

A2.2 Under certain conditions, to simulate certain conditions of end-use when specified, expose specimens with a backing. Report that a backing was used, the type and its specific nature. Exposures are continuous 24 h a day until the required exposure has been attained.

A3. Option B-Behind Glass Daylight Exposure Cabinet and Location, Without Wetting

A3.1 The daylight exposure cabinet shall consist of a glass-covered enclosure of any convenient size constructed of metal, wood or other satisfactory material to protect the specimens from rain and weather, and be well ventilated to allow free flow of air over the specimens. The glass cover shall be a sheet 2.0-2.5 mm thick piece of good grade, clear and flat-drawn. In order to reduce variability due to changes in UV transmission of glass, all new glass shall be exposed facing the equator, at the site latitude angle, according to ASTM G7, or an empty under glass exposure cabinet, for at least three months prior to installation in test cabinets. It shall be single strength, free of bubbles or other imperfections. Typically, "single strength" glass will have a transmittance of 10-20% at 320 nm and at least 85% at wavelengths of 380 nm or higher after the three month pre-aging procedure. If transmittance of the glass is measured, report the average for at least three pieces of the lot of glass being tested. Follow the instructions for measurement of transmittance of solid samples recommended by the manufacturer of the UV-visible spectrophotometer

used. If a spectrophotometer with an integrating sphere is used, the measurements shall be performed in accordance with ASTM E 903. (see 15.1 and 15.2).

A3.2 The enclosure or cabinet shall be equipped with a rack which supports the specimens in a plane parallel to that of the glass cover with the face of the specimen at a distance below it of not less than 75.0 mm (3.0 in.). The specimen mounting rack shall be constructed of a material that is compatible with the test specimens. It may be either the open type providing good ventilation on the back side of the specimen, or of a solid material as required. To minimize shadows from the top and the sides of the cabinet, the usable exposure area under glass shall be limited to that of the glass cover reduced by twice the distance from the cover to the specimens.

A3.3 The glass cover and the test specimen shall slope toward the equator at an angle from the horizontal equal in degrees to approximately the latitude of the location at which the tests are being made. Other angles of exposure, such as 45°, may be used, but the angle must be reported in the results of test.

A3.4 If required to characterize the conditions within the test frame, instruments should be capable of recording: ambient temperature under glass (daily minimum and maximum), Black Panel Temperature under glass, total radiant energy and ultraviolet radiant exposure (either broad or narrow bandpass) at the same angle of exposure as the test specimens, and relative humidity (daily minimum and maximum).

A3.5 If required, an ultraviolet radiometer shall be used to measure irradiance, and connected to an integrator for computing ultraviolet radiant exposure. The ultraviolet radiometer shall be mounted behind glass of the same type used in the exposure cabinet, or equivalent, in a ventilated enclosure to avoid overheating the instrument. The enclosure containing the radiometer shall maintain the same orientation as the test cabinet. Two different types of radiometers may be used:

A3.5.1 A wide-band ultraviolet radiometer (see 15.7 and 15.10), an instrument which measures irradiance at wavelengths 295-385 nm.

A3.5.2 A narrow-band ultraviolet radiometer (see 15.7 and 15.10), instrument which measures irradiance centered at a wavelength of 340 ± 2 nm.

Formaldehyde Release from Fabric, Determination of: Sealed Jar Method

Developed in 1965 by AATCC Committee RR68; reaffirmed 1968, 1972, 1989, 1998, 2003; revised 1975, 1978, 1982, 1984, 1993; technical correction 1983; editorially revised 1985, 1986; editorially revised and reaffirmed (with new title) 1990.

1. Purpose and Scope

1.1 This test method is applicable to textile fabrics that may evolve formaldehyde, particularly fabrics finished with chemicals containing formaldehyde. It provides accelerated storage conditions and an analytical means for determining the amount of formaldehyde released under the conditions of accelerated storage (see Section 5 and 10.1).

1.2 An optional accelerated incubation procedure is available (see 13.5).

2. Principle

2.1 A weighed fabric specimen is suspended over water in a sealed jar. The jar is placed in an oven at a controlled temperature for a specified length of time (see 13.5). The amount of formaldehyde absorbed by the water is then determined colorimetrically.

3. Terminology

3.1 **formaldehyde release**, n.—that formaldehyde evolved from textiles under the accelerated storage conditions of this test, including that which is free (unbound or occluded) from unreacted chemicals, or from finish degradation as a result of this test.

4. Safety Precautions

NOTE: These safety precautions are for information purposes only. The precautions are ancillary to the testing procedures and are not intended to be all inclusive. It is the user's responsibility to use safe and proper techniques in handling materials in this test method. Manufacturers MUST be consulted for specific details such as material safety data sheets and other manufacturer's recommendations. All OSHA standards and rules must also be consulted and followed.

4.1 Good laboratory practice should be followed. Wear safety glasses in all laboratory areas.

4.2 When handling glacial acetic acid to prepare Nash reagent, use chemical goggles or face shield, impervious gloves

and an impervious apron during preparation. Concentrated acids should be handled only in an adequately ventilated laboratory hood. CAUTION: Always add acid to water.

4.3 Formaldehyde is a sensory irritant and potential sensitizer. Its chronic toxicity has not been fully established. Use in an adequately ventilated laboratory hood. Avoid inhalation or skin contact. Use chemical goggles or face shield, impervious gloves and an impervious apron when working with formaldehyde.

4.4 An eyewash/safety shower should be located nearby and a self-contained breathing apparatus should be readily available for emergency use.

4.5 Exposure to chemicals used in this procedure must be controlled at or below levels set by governmental authorities (e.g., Occupational Safety and Health Administration's [OSHA] permissible exposure limits [PEL] as found in 29 CFR 1910.1000 of January 1, 1989). In addition, the American Conference of Governmental Industrial Hygienists (ACGIH) Threshold Limit Values (TLVs) comprised of time weighted averages (TLV-TWA), short term exposure limits (TLV-STEL) and ceiling limits (TLV-C) are recommended as a general guide for

air contaminant exposure which should be met (see 13.7).

5. Uses and Limitations

5.1 The procedure is intended for use in the range of releasable formaldehyde on the fabric up to about 3500 $\mu\text{g/g}$. The upper limit is 500 $\mu\text{g/g}$ if a 1:1 ratio of Nash reagent to sample solution is used in the analytical portion of the test and 3500 $\mu\text{g/g}$ if a 10:1 ratio is used. The procedure promotes formaldehyde release from odor-free, fully cured durable press fabrics that have been afterwashed (Vail, S. L. and B. A. K. Andrews, *Textile Chemist and Colorist*, Vol. 11, No. 1, January 1979, p. 48). For these reasons, the procedure should not be used to estimate $\mu\text{g/g}$ formaldehyde in air for compliance with any mandated or voluntary standards. The procedure was originally developed to measure the "propensity of a resin-treated fabric to liberate an excessive amount of formaldehyde under hot, humid conditions." (Nuessle, A. C., *American Dyestuff Reporter*, Vol. 55, No. 17, 1966, pp. 48-50; also Reid, J. D., R. L. Arceneaux, R. M. Reinhardt and J. A. Harris, *American Dyestuff Reporter*, Vol. 49, No. 14, 1960, pp. 29-34.)

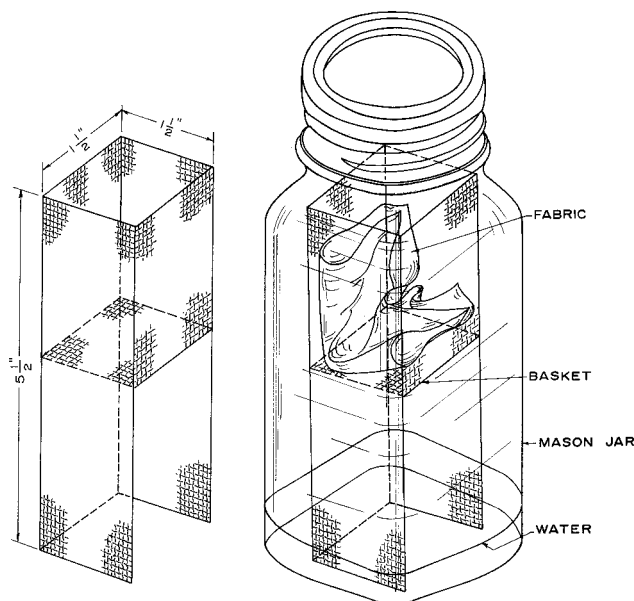

Fig. 1—The wire mesh basket detailed on the left is suspended in a sealed jar with one fabric specimen as shown on the right.

6. Apparatus and Materials

6.1 Mason or equivalent canning jars, 0.95 L (1 qt) and gas sealing caps.

6.2 Small wire mesh baskets (or other suitable means for suspending fabric above the water level inside the jars; see 13.1). As an alternative to the wire mesh baskets, a double strand of sewing thread may be used to make a loop in the fabric that has been folded in half twice, suspended above the water level. The two double-thread ends are draped over the top of the jar and held securely by the jar cap.

6.3 Thermostatically controlled oven, $49 \pm 1^\circ\text{C}$ ($120 \pm 2^\circ\text{F}$) (see 13.5).

6.4 Nash reagent prepared from ammonium acetate, acetic acid and acetylacetone and water (see 7.1).

6.5 Formaldehyde solution, approximately 37%.

6.6 Volumetric flasks, 50, 500 and 1000 mL.

6.7 Mohr pipettes, graduated in tenths of a mL; and 5, 10, 15, 20, 25, 30 and 50 mL volumetric pipettes, all calibrated "to deliver" and meeting Class B volume accuracy and flow time requirements (see 13.2).

6.8 Graduated cylinders, 10 and 50 mL, graduated in mL, calibrated "to deliver" and meeting Class A volume accuracy requirements (see 13.2).

6.9 Photoelectric colorimeter or spectrophotometer (see 10.2).

6.10 Test tubes or colorimeter tubes (see 13.2).

7. Preparation of Nash Reagent

7.1 In a 1000 mL volumetric flask, dissolve 150 g of ammonium acetate in about 800 mL of distilled water; add 3 mL of glacial acetic acid and 2 mL of acetylacetone. Make up to the mark with distilled water and mix. Store in a brown bottle.

7.2 The reagent darkens in color slightly on standing over the first 12 h. For this reason the reagent should be held 12 h before use. Otherwise, the reagent is usable over a considerable period of time, at least 6-8 weeks. However, since the sensitivity may change slightly over a long period of time, it is good practice to run a calibration curve weekly to correct for slight changes in the standard curve.

8. Preparation of Standard Solution and Calibration (Caution)

8.1 Prepare an approximately 1500 $\mu\text{g}/\text{mL}$ stock solution of formaldehyde by diluting 3.8 mL of reagent grade formaldehyde solution (approximately 37%) to one liter with distilled water. Equilibrate the stock solution for at least 24 h before standardization. Determine the concentration of formaldehyde in the stock solu-

tion by a standard method (see 13.6 or any other suitable procedure such as sodium sulfite titration using 0.1 N HCl. Reference: J. Frederick Walker, *Formaldehyde*, 3rd Ed. Reinhold Publ. Co., New York, 1964, p. 486). Record the actual concentration of this standardized stock solution. This stock solution will keep for at least four weeks and is used to prepare standard dilutions. A 1:10 dilution of the standardized formaldehyde stock solution is prepared by pipetting 25 mL of the standardized stock solution into a 250 mL volumetric flask and diluting to the mark with distilled water. If the stock solution is titrated and found to be different than 1500 $\mu\text{g}/\text{mL}$, three methods that can be used for preparing the calibration curves are:

8.1.1 Calculate new volumes of stock solution aliquots to pipette to achieve exactly 1.5, 3.0, 4.5, 6.0 and 9.0 $\mu\text{g}/\text{mL}$, respectively. (For example, if the formaldehyde stock solution were found to be 1470 $\mu\text{g}/\text{mL}$ by titration, not 1500 $\mu\text{g}/\text{mL}$, pipette 5.1 mL, 10.2 mL, 15.3 mL, 20.4 mL and 30.6 mL of the 147 $\mu\text{g}/\text{mL}$ dilution into a 500 mL volumetric flask and dilute to mark with distilled water.) (NOTE: It is easy to make errors using a graduated pipette!)

8.1.2 Pipette 5, 10, 15, 20 and 30 mL of the 1:10 dilution into a 500 mL volumetric flask and dilute to mark with distilled water. (If, for example, the standardized stock solution were found to be 1470 $\mu\text{g}/\text{mL}$ by titration, calculate new values for the calibration curve abscissa; i.e., 1.47, 2.94, 4.41, 5.88, 8.82 $\mu\text{g}/\text{mL}$.) This is the preferred method for those with a microprocessor spectrophotometer or computer. However, it is harder to plot manually.

8.1.3 Calculate a concentration correction factor for each sample. Correct the concentration for the dilution value using this factor. Plot the curve as if each of the dilutions were exactly 1.5, 3.0, 4.5, 6.0 and 9.0 $\mu\text{g}/\text{mL}$. Calculate the correct concentration for each of these values using the factor. For example, if the standardized stock solution were found to be 1470 $\mu\text{g}/\text{mL}$ by titration, then the correction factor (*CF*) is:

$$CF = \frac{\text{Actual}}{\text{Nominal}} = \frac{1470}{1500} = 0.980$$

8.2 When 5, 10, 15, 20 and 30 mL aliquots of the 1:10 dilution of the standardized stock solution from 8.1 are diluted with distilled water in 500 mL volumetric flasks, formaldehyde solutions containing approximately 1.5, 3.0, 4.5, 6.0 and 9.0 $\mu\text{g}/\text{mL}$ formaldehyde respectively will be obtained. Record accurately the concentration of solutions. The equivalent concentrations of the formaldehyde in the test fabric based on the weight of

1 g of the test fabric and 50 mL of water in the test jars, will be 50 times the accurate concentrations of these standard solutions.

8.3 Use 5 mL aliquots of each of the standard solutions and the procedure described in 10.4-10.7 to prepare a calibration chart in which $\mu\text{g}/\text{mL}$ formaldehyde are plotted against absorbance.

9. Test Specimens

9.1 Cut approximately 1 g specimens; weigh each one to ± 0.01 g.

10. Procedures

10.1 Place 50 mL of distilled water in the bottom of each jar. Suspend one fabric specimen above the water in each jar, using a wire mesh basket or other means (see Fig. 1). Seal the jars and place them in the oven at $49 \pm 1^\circ\text{C}$ ($120 \pm 2^\circ\text{F}$) for 20 h (see 13.5).

10.2 Remove and cool the jars for at least 30 min.

10.3 Remove the fabric and baskets, or other support, from the jars. Recap the jars and shake them to mix any condensation formed on the jar sides.

10.4 Pipette 5 mL of Nash reagent into a suitable number of test tubes, small (50 mL) Erlenmeyer flasks, or other suitable flasks (colorimeter or spectrophotometer tubes can be used directly, see 13.2) and pipette 5 mL of the reagent into at least one additional tube for a reagent blank. Add 5 mL aliquots from each of the sample incubation jars to the tubes and 5 mL of distilled water to the tube which is used as a reagent blank.

10.5 Mix and place the tubes in a $58 \pm 1^\circ\text{C}$ water bath for 6 min. Remove and cool.

10.6 Read the absorbance in the colorimeter or spectrophotometer against the reagent blank using a blue filter or a wavelength of 412 nm. **Caution:** Exposure of the developed yellow color to direct sunlight for a period of time will cause some fading. If there is appreciable delay in reading the tubes after color development and strong sunlight is present, care should be exercised to protect the tubes such as by covering them with a cardboard box or by similar means. Otherwise the color is stable for considerable time (at least overnight) and reading may be delayed.

10.7 Determine the $\mu\text{g}/\text{mL}$ formaldehyde (HCHO) in the sample solutions using the prepared calibration curve (see 8.3 and 13.3).

11. Calculation

11.1 Calculate the amount of formaldehyde released for each specimen to the nearest $\mu\text{g}/\text{g}$ using the following equation:

$$F = (C) (50)/W$$

where:

F = concentration of formaldehyde ($\mu\text{g/g}$),

C = concentration of formaldehyde in solution as read from the calibration curve, and

W = weight of the test specimen, g.

12. Precision and Bias

12.1 Precision.

12.1.1 *Interlaboratory tests.* Two interlaboratory studies (ILS) of AATCC Method 112 were conducted in 1990 and 1991, with a 20 h incubation at 49°C and a 5/5 sample to Nash solution ratio. Single operators in each participating laboratory ran triplicate determinations on each fabric. In the first ILS, results from nine laboratories testing one fabric each at three low formaldehyde levels in the range of 100-400 $\mu\text{g/g}$ were analyzed by analysis of variance (ANOVA). In the second ILS, results from eight laboratories testing ten fabrics of nominal 0 $\mu\text{g/g}$ were analyzed by ANOVA. The analyses have been deposited for reference in the RA68 committee files.

12.1.2 Critical differences were calculated for zero-formaldehyde fabrics, shown in Table I, and for low level-formaldehyde fabrics shown in Table II.

12.1.3 When two or more laboratories wish to compare test results, it is recommended that laboratory level be established between them prior to beginning test comparisons.

12.1.4 If comparisons are made between laboratories on a single fabric level of formaldehyde release, the critical differences in the column, single level, in Table II should be used.

12.1.5 If comparisons are made be-

tween laboratories on a series of fabrics of a range of formaldehyde levels, the critical differences in the column, multiple levels, in Table II should be used.

12.1.6 The number of determinations per laboratory average (det/avg) also determines the critical difference.

12.2 Bias.

12.2.1 The formaldehyde release of a fabric can be defined only in terms of a test method. There is no independent method for determining the true value. As a means of estimating formaldehyde released from a fabric under the conditions of accelerated storage in AATCC Method 112, the method has no known bias.

12.2.2 AATCC Method 112 generally is accepted by the textile and apparel industries as a referee method.

13. Notes

13.1 A simple cloth support for insertion in the mason jars can be constructed as follows: A piece of aluminum wire screening 15.2 \times 14.0 cm (6.0 \times 5.5 in.) is bent around a length of wood 3.8 cm (1.5 in.) square and fastened together to form a rectangular, open-ended cage. One side is cut at the corners about half-way up the side and the cut section folded inward and fastened. This folded piece forms the bottom of the wire basket while the other three sides form the support legs. Fastening can be accomplished by twisting short lengths of wire through or around the appropriate part.

13.2 The ratio of reagent to sample solutions can be adjusted, within limits, to suit the individual absorbance range and optical path length of the sampling tubes or cuvettes of the particular photometric instrument being used. For example, although 5 mL reagent to 5 mL sample solution has been found convenient for several types of instruments, other 1:1 ratios, such as a ratio of 2 mL reagent to 2 mL sample may be more suitable for others. The same ratio should be used with the standards as with the sample. The use of colorimeter or spectrophotometer tubes directly for color developments avoids the transfer step, test tubes to spectrophotometer cells, and may save considerable time when many determinations are to be made. Repipettes or similar devices can be used for reagent dispensing, and Oxford or Eppendorf disposable tip automatic pipettes can be used for the sample solutions.

13.3 The procedure in Section 10 has been set up to cover the range from about 0 $\mu\text{g/g}$ on the weight of the fabric to about 500 $\mu\text{g/g}$. In fabrics containing releasable formaldehyde in the range from 500 $\mu\text{g/g}$ on the weight of the fabric to about 3500 $\mu\text{g/g}$, it is recommended that a ratio of 10 mL Nash reagent to 1 mL sample be used. If this is done, it is necessary to prepare an additional calibration chart with 10:1 ratios of standard solutions to Nash reagent by diluting 5, 10, 15 and 20 $\mu\text{g/mL}$, respectively, of the approximately 1500 $\mu\text{g/mL}$ standardized stock solution of formaldehyde to the mark with distilled water in 500 mL volumetric flasks. Formaldehyde solutions containing approximately 15, 30, 45 and 60 $\mu\text{g/mL}$ respectively will be obtained (see 8.3).

13.4 The chromotropic acid colorimetric method can be used as an alternate to the Nash reagent for the determination of the formaldehyde content of the sample jars after oven in-

cubation. It should be noted that the Precision and Bias Statement was not developed using the chromotropic acid method. A suitable procedure is given in J. Frederick Walker, Formaldehyde, 3rd Edition, Reinhold Publishing Co., NY, 1964, p470. When using this method a change may be necessary in the size of both the aliquots taken from the sample jars (see 10.2) and the standard formaldehyde solutions used in preparing the calibration curve (see 8.3). **Caution!** Since concentrated sulfuric acid is used with the chromotropic acid method, adequate care should be exercised to protect operating personnel and spectrophotometric equipment.

13.5 Incubation conditions of 65 \pm 1°C (149 \pm 4°F) for 4 h can be used as an alternate to the incubation conditions of 49 \pm 1°C (120 \pm 2°F) for 20 h (see 5.3 and 10.1). The incubation conditions of time and temperature must be reported. Upon completion of the 4-h incubation period, remove and cool the jars for at least 30 min and remove the fabric from the jars. Recap the jars and shake them to mix any condensation formed on the jar sides. Procedures for sample preparation and color development following the incubation period are performed as outlined in 10.4-10.7.

13.6 Standardization of Formaldehyde Stock Solution. General: The stock solution containing approximately 1500 $\mu\text{g/mL}$ of formaldehyde must be accurately standardized in order to make precise calculations from the calibration curve used in colorimetric analysis.

An aliquot of the stock solution is reacted with an excess of sodium sulfite followed by a back-titration with standard acid solution in the presence of thymolphthalein as indicator.

Apparatus: 10-mL volumetric pipette, 50-mL volumetric pipette, 50-mL burette, 150-mL Erlenmeyer flask.

Reagents: 1 M sodium sulfite (126 g Anhydrous $\text{Na}_2\text{SO}_3/\text{L}$), 0.1% Thymolphthalein Indicator in ethanol, 0.02 N sulfuric acid (can be purchased in standardized form from chemical supply companies or must be standardized from standard NaOH solution). Do not use commercial standardized sulfuric acid that has been stabilized with formaldehyde. If there is a doubt, check with the chemical supplier.

Procedure: A. Pipette 50 mL of 1 M Na_2SO_3 into the Erlenmeyer flask. B. Add 2 drops of thymolphthalein indicator. C. Add a few drops of standard acid until blue color disappears (if necessary). D. Pipette 10 mL of the stock formaldehyde solution to the flask. (Blue color will reappear.) E. Titrate the solution with the standard 0.02 N H_2SO_4 until the blue color is discharged. Record the volume of acid used. (The volume of acid should be in the range of 25 mL for 0.02 N acid.)

Calculations:

$$C = (30,030) (A) (N)/10$$

where:

C = Wt/Vol concentration of formaldehyde ($\mu\text{g/mL}$)

A = Vol of acid used (mL)

N = Normality of acid

Perform the standardization in duplicates. Average the results and use the accurate concentration in preparing the calibration curve for the colorimetric analysis.

13.7 Available from Publications Office, ACGIH, Kemper Woods Center, 1330 Kemper Meadow Dr., Cincinnati OH 45240; tel: 513/742-2020.

Table I—Critical Differences for Zero Formaldehyde

Det/Avg	Critical Differences for Averages 95% Probability, $\mu\text{g/g}$		
	Within Lab	Single Fabric Between Labs	Multiple Fabric Between Labs
1	7.7	12.0	13.8
2	5.5	10.6	12.7
3	4.5	10.2	12.3

Table II—Critical Differences for Low Level Formaldehyde

Det/Avg	Critical Differences for Averages 95% Probability, $\mu\text{g/g}$		
	Within Lab	Single Fabric Between Labs	Multiple Fabric Between Labs
1	21.6	80.3	116.0
2	15.2	78.9	115.0
3	12.4	78.4	114.7

Chlorine, Retained, Tensile Loss: Multiple Sample Method

Developed in 1965 by AATCC Committee RR35; reaffirmed 1967, 1971, 1974, 1977, 1980, 1989, 1999; editorially revised and reaffirmed 1985, 1994, 2005; editorially revised 1992, 2004.

1. Purpose and Scope

1.1 This test method is a simplified procedure for testing multiple samples to determine the potential damage that may be caused by chlorine bleaching.

2. Principle

2.1 The samples are chlorine bleached in a domestic-type laundry machine, rinsed, dried and pressed between hot metal plates. The damaging action of the retained chlorine is calculated from the difference in tensile strength before and after pressing (see 10. 1).

3. Terminology

3.1 **retained chlorine**, *n.*—*in textiles bleached with chlorine-type bleaches*, available chlorine which remains in the material after washing and drying.

4. Safety Precautions

NOTE: These safety precautions are for information purposes only. The precautions are ancillary to the testing procedures and are not intended to be all inclusive. It is the user's responsibility to use safe and proper techniques in handling materials in this test method. Manufacturers MUST be consulted for specific details such as material safety data sheets and other manufacturer's recommendations. All OSHA standards and rules must also be consulted and followed.

4.1 Good laboratory practices should be followed. Wear safety glasses in all laboratory areas.

4.2 Manufacturer's safety recommendations should be followed when operating laboratory testing equipment.

4.3 Use chemical goggles, rubber gloves and apron to protect skin and eyes during handling of sodium hypochlorite and sodium carbonate solutions.

4.4 An eyewash/safety shower should be located nearby for emergency use.

5. Apparatus and Reagents

5.1 Automatic agitator-type washing

machine having:

(a) Controlled wash-water and rinse-water temperature settings of $41 \pm 3^\circ\text{C}$ ($105 \pm 5^\circ\text{F}$).

(b) Normal agitator speed no slower than 47 cycles/min.

(c) Final spin speed (range 480-660 rpm).

(d) Final spin cycle time of 4-6 min.

5.2 Automatic tumble dryer having:

(a) Controlled exhaust temperature which cycles to 71°C (160°F) but does not exceed it.

(b) A cooling period while tumbling 5-10 min at the end of the drying cycle.

5.3 pH meter (see 10.2).

5.4 Scorch Tester (see 10.3).

5.5 Tensile Strength Tester (see 10.4).

5.6 Sodium hypochlorite solution, approx. 5% available chlorine (see 10.5).

5.7 Buffer solution (see 10.6).

5.8 Sodium tetraphosphate ($\text{Na}_6\text{P}_4\text{O}_{13}$).

5.9 Sodium carbonate.

5.10 Sodium bicarbonate.

5.11 Cotton cloth, kier-bleached, for ballast (see 7.2).

6. Preparation of Samples

6.1 Normally, only the warp strength is determined. Cut the sample approximately 35.6 cm (14 in.) in the warpwise direction and 20.3 cm (8 in.) in the fillingwise direction. (If testing filling specimens, reverse these figures.)

7. Procedure

7.1 Preparation of Washing Machine. If the washing machine has been used for anything other than chlorine bleaching, operate it through a full wash cycle with water, adding 0.15% sodium tetraphosphate at the beginning of the cycle. After machine is free of impurities, set the machine for the following conditions:

(a) Regular cycle.

(b) Low water level (see 10.7).

(c) Wash and rinse water at $41 \pm 3^\circ\text{C}$ ($105 \pm 5^\circ\text{F}$).

7.2 Chlorination. Permit wash water to enter machine to specified level. Add sufficient diluted sodium hypochlorite to wash water to obtain a bath liquor concentration of 0.10% by weight of available chlorine. Adjust the pH to 9.5 with sodium carbonate to raise the pH or sodium bicarbonate to lower it. Add all the test samples and sufficient untreated kier-boiled bleached cotton to make a 50:1 liquor-to-cloth ratio. Run machine through wash portion of cycle.

7.3 Rinsing. After the first load of wash water has been dumped and the machine has been refilled, add 10 mL of the buffer solution (see 10.6) for each gallon of water and continue operation through the remaining rinse cycles and the final spin cycle. If there is more than one deep rinse, the buffer is added only to the first one.

7.4 Drying and Conditioning. Place samples in a tumble dryer until just dry (do not press!). Transfer at once to a conditioned atmosphere at $65 \pm 2\%$ RH and $21 \pm 1^\circ\text{C}$ ($70 \pm 2^\circ\text{F}$) and allow to remain through the scorching step and tensile strength testing. The samples should be conditioned not less than 4 nor more than 24 h before scorching, and not less than 16 h before tensile testing.

7.5 Preparation of Specimens for Scorching. Prepare warp specimens by carefully cutting five strips approx. 35.6×3.2 cm (14.0×1.25 in.). Ravel the 3.2 cm (1.25 in.) strips to exactly 2.54 cm (1 in.) following ASTM Test Method D 5035, Breaking Force and Elongation of Textile Fabrics (Strip Test) (see 10.8). Then trim the 35.6 cm (14 in.) length of each strip to 30.5 cm (12 in.) From this set of five 2.54×30.5 cm (1×12 in.) strips, make two sets (from the same set of warp threads) of 2.54×15.2 cm (1×6 in.) raveled strip specimens by cutting the strips in two. Keep these sets separate; one set to be scorched, the other to be used as a control.

7.6 Preparation of Scorch Tester. Prepare Scorch Tester in advance so that the heating plates of the instrument maintain a temperature of $185 \pm 1^\circ\text{C}$ ($365 \pm 2^\circ\text{F}$). If necessary, to avoid air currents, enclose instrument in a cabinet. Make sure the two heating plates are clean and in good adjustment (uniformly in contact at all points) (see 10.9). Scorch each strip of one set separately (one at a time) by placing the 2.54×15.2 cm (1×6 in.) specimens in the Scorch Tester with the long direction of the raveled strip perpendicular to the long direction of the heating plates so that it is scorched across the center of the raveled strip. Scorch the strips for 30 s. Check reading of the thermometers frequently during use. Condition the specimens again, this time conditioning at least 16 h before making tensile strength measurements.

7.7 Tensile Strength. Make tensile strength tests on the unscorched and scorched specimens and record the individual values. From these, calculate the average tensile strength for each set.

8. Calculation of Results and Report

8.1 Use the formula:

$$(T_c - T_{cs})/T_c \times 100$$

= % loss in tensile strength due to damage caused by retained chlorine

where:

T_c = average tensile strength of chlorinated specimens, unscorched, and

T_{cs} = average tensile strength of chlorinated specimens, scorched.

8.2 Report percent loss in tensile strength for *warp* due to damage caused by retained chlorine.

8.2.1 If filling strength loss is determined report percent loss in tensile strength for *filling*.

9. Precision and Bias

9.1 *Precision*. The standard deviation obtained in developing this method was $\sigma = 5.98$.

The confidence interval based on 5 specimens is C.I. ± 5.2 . This confidence interval is around the percent loss in tensile strength.

9.2 *Bias*. The retained chlorine by tensile loss, multiple sample method, can be defined only in terms of a test method. There is no independent method for determining the true value. As a means of estimating this property, the method has no known bias.

10. Notes

10.1 Where it is suspected that either fabric or finish is susceptible to damage on heating, this susceptibility can be determined by running a distilled-water control, that is, the fabric is run through the entire procedure, but using distilled water in place of the hypochlorite solution. The loss in strength due to heat alone is calculated by the equation:

$$(T_w - T_{ws})/T_w \times 100$$

= Percent tensile strength loss due to scorching alone

where:

T_w = average tensile strength of the water-treated specimens, unscorched, and

T_{ws} = average tensile strength of the water-treated specimens, scorched.

If this loss is appreciable, there is some question as to whether the chlorine damage test is applicable. It is usually not necessary to determine the effect of wet chlorination on the fabric, as this factor is cancelled out in the calculation for chlorine damage. However, where it is desirable to determine the effect of the wet chlorination step, this may be calculated as follows:

$$(T_w - T_c)/T_w \times 100$$

= Percent tensile strength loss due to wet chlorination

where:

T_w = average tensile strength of the water-treated specimens, unscorched (handled as above) and

T_c = average tensile strength of the original fabric chlorinated and unscorched.

10.2 Any standard laboratory pH meter having suitable provision for high pH readings. Colorimetric methods cannot be used with NaOCl.

10.3 Available from SDL Atlas L.L.C., 1813A Associate Lane, Charlotte NC 28217; tel: 704/329-0911; fax: 704/329-0914; e-mail: info@sdlatlas.com.

10.4 Example: A Scott tensile strength tester having a suitable breaking-strength range (see ASTM D 76 and ASTM D 5035).

10.5 For determining the percent available chlorine, pipette a 1.00-mL portion of approx. 5% sodium hypochlorite solution into an Erlenmeyer flask and dilute to 100 mL with distilled water. Add 6 mL of 12% KI followed by 20 mL of 6N H₂SO₄. Titrate with 0.1N sodium thiosulfate solution and calculate as follows:

Percent available chlorine

$$= \frac{\text{mL Na thiosulfate} \times 0.1N \times 0.0355}{1 \text{ mL} \times \text{sp. grav. Na hypochlorite}} \times 100$$

10.6 Buffer Solution: Prepare a solution containing 290 g of sodium tetraphosphate and 93 g of monosodium phosphate (NaH₂PO₄ · H₂O) in sufficient water to make 1000 mL of solution.

10.7 Determine water volume at low-water level and use in calculating liquor-to-bath ratio.

10.8 Available from ASTM, 100 Barr Harbor Dr., West Conshohocken PA 19428; tel: 610/832-9500; fax: 610/832-9555.

10.9 The test block should exert a force of 255 g (9 oz), or 9 g/cm² (2 oz/in²). It can be calibrated by attaching a spring balance to the upper plate with a small thread sling and determine the force required to just separate the plates. If readjustment is necessary, follow instructions supplied by the manufacturer. Make sure that the two heating plates are clean and adjusted to give uniform contact at all points.

Electrostatic Clinging of Fabrics: Fabric-to-Metal Test

Developed in 1965 by AATCC Committee RA32; revised 1969, 1973, 2000; editorially revised 1974, 1976, 1977, 1978, 1991, 1999; reaffirmed 1977, 1980, 1989, 2005; editorially revised and reaffirmed 1986, 1995.

1. Purpose and Scope

1.1 This test method evaluates the relative clinging tendency of certain fabrics due to electrostatic charge generation. The test integrates the effect of fabric weight, stiffness, construction, surface character, finish application and other fabric parameters which affect the tendency of fabrics to cling.

2. Principle

2.1 Clinging of positively or negatively charged fabrics to the human body occurs due to instantaneous induction of an equal and opposite charge on the surface of the body when the charged fabric is brought close to it. A basic law of physics states that oppositely charged materials attract each other. A metal plate exhibits a similar phenomenon of instantaneous charge induction as would the human body when placed in the field of a charged material. Therefore, a metal plate can be used to simulate the problems of clinging observed between charged garments and the human body. Some individuals are more prone to electrostatic clinging than others, and a given individual may be more prone at one time than at another time. Therefore, fabric-to-metal cling times cannot be related directly to fabric-to-body clinging for different individuals.

2.2 In this test method, the time (t_d) is measured for the charge on a fabric specimen to decay to a level where the electrical attractive forces between the specimen and the metal plate are overbalanced by the gravitational forces of the specimen acting to pull the specimen away from the plate (see 12.6).

3. Terminology

3.1 **electrostatic clinging**, n.—adherence of one substance to another caused by an electrical charge on one or both surfaces.

4. Safety Precautions

NOTE: These safety precautions are for information purposes only. The pre-

cautions are ancillary to the testing procedures and are not intended to be all inclusive. It is the user's responsibility to use safe and proper techniques in handling materials in this test method. Manufacturers MUST be consulted for specific details such as material safety data sheets and other manufacturer's recommendations. All OSHA standards and rules must also be consulted and followed.

4.1 Good laboratory practices should be followed. Wear safety glasses in all laboratory areas.

4.2 The radioactive bar emits alpha radiation which is externally harmless to the human body. The radioactive isotope polonium 210 is toxic and precaution should be exercised to prevent ingestion or inhalation of the solid material. Do not take the radioactive bar apart or touch the radioactive strip under the grid. If the strip is touched or handled, wash hands thoroughly at once. Return the device to the manufacturer when it loses its effectiveness as a static eliminator for reactivation when tested in accordance with 12.3.1 or for disposal if use is to be discontinued. **Do not discard as scrap.**

5. Uses and Limitations

5.1 This test method is not intended for use in determining the suitability of fabric for use in hazardous areas where the electrostatic generation of sparks might result in fires or explosions.

5.1.1 Certain fabrics, particularly those of heavy construction, which do not exhibit a clinging propensity by this method might cling under some conditions of use.

5.1.2 This test method is primarily useful for determining clinging properties of lightweight apparel fabrics, such as those intended for use in lingerie.

6. Apparatus and Materials

6.1 Test plates.

6.1.1 Standard Test Plate—A test plate (see 12.2) is made by bending 100 × 450 mm strips of 18 gauge Type 304 stainless steel across the width 150 mm from one end so that an included angle of 1.22 ± 0.04 RAD is formed between the 100 × 150 mm base and the 100 × 300 upright plate. The grain of the finish should be such that the 450 direction of the test plate corresponds to the length or grain direction of the stainless steel sheets from which they are made. The face of the 100 × 300 plate must have a No. 4 finish (see

12.2.1) on the included angle side, and should be kept clean and smooth at all times. A fine line is indented across the test plate surface 230 mm from the top of the plate and this is used to position the lower edge of the specimen (see 12.2).

6.1.2 Variable Angle Experimental Test Plate—The sensitivity of this test depends on the included angle of the metal plate and can be diminished by decreasing the included angle or vice versa. A more versatile version of the test plate, suitable for research work, which allows facile change of the sensitivity, uses a 25 × 100 × 100 mm aluminum base with several slots machined into the base at different angles (e.g., 0.017, 0.087, 0.175, 0.35, 0.52, 0.70, 0.87, 1.05 RAD) from the vertical axis into which a 100 × 360 mm stainless steel plate fits (see 12.4).

6.2 Grounding Plate—This is a 200 × 360 mm, flat, 18 gauge Type 304 stainless steel plate, attached to a ground, such as a water pipe, with wire (e.g., No. 18 stranded, plastic-covered electronic wire). One such grounding plate is required for each test plate.

6.3 Radioactive bar (see 12.3).

6.4 Rubbing blocks, white pine, approx. 20 × 50 × 150 mm adjusted to weigh 65 g and with strips of 20 mm wide, double-faced tape on the ends of each block to attach ends of the rubbing fabric.

6.5 Polyurethane foam, 25 × 100 × 300 mm non-rigid, having a density of 21 kg/m³ and an ILD (Identification Load Deflection) firmness of 6.8 kg when tested (see 12.2 and 12.10) as directed in ASTM Method D 3574.

6.6 Clamps, metal (e.g., No. 3 Bulldog Clamp or Di-acro Toggle Clamp, see 12.4), with 70 mm edges covered with 20 mm electrical tape to prevent scratching of the surface of the test plates.

6.7 Stopwatch, with 0.01 min or one of equivalent precision marked in other units.

6.8 Forceps or tweezers, non-conducting, ivory-tipped, forceps used with analytical balances.

6.9 Oven, forced-draft type, capable of maintaining a temperature of $105 \pm 2^\circ\text{C}$.

6.10 Conditioning chamber, capable of providing relative humidity control of $40 \pm 2\%$ and temperature at $24 \pm 1^\circ\text{C}$ with circulating air.

6.10.1 If tests are to be conducted at relative humidities or temperatures other than $40 \pm 2\%$ RH and $24 \pm 1^\circ\text{C}$, the conditioning test chamber should be capable of providing the necessary range of test

conditions (such as 20-65 ± 2% RH and from 10-30 ± 1°C).

6.11 Rubbing fabrics.

6.11.1 Nylon rubbing fabric—100% spun nylon 6,6 (Style No. 361) (see 12.5).

6.11.2 Polyester rubbing fabric—100% spun polyester (Style No. 777) (see 12.5).

6.12 Fabric iron, domestic hand type, with appropriate settings (see Table I).

6.13 Cleaning solvent: halogenated hydrocarbon metal-cleaning solvent, such as DuPont's Vertrel MCA or Vertrel X-P10, hereinafter called HH Solvent (see 12.1).

7. Test and Rubbing Specimens

7.1 Test fabrics—Twelve 75 × 230 mm test specimens are required. Using die or scissors, cut six specimens with the longer dimension parallel to the warp, or wale, direction and six with the longer dimension parallel to the fill, or course, direction. (Do not cut fabric specimens with a hot soldering iron or heated wire since the edges can cause localized static problems due to heat degradation of the fibers and antistatic agents.)

7.2 Rubbing fabrics—Both nylon and polyester rubbing fabrics are required. Using die or scissors, cut six nylon and six polyester rubbing fabrics, each 75 × 230 mm, with the longer dimension parallel to the warp, or wale, direction of the fabric.

7.3 Do not contaminate the test specimens or the rubbing fabric by unnecessary handling or by allowing them to come in contact with transferable materials.

7.4 If either the test or rubbing fabric specimens do not lay completely flat, press them free of creases or wrinkles with a dry, clean iron at the appropriate setting as directed in Table I. Do not use test specimens with curled edges.

8. Conditioning

8.1 Since equilibration of a test specimen from the dry versus the wet condition relative to the humidity of the test chamber may show hysteresis, precondition the specimens from the dry side relative to the humidity in the test chamber. To accomplish this, place the test and rubbing specimens in the forced-draft oven at 105 ± 2°C for 30 min. Transfer them immediately to the controlled humidity chamber allowing no more than 15 s for the transfer.

8.2 Condition and test the test and rubbing specimens at 40 ± 2% RH and 24 ± 1°C in the controlled humidity chamber for at least 16 h. If the test is conducted at lower humidities (such as 30 ± 2% or at 20 ± 2%), or at higher humidities (such as 65 ± 2%), keep the temperature at 24 ± 1°C for standard testing. If other temper-

Table I—Safe Ironing Temperature Guide

Class 0	Class I 121-135°C	Class II 149-163°C	Class III 177-191°C	Class IV 204°C and Above
Below 121°C				
Modacrylic 93-121°C	Acetate		Nylon 6,6	Cotton
Olefin (Polyethylene) 79-121°C	Olefin (Polypropylene)	Acrylic Azlon Nylon 6	Polyester	Fluorocarbon
Rubber 82-93°C	Silk	Spandex Wool		Glass Hemp, Jute, Ramie
Saran 66-93°C				Linen Rayon, Viscose Triacetate (heatset)
Vinyon 54°C				

ature conditions are used for nonstandard testing, state the temperatures used in the report. For any humidity or temperature test conditions that are to be used, the test and rubbing specimens should be conditioned for at least 16 h (see 12.11).

9. Procedure

9.1 Clean the metal test plate before testing every different lot of fabric. To clean, swab with a facial tissue saturated with HH Solvent (wear protective gloves). Allow the plate to dry at least 5 min in the conditioning test chamber before using. Make sure that HH Solvent does not accumulate in the conditioning test chamber as a result of cleaning the metal test plate. If the No. 4 finish on the surface of the test plate is changed noticeably due to use, replace the test plate with a new one.

9.2 Handle the fabric test specimens and rubbing fabrics at only one marked corner to minimize transfer of impurities to the remainder of the fabric.

9.3 Adhere double-faced adhesive tape around all four 20 mm thick sides of the rubbing block. Completely discharge the rubbing fabric on both sides with the radioactive bar (*Caution*, see 4.2). Place a 50 × 150 mm side of wood block on the rubbing fabric in such a way that the 150 mm dimension of the block parallels the 230 mm dimension of the rubbing fabric and the block is centered on the fabric. Bring up the protruding edges of the fabric so that they adhere tightly to the double-faced tape on all four sides of the rubbing block. Take care that the double-faced tape does not extend to the area between the rubbing surface of fabric and the block.

9.4 Grasp a test specimen at one corner and allow it to hang free. Discharge both sides of the test specimen using the radioactive bar, holding the bar not over 25 mm away from the fabric as it moves up or down (*Caution*, see Section 4 and Fig. 1, Step A). Fasten the test specimen at the top of the long arm of the metal plate on

the 1.22 RAD included angle side with a metal bulldog or toggle clamp with the face of the test specimen out. Position the lower edge of the test specimen even with the indented line on the metal plate.

9.5 Attach the metal grounding plate with the wire to a suitable ground and place it horizontally in the controlled humidity chamber and lay the polyurethane foam on top.

9.6 Place the metal test plate with attached test specimen in a horizontal position on the polyurethane foam in such a way that the long arm of the plate completely rests on the polyurethane foam with the short arm of the test plate closest to the operator and pointing upward. The clamp should extend over the edge of the supporting foam so that the back of the plate is completely supported.

9.7 Place the rubbing block with attached rubbing fabric at the top of the plate so that the long axis of the rubbing fabric and the long axis of the test specimen are at right angles (see Fig. 1, Step B). The side of the rubbing block that does not expose the cut edge of the rubbing fabric should be down. Keep the test plate and rubbing block perfectly flat on their facing surfaces to ensure complete contact between test and rubbing fabrics during charge generation.

9.8 Place the middle fingers on the back edge of the rubbing block and pull the rubbing assembly the full length of the test specimen (see Fig. 1, Step C). Grasp the lock between the thumbs and middle fingers at the ends of the block, lift the assembly from the test specimen and return the rubbing assembly to its original position at the top of the test specimen. Repeat this rubbing sequence 12 times at a cycle of approx. 1 rubbing cycle per second. The total 12 rubbing cycles should be completed in no more than 15 s. For constant rubbing pressure, take care that the only downward pressure on the test specimen comes from the weight of the rubbing block and fabric.

9.9 Quickly place the assembly in an upright position on a grounded plate.

Grasp the lower right corner of the test specimen with the nonconducting tweezers (see Fig. 1, Step D), pull the unclamped part of the test specimen completely away from the metal specimen plate to a point where the test specimen is positioned vertically for ± 0.5 s (see Fig. 1, Step E), and then release the test specimen from the tweezers. Start the stopwatch immediately (see Fig. 1, Step F).

9.10 After every 30 ± 2 s, grasp the lower corner of the test specimen with nonconducting tweezers, pull the test specimen completely away from the metal plate to a point where the test specimen is positioned vertically for 1 ± 0.5 s, and then release the test specimen from the tweezers.

9.11 Record the time, to the nearest 0.1 min, for the fabric to decling of its own accord (see Fig. 1, Step G). Disregard any tendency for the test specimen to continue clinging within 25 mm of the bottom of the holding clamp.

9.11.1 If the time is greater than 10 min, discontinue the test and report t_d as >10 min (greater than 10 min). In some cases, a different “maximum cling time” period may be chosen. In this case, report the actual maximum cling time used for the testing.

9.11.2 If the test specimen declings *almost* completely but persists in clinging in a small localized area in addition to the area within 25 mm of the bottom of the holding clamp, discard and test an additional specimen. If this condition is observed in all test specimens, note and report the condition without assigning cling time.

9.12 Test three specimens in both warp (or wale) and filling (or course) directions against both nylon and polyester rubbing fabrics, using fresh test specimens and fresh rubbing fabric surfaces for each determination (see 12.3).

10. Report

10.1 Report the time (t_d) to the nearest 0.1 min required for a test specimen to decling from the metal plate as specified in 9.9 and 9.11.2. Report the three individual values of tests in both warp (or wale) and filling (or course) directions as well as an average of each of the three determinations, reporting separately the times (t_d) obtained with both nylon and polyester rubbing fabrics.

10.1.1 If the t_d value of two of a set of three test specimens is less than the selected maximum cling time selected from 9.11.1 but the t_d value of the third test specimen is greater than the selected maximum cling time, report the average of the two determinations which are less than the selected maximum cling time and disregard the t_d value of the third test specimen. Report that the third specimen

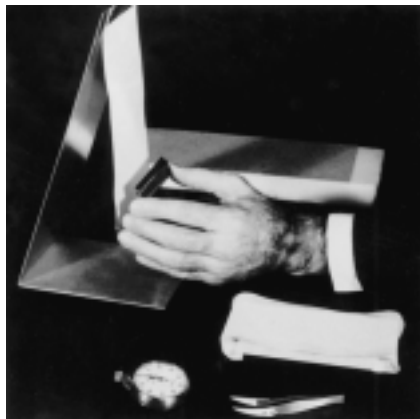

A



B



C



D



E



F

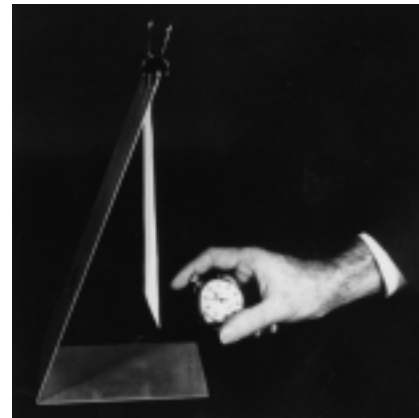

G

Fig. 1—Principal steps in conducting test.

exceeded the maximum cling time.

10.1.2 If the t_d value of two of a set of three test specimens is greater than the selected maximum cling time, report the t_d value as greater than the selected maximum cling time and disregard the t_d value of the third test specimen.

10.2 Report the percent relative humidity and the temperature at which the specimens were tested.

11. Precision and Bias

11.1 *Precision.* Extensive interlaboratory evaluations run in 1955 on woven fabrics indicated that, for the fabrics tested, the 95% confidence limits of this test are ± 0.5 min (see 12.6).

11.2 An interlaboratory test on tricot fabrics was run in 1975 which involved the following variables:

- 5 laboratories
- 4 fabrics
- 2 levels of laundering
- 2 fabric directions
- 2 relative humidities
- 2 types of nylon and 2 types of polyester rubbing fabrics

Based on the results of this study, the 95% confidence limits for the average decling time of a set of three observations, none of which exceeds the maximum cling time of 10 min, is ± 2.0 min for tests at 20% RH and ± 1.7 min for tests at 40% RH.

Some of the fabrics tested did not cling at all (0 min) while others clung more than the maximum 10 min, at which point testing is discontinued. In this interlaboratory test, 576 different test conditions were listed which involved 1,728 individual decling measurements. Of the 576 test conditions, 469 contain at least one 0 or 10 value. Only 109 contain no 0 or 10. Any set of these replicates containing a 0 or 10 cannot give a valid estimate of the experimental error (see 12.9).

11.3 *Bias.* Electrostatic clinging can be defined only in terms of a test method. There is no independent method for determining the true value. As a means of estimating this property, the method has no known bias.

12. Notes and References

12.1 HH Solvents: Vertrel® is a trademark of the DuPont Company, Wilmington, DE, and is available through their Fluoroproducts Division. Other suitable non-ozone-depleting halogenated hydrocarbon solvents and mixtures may be available from other suppliers. (Freon® 113, Genetron® 113, and similar products previously referenced by this test method are no longer available.)

12.2 Available from AATCC, P.O. Box 12215, Research Triangle Park NC 27709; tel: 919/549-8141; fax: 919/549-8933; e-mail: orders@aatcc.org.

12.2.1 The specified No. 4 finish on the standard test plate shall be as specified in the *ASTM Metals Handbook*, Vol. 2, 8th Edition; p 599 (1964) which states: "Following initial grinding with coarser abrasives, sheets are finally finished with lubricated 120-150 mesh abrasive belts." The resultant No. 4 finish surface roughness expressed in micro-inches is 45 maximum.

12.3 The Staticmaster Ionizing Unit is available from NRD, Inc., 2937 Alt Blvd. North, Grand Island NY 14072; tel: 716/773-7634.

12.3.1 Since the polonium in this radioactive element has a limited half life (approx. 6 months), the radioactive bar must be checked periodically to be sure that it is sufficiently active for complete removal of charge. The radioactive bar may be checked by testing a specimen known to exhibit a cling time of at least 10 min when tested as directed in Section 6. A jersey stitch nonantistatic heatset 40 denier nylon tricot fabric free of finish or scoured and in the range of 50-100 g/m² is satisfactory for this purpose. The fabric should be charged as directed and then deionized with the radioactive bar. If the test specimen shows zero cling time, the radioactive bar is sufficiently active for complete removal of charge.

12.4 Available from Carr Land Mfg. Co., 4200 Krause Ct., St. Louis MO 63119.

12.5 Available from Testfabrics Inc., P.O. Box 26, 415 Delaware St., W. Pittston PA 18643; tel: 570/603-0432; fax: 570/603-0433; e-mail: testfabric@aol.com (construction details available from AATCC, see 12.2).

12.6 For details, see *American Dyestuff Reporter* 56, pp 345-350 (1967).

12.7 The clinging behavior by this method of test of clean, finish-free 100% cotton fabrics can be used as a reference point for antistatic behavior of test fabrics of similar

construction and weights. Garments made from such clean, finish-free 100% cotton fabrics are generally considered to be free of clinging problems under use conditions. Some typical decling times for 100% cotton fabrics at 17% RH and 21°C are given in the reference cited in 12.6. S/400W, a standard bleached 80 × 80 cotton print cloth (available from Testfabrics Inc., see 12.5; or Textile Innovators Corp., see 12.10) can be used as a reference fabric in most instances.

12.8 Gayler, J., R. E. Wiggins, and J. B. Arthur, Department of Textile Technology, School of Textiles, North Carolina State University, "Static Electricity Generation, Measurement, and Its Effect on Textiles," pp 11-12 (May 1965).

12.9 The statistical analyses and related data are on file at AATCC, P.O. Box 12215, Research Triangle Park NC 27709; tel: 919/ 549-8141; fax: 919/549-8933; e-mail: orders@aatcc.org.

12.10 Available from SDL Atlas L.L.C., 1813A Associate Lane, Charlotte NC 28217; tel: 704/329-0911; fax: 704/329-0914; e-mail: info@sdlatlas.com.

12.11 At a given temperature, accumulation of static electricity generally is greater the lower the relative humidity (and vice versa). For example, fabrics which show a low degree of static accumulation at 40% RH and 24°C may exhibit severe static accumulation at 25% RH and 24°C while fabrics which exhibit static problems at 40% RH and 24°C may exhibit a low degree of static accumulation at 65% RH and 24°C. The relationship between the tendency for static accumulation and relative humidity varies with the specific antistatic agent, fiber, fabric construction, surface charger, etc. Therefore, although 40% RH and 24°C are the standard conditions for the test, significant information as to the probable antistatic performance properties of a fabric may require that tests be run also at a lower relative humidity, such as 20%, and 24°C, an atmospheric condition not unusual in modern heated and air conditioned buildings. Complete evaluation may also require tests at the upper level of 65% RH and 24°C.

12.12 Clinging in a small localized area can be indicative of the presence of foreign material or some irregularity and may not be characteristic of the clinging properties of the fabric lot from which the test specimens were taken.

12.13 Since several determinations sometimes can be run concurrently, time can be saved by having several test plates and grounding plates available.

Colorfastness to Crocking: Rotary Vertical Crockmeter Method

Developed in 1966 by AATCC Committee RA38; revised 1969, 1972, 1994, 1996, 2005; reaffirmed 1974, 1977, 1983, 1988, 1989; editorially revised 1981, 1985, 1986, 2002, 2004; editorially revised and reaffirmed 2001. Technically equivalent to ISO 105-X16.

1. Purpose and Scope

1.1 This test method is used to determine the amount of color transferred from the surface of colored textile materials to other surfaces by rubbing. It is applicable to textiles made from all fibers in the form of yarn or fabric, whether dyed, printed or otherwise colored and especially to prints where the singling out of areas smaller than possible to test with the standard AATCC Crockmeter (AATCC Method 8) is required (see 13.1 and 13.9).

1.2 Test procedures employing test squares either dry or wet with water or other liquids are within the scope of this method.

1.3 Since washing, drycleaning, shrinkage, ironing, finishing, etc., may affect the degree of color transfer from a material, the test may be made before or after, or before and after, any such treatment, depending upon the information desired.

2. Principle

2.1 A test specimen held at the base of the Rotary Vertical Crockmeter is rubbed with standard test squares under controlled conditions (see 13.1).

2.2 Color transferred to the test squares is assessed by a comparison with the Gray Scale for Staining or AATCC Chromatic Transference Scale (see 13.2).

3. Terminology

3.1 **colorfastness**, n.—the resistance of a material to change in any of its color characteristics, to transfer of its colorant(s) to adjacent materials or both, as a result of the exposure of the material to any environment that might be encountered during the processing, testing, storage or use of the material.

3.2 **crocking**, n.—a transfer of colorant from the surface of a colored yarn or fabric to another surface or to an adjacent area of the same fabric principally by rubbing.

4. Safety Precautions

NOTE: These safety precautions are

for information purposes only. The precautions are ancillary to the testing procedures and are not intended to be all inclusive. It is the user's responsibility to use safe and proper techniques in handling materials in this test method. Manufacturers MUST be consulted for specific details such as material safety data sheets and other manufacturer's recommendations. All OSHA standards and rules must also be consulted and followed.

4.1 Good laboratory practices should be followed. Wear safety glasses in all laboratory areas.

5. Apparatus and Materials

5.1 Rotary Vertical Crockmeter (see Fig. 1, 13.1 and 13.3).

5.2 Crockmeter Cloth—standard 51 × 51 mm (2 × 2 in.) test squares (see 13.3, 13.4).

5.3 AATCC Chromatic Transference Scale (see 13.5).

5.4 Gray Scale for Staining (see 13.5).

5.5 White AATCC Blotting Paper (see 13.5).

6. Verification

6.1 Verification checks on the operation of the test and the apparatus should be made routinely and the results kept in a log. The following observations and corrective actions are extremely important to avoid incorrect test results where abnormal crock images can result and influence the rating process.

6.2 Use an in-house poor crocking fabric as a calibration specimen and conduct three dry crock tests.



Fig. 1—Rotary vertical crockmeter.

6.2.1 A poor circular image with uneven dye pick-up may indicate the crocking finger needs resurfacing (see 13.6).

6.2.2 A double image may indicate a loose clip (see 13.6).

6.2.3 Scuff marks to the sides of the specimen indicate the loops to the wire clips are positioned downwards and are not high enough to prevent rubbing the specimen surface.

6.2.4 Confirm the wet pick-up techniques (see 9.2).

6.2.5 Replace the abrasive paper on the tester base if it is smooth to the touch in the crocking area compared to the adjacent area, or if slippage of the specimen is noticed (see 13.7).

7. Test Specimens

7.1 Materials of nearly any construction presenting a surface area of approximately 25 mm (1 in.) square or more can be tested.

8. Conditioning

8.1 Prior to testing, pre-condition and condition the test specimens and the crock squares for dry crock testing as directed in ASTM D 1776, Conditioning Textiles for Testing. Condition each specimen for at least 4 h in an atmosphere of $21 \pm 1^\circ\text{C}$ ($70 \pm 2^\circ\text{F}$) and $65 \pm 2\%$ RH by laying each test specimen or crock square separately on a screen or perforated shelf of conditioning rack.

9. Procedure

9.1 Dry Crocking Test.

9.1.1 Tilt the upper half of the machine away to allow access to the base of the machine. Place a test square on the end of the vertical rod and fasten it with spring clip.

9.1.2 Hold the test specimen on the machine base at the point the vertical rod contacts the base. Tilt the upper half of the machine back to the operating position with the test square at the end of the shaft in contact with the test specimen. Place the weight supplied with the Crockmeter on the vertical shaft to give the rubbing finger a downward force of $11.1\text{N} \pm 10\%$ ($40\text{ oz} \pm 10\%$).

9.1.3 With the left hand, hold the test specimen in position on the base. Turn the crank 20 turns with the right hand. This produces about 40 reciprocal turns of the vertical shaft.

9.1.4 Tilt the upper part of the machine back and remove the test specimen and the test square, condition and evaluate.

9.2 Wet Crocking Test.

9.2.1 Establish technique (see 13.8) for preparing wet crock cloth squares by weighing a conditioned square, then thoroughly wet out white testing square in distilled water. Prepare only one square at a time.

9.2.2 Weigh dry crock square. Using a syringe tube, graduated pipette or automatic pipetter, draw up water in mL to 0.65 times weight of crocking square. If crocking square weight equals 0.24 gm, the mL used would be $0.24 \times 0.65 = 0.16$ mL. Lay crocking square on white plastic mesh over a dish. Apply water evenly over crocking square and weigh the wet square. Calculate wet pickup according to instructions in AATCC Methods 8, Colorfastness to Crocking: AATCC Crockmeter Method, and 116. If needed, adjust the amount of water used to wet the square and using a new crocking square, repeat steps. When $65 \pm 5\%$ wet pickup is achieved, record the amount of water used. Draw up the recorded amount of water into the syringe tube, graduated pipette or automatic pipetter for each wet crocking performed during the current day. Repeat this process each day.

9.2.3 Avoid evaporative reduction of the moisture content below the specified level before the actual crock test is run.

9.2.4 Continue as directed in 9.1.

9.2.5 Air dry the white test square, then condition (see 8.1) before evaluating. In the case of napped, brushed or sanded material when loose fiber might interfere with the rating, remove the extraneous fibrous material by pressing lightly on the crock circle with the sticky side of cellophane tape before evaluating.

10. Evaluation

10.1 Rate the amount of color transferred from the specimen to the white test square under examination by means of the AATCC Chromatic Transference Scale or the Gray Scale for Staining (see 13.2, 13.5 and 13.10).

10.2 Back the test square with three layers of test cloth while evaluating.

10.3 It will be noted that the color transfer is usually greater near the edge of the tested circle than the center.

10.4 Rate the color transfer at the edge of the tested circle.

10.5 Rate dry and wet crocking fastness as follows:

Grade 5—negligible or no color transfer.

Grade 4.5—color transfer equivalent to Step 4-5 on the Gray Scale for Staining or Row 4.5 on the 9-step AATCC Chromatic Transference Scale.

Grade 4—color transfer equivalent to Step 4 on the Gray Scale for Staining or Row 4 on the 9-step AATCC Chromatic Transference Scale.

Grade 3.5—color transfer equivalent to Step 3-4 on the Gray Scale for Staining or Row 3.5 on the 9-step AATCC Chromatic Transference Scale.

Grade 3—color transfer equivalent to Step 3 on the Gray Scale for Staining or Row 3 on the 9-step AATCC Chromatic Transference Scale.

Grade 2.5—color transfer equivalent to Step 2-3 on the Gray Scale for Staining or Row 2.5 on the 9-step AATCC Chromatic Transference Scale.

Grade 2—color transfer equivalent to Step 2 on the Gray Scale for Staining or Row 2 on the 9-step AATCC Chromatic Transference Scale.

Grade 1.5—color transfer equivalent to Step 1-2 on the Gray Scale for Staining or Row 1.5 on the 9-step AATCC Chromatic Transference Scale.

Grade 1—color transfer equivalent to Step 1 on the Gray Scale for Staining or Row 1 on the 9-step AATCC Chromatic Transference Scale.

10.6 Average individual results to the nearest 0.1 grade when multiple specimens are tested or when a panel of evaluators rate color transfer.

11. Report

11.1 Report the grade determined in 10.5.

11.2 Indicate whether dry or wet test.

11.3 Indicate whether Gray Scale for Staining or AATCC Chromatic Transference Scale was used (see 13.2).

12. Precision and Bias

12.1 *Precision.* Precision for this test

method has not been established. Until a precision statement is generated for this test method, use standard statistical techniques in making any comparisons of test results for either *within-laboratory* or *between-laboratory* averages.

12.2 *Bias.* The true value of colorfastness to crocking can be defined only in terms of a test method. There is no independent method for determining the true value. As a means of estimating this property, the method has no known bias.

13. Notes

13.1 The Rotary Vertical Crockmeter provides a reciprocating rotary motion to the test finger and a selected pressure on the test finger.

13.2 It has been noted that different grades may result depending upon whether the Gray Staining Scale or AATCC Chromatic Transference Scale is used for the evaluation. It is, therefore, important to report which scale was used (see 11.3).

13.3 Available from Textile Innovators Corp., div. of SDL Atlas L.L.C., P.O. Box 8, 101 Forest St., Windsor NC; tel: 252/794-9703; fax: 252/794-9704; e-mail: tic@sdlatlas.com.

13.4 Available from Testfabrics Inc., P.O. Box 26, 415 Delaware St., W. Pittston PA 18643; tel: 570/603-0432; fax: 570/603-0433; e-mail: testfabric@aol.com.

13.5 Available from AATCC, P.O. Box 12215, Research Triangle Park NC 27709; tel: 919/549-8141; fax: 919/549-8933; e-mail: orders@aatcc.org.

13.6 The abrasive material currently supplied with the Rotary Vertical Crockmeter is "Wet or Dry Waterproof Silicon Carbide, W-320-A." Replacement pieces are available from Atlas Electric Devices Co. (see 13.3).

13.7 For very critical evaluations and in cases of arbitration, ratings must be based on the geometric gray scale for evaluating staining.

13.8 Experienced operators do not have to repeat this weighing procedure during a test session once the technique has been established.

13.9 Specimens tested by both test methods may show dissimilar results. There is no known correlation between the two methods.

13.10 An automated electronic grading system may be used as long as the system has been demonstrated to provide results that are equal to and provide equal or better repeatability and reproducibility than an experienced grader performing visual evaluation.

Colorfastness to Heat: Dry (Excluding Pressing)

Developed in 1966 by AATCC Committee RR54; revised 1967, 1971, 1973; editorially revised 1981, 1983, 1985, 1988, 2001, 2002; reaffirmed 1976, 1979, 1984, 1989; editorially revised and reaffirmed 1994, 1999, 2004. Technically equivalent to ISO 105-P01.

1. Purpose and Scope

1.1 This test method is intended for assessing the resistance of color of textiles of all kinds and in all forms to the action of dry heat, excluding pressing.

1.2 Several tests differing in temperature are provided; one or more of them may be used, depending on the requirements and the stability of the fibers.

1.3 When this test method is used for assessing color changes and staining in dyeing, printing and finishing processes it must be recognized that other chemicals and physical factors may influence the results.

2. Principle

2.1 A specimen of the textile in contact with specified undyed fabrics is exposed to dry heat by close contact with a medium which is heated to the required temperature. The change in color of the specimen and the staining of the undyed fabrics are assessed with standard gray scales.

3. Terminology

3.1 **colorfastness, n.**—the resistance of a material to change in any of its color characteristics, to transfer of its colorant(s) to adjacent materials or both, as a result of the exposure of the material to any environment that might be encountered during the processing, testing, storage or use of the material.

4. Safety Precautions

NOTE: These safety precautions are for information purposes only. The precautions are ancillary to the testing procedures and are not intended to be all inclusive. It is the user's responsibility to use safe and proper techniques in handling materials in this test method. Manufacturers MUST be consulted for specific details such as material safety data sheets and other manufacturer's recommendations. All OSHA standards and rules must also be consulted and followed.

4.1 Good laboratory practices should

be followed. Wear safety glasses in all laboratory areas.

5. Apparatus and Materials

5.1 Heating device providing even heat transfer at controlled temperatures by close contact to both sides of the specimen (see 12.1).

5.2 Two undyed fabrics, each of a size adapted to that of the heating device. One piece to be of the same kind of fiber as that of the textile to be tested or that predominating in the case of blends. The second piece shall be the second component of the blend or Multifiber Test Fabric No. 10A or FAA (see 12.5) or any other fabric of particular interest as specified in the test report.

5.3 Gray Scales for assessing change in color and staining (see 12.2).

5.4 AATCC Chromatic Transference Scale (see 12.2).

6. Test Specimen

6.1 If the textile to be tested is fabric, place a test specimen of a size adapted to that of the heating device between the two pieces of undyed fabric (see 5.2), and sew along one side to form a composite test specimen.

6.2 If the textile to be tested is yarn, knit it into fabric and treat it as in 6.1 or form a uniform layer of parallel lengths of it between the two pieces of undyed fabric (see 5.2), the amount of yarn taken being approximately equal to half the combined mass of the undyed fabrics. Sew along one side to hold the yarn in place and to form a composite test specimen.

6.3 If the textile to be tested is loose fiber, comb and compress an amount approximately equal to half the combined mass of the undyed fabrics into a uniform sheet of the required size, place the sheet between the two undyed fabrics and sew along one side to form a composite test specimen.

7. Procedure

7.1 Place the composite test specimen in the heating device and leave it there for 30 s at one of the following temperatures:

I	150 ± 2°C
II	180 ± 2°C
III	210 ± 2°C

The temperature(s) must be specified in the report (see 10.1). The pressure on the specimen should amount to 4 ± 1 kPa.

7.2 Remove the composite specimen and leave it for 4 h in air at the standard

temperature and atmosphere for testing; i.e., a temperature of 20 ± 2°C and relative humidity of 65 ± 2%.

7.3 Assess the change in color of the test specimen and the staining of the undyed fabrics (see 12.3).

8. Evaluation Method for Alteration in Color (Shade and Strength)

8.1 Rate the effect on the color of the test specimens by reference to the Gray Scale for Color Change:

Grade 5—negligible or no change as shown in Gray Scale Step 5.

Grade 4.5—change in color equivalent to Gray Scale Step 4-5.

Grade 4—change in color equivalent to Gray Scale Step 4.

Grade 3.5—change in color equivalent to Gray Scale Step 3-4.

Grade 3—change in color equivalent to Gray Scale Step 3.

Grade 2.5—change in color equivalent to Gray Scale Step 2-3.

Grade 2—change in color equivalent to Gray Scale Step 2.

Grade 1.5—change in color equivalent to Gray Scale Step 1-2.

Grade 1—change in color equivalent to Gray Scale Step 1.

9. Evaluation Method for Staining

9.1 Rate staining by the AATCC Chromatic Transference Scale or the Gray Scale for Staining (see 12.5):

Grade 5—negligible or no color transfer.

Grade 4.5—color transfer equivalent to Step 4-5 on the Gray Scale for Staining or Row 4.5 on the 9-step AATCC Chromatic Transference Scale.

Grade 4—color transfer equivalent to Step 4 on the Gray Scale for Staining or Row 4 on the 9-step AATCC Chromatic Transference Scale.

Grade 3.5—color transfer equivalent to Step 3-4 on the Gray Scale for Staining or Row 3.5 on the 9-step AATCC Chromatic Transference Scale.

Grade 3—color transfer equivalent to Step 3 on the Gray Scale for Staining or Row 3 on the 9-step AATCC Chromatic Transference Scale.

Grade 2.5—color transfer equivalent to Step 2-3 on the Gray Scale for Staining or Row 2.5 on the 9-step AATCC Chromatic Transference Scale.

Grade 2—color transfer equivalent to Step 2 on the Gray Scale for Staining or Row 2 on the 9-step AATCC Chromatic Transference Scale.

Grade 1.5—color transfer equivalent to Step 1-2 on the Gray Scale for Staining or Row 1.5 on the 9-step AATCC Chromatic Transference Scale.

Grade 1—color transfer equivalent to Step 1 on the Gray Scale for Staining or Row 1 on the 9-step AATCC Chromatic Transference Scale.

10. Report

- 10.1 Temperature of test.
- 10.2 Numerical rating of the change in color of the test specimen.
- 10.3 Numerical rating of the staining of each type of undyed fabric used.
- 10.4 Indicate whether Gray Scale for Staining or AATCC Chromatic Transference Scale was used for evaluating staining (see 12.4).

11. Precision and Bias

11.1 *Precision.* Precision for this test method has not been established. Until a precision statement is generated for this test method, use standard statistical techniques in making any comparisons of test results for either *within-laboratory* or

between-laboratory averages.

11.2 *Bias.* The colorfastness to dry heat (excluding pressing) can be defined only in terms of a test method. There is no independent method for determining the true value. As a means of estimating this property, the method has no known bias.

12. Notes

12.1 Heating device. One of the following devices may be used:

(a) A pair of electrically heated hot plates whose temperature is accurately controllable at temperatures over the specified range and which can be adjusted to provide a pressure on the specimen of 4 ± 1 kPa; e.g., Scorch Tester available from SDL Atlas L.L.C., 1813A Associate Lane, Charlotte NC 28217; tel: 704/329-0911; fax: 704/329-0914; e-mail: info@sdlatlas.com. In order to obtain the pressure specified in 7.1, the total area of the composite specimen should be at a suitable relationship to that of the plates so that the four spring loaded pins acting against the housing of the upper plate is utilized. This is accomplished by using a small diameter rod—e.g., a small allen wrench—to push the upper protruding end of each pin down through the plastic plate and then moving it slightly to one side so that the pin remains engaged against the underside of the plate. These spring loaded pins, when in

their normal up position, provide a counter balance to the weight of the upper plate and its housing so that the pressure between the plates is 8.8 g/cm^2 as called for in AATCC Method 92. Other similar devices providing identical test conditions and results may be used.

(b) Molten metal bath, in which a holder containing the composite specimen is immersed (see *The Journal of the Society of Dyers and Colourists*, 76, March 1960, p. 158).

12.2 Available from AATCC, P.O. Box 12215, Research Triangle Park NC 27709; tel: 919/549-8141; fax: 919/549-8933; e-mail: orders@aatcc.org.

12.3 A shade change for the undyed fabric may be caused by factors other than the dye. To determine this, pieces of the undyed fabric similarly treated shall be given the same test by itself.

12.4 For very critical evaluations and in the cases of arbitration, ratings must be based on the geometric Gray Scale for Staining.

12.5 Multifiber test fabric No. 10A is available from Testfabrics Inc., P.O. Box 26, 415 Delaware St., W. Pittston PA 18643; tel: 570/603-0432; fax: 570/603-0433; e-mail: testfabric@aol.com. Multifiber test fabric FAA is available from Textile Innovators Corp., div. of SDL Atlas L.L.C., P.O. Box 8, 101 Forest St., Windsor NC; tel: 252/794-9703; fax: 252/794-9704; e-mail: tic@sdlatlas.com.

Oil Repellency: Hydrocarbon Resistance Test

Developed in 1966 by AATCC Committee RA56; reaffirmed 1972, 1975, 1978, 1983, 1989, 2002; editorially revised 1985, 1986, 1990, 1995, 2004; revised 1992; editorially revised and reaffirmed 1997. Technically equivalent to ISO 14419.

1. Purpose and Scope

1.1 This test method is used to detect the presence of a fluorochemical finish, or other compounds capable of imparting a low energy surface, on all types of fabrics, by evaluating the fabric's resistance to wetting by a selected series of liquid hydrocarbons of different surface tensions.

2. Principle

2.1 Drops of standard test liquids, consisting of a selected series of hydrocarbons with varying surface tensions, are placed on the fabric surface and observed for wetting, wicking and contact angle. The oil repellency grade is the highest numbered test liquid which does not wet the fabric surface.

3. Terminology

3.1 **grade**, n.—*in textile testing*, the symbol for any step of a multistep standard reference scale for a quality characteristic.

NOTE: The grade is assigned to test specimens exhibiting a degree of the quality comparable to that step of the standard.

3.2 **oil repellency**, n.—*in textiles*, the characteristic of a fiber, yarn or fabric whereby it resists wetting by oily liquids.

4. Safety Precautions

NOTE: These safety precautions are for information purposes only. The precautions are ancillary to the testing procedures and are not intended to be all inclusive. It is the user's responsibility to use safe and proper techniques in handling materials in this test method. Manufacturers MUST be consulted for specific details such as material safety data sheets and other manufacturer's recommendations. All OSHA standards and rules must also be consulted and followed.

4.1 Good laboratory practices should be followed. Wear safety glasses and impervious gloves when handling test liquids in all laboratory areas.

4.2 The hydrocarbons specified in this method are flammable. Keep away from

heat, sparks and open flame. Use with adequate ventilation. Avoid prolonged breathing of vapor or contact with skin. Do not take internally.

4.3 Exposure to chemicals used in this procedure must be controlled at or below levels set by governmental authorities [e.g., Occupational Safety and Health Administration's (OSHA) permissible exposure limits (PEL) as found in 29 CFR 1910.1000 of January 1, 1989]. In addition, the American Conference of Governmental Industrial Hygienists (ACGIH) Threshold Limit Values (TLVs) comprised of time weighted averages (TLV-TWA), short term exposure limits (TLV-STEL) and ceiling limits (TLV-C) are recommended as a general guide for air contaminant exposure which should be met (see 12.1).

5. Uses and Limitations

5.1 This test method is not intended to give an absolute measure of the resistance of the fabric to staining by all oily materials. Other factors, such as composition and viscosity of the oily substances, fabric construction, fiber type, dyes, other finishing agents, etc., also influence stain resistance. This test can, however, provide a rough index of oil stain resistance, in that generally the higher the oil repellency grade, the better resistance to staining by oily materials, especially liquid oil substances. This is particularly true when comparing various finishes for a given fabric.

6. Apparatus and Materials

6.1 Test liquids prepared and numbered according to Table I (see 12.2).

6.2 Dropping bottles (see 12.3).

6.3 White AATCC Textile Blotting Paper (see 12.4).

6.4 Laboratory gloves (general purpose is sufficient).

7. Test Specimens

7.1 Test two specimens approximately 20 × 20 cm (8 × 8 in.) from each sample. Condition the test specimens for a minimum of 4 h at 21 ± 1°C (70 ± 2°F) and 65 ± 2% RH prior to testing.

8. Procedure

8.1 Place the test specimen flat on the white textile blotting paper on a smooth, horizontal surface.

8.1.1 When evaluating open weave of "thin" fabrics, conduct the test on at least two layers of the fabric; otherwise, the test liquid may wet the underlying surface, not the actual test fabric, and thereby cause confusion in the reading of the results.

8.1.2 Equipment, benches and gloves must be free of silicone. Use of silicone containing products could adversely affect the oil repellency grade.

8.2 Wearing clean laboratory gloves, brush the pile of napped or pile fabrics with your hand in the direction giving the greatest lay of the surface prior to placing the drops of the test liquid.

8.3 Beginning with the lowest-numbered test liquid (AATCC Oil Test Grade Liquid No. 1), *carefully* place small drops [approximately 5 mm (0.187 in.) in diameter or 0.05 mL volume] on the test specimen in five locations along the filling direction. The drops should be approximately 4.0 cm (1.5 in.) apart. The dropper tip should be held at a height of approximately 0.6 cm (0.25 in.) from the fabric surface while placing drops. DO NOT TOUCH THE FABRIC WITH THE DROPPER TIP. Observe the drops for 30 ± 2 s, from approximately a 45° angle.

8.4 If no penetration or wetting of the fabric at the liquid-fabric interface and no wicking around the drops occur, place drops of the next higher-numbered test liquid at an adjacent site on the fabric and again observe for 30 ± 2 s.

8.5 Continue this procedure until one of the test liquids shows obvious wetting or wicking of the fabric under or around the drop within 30 ± 2 s.

9. Evaluation

9.1 The AATCC Oil Repellency Grade of a fabric is the numerical value of the highest-numbered test liquid which will

Table I—Standard Test Liquids

AATCC Oil Repellency Grade Number	Composition
0	None (Fails Kaydol)
1	Kaydol
2	65:35 Kaydol: n-hexadecane by volume
3	n-hexadecane
4	n-tetradecane
5	n-dodecane
6	n-decane
7	n-octane
8	n-heptane

not wet the fabric within a period of 30 ± 2 s. A grade of zero (0) is assigned when the fabric fails the Kaydol test liquid. Wetting of the fabric is normally evidenced by a darkening of the fabric at the liquid-fabric interface or wicking and/or loss of contact angle of the drop. On black or dark fabrics, wetting can be detected by loss of "sparkle" within the drop.

9.2 Different types of wetting may be encountered depending on the finish, fiber, construction, etc.; and the determination of the end point can be difficult on certain fabrics. Many fabrics will show complete resistance to wetting by a given test liquid (as indicated by a clear drop with a high contact angle, see Fig. 1, Example A) followed by immediate penetration by the next higher-numbered test liquid. In these instances the end point, and oil repellency grade, is obvious. However, some fabrics will show progressive wetting under several test liquids as evidenced by a partial darkening of the fabric at the liquid-fabric interface (see Fig. 1, Examples B, C and D). For such fabrics, the point of failure is considered to be that test liquid which exhibits complete darkening of the interface or any wicking within 30 ± 2 s.

9.3 A **failure** occurs when three (or more) of the five drops applied from a given test liquid show complete wetting (Fig. 1 [D]) or wicking with loss of contact angle (Fig. 1 [C]). A **pass** occurs if three (or more) of the five drops applied show clear well rounded appearance with high contact angle (Fig. 1 [A]). The grade is expressed as the integer value of the pass test liquid immediately prior to the

fail test liquid. A **borderline pass** occurs if three (or more) of the five drops applied show the rounded drop with partial darkening of the test specimen (Fig. 1 [B]). The grade is expressed to the nearest 0.5 value determined by subtracting one-half from the number of the borderline pass test liquid.

10. Report

10.1 The oil repellency grade should be measured on two separate specimens. If the two grades agree, report the value. When the two grades are not in agreement, a third determination should be made. Report the grade of the third determination if that value is the same as either of the first two determinations. When the third determination is different from either of the first two, report the median value. For example, if the first two grades are 3.0 and 4.0 and the third determination is a 4.5 value, report the median value of 4.0. Report the oil repellency grade to the nearest 0.5 value (see Fig. 1).

11. Precision and Bias

11.1 *Summary.* Interlaboratory tests were conducted in September 1990 and April 1991 to establish the precision of this test method. The September interlab involved two participants at each of nine laboratories rating two specimens of each of four fabrics each day for three days. The grades of this interlab were concentrated into the 1-2 and 4-5 regions of the scale. The April interlab was conducted with fabrics responding in the 2-3 and 5-7

portions of the scale. This interlab involved two participants at each of seven laboratories rating two specimens of each of two fabrics each day for two days. (Day interaction was shown not to be a significant factor in the analysis of the September interlab.) Results from both interlabs were combined for precision and bias statements. All materials necessary for the interlabs were provided to each laboratory by AATCC including the standard test liquids. A video cassette of the grading procedure prepared at the AATCC Technical Center by the subcommittee and visual examples of pass, borderline and fail conditions were included in the protocol. The fabrics were limited to polyester/cotton materials. The unit of measure was the median of the grades of the two (or three) specimens rated each day.

11.2 The components of variance as standard deviations of the oil repellency grade were calculated to be as follows:

AATCC Oil Repellency Test	
Single operator	0.27
Between operators/ within laboratories	0.30
Between laboratories	0.39

11.3 *Critical differences.* For the components of variance in 11.2, two observations should be considered significantly different at the 95% probability level if the difference equals or exceeds the critical differences shown in Table II.

11.4 *Bias.* The true value of the oil repellency grade can only be defined in terms of this test method. Within this limitation, this test method has no known bias.

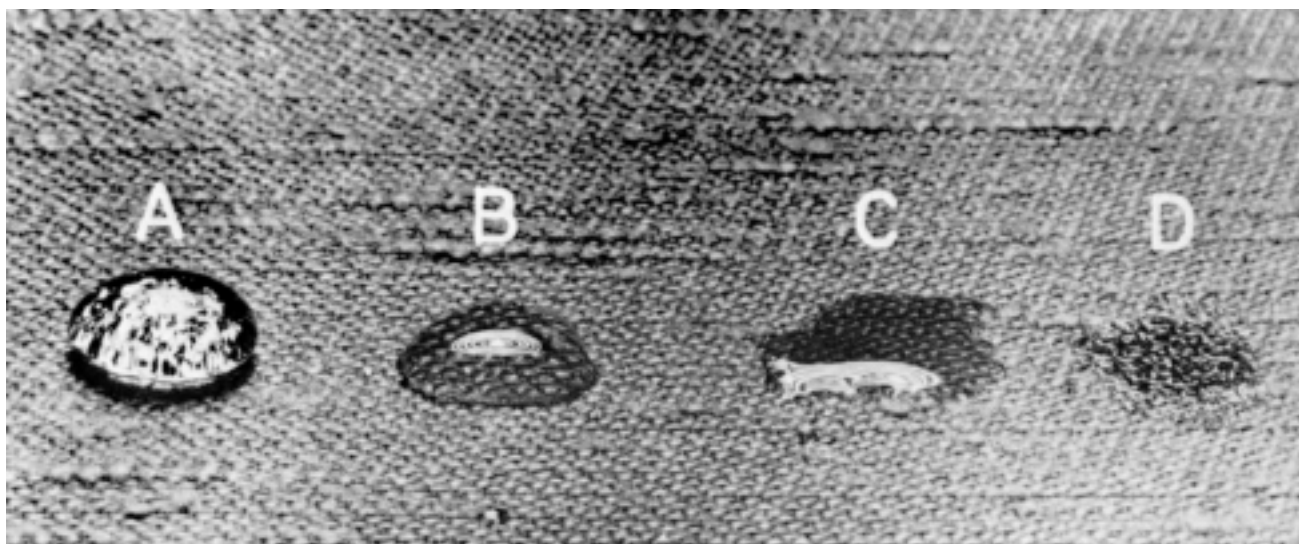

A = Passes; clear well-rounded drop
 B = Borderline pass; rounding drop with partial darkening
 C = Fails; wicking apparent and/or complete wetting
 D = Fails; complete wetting

Fig. 1—Grading example.

Table II—Critical Differences^a

No. of Observations ^b	Single Operator	Within Laboratory	Between Laboratory
1	0.75	1.12	1.55
2	0.53	0.99	1.45
3	0.43	0.94	1.42

^a The critical differences were calculated using $t - 1.950$, which is based on infinite degrees of freedom.

^b An observation is a unit of measure obtained from the median of the grades for 2 (or 3) specimens.

12. Notes

12.1 Available from Publications Office, ACGIH, Kemper Woods Center, 1330 Kemper Meadow Dr., Cincinnati OH 45240; tel: 513/742-2020.

12.2 Kaydol™ is available from CBM Group of N.C. Inc., 1308 N. Ellis Ave., Dunn NC 28334; tel: 910/892-8985; fax: 910/

892-5701; or Textile Innovators Corp., div. of SDL Atlas L.L.C., P.O. Box 8, 101 Forest St., Windsor NC; tel: 252/794-9703; fax: 252/794-9704; e-mail: tic@sdlatlas.com. All other hydrocarbon liquids should be laboratory quality available through most chemical supply houses. One source is ACROS Organics. That concern's catalog designations are as follows:

Test Liquid	Catalog Number	Specified Melting Point or Boiling Point Range	N*
n-hexadecane	AC120461000	17-18°C	27.3
n-tetradecane	ICN15677580	4-6°C	26.4
n-dodecane	ICN19515880	-10.5--9.0°C	24.7
n-decane	ICN19512380	173-175°C	23.5
n-octane	AC129375000	124-126°C	21.4
n-heptane	ICN15732380	98-99°C	19.8
Kaydol	NC9112099	348°C	31.5

*N = dynes/cm at 25°C

To order these liquids call 800/766-7000 or go online at www.acros.com.

12.3 For convenience, it is desirable to transfer the test liquids from stock solutions to dropping bottles, each marked with the appropriate AATCC Oil Repellency Grade number. A typical system found useful consists of 60 mL dropping bottles with ground-in pipettes and Neoprene bulbs. Prior to use the bulbs should be soaked in heptane for several hours and then rinsed in fresh heptane to remove soluble substances. It has been found helpful to place the test liquids in sequential order in a wooden platform on the grading table. NOTE: Purity of test liquids does affect surface tension of the liquid. Use only analytical grades of test liquids.

12.4 Available from AATCC, P.O. Box 12215, Research Triangle Park NC 27709; tel: 919/549-8141; fax: 919/549-8933; e-mail: orders@aatcc.org.

Color Change Due to Flat Abrasion (Frosting): Screen Wire Method

Developed in 1967 by AATCC Committee RA29; reaffirmed 1970, 1974, 1977, 1989, 1999, 2004; editorially revised and reaffirmed 1979, 1984, 1994; editorially revised 1980, 1985, 1986, 1997.

1. Purpose and Scope

1.1 This test method (see 11.1) is intended for evaluating the resistance of colored fabrics to change in shade caused by flat abrasion. It can be used for all colored fabrics, but is especially sensitive to the color change of durable press cross-dyed blend fabrics, in which one fiber is abraded away faster than another.

1.2 The test method produces in an accelerated manner, a localized color change similar to that produced on some garments over relatively short periods of actual wear in which the garment is exposed to relatively mild abrasive action (see 11.2).

2. Principle

2.1 The fabric specimen is mounted over a foam rubber cushion and rubbed multidirectionally against a wire screen mounted on a weighted head. Any change in the color of the specimen is evaluated by comparison with the Gray Scale for Color Change.

3. Terminology

3.1 **abrasion**, n.—the wearing away of any part of a material by rubbing against another surface.

3.2 **frosting**, n.—in textiles, a change of fabric color caused by localized abrasive wear. (Syn: *differential wear*, *fibrillation*).

NOTE: Frosting may be the result of differential wear, as in multicomponent blends in which the fibers do not match in shade, or of the abrasion of single-fiber constructions in which there is a variation in or incomplete penetration of dye.

4. Safety Precautions

NOTE: These safety precautions are for information purposes only. The precautions are ancillary to the testing procedures and are not intended to be all inclusive. It is the user's responsibility to use safe and proper techniques in handling materials in this test method. Manufacturers MUST be consulted for specific

details such as material safety data sheets and other manufacturer's recommendations. All OSHA standards and rules must also be consulted and followed.

4.1 Good laboratory practices should be followed. Wear safety glasses in all laboratory areas.

4.2 Manufacturer's safety recommendations should be followed when operating laboratory testing equipment.

5. Apparatus and Materials

5.1 A schematic diagram of the frosting unit is shown in Fig. 1.

5.2 CSI Stoll—Universal Wear Tester Model CS-22C, or CSI Surface Abrader Model CS-59 (see 11.3 and Fig. 2).

5.3 Circular frosting specimen holder (see 11.3 and 11.4).

5.4 Rubber O ring (see 11.3).

5.5 Conical mounting piece (see 11.3).

5.6 Abradant, stainless steel wire

screening, 16 mesh, 0.23 mm wire (see 11.3).

5.7 Side clamps (see 11.3).

5.8 Gray Scale for Color Change (with intermediate steps) (see 11.5).

6. Test Specimens

6.1 Cut a minimum of two 127 × 127 mm specimens from each sample (see 11.6). No specimen shall be taken from within one-tenth of the width of the fabric from either selvage.

6.2 Condition the specimens under standard conditions of 65 ± 2% RH and 21 ± 1°C until they reach equilibrium.

7. Procedure (see 11.7 and 11.8)

7.1 Conduct the test in the standard atmosphere for testing textiles.

7.2 Remove the circular surface abra-

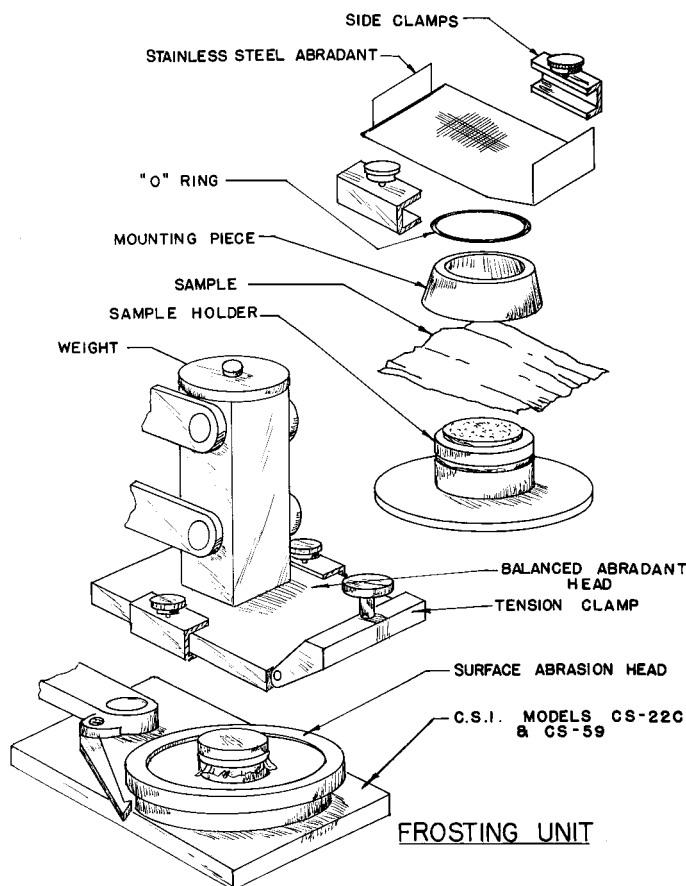

Fig. 1—Schematic drawing of frosting unit.



Fig. 2—C.S.I. Surface Abrader prepared for frosting test.

sion head from the reciprocating table of the abrasion tester by removing the circular locking stud in the center. Use the special two-pronged wrench supplied with the Frosting Unit.

7.3 Insert circular frosting specimen holder in surface abrasion head, place the metal O ring over specimen holder, and lock in place with screw collar.

7.4 Place the test specimen face up and centrally over the specimen holder, and then place the conical mounting piece over the specimen. (This mounting piece holds the specimen over the foam rubber cushion and facilitates the insertion of the rubber O ring over the test specimen into the groove. The rubber O ring holds the sample firmly in place without distortion during the test.) Insert the rubber O ring over the specimen into the groove, and remove the mounting piece.

7.5 Replace the surface abrasion head holding the test specimen onto the reciprocating table.

7.6 Attach the stainless steel screen (see 11.9) to the abradant plate by clamping screen ends in the abradant plate. Apply necessary tension by means of the front tension clamp. Secure sides with side clamps.

7.7 Apply head weights totaling 1134 g to the balanced abradant head (see 11.10).

7.8 Adjust rotary motor pawl to rotate the surface abrasion head approximately one revolution per 100 cycles.

7.9 Gently lower the head until it contacts the test specimen and push the "start" button. Abrade for 1200 cycles and stop the machine.

7.10 Remove abrasion head with the abraded specimen and remove the test specimen.

7.11 Hand rinse the test specimen in clear lukewarm water at 38°C to remove detritus; blot between towels to remove excess water.

7.12 Place specimen face down between two pieces of clean white cotton cloth and press with a hand iron set at approximately 149°C until dry.

8. Evaluation

8.1 Examine the abraded specimen under north sky light or an equivalent light source with illumination of at least 538 lx on the specimen surface.

8.2 Place the specimen flat on the viewing table with the illumination overhead. The light should be sufficiently diffused so that shadows are not caused by viewing the specimen from overhead. The specimen should remain stationary and the viewer assume the angle of viewing. First, view the specimen with the warp direction in the line of sight by scanning the specimen at angles from 0.2-1.57 RAD (15-90°) overhead. Then turn the specimen and repeat for the filling direction.

8.3 Rate the color change by comparing with the Gray Scale for Color Change and record the lowest grade observed for each specimen in accordance with the following scale:

Grade 5—negligible or no change as shown in Gray Scale Step 5.

Grade 4.5—change in color equivalent to Gray Scale Step 4-5.

Grade 4—change in color equivalent to Gray Scale Step 4.

Grade 3.5—change in color equivalent to Gray Scale Step 3-4.

Grade 3—change in color equivalent to Gray Scale Step 3.

Grade 2.5—change in color equivalent to Gray Scale Step 2-3.

Grade 2—change in color equivalent to Gray Scale Step 2.

Grade 1.5—change in color equivalent to Gray Scale Step 1-2.

Grade 1—change in color equivalent to Gray Scale Step 1.

8.4 Report the average grade for specimens from each sample.

9. Report

9.1 Report the average grade and the number of specimens tested.

10. Precision and Bias

10.1 *Interlaboratory Test Data.* Interlaboratory tests were conducted in 1966 and 1967 in which five laboratories each made two observations on each of eight fabrics. The components of variance, ex-

pressed as standard deviations, were calculated to be: *Within-laboratory* component, 0.3 Gray Scale units; *Between-laboratory* component, 0.5 Gray Scale units.

10.2 *Precision.* For the components of variance reported in 10.1, two averages of observed values should be considered significantly different at the 95% probability level if the difference equals or exceeds the critical differences listed in Table I.

10.3 *Bias.* No justifiable statement on bias can be made since the true value cannot be established by an independent method.

11. Notes

11.1 This test method was developed by an industry committee, and was known as the Industry Committee Test. For additional information about this method, see A Proposed Test Method to Evaluate Frosting Potential Caused by Abrasive Wear, *American Dyestuff Reporter*, Vol. 54, No. 24, 42-9, 1965.

11.2 See AATCC 120 (Emery Method) for a test designed to simulate the effect of relatively severe abrasion action.

11.3 This equipment may be obtained from SDL Atlas L.L.C., 1813A Associate Lane, Charlotte NC 28217; tel: 704/329-0911; fax: 704/329-0914; e-mail: info@sdlatlas.com. The stainless steel screen should be obtained from this standard source since there may be differences in the screen wire obtained from other sources.

11.4 When the specimen holder with the foam rubber cushion is first received, or after it has been used extensively, the plane of the surface of the rubber head may not be in perfect alignment with the abradant plate. This may lead to poor or uneven wear pattern. Such a condition can be rectified by abrading the rubber surface (without specimen) on the tester with "0" emery cloth under a 1134 g head weight.

11.5 The Gray Scale for Color Change (with intermediate steps) may be ordered from AATCC, P.O. Box 12215, Research Triangle

Table I—Critical Difference, Gray Scale Units, For the Conditions Noted*

Number of Observations in Each Average	Within-Laboratory Precision	Between-Laboratory Precision
2	0.4	1.4
4	0.3	1.4
8	0.2	1.4

*The critical differences were calculated using $t = 1.960$, which is based on infinite degrees of freedom.

Note: The tabulated values of the critical differences should be considered a general statement. The above is a general statement, particularly with respect to between-laboratory precision. Before a meaningful statement can be made about two specific laboratories, the amount of statistical bias, if any, between them must be established with each comparison being based on recent data obtained on randomized specimens from one sample of the material to be tested.

Park NC 27709; tel: 919/549-8141; fax: 919/549-8933; e-mail: orders@aatcc.org.

11.6 For the optimum number of specimens, unless otherwise agreed upon (for instance, provided for by an applicable materials specification), test the number of test specimens required to secure a precision of the mean of the test result of ± 0.5 units on the Gray Scale at a probability level of 95%, calculated as follows:

$$n = 15.4 \sigma^2$$

where:

n = number of test specimens and
 σ = standard deviation of results for individual specimens determined from extensive past records on similar material.

The number of specimens required for a precision or a probability other than that specified above can be calculated as directed in ASTM Method D 2905, Number of Speci-

mens Required to Determine the Average Quantity of a Textile.

If σ is not known, test four specimens for *within-laboratory* determinations; test nine specimens for *between-laboratory* determinations.

The number of tests prescribed above is based on $\sigma = 0.5$ Gray Scale units for single-operator, single-laboratory results, and $\sigma = 0.75$ Gray Scale units for *between-laboratory* results, somewhat higher values of σ than will usually be found in practice. Knowledge of the correct σ is, therefore, likely to permit testing fewer than the number of specimens specified above.

11.7 To obtain information pertinent to the behavior of the fabric in actual use, it may sometimes be desirable to pretreat test specimens, as by laundering, before subjecting them to the frosting test.

11.8 At regular intervals, check the operation of the frosting tester with one or more

standard fabrics of known frosting properties. A satisfactory calibration test fabric has not yet been found by AATCC Committee RA29.

11.9 It is imperative that the warp of the abradant screen be parallel to the reciprocating motion of the upper head. A new screen should be washed initially to remove oil. It is recommended that after each test the stainless steel abradant screen be cleaned of detritus with a compressed air gun with a safety nozzle. It is also recommended that the screen be washed periodically in a mild detergent to remove possible build-up of matter which cannot be blown off with an air gun. Worn or defective wire screen abradant should be replaced promptly.

11.10 A balanced head will neither fall forward nor tilt backward when not loaded with weights. If the head is not balanced, the abrasion pressure between screen and fabric will be altered.

Color Change Due to Flat Abrasion (Frosting): Emery Method

Developed in 1967 by AATCC Committee RA29; reaffirmed 1970, 1974, 1977, 1989, 1999, 2004; editorially revised and reaffirmed 1980, 1984, 1994, 2004; editorially revised 1986, 1997.

1. Purpose and Scope

1.1 This test method (see 10.1) is intended for evaluating the resistance of colored fabrics to changes in shade caused by flat abrasion. It can be used for all colored fabrics, but is especially sensitive to poor dye penetration in all-cotton fabrics and to abrasion-caused changes in color of union-dyed blends.

1.2 The test method produces, in an accelerated manner, a localized color change similar to that produced on some garments over relatively long periods of actual wear in which the garment is exposed to relatively severe abrasion action (see 10.2).

2. Principle

2.1 The fabric specimen is mounted over a diaphragm inflated under controlled air pressure and rubbed multidirectionally against an emery abrasant surface mounted on a weighted head. Any change in color of the specimen is evaluated by comparison with the Gray Scale for Color Change.

3. Terminology

3.1 **abrasion**, n.—the wearing away of any part of a material by rubbing against another surface.

3.2 **frosting**, n.—*in textiles*, a change of fabric color caused by localized abrasive wear. (Syn: *differential wear, fibrillation*).

NOTE: Frosting may be the result of differential wear, as in multicomponent blends in which the fibers do not match in shade, or of the abrasion of single-fiber constructions in which there is a variation in, or incomplete penetration of dye.

4. Safety Precautions

NOTE: These safety precautions are for information purposes only. The precautions are ancillary to the testing procedures and are not intended to be all inclusive. It is the user's responsibility to use safe and proper techniques in handling

materials in this test method. Manufacturers MUST be consulted for specific details such as material safety data sheets and other manufacturer's recommendations. All OSHA standards and rules must also be consulted and followed.

4.1 Good laboratory practices should be followed. Wear safety glasses in all laboratory areas.

4.2 Manufacturer's safety recommendations should be followed when operating laboratory testing equipment.

5. Apparatus and Materials

5.1 CSI Stoll-Universal Wear Tester Model CS-22C, or CSI Surface Abrader Model CS-59 (see 10.3).

5.2 Rubber diaphragm without electrical contact point (see 10.3).

5.3 "O" emery polishing paper, 3.8 × 22.8 cm (see 10.4).

5.4 Vacuum cleaner.

5.5 Gray Scale for Color Change (see 10.5).

6. Test Specimens

6.1 Cut two circular specimens approximately 10.8 cm in diameter. No specimen shall be taken within one-tenth of the width of the fabric from either selva.

6.2 Condition the specimens under standard conditions of $65 \pm 2\%$ relative humidity and $21 \pm 1^\circ\text{C}$ until they reach equilibrium.

7. Procedure (see 10.6 and 10.7)

7.1 Conduct the test in the standard atmosphere for testing textiles.

7.2 Place an unused strip of "O" emery abrasive paper beneath the abrasant plate and clamp at each end. Apply the minimum amount of tension on the paper that is necessary to make it lie flat against the lower surface of the abrasant plate.

7.3 Place the test specimen (face up) over the rubber diaphragm (without electrical contact) so that the fabric is free from wrinkles. Clamp the test specimen against the diaphragm with the clamping ring, taking care not to distort the fabric.

7.4 Set the air pressure on the diaphragm to 20.68 kPa, and place a 1361 g load on the balanced head (see 10.8).

7.5 Engage the rotation mechanism of the specimen clamp to cause multidirectional abrasion on the specimen.

7.6 Gently lower the upper carriage

with the "O" emery paper until it contacts the specimen, and push the "start" button. (The lower carriage should oscillate at a speed of approximately 120 cycles/min).

7.7 Allow the carriage to oscillate for 100 continuous cycles, and then stop the machine.

7.8 Remove the test specimen from the machine and vacuum it to remove fiber and abrasant residue.

7.9 Hand rinse the test specimen in clear lukewarm water at 38°C to remove remaining detritus; blot between towels to remove excess water.

7.10 Place specimen face down between two pieces of clean white cotton cloth and press with a hand iron set at approximately 149°C until dry.

7.11 If a specimen slips in the clamp, the air pressure does not remain constant or an abnormal wear pattern is obtained, discard the specimen and repeat the test on an additional specimen (see 10.7).

8. Evaluation

8.1 Examining the abraded specimen under north sky light or an equivalent light source with illumination of at least 538 lx on the specimen surface.

8.2 Place the specimen flat on the viewing table with the illumination overhead. The light should be sufficiently diffused so that shadows are not caused by viewing the specimen from overhead. The specimen should remain stationary and the viewer assume the angles of viewing. First, view the specimen with the warp direction in the line of sight by scanning the specimen at angles from 0.27-1.57 RAD ($15\text{-}90^\circ$) overhead. Then turn the specimen and repeat for the filling direction.

8.3 Rate the color change by comparing with the Gray Scale for Color Change and record the lowest grade observed for each specimen in accordance with the following scale:

Grade 5—negligible or no change as shown in Gray Scale Step 5.

Grade 4.5—change in color equivalent to Gray Scale Step 4-5.

Grade 4—change in color equivalent to Gray Scale Step 4.

Grade 3.5—change in color equivalent to Gray Scale Step 3-4.

Grade 3—change in color equivalent to Gray Scale Step 3.

Grade 2.5—change in color equivalent to Gray Scale Step 2-3.

Grade 2—change in color equivalent to Gray Scale Step 2.

Grade 1.5—change in color equivalent to Gray Scale Step 1-2.

Grade 1—change in color equivalent to Gray Scale Step 1.

8.4 Report the average for two specimens.

9. Precision and Bias

9.1 *Precision.* Precision for this test method has not been established. Until a precision statement is generated for this test method, use standard statistical techniques in making any comparisons of test results for either *within-laboratory* or *between-laboratory* averages.

9.2 *Bias.* The color change due to flat abrasion, frosting, emery method, can be defined only in terms of a test method.

There is no independent method for determining the true value. As a means of estimating this property, the method has no known bias.

10. Notes

10.1 This test method was developed from the Celanese Corporation's test procedure APD; EL 9C, and was known as the Celanese Test.

10.2 See AATCC Method 119 (Screen Wire Method) for a test designed to simulate the effect of relatively mild abrasive action.

10.3 This equipment is available from SDL Atlas L.L.C., 1813A Associate Lane, Charlotte NC 28217; tel: 704/329-0911; fax: 704/329-0914; e-mail: info@sdlatlas.com.

10.4 It is suggested that to minimize variability of results Behr-Manning Company's O emery abrasive paper be used and is available from SDL Atlas L.L.C., 1813A Associate Lane, Charlotte NC 28217; tel: 704/

329-0911; fax: 704/329-0914; e-mail: info@sdlatlas.com.

10.5 The Gray Scale for Color Change is available from AATCC, P.O. Box 12215, Research Triangle Park NC 27709; tel: 919/549-8141; fax: 919/549-8933; e-mail: orders@aatcc.org.

10.6 To obtain information pertinent to the behavior of the fabric in actual use, it is sometimes desirable to pretreat test specimens, as by laundering, before subjecting them to the frosting test.

10.7 At regular intervals, check the operation of the frosting tester with one or more standard fabrics of known frosting properties. A satisfactory calibration test fabric has not yet been found by AATCC Research Committee RA29 on Abrasion Resistance.

10.8 A balanced head will neither fall forward nor tilt backward when not loaded with weights. If the head is not balanced, the abrasion pressure between screen and fabric will be altered.

Carpet Soiling: Visual Rating Method

Developed in 1967 by AATCC Committee RA57; reaffirmed 1970, 1973, 1976, 1979, 1982, 1989, 2000, 2005; editorially revised 1986, 1991; editorially revised and reaffirmed 1987; revised 1995.

1. Purpose and Scope

1.1 This test method covers the measurement of the degree of cleanness of pile floor coverings, in the range from clean to a middle degree of soiling. It can be used to measure the accumulation of soil, or the removal of soil by a cleaning procedure. It can be used with pile floor coverings of any color, pattern, structure or fiber content.

1.2 This test method does not evaluate structural appearance changes (see 14.1).

2. Principle

2.1 The degree of difference in cleanness between an original or clean area, and the area under examination is determined by visual matching with a stepwise series of differences in gray chips selected to form a geometrical scale of differences on the light-dark axis.

3. Terminology

3.1 **carpet**, n.—all textile floor coverings not designated as rugs.

3.2 **cleanness**, n.—in *carpet soiling tests*, the absence of change in appearance due to soil, specifically the degree to which the specimen approaches the original clean, unsoiled condition.

NOTE: Cleanness is independent of changes of physical structure which may be present because of exposure to traffic or action of cleaning procedures.

3.3 **soil**, n.—dirt, oil or other substances not normally intended to be present on a substrate such as a textile material.

3.4 **soiling**, n.—in *textiles*, a process by which a textile substrate becomes more or less uniformly covered with/or impregnated with soil.

3.5 **textile floor covering**, n.—an article having a use-surface composed of textile material and generally used for covering floors.

3.6 **use-surface**, n.—of *textile floor covering*, the part of a textile floor covering directly exposed to foot traffic.

4. Safety Precautions

NOTE: These safety precautions are for information purposes only. The pre-

cautions are ancillary to the testing procedures and are not intended to be all inclusive. It is the user's responsibility to use safe and proper techniques in handling materials in this test method. Manufacturers MUST be consulted for specific details such as material safety data sheets and other manufacturer's recommendations. All OSHA standards and rules must also be consulted and followed.

4.1 Good laboratory practices should be followed. Wear safety glasses in all laboratory areas.

5. Uses and Limitations

5.1 The complex surface structure of pile floor coverings, the depth of the pile and its compressibility make it difficult to specify a method of measurement of reflectance appropriate for all classes of pile floor covering or for comparison between classes. The interpretation of differences in reflectance, particularly for materials of different color or original reflectance, is also uncertain. The present method avoids both sets of difficulties by obtaining comparison of one difference, that between clean and soiled, with a standardized scale of difference in reflectance, by visual recognition of equivalent magnitudes of difference.

6. Apparatus

6.1 Gray Scale for Color Change or Jumbo Gray Scale for Color Change (preferable for large samples), including intermediate half steps (see 14.2). This scale contains nine pairs of gray chips, ranging from Step 5, no difference, a pair of dark gray chips, to Step 1, the largest difference represented. Each pair contains one of the dark gray chips of Step 5. The chips are mounted on a sliding rule in a dark cover, which has a window through which one pair may be seen at a time.

7. Verification of Gray Scales

7.1 Visual verification. Inspection of the Gray Scales should show a recognizable, approximately-equal, apparent difference between each successive pair. If such visual stepwise progression is apparent, the scale is satisfactory. The Gray Scale must be clean for proper evaluation.

7.2 Reflectance measurement. If there is doubt about the visual test, it may be checked by reflectance measurement. Use any reflectance measuring equipment appropriate to chip size (10 × 38 mm). The measured reflectance for each

of the chips of Grade 5 and each of the reference chips of all the other pairs should differ from their average by less than one-half the difference between the pair in Step 4 for a nine-step scale which includes half steps. The difference between reflectances of the chips in a pair, when plotted on semilog paper against the grade step or half step, should form a straight line. The difference between chips at the 4-5 step may be in line with the others since this difference is on the order of the variation in the Grade 5 chips. If the other steps form a regular series, the 4-5 step is less critical.

8. Preparation of Specimens

8.1 Clean reference specimen. Use a specimen of original or clean carpet large enough to show any pattern of structure of color in a representative way. If there are light and dark colors, be sure to locate the light colors at an edge. Cut a sharp edge on the reference specimen.

8.2 Leave the soiled floor covering, or the floor covering after cleaning, intact on the floor, or cut out a specimen convenient for handling. If a specimen is cut, use a portion which is representative of the exposure to soil or to the cleaning process, as well as representative of the pattern, and which includes the lighter colors.

9. Conditioning

9.1 Use the prevailing room conditions. Be sure that the floor covering is dry, within normal regain, if on-location cleaning methods have been used.

10. Procedure

10.1 Place the clean reference specimen on the specimen to be examined, or beside it, with no gap between the specimens. Orient the two specimens in the same way with respect to the structure and pattern. Use a standard lighting system which may include a daylight and artificial light source. Any other lighting should be standardized as much as possible for visual testing.

10.2 Compare the pairs of chips in the Gray Scale with the pair of specimens, until the nearest corresponding pair of chips has been found. Use the dark shield to expose only one pair of chips at a time.

10.3 Record the number of the step or half step which most nearly corresponds in difference to the difference in cleanness between the specimens. Keep in mind that it is degree of difference which

is being matched; do not attempt to match gray shades in the less clean specimen on the Gray Scale.

10.4 Repeat the ratings with at least four observers. For greater precision, use five or six observers. Arrange that no observer knows the ratings given by other observers. If observers who do not have previous experience with this method are used, give practice by going through a set of three or more comparisons, including the full range of differences which are to be compared, without recording the ratings, before doing the series of ratings which is recorded.

11. Calculation of Results

11.1 Average the ratings given by the four or more observers, to the nearest 0.1 scale unit.

12. Report

12.1 Report the average grade of clean-

ness, and the number of observers, on the scale from 5, no difference from clean standard, to 1, the largest difference in the reference scale.

13. Precision and Bias

13.1 The variance (the square of the standard deviation) of ratings given the same specimen by different observers ranges from 0.2 for experienced observers to 0.5 for learners. Values of 0.3-0.4 are likely. From this, four to six observers are required to ensure that a difference of 0.5 scale units will be reported by another similar group of observers at the 95 or 90% confidence level.

13.2 Information on differences between laboratories is limited but variations from 0.2-0.5 scale units have been encountered.

13.3 The bias of the test method can be considered in terms of its definition as a means of measuring magnitude of subject-

ive appreciation of a difference in cleanliness by means of a geometric scale of physical differences. The results obtained are by definition subjectively accepted as valid for different structures, patterns and colors, and show general correlation with reflectance measurements on any one type of floor covering, if the original reflectance is high. For darker colors, the visual rating is independent of change of reflectance.

14. Notes

14.1 Procedures for the determination of change of the structural aspects of appearance caused by traffic are covered in ASTM Method D 2401, Test for Service Change of Appearance of Pile Floor Coverings, available from ASTM, 100 Barr Harbor Dr., West Conshohocken PA 19428; tel: 610/832-9500; fax: 610/832-9555.

14.2 Available from AATCC, P.O. Box 12215, Research Triangle Park NC 27709; tel: 919/549-8141; fax: 919/549-8933; e-mail: orders@aatcc.org.

Carpet Soiling: Service Soiling Method

Developed in 1967 by AATCC Committee RA57; reaffirmed 1970, 1973, 1976, 1979, 1982, 1989, 2000; editorially revised 1985, 1990; editorially revised and reaffirmed 1987, 1995.

1. Purpose and Scope

1.1 This test method evaluates the service soiling of carpets and rugs.

2. Principle

2.1 Specimens of carpets and selected control samples are exposed to normal foot traffic in a controlled test area. The test specimens and controls are removed and visually rated at predetermined intervals corresponding to different degrees of soiling or exposure to soiling.

3. Terminology

3.1 **carpet**, n.—all textile floor coverings not designated as rugs.

3.2 **soil**, n.—dirt, oil or other substances not normally intended to be present on a substrate such as a textile material.

3.3 **soiling**, n.—*in textiles*, a process by which a textile substrate becomes more or less uniformly covered with/or impregnated with soil.

3.4 **textile floor covering**, n.—an article having a use-surface composed of textile material and generally used for covering floors.

3.5 **use-surface**, n.—*of textile floor covering*, the part of a textile floor covering directly exposed to foot traffic.

4. Safety Precautions

NOTE: These safety precautions are for information purposes only. The precautions are ancillary to the testing procedures and are not intended to be all inclusive. It is the user's responsibility to use safe and proper techniques in handling materials in this test method. Manufacturers MUST be consulted for specific details such as material safety data sheets and other manufacturer's recommendations. All OSHA standards and rules must also be consulted and followed.

4.1 Good laboratory practices should be followed. Wear safety glasses in all laboratory areas.

5. Soiling Location

5.1 The soiling location shall be sufficiently removed from any street or other

outside area so that the specimen will not be subjected to wet traffic. A distance of at least 15 m (50 ft) is suggested.

5.2 It shall be sufficiently isolated from greasy, oily or other nontypical soiling which might be present in factory areas and the like.

5.3 The traffic pattern in the soiling area shall be such that all specimens are subjected to all of the traffic as in the case of a narrow aisle or passageway with access only at either end or, alternately, if the traffic cannot be so confined or directed, it shall be randomized to such a degree as to produce the effect of uniform soiling.

5.4 In the case of the long narrow arrangement with traffic only in two opposite directions, a 4 m (12 ft) length of buffer carpet shall be installed at both ends of the test area. For other arrangements, or where there is a random traffic pattern, the buffer carpet shall be installed around the perimeter of the test specimens and may extend for a proportionately shorter distance but in no case for less than 6 ft in any direction. The buffer carpet may be of any available fiber or construction but should be light in color in order to avoid errors due to the transfer of fiber or dyestuff to the test specimens.

6. Carpet Specimens

6.1 Specimen size. The size of the test specimens shall be 30 × 30 cm (12 × 12 in.).

6.2 Specimen mounting. The carpet specimens shall be stapled to 12 mm (0.5 in.) marine plywood panels using a heavy duty staple gun (see 13.1). Other suitable methods of fastening the carpet specimens may be used. The panel shall then be mounted in a recessed frame with the

sides of the frame beveled and with a thin sheet of hardboard attached to the underside to add rigidity. The carpet panels are not fastened in place but remain unattached so that they may be readily shifted or removed.

7. Arrangement and Rotation of Specimens

7.1 The requirements are related to the dimensions and traffic pattern of the particular soiling area. Therefore, it is not possible to propose a procedure which will be universally applicable. Specimen rotation is necessary to achieve uniform soiling.

7.2 However, to illustrate the principles involved and to meet the conditions of the most common situation, we propose to use the case of the long, narrow corridor. In this illustrative case there are 24 specimens in the test and in such an area it is not usually feasible to use a greater width than 68.5 cm (27 in.). This would correspond to a 2 × 12 arrangement as shown in Table I. The numbers refer in this case to the various carpets (including control samples) and the letters refer to replicates so that specimen 1a is the first replicate of Carpet 1.

7.3 The procedure for moving and rotating the specimens shall be as follows:

7.3.1 For the first six days of the test move each adjacent set of specimens (1a and 5b) two positions in a lengthwise direction.

7.3.2 After the sixth day and until the completion of the test, advance each set of specimens one position each day.

7.3.3 Each time the specimens are moved, rotate the individual specimens 90° in a clockwise direction.

7.3.4 Finally, and in addition to the above, move the lengthwise rows from

Table I—Arrangement of Carpet Specimens for Service Soiling

1st day		2nd day		3rd day		4th day		5th day		6th day	
1a	5b	7c	3b	1b	5c	3c	7a	5a	1c	7b	3a
2a	6b	8c	4b	2b	6c	4c	8a	6a	2c	8b	4a
3a	7b	5b	1a	3b	7c	5c	1b	7a	3c	1c	5a
4a	8b	6b	2a	4b	8c	6c	2b	8a	4c	2c	6a
5a	1c	7b	3a	1a	5b	7c	3b	1b	5c	3c	7a
6a	2c	8b	4a	2a	6b	8c	4b	2b	6c	4c	8a
7a	3c	1c	5a	3a	7b	5b	1a	3b	7c	5c	1b
8a	4c	2c	6a	4a	8b	6b	2a	4b	8c	6c	2b
1b	5c	3c	7a	5a	1c	7b	3a	1a	5b	7c	3b
2b	6c	4c	8a	6a	2c	8b	4a	2a	6b	8c	4b
3b	7c	5c	1b	7a	3c	1c	5a	3a	7b	5b	1a
4b	8c	6c	2b	8a	4c	2c	6a	4a	8b	6b	2a

left to right and vice versa with each successive rearrangement of the specimens.

8. Soiling Levels

8.1 The standard levels of soiling must be predetermined prior to conducting the service soiling test. For general use of this test the soiling intervals may correspond to those required to obtain soiling levels of an arbitrarily selected carpet (control sample) exposed to give a light, medium and high degree of soil (see 13.2). Each laboratory should select and prepare control soiled samples consistent with the needs of the laboratory. If two or more laboratories are involved, identical control samples should be available for each laboratory.

8.2 Test and control specimens are removed from the test pattern at specified intervals corresponding to different degrees of soiling or exposure to soiling.

9. Specimen Removal at Predetermined Soiling Levels

9.1 Remove all the "a" specimens as the first group whenever the "a" control test specimen matches the soiled control sample (first soiling level). This is done regardless of the appearance of the "b" and "c" specimens at that time. A comparison within each set of "a," "b" and "c" specimens is to be made, however, and recorded.

9.2 Remove the "b" and "c" specimens and control samples in a similar manner at the second and third soiling levels, respectively.

9.3 As each soiling level is reached, replace spaces left vacant by the removal of test and control specimens. Use portions of the buffer carpet for this purpose.

9.4 Compare the control sample with the control soiled sample daily as soon as possible after vacuuming. Once the decision is made to remove a set of specimens, vacuum the set immediately before they are removed from the test area. Soiling continues with the specimens being advanced one position each day.

9.5 Records of the traffic count and the duration of the test may be maintained.

10. Maintenance

10.1 Clean the test specimens daily using an upright motor-driven brush-type of vacuum cleaner.

10.1.1 A proper cleaning shall consist of eight passes of the cleaner over a particular area of the carpet. The first pass when starting shall be away from the operator, the second back toward the operator. The last stroke shall be back toward the operator. On the next adjacent section of the specimen to be cleaned, the first stroke shall be away from the operator. Overlaps due to the width of the specimen not being an even multiple of the cleaner shall be ignored.

10.2 While the above procedure may be conducted by maintenance people rather than laboratory personnel, it is strongly recommended that the laboratory assure itself that proper cleaning procedures are used and that the vacuum cleaner is functioning properly throughout the test period.

11. Evaluation

11.1 Visual evaluation can be used to determine differences in degrees of soiling (see AATCC Method 121, Carpet Soiling: Visual Rating Method).

12. Precision and Bias

12.1 *Precision.* Precision for this test method has not been established. Until a precision statement is generated for this test method, use standard statistical techniques in making any comparisons of test results for either *within-laboratory* or *between-laboratory* averages.

12.2 *Bias.* Carpet soiling (service soiling method) can be defined only in terms of a test method. There is no independent method for determining the true value. As a means of estimating this property, the method has no known bias.

13. Notes

13.1 The Arrow Tacker, Model T-50, made by the Arrow Fastener Company, 1 Junius St., Brooklyn NY, has been found to be satisfactory. This stapler will handle sizes from 6.3 mm (0.25 in.) to 14.3 mm (0.562 in.) but the 9.5 mm (0.375 in.) size is usually satisfactory on most fabrics. However, the staple should penetrate the wood at least 4.8 mm (0.187 in.) for best results.

13.2 In the work of Committee RA57, the soiling levels were defined by nylon cut-pile carpet samples soiled to three different levels (light, medium, heavy).

Carpet Soiling: Accelerated Soiling Method

Developed in 1967 by AATCC Committee RA57; editorially revised 1974, 1985, 1990, 1991; reaffirmed 1970, 1973, 1976, 1979, 1982, 1989, 2000; revised 1988; editorially revised and reaffirmed 1995.

1. Purpose and Scope

1.1 This test method describes a procedure for the accelerated soiling of carpets. It can be used to compare the soiling propensity of two or more carpets; or it can be used to soil carpets as a preliminary step in measuring either the ability of a carpet to be cleaned or the efficiency of a cleaning process. This accelerated carpet soiling method has been found to give results similar to floor service soiling, but its use is recommended only as a screening method and not as a replacement for floor testing.

2. Principle

2.1 Specimens of carpet are tumbled together with prepared synthetic soil (see Sections 7 and 8) in a laboratory ball mill for a predetermined time.

3. Terminology

3.1 **carpet**, n.—all textile floor coverings not designated as rugs.

3.2 **soil**, n.—dirt, oil or other substances not normally intended to be present on a substrate such as a textile material.

3.3 **soiling**, n.—*in textiles*, a process by which a textile substrate becomes more or less uniformly covered with/or impregnated with soil.

3.4 **textile floor covering**, n.—an article having a use-surface composed of textile material and generally used for covering floors.

3.5 **use-surface**, n.—*of textile floor covering*, the part of a textile floor covering directly exposed to foot traffic.

3.6 **accelerated soiling, service soiling**, and other key terms will be added when definitions are agreed upon.

4. Safety Precautions

NOTE: These safety precautions are for information purposes only. The precautions are ancillary to the testing procedures and are not intended to be all inclu-

sive. It is the user's responsibility to use safe and proper techniques in handling materials in this test method. Manufacturers MUST be consulted for specific details such as material safety data sheets and other manufacturer's recommendations. All OSHA standards and rules must also be consulted and followed.

4.1 Good laboratory practices should be followed. Wear safety glasses in all laboratory areas.

4.2 Manufacturer's safety recommendations should be followed when operating laboratory testing equipment.

5. Apparatus and Materials

5.1 Jar mill, laboratory, ball, roller type, direct motor driven, 1 L (1 qt) (see 13.1).

5.2 Jar, ball, mill, porcelain, approx. 1 L (1 qt) (see 13.2).

5.3 Flint pebbles, 1.9-2.5 cm (0.8-1.0 in.) diam (see 13.3).

5.4 Soils.

5.4.1 Soil (vacuum cleaner sweepings) (see Section 7).

5.4.2 Synthetic soil (see Section 8).

5.5 Vacuum cleaner: tank type; 120 volts; 750 watts; 50-60 cycles; use fabric or upholstery attachment.

6. Test Specimens

6.1 Cut two specimens, each 18 cm (7 in.) in warp direction of tufting and 9 cm (3 in.) in filling direction or across tufting direction.

6.2 Condition specimens at room temperature for 16 h prior to use.

7. Soil Preparation

7.1 Take sweepings from a vacuum cleaner. For maximum reproducibility use sweepings from several vacuum cleaners within the surrounding area of the testing facilities.

7.2 Pass sweepings through a 20-mesh screen and then through a 100-mesh screen.

7.3 Take soil which finally passes through the 100-mesh screen and sterilize it (for health reasons) by steaming for 30 min; then air dry.

7.4 Mix soil thoroughly and set aside sufficient quantity to complete the series of tests.

7.5 Do not store soil for more than 4 months.

8. Synthetic Soil Preparation

8.1 Synthetic Soil Formulation:

Ingredient	% by Weight
Peat moss (dark).....	38
Portland cement.....	17
Kaolin clay.....	17
Silica (200 mesh).....	17
Carbon black (lamp or furnace black).....	1.75
Red iron oxide.....	0.50
Mineral oil (medicinal grade).....	8.75

8.1.1 Peat moss should be dry and free of lumps.

8.1.2 Portland cement must be dry. If it contains lumps, discard and use fresh supply.

8.1.3 Mix all dry ingredients together thoroughly before adding mineral oil. Dry mix at 50°C (122°F) for 6-8 h.

8.1.4 Place dry mixture in ball mill with ceramic balls. Turn mill on and run for approximately 24 h.

8.1.5 Store mixture in vapor tight containers with a desiccant.

9. Soiling Levels

9.1 Soiling levels are predetermined on an arbitrarily selected carpet (control sample) soiled to give light, medium and heavy degrees of soil (see 13.4) preferably by exposure to a service soiling test (see 13.5).

9.2 Soiling times in the ball mill are determined by soiling unsoiled specimens of the control sample to match the levels of soiling established with soiled control specimens according to 9.1.

9.3 Carpet specimens under evaluation are soiled for given times established in 9.2.

10. Soiling Procedures

10.1 Place two specimens in the mill jar (see 5.2) with the back of each specimen against the inside cylindrical surface of the jar.

10.2 Place 10 g of soil on the face of the carpet specimens as uniformly as possible.

10.3 Add 50 flint pebbles in the porcelain jar and fasten cover to jar.

10.4 Rotate the jar and contents on the ball mill at 250-300 rpm.

10.5 At the end of the predetermined soiling time remove carpet specimens and clean excess soil from carpet specimens by light vacuuming with the tank-type vacuum cleaner. Five strokes with the vacuum cleaner attachment in each direction should be adequate. Clean all specimens in the same manner.

11. Evaluation of Results

11.1 It is recommended that AATCC Method 121, Carpet Soiling: Visual Rating Method, be used for evaluation.

11.1.1 It may be necessary to use a visual panel evaluation if time or available equipment does not permit evaluation by AATCC Method 121.

12. Precision and Bias

12.1 *Precision.* Precision for this test method has not been established. Until a precision statement is generated for this test method, use standard statistical tech-

niques in making any comparisons of test results for either *within-laboratory* or *between-laboratory* averages.

12.2 *Bias.* Carpet soiling (accelerated soiling method) can be defined only in terms of a test method. There is no independent method for determining the true value. As a means of estimating this property, the method has no known bias.

13. Notes

13.1 Suitable jar mill is Cat. No. 3440-E05 available from Thomas Scientific, 99 High Hill Rd. at I-295, P.O. Box 99, Swedesboro NJ 08085-0099; tel: 800/345-2100. Equivalent jar

mills are available from other laboratory supply companies.

13.2 Suitable jar is Cat. No. 3440-F15, Size 00, available from Thomas Scientific (see 13.1).

13.3 Suitable flint pebbles are Cat. No. 10484, Large, available from VWR Scientific, P.O. Box 66929, O'Hare AMF, Chicago IL 60666; tel: 800/932-5000. Equivalent pebbles are available from other laboratory supply companies.

13.4 In the work of Committee RA57, Floor Covering Test Methods, the soiling levels were defined by nylon cut-pile carpet samples soiled to three different levels (light, medium and heavy).

13.5 See AATCC Method 122, Carpet Soiling: Service Soiling Method.

Appearance of Fabrics after Repeated Home Laundering

Developed in 1967 by AATCC Committee RA61; revised 1969, 1975, 1982, 1989 (with title change), 1992, 1996, 2005; editorially revised 1974, 1983, 1985, 1988, 1991, 1997, 2004; reaffirmed 1973; editorially revised and reaffirmed 1978, 1984, 2001. Technically equivalent to ISO 7768.

1. Purpose and Scope

1.1 This test method is designed to evaluate the smoothness appearance of flat fabric specimens after repeated home laundering.

1.2 Any washable fabric may be evaluated for smoothness appearance using this method.

1.3 Fabrics of any construction, such as woven, knit and nonwoven, may be evaluated according to this method.

2. Principle

2.1 Flat fabric specimens are subjected to standard home laundering practices. A choice is provided of hand or machine washing, alternative machine wash cycles and temperatures, and alternative drying procedures. Evaluation is performed using a standard lighting and viewing area by rating the appearance of specimens in comparison with appropriate reference standards.

3. Terminology

3.1 **ballast**, n.—*in procedures for processing or testing of textiles*, material that is used to bring the total weight or volume of the textiles to an amount specified in the procedure.

3.2 **dryer creases**, n.—sharp folds or lines running in any direction in a laundered or dried specimen.

NOTE: Dryer creases are an unintended result of restricted movement of specimens in the washer or the dryer.

3.3 **durable press**, adj.—having the ability to retain substantially the initial shape, flat seams, pressed-in creases and unwrinkled appearance during use and after laundering or drycleaning.

3.4 **laundering**, n.—*of textile materials*, a process intended to remove soils and/or stains by treatment (washing) with an aqueous detergent solution and normally including rinsing, extracting and drying.

3.5 **smoothness appearance**, n.—*in fabrics*, the visual impression of planarity of a specimen quantified by comparison

with a set of reference standards.

4. Safety Precautions

NOTE: These safety precautions are for information purposes only. The precautions are ancillary to the testing procedures and are not intended to be all inclusive. It is the user's responsibility to use safe and proper techniques in handling materials in this test method. Manufacturers MUST be consulted for specific details such as material safety data sheets and other manufacturer's recommendations. All OSHA standards and rules must also be consulted and followed.

4.1 Good laboratory practices should be followed. Wear safety glasses in all laboratory areas.

4.2 The 1993 AATCC Standard Reference Detergent may cause irritation. Care should be taken to prevent exposure to skin and eyes.

4.3 All chemicals should be handled with care.

4.4 Manufacturer's safety recommendations should be followed when operating laboratory testing equipment.

5. Uses and Limitations

5.1 This test method is designed to be used only for evaluating the appearance of washable fabrics after repeated home laundering.

5.2 The test procedure is designed to reflect the capabilities of home laundry equipment which is currently used by consumers. In general, it is preferable to conduct the test under relatively severe laundering conditions.

5.3 Prints and patterns may mask the mussiness present in fabrics. The rating process is, however, based on the visual appearance of specimens including such effects.

5.4 The small specimen sizes used for fabric tests occasionally will cause wrinkles or creases (dryer creases) to develop which are not considered to be characteristic of fabric performance in use. Precautions are given in the text of the method to reduce the occurrence of dryer creases.

5.5 The interlaboratory reproducibility of the results of this test method depends upon mutual agreement by users of the method on the washing and drying conditions as outlined in 8.1.

6. Apparatus and Materials

6.1 Automatic washing machine (see

12.1).

6.2 Automatic tumble dryer (see 12.1).

6.3 Drip dry and line dry facilities.

6.4 A 9.5 L (10.0 qt) pail.

6.5 Detergents.

6.5.1 1993 AATCC Standard Reference Detergent, powder (see 12.2 and 12.8).

6.5.2 2003 Standard Reference Detergent, liquid (see 12.2).

6.6 Ballast of $92 \times 92 \pm 3$ cm ($36 \times 36 \pm 1$ in.) hemmed pieces of bleached cotton sheeting (Wash load ballast type 1) or 50/50 polyester/cotton plain weave (Wash load ballast type 3) (see 12.3).

6.7 Lighting and evaluation area in an otherwise darkened room using the overhead lighting arrangement shown in Fig. 1 (see 12.4). It has been the experience of many observers that light reflected from the side walls near the viewing board can interfere with the rating results. It is recommended that the side walls be painted matte black (85° gloss less than 5 units) or that blackout curtains be mounted on both sides of the viewing board to eliminate the reflective interference.

6.8 Standard AATCC Three-Dimensional Smoothness Appearance Replicas, set of six (see Fig. 2 and 12.2).

6.9 Steam or dry iron with appropriate fabric temperature settings.

6.10 Detergent (for hand wash).

6.11 Scale with at least 5 kg or 10 lb capacity.

7. Test Specimens

7.1 Three representative 38×38 cm (15×15 in.) fabric specimens cut parallel to the fabric length and width are prepared. Where possible, each specimen should contain different groups of lengthwise and widthwise yarns. The specimens should be marked to indicate the lengthwise direction. If fraying is expected in laundering, see 12.5.

8. Procedure

8.1 Tables II, III and IV summarize the alternate washing and drying conditions and settings. Additional information on the machine and laundering conditions may be found in the monograph, *Standardization of Home Laundry Test Conditions*, elsewhere in this TECHNICAL MANUAL.

8.1.1 It is recognized that special cycles or features are available on current washing machines and dryers to achieve improved performance on certain items; i.e., gentle cycles with reduced agitation

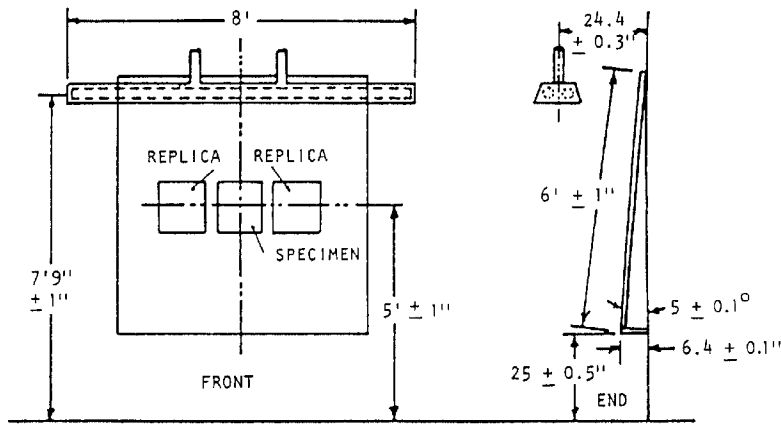

Fig. 1—Lighting equipment for viewing test specimens.

Materials list: (a) Two 8-ft Type F96 CW (Cool White) preheat Rapid Start fluorescent lamps (without baffle or glass). (b) One white enamel reflector (without baffle or glass). (c) One general type swatch mount, spring loaded. Fabricate using light sheet metal (22 ga.). (d) One 1/4 in. plywood mounting board painted to match No. 2 gray chip on AATCC Gray Scale for Staining.



Fig. 2—AATCC 3-D smoothness appearance replicas.

to protect delicately constructed items, and durable press cycles, with cool-down or cold rinses and reduced spin speeds, to minimize wrinkling. In evaluating appearance retention, however, the more severe Normal or Cotton Sturdy machine cycle is considered most appropriate. If modifications to any of the cycles (see 8.2) are used, these must be reported in the results (see Section 10).

8.2 Standard washing.

8.2.1 Hand Wash—(see 12.6). Dissolve 20.0 ± 0.1 g of 1993 AATCC Standard Reference Detergent or 30.3 g of 2003 AATCC Standard Reference Liquid Detergent in 7.57 ± 0.06 L (2.00 ± 0.02 gal) of water at $41 \pm 3^\circ\text{C}$ ($105 \pm 5^\circ\text{F}$) in a 9.5 L (10.0 qt) pail and then add the three

fabric test specimens. Wash for 2.0 ± 0.1 min with no twisting or wringing. Rinse once using 7.57 ± 0.06 L (2.00 ± 0.02 gal) of water at $41 \pm 3^\circ\text{C}$ ($105 \pm 5^\circ\text{F}$). Remove the specimens and dry by Procedure C, Drip (see 8.3.3).

8.2.2 Machine Wash—Use specified water level, the selected water temperature for the washing cycle and a rinse temperature of less than 29°C (85°F). If this rinse temperature is not attainable, record available rinse temperature.

8.2.3 Add 66 ± 0.1 g of 1993 AATCC Standard Reference Detergent or 100 ± 0.1 g of 2003 AATCC Standard Reference Liquid Detergent. In soft water areas this may be reduced to avoid excessive sudsing, but in that case the amount

should be stated in the report of test results.

8.2.4 Add test specimens and enough ballast to make a 1.8 ± 0.06 kg (4.00 ± 0.13 lb) load. Set the washer for the selected washing cycle and time (see Tables II and III). Normal or Cotton Sturdy is recommended. For very critical evaluations and in arbitration, limit the number of specimens per washer load to those from one sample.

8.2.5 For specimens to be dried by Procedures A, B or D, allow washing to proceed automatically through the final spin cycle. Remove the test specimens *immediately* after the final spin cycle, separate tangled pieces, taking care to minimize distortion, and dry by Procedure A, B or D (see Tables II and IV).

8.2.6 For specimens to be dried by Procedure C, Drip Dry, remove the specimens from the washer just before the water begins to drain for the final rinse cycle. Remove specimens soaking wet.

8.2.7 Washer creases. Specimens may be in a folded or creased conformation after removal from the washer. Such creases present after laundering should be straightened out prior to drying.

8.3 Drying.

8.3.1 (A) Tumble Dry. Place the washed load (test specimens and ballast) in the tumble dryer and set the temperature control to generate the correct exhaust temperatures as specified in Table IV. For fibers that are heat sensitive, lower temperatures consistent with producers' recommendations are required, and must be reported. Operate the dryer until the total load is dry. Remove the load immediately after the machine stops. Avoid overdrying. Static cling becomes a problem with overdrying, particularly with lightweight fabrics, because it prevents the specimens from tumbling freely.

8.3.2 (B) Line Dry. Hang each fabric specimen by two corners with the fabric length in the vertical direction. Allow specimens to hang in still air at room temperature until dry.

8.3.3 (C) Drip Dry. Hang each dripping wet fabric specimen by two corners with the fabric length in the vertical direction. Allow specimens to hang in still air at room temperature until dry.

8.3.4 (D) Screen Dry. Spread each specimen on a horizontal screen or perforated surface, removing wrinkles but not distorting or stretching the specimen. Allow the specimen to dry in still air at room temperature.

8.3.5 Dryer creases. If specimens are folded or creased after any drying cycle but the last, they should be rewet and an attempt should be made to remove the creases prior to additional washing and drying. No attempt to remove wrinkles or creases should be made after the fifth cycle of drying.

Table I—Wash Load Ballast: Finished Fabric Specification

Fiber Content	Wash Load Ballast Type 1	Wash Load Ballast Type 3
	100% Cotton	50/50 ± 3% poly/cotton
Yarns	16/1 ring spun	30/2 ring spun
Fabric Construction	52 (± 2) × 48 (± 2)	48 (± 2) × 48 (± 2)
Fabric Weight	155 ± 5 g/m ² (4.55 ± 0.15 oz/yd ²)	155 ± 5 g/m ² (4.55 ± 0.15 oz/yd ²)
Piece Size	92.0 × 92.0 ± 3 cm (36.0 × 36.0 ± 1 in.)	92.0 × 92.0 ± 3 cm (36.0 × 36.0 ± 1 in.)
Piece Weight	130 ± 10 g	130 ± 10 g

Table II—Alternative Washing and Drying Conditions (see 8.1)

Machine Cycle	Wash Temperatures	Drying Procedures
Hand, in pail	(III) 41 ± 3°C (105 ± 5°F)	(A) Tumble:
(1) Normal/Cotton Sturdy	(IV) 49 ± 3°C (120 ± 5°F)	i. Cotton Sturdy
		ii. Delicate
(2) Delicate	(V) 60 ± 3°C (140 ± 5°F)	iii. Permanent Press
(3) Permanent Press		(B) Line
		(C) Drip
		(D) Screen

Table III—Washing Machine Conditions (see 8.1)

	Normal/Cotton Sturdy	Delicate	Permanent Press
Water Level	18 ± 1 gal	18 ± 1 gal	18 ± 1 gal
Agitator Speed	179 ± 2 spm	119 ± 2 spm	179 ± 2 spm
Washing Time	12 min	8 min	10 min
Spin Speed	645 ± 15 rpm	430 ± 15 rpm	430 ± 15 rpm
Final Spin Cycle	6 min	4 min	4 min

Table IV—Dryer Conditions (see 8.1)

	Cotton Sturdy	Delicate	Durable Press
Exhaust Temperature	High 66 ± 5°C (150 ± 10°F)	Low < 60°C (140°F)	High 66 ± 5°C (150 ± 10°F)
Cool Down Time	10 min	10 min	10 min

Table V—Fabric Smoothness Grades by SA Replica Equivalents

Grade	Description
SA-5	Equivalent to the SA-5 Replica. Very smooth, pressed, finished appearance.
SA-4	Equivalent to the SA-4 Replica. Smooth, finished appearance.
SA-3.5	Equivalent to the SA-3.5 Replica. Fairly smooth but nonpressed appearance.
SA-3	Equivalent to the SA-3 Replica. Mussed, nonpressed appearance.
SA-2	Equivalent to the SA-2 Replica. Rumpled, obviously wrinkled appearance.
SA-1	Equivalent to the SA-1 Replica. Crumpled, creased and severely wrinkled appearance.

8.4 Repeat the selected washing and drying cycles four more times or to an agreed number of cycles.

8.5 Prior to evaluation, precondition and then condition test specimens as directed in ASTM D 1776, Standard Practice for Conditioning and Testing Textiles (see 12.7). Condition the test specimens for a minimum of 4 h in the standard atmosphere for textile testing [21 ± 1°C (70 ± 2°F) and 65 ± 2% RH], hanging each specimen from two corners with the fab-

ric length in vertical direction to avoid distortion.

9. Evaluation

9.1 Three trained observers should rate each test specimen independently.

9.2 The overhead fluorescent light should be the only light source for the viewing board. All other lights in the room should be turned off.

9.3 The observer is to stand directly in

front of the specimen 120 ± 3 cm (4 ft ± 1 in.) away from the board. It has been found that normal variations in the height of the observer above and below the arbitrary 1.5 m (5.0 ft) eye level have no significant effect on the grade given.

9.4 Mount the test specimen on the viewing board as illustrated in Fig. 1, with the fabric length in the vertical direction. Place the most similar three-dimensional plastic replicas on each side of the test specimen to facilitate comparative rating.

9.5 Although the 3-D Smoothness Appearance (SA) replicas were cast from woven fabrics, it is understood that these wrinkled surfaces do not duplicate all possibilities of fabric surfaces. The replicas are to be used as guides which represent various levels of fabric smoothness or freedom from wrinkles. The observer should mentally integrate degree and frequency of wrinkles in the specimen to determine a level of smoothness that can be identified with the SA replica number which most nearly represents that smoothness appearance level; see Table V.

9.6 Assign the numerical grade of the replica which most nearly matches the smoothness appearance of the test specimen, or assign a grade midway between those whole-number standards which have no half-number standards separating them (SA-1.5, SA-2.5, SA-4.5) if the appearance of the test specimen warrants it.

9.7 An SA-5 grade is equivalent to the SA-5 replica and represents the smoothest appearance, while an SA-1 replica represents very poor appearance.

9.8 If dryer creases are present on any specimens to be evaluated, take care in rating the specimens. Some dryer creases can be disregarded (commonly called "reading out"). When the grade of a dryer creased specimen differs from the other specimens by more than one grade, the test should be repeated with new specimens, taking all precautions to avoid the occurrence of dryer creases.

10. Report

10.1 Average the nine observations made on each test fabric (three grades on each of three test specimens). Report the average to the nearest tenth of a grade. This average is the unit of measure of this test method.

10.2 State washing procedure (Arabic number and Roman numeral) and drying procedure (capital letter and subscript) from Table II, detergent used (powder or liquid), as well as type of wash load ballast (Arabic number). Any deviations from stated procedures, such as use of a modified wash cycle, a reduced amount of detergent or a higher than usual load limit, should be explained completely.

10.2.1 For example, smoothness appearance grade SA-3.8 (1-IV-A(i)-3) denotes a smoothness appearance grade of 3.8 for specimens washed using a Normal (Cotton Sturdy) cycle at 49°C (120°F) with Wash load ballast type 3 and tumble dried using the Normal (Cotton Sturdy) cycle.

11. Precision and Bias

11.1 *Interlaboratory tests.* Tests were conducted in 1980 with eight laboratories evaluating four fabrics under washing and drying conditions 1-III-A and 1-IV-A of AATCC Method 124. The analysis of variance technique was judged not to be applicable to this data set because its distribution was not normal, and because of the limited and discontinuous scale of replica grades. The data were analyzed by calculating expected laboratory test results from the distribution of individual specimen grades. This analysis has been deposited for reference in the RA61 committee files.

11.2 *Observer repeatability.* From the data it was determined that single observers rated three specimens on the following frequency:

3 specimens to same replica	0.55
2 specimens to same replica and one different	0.40
3 specimens different	0.05

Only rarely did the separation in specimen grades exceed the next replica step. This is indicative of the high degree of repeatability in observer rating of smoothness appearance.

11.3 *Laboratory test result distribution (within-laboratory repeatability).* From the observed grade distribution, a distribution of laboratory test results was calculated for each replica level with half grades included. Precision over the whole SA replica range was improved.

11.4 *Precision.* From the frequency distribution of laboratory test results, a calculation was made of the critical difference, D, between two laboratory test results.

With laboratories at the same level:

Critical Difference	Confidence Level
D > 0.17	P ≥ 0.95
D ≥ 0.25	P ≥ 0.99

When two or more laboratories wish to compare test results, it is recommended that laboratory level be established between them prior to commencing test comparisons. Fabrics of known history and performance may be used for this purpose.

Differences between laboratory test results (on the same fabric, under the same washing and drying conditions) equal to or greater than a quarter replica unit are statistically significant at P ≥ 0.99. A difference of this magnitude or greater suggests a difference in laboratory levels and indicates the need for laboratory level comparisons.

11.5 *Bias.* The true value of smoothness appearance in durable press fabrics after repeated home launderings can be defined only in terms of a test method. There is no independent method for determining the true value. As an estimate of this property, this test method has no known bias.

12. Notes

12.1 Contact AATCC, P.O. Box 12215, Research Triangle Park NC 27709; tel: 919/549-8141; fax: 919/549-8933; e-mail: orders@aatcc.org, for model number(s) and source(s) of approved washer(s) and dryer(s). Any other washer or dryer which is known to give comparable results can be used. Washing machine conditions given in Table III represent the actual speeds and times available on the current specified model(s). Other washers can vary in one or more of these settings. Dryer machine conditions given in Table IV represent the actual temperatures and cool-down times available on the current specified model(s). Other dryers can vary in one or more of these settings.

12.2 Available from AATCC, P.O. Box 12215, Research Triangle Park NC 27709; tel: 919/549-8141; fax: 919/549-8933; e-mail:

orders@aatcc.org.

12.3 Ballast are available from Testfabrics Inc., P.O. Box 26, 415 Delaware St., W. Pittston PA 18643; tel: 570/603-0432; fax: 570/603-0433; e-mail: testfabric@aol.com; and Textile Innovators Corp., div. of SDL Atlas L.L.C., P.O. Box 8, 101 Forest St., Windsor NC; tel: 252/794-9703; fax: 252/794-9704; e-mail: tic@sdlatlas.com. Ballast fabrics should conform to specifications in Table I.

12.4 The use of 8-ft fixtures for viewing laundered specimens is specified in this method. It is recognized, however, that physical limitations in certain laboratories will prevent the use of 8-ft fixtures. In those situations, 4-ft lights may be used but replicas identified as SA-4, SA-3 and SA-1 should always be placed on the left side of the viewing board as the board is viewed from the front. Replicas identified as SA-5, SA-3.5 and SA-2 should always be placed on the viewing board to the right side as the board is viewed from the front.

12.5 If excessive fraying occurs in laundering, specimen edges should be pinked, slashed or stitched as appropriate. If edges of laundered specimens appear distorted, clip as necessary before evaluating.

12.6 Like other hand wash procedures, this procedure has inherent limitations; e.g., limited reproducibility of the type of action involved due to the human element.

12.7 ASTM standards are available from ASTM, 100 Barr Harbor Dr., West Conshohocken PA 19428; tel: 610/832-9500; fax: 610/832-9555.

12.8 The AATCC Technical Center conducted a study to compare the 1993 AATCC Standard Reference Detergent, AATCC Standard Reference Detergent 124 and two different types of fabrics (current and proposed) to be used as ballast, under the following test conditions:

Machine cycle: (1)—Normal/Cotton Sturdy
 Washing Temp: (V)—60 ± 3°C (140 ± 5°F)
 Drying Procedure: (A)i—Tumble dry, cotton sturdy cycle
 Fabrics tested: White Twill (100% cotton)
 Beige Twill (100% cotton)
 Grey Poplin (100% cotton)
 Blue Twill (50/50 poly/cotton)

No significant differences were found in the results using either detergent or ballast load fabrics.

Colorfastness to Perspiration and Light

Developed in 1967 by AATCC Committee RA23; jurisdiction transferred in 1996 to AATCC Committee RA50; reaffirmed 1971, 1974, 1978, 1989, 1991; revised 1982, 2004 (with title change); editorially revised and reaffirmed 1986; editorially revised 1990, 1993, 1996, 2005.

1. Purpose and Scope

1.1 The purpose of this method is to determine the effect of the combination of perspiration solution and light exposure on the colorfastness of a colored textile specimen. Therefore, only perspiration solutions will be used in this procedure.

2. Principle

2.1 A colored test specimen is immersed in a perspiration test solution for a specified period of time and immediately exposed to light in a fading apparatus for a specified period of time.

2.1.1 Fading apparatus will be the xenon-arc lamp test apparatus as described in AATCC Test Method 16, Colorfastness to Light.

3. Terminology

3.1 **colorfastness**, n.—the resistance of a material to change in any of its color characteristics, to transfer of its colorant(s) to adjacent materials or both, as a result of the exposure of the material to any environment that might be encountered during the processing, testing, storage or use of the material.

3.2 **lightfastness**, n.—the property of a material, usually an assigned number, depicting a ranked change in its color characteristics as a result of exposure of the material to sunlight or an artificial light source.

3.3 **perspiration**, n.—a saline fluid secreted by the sweat glands (in this test an artificial perspiration solution will be used).

4. Safety Precautions

NOTE: These safety precautions are for information purposes only. The precautions are ancillary to the testing procedures and are not intended to be all inclusive. It is the user's responsibility to use safe and proper techniques in handling materials in this test method. Manufacturers MUST be consulted for specific details such as material safety data sheets

and other manufacturer's recommendations. All OSHA standards and rules must also be consulted and followed.

4.1 Good laboratory practices should be followed. Wear safety glasses in all laboratory areas.

5. Apparatus, Materials and Test Solutions

5.1 Xenon-arc lamp fading apparatus (see AATCC Method 16, Option 3)

5.2 Balance with a weighing accuracy of 0.01 g.

5.3 pH meter accurate to 0.01.

5.4 Cardboard: 41 kg (91 lb) White Bristol Index (no backing of exposed area of colored test specimen) (see 12.1).

5.5 Acid perspiration solution.

5.6 Gray Scale for Color Change (see 12.1).

5.7 Blotting paper (see 12.1).

6. Preparation of Reagent

6.1 Prepare the acid perspiration solution by filling a 1 L volumetric flask half full of distilled water. Add the following chemicals and mix to be sure that all chemicals are thoroughly dissolved:

10 ± 0.01 g sodium chloride (NaCl)

1 ± 0.01 g lactic acid, USP 85%

1 ± 0.01 g disodium hydrogen phosphate, anhydrous (Na₂HPO₄) (see 12.2)

0.25 ± 0.001 g *l*-histidine monohydrochloride (C₆H₉N₃O₂·HCl·H₂O)

Fill the volumetric flask with distilled water to the 1 L mark.

6.2 Test the pH of the solution with a pH meter. If it is not 4.3 ± 0.2 discard it and prepare a new one, making sure all ingredients are weighed accurately. The use of pH test paper is not recommended for this purpose because of its lack of accuracy.

6.3 Do not use perspiration solution that is more than three days old (see 12.3).

7. Test Specimens

7.1 Cut a specimen of colored fabric 5.1 × 7.0 cm (2.0 × 2.75 in.).

8. Procedure

8.1 Weigh the specimen to ± 0.01g.

8.2 Place each test specimen (as prepared in 7.1) in a 9 cm diameter, 2 cm deep petri dish. Add freshly prepared perspiration solution to a depth of 1.5 cm in the petri dish. Soak the test specimen in the solution for 30 ± 2 min with occasional agitation and squeezing to ensure complete wetting. For fabrics hard to wet out, alternately wet the specimen and

pass through a laboratory wringer until it is completely penetrated by the solution.

8.3 Remove specimen from solution and blot each specimen to remove excess solution. Reweigh specimen to determine 100 ± 5% wet pick up.

8.4 Mount wet, unbacked specimen in exposure frame or mount specimen on water repellent backing and white card stock.

8.5 Expose specimens in fading apparatus in accordance with AATCC 16, Option 3 for 20 AFUs.

8.6 Remove the specimens.

9. Evaluation

9.1 Evaluation of color change.

9.2 The color change can be quantitatively determined by measuring the color difference between the unwashed sample and a test specimen using a suitable colorimeter or spectrophotometer with the appropriate software (see AATCC Evaluation Procedure 7, Instrumental Assessment of the Change in Color of a Test Specimen).

9.3 To evaluate the color change of the test specimens visually, follow Evaluation Procedure 1, Gray Scale for Color Change, using the Gray Scale for Color Change. For improved precision and accuracy more than one rater should rate the specimens.

10. Report

10.1 Report the color change grade.

10.2 Report the Fading apparatus used.

11. Precision and Bias

11.1 *Precision*. In 2002 a single laboratory study was performed using a single operator. This study was intended to be a temporary table of variances to give some indication of test variability. A complete interlaboratory study is to be conducted in the near future for the purposes of precision and bias. Table values do not reflect different types of material tested to this standard. *Between-Laboratory* variability is not indicated either. Special care and consideration of the variances reported must be used when examining test variability problems.

11.1.1 Samples tested consisted of four fabrics, with three replicates each. Lightfastness exposure conditions were those found in AATCC Method 16-1998, Option E. Each sample was evaluated instrumentally three times and averages were calculated. The data is found in Table I.

Table I— ΔE

	Brown #1	Brown #2	Green	Blue
Specimen 1	1.26	4.37	6.25	7.83
Specimen 2	0.95	4.89	8.18	6.42
Specimen 3	1.17	5.78	5.23	4.87
Average	1.127	5.013	6.553	6.373

Table II—Within-Laboratory Standard Errors and Sample Variance

Sample Identification	Standard Dev.	Standard Error	Sample Variance	95% Confidence
Brown #1	0.159	0.092	0.025	0.396
Brown #2	0.713	0.412	0.508	1.771
Green	1.498	0.865	2.245	3.722
Blue	1.481	0.855	2.192	3.678

*Note: Because the interlaboratory test included less than five laboratories, estimates of standard error and sample variance may be either underestimated or overestimated to a considerable extent and should be used with special caution. The values should be viewed as minimal data with regards to precision. Confidence intervals are not well established.

11.1.2 *Within-laboratory* standard errors and Sample Variance are shown in Table II. Data is on file at the AATCC Technical Center.

11.2 *Bias*. The colorfastness to natural and artificial light can be defined only in terms of a test method. There is no independent method for determining the true value. As a means of estimating this property, the method has no known bias.

12. Notes

12.1 Available from AATCC, P.O. Box 12215, Research Triangle Park NC 27709; tel: 919/549-8141; fax: 919/549-8933; e-mail: orders@aatcc.org.

12.2 Also sold as sodium phosphate, dibasic, anhydrous.

12.3 AATCC Committee RA52, Colorfastness to Perspiration, established that fungi begin to grow in the acid perspiration solution and that the pH rises after three days of storage under ambient room temperatures even when kept in a stoppered solution bottle.

Water Resistance: Hydrostatic Pressure Test

Developed in 1968 by AATCC Committee RA63; reaffirmed 1971, 1974, 1977, 1980, 1989, 2003; editorially revised 1982, 1986; editorially revised and reaffirmed 1985; revised 1995, 1998. Related to ISO 811.

1. Purpose and Scope

1.1 This test method measures the resistance of a fabric to the penetration of water under hydrostatic pressure. It is applicable to all types of fabrics, including those treated with a water resistant or water repellent finish.

1.2 Water resistance depends on the repellency of the fibers and yarns, as well as the fabric construction.

1.3 The results obtained by this method may not be the same as the results obtained by the AATCC methods for resistance to rain or water spray.

2. Principle

2.1 One surface of the test specimen is subjected to a hydrostatic pressure, increasing at a constant rate, until three points of leakage appear on its other surface. The water may be applied from above or below the test specimen.

3. Terminology

3.1 **hydrostatic pressure**, *n.*—the force distributed over an area exerted by water.

3.2 **water resistance**, *n.*—of fabric, the characteristic to resist wetting and penetration by water.

3.3 **water repellency**, *n.*—of fabric, in textiles, the characteristic of fiber, yarn, or fabric to resist wetting.

4. Safety Precautions

NOTE: These safety precautions are for information purposes only. The precautions are ancillary to the testing procedures and are not intended to be all inclusive. It is the user's responsibility to use safe and proper techniques in handling materials in this test method. Manufacturers MUST be consulted for specific details, such as material safety data sheets and other manufacturer's recommendations. All OSHA standards and rules must also be consulted and followed.

4.1 Good laboratory practices should be followed. Wear safety glasses in all laboratory areas.

4.2 Manufacturer's safety recommendations should be followed when operating laboratory testing equipment.

5. Apparatus and Materials

5.1 Hydrostatic Tester.

5.1.1 For Option 1, Hydrostatic Pressure Tester (see 11.1).

5.1.2 For Option 2, Hydrostatic Head Tester (see 11.2).

5.2 Water, distilled or de-ionized.

6. Test Specimens

6.1 A minimum of three fabric specimens should be taken diagonally across the width of the fabric to be representative of the material. Cut specimens at least 200 × 200 mm to allow proper clamping.

6.2 Handle the specimens as little as possible and avoid folding or contaminating the area to be tested.

6.3 Condition the test specimens at 21 ± 2°C (70 ± 5°F) air at 65 ± 2% RH for at least 4 h before testing.

6.4 The surface of the fabric to be exposed to water must be specified because different results may be obtained on the face and the back. Identify that surface on a corner of each specimen.

7. Procedure

7.1 Verify the water in contact with the test specimen is regulated at 21 ± 2°C (70 ± 5°F) (see 10.3).

7.2 Dry the clamping surface.

7.3 Clamp the specimen with the surface to be tested facing the water (see 11.5).

7.4 Operation.

7.4.1 Option 1—Hydrostatic Pressure Tester (see 11.1).

7.4.1.1 Turn on the motor, press the lever to raise the overflow device at the rate of 10 mm/s, and close the air vent as soon as water flows from it.

7.4.2 Option 2—Hydrostatic Head Tester (see 11.2).

7.4.2.1 Select the gradient of 60 mbar/min, press the start button (see 11.4).

7.5 Disregarding water droplets that appear within approximately 3 mm adjacent to the edge of the specimen clamping ring, record the hydrostatic pressure at the moment water droplets penetrate the fabric in three different places.

8. Calculation

8.1 Calculate the average hydrostatic pressure for each sample.

9. Report

9.1 Results for each specimen and the average for each sample.

9.2 The material and the side tested.

9.3 Water temperature and type.

9.4 Gradient (rate of increasing water pressure).

9.5 Tester option used.

9.6 Any modification to the method.

10. Precision and Bias

10.1 *Precision.* The test results are tester dependent. Precision statements for each tester are given in 10.2 and 10.3.

10.2 Suter Hydrostatic Pressure Tester (Option 1).

10.2.1 In 1993, a limited interlaboratory study was completed, which included six laboratories, two operators in each, running determinations on three specimens of two fabrics. No prior assessment was made of the relative level of the participating laboratories on performance of the test method.

10.2.2 The two fabrics were at different levels (Fabric 1 approximately 810 mm and Fabric 2 approximately 340 mm), and residual variances of the two fabrics were found to be different. Accordingly, precision is reported separately for each fabric.

10.2.3 Users of the method are advised of the limited nature of this study and advised to apply these findings with due caution.

10.2.4 Analysis of the data sets for each fabric yielded components of variance and critical differences as displayed in Tables I, II and III. Differences between two averages of (*N*) determinations, for the appropriate precision parameter, should reach or exceed the table value to be statistically significant at the 95% confidence level.

Table I—Components of Variance for Two Fabrics (Option 1 Tester)

Component	Variance Fabric 1	Variance Fabric 2
Laboratory	13.450	7.323
Operator	3.127	2.145
Specimen	30.253	5.382

Table II—Fabric 1—Critical Differences — 95% Confidence (Option 1 Tester)

Det in Avg (M)	Single Operator	Within Laboratory	Between Laboratory
1	15.25	16.02	18.97
2	10.78	11.84	15.61
3	8.80	10.08	14.31
4	7.62	9.06	13.62
5	6.82	8.04	13.19

Table III—Fabric 2—Critical Differences—95% Confidence (Option 1 Tester)

Det in Avg (N)	Single Operator	Within Laboratory	Between Laboratory
1	6.43	7.61	10.68
2	4.55	6.10	9.67
3	3.71	5.50	9.30
4	3.22	5.18	9.12
5	2.88	4.98	9.00

10.3 Textest FX3000 Hydrostatic Head Tester (Option 2).

10.3.1 In a single-laboratory study, six different laboratory technicians run determinations on three specimens of five materials.

10.3.2 The five materials were at different levels of approximately: A=103, B=33, C=37, D=12, and E=77. Data obtained in this study is recorded in millibars (SI standard). The residual variance of the five materials were found to be different, therefore, precision is reported separately for each.

10.3.3 Analysis of the data sets for each material yielded critical differences as shown in Tables IV, V, VI, VII and VIII. Differences between two averages of (N) determinations, for the appropriate precision parameter, should reach or exceed the table value to be statistically significant at the 95% confidence level.

10.3.4 Between laboratory precision has not been established for this option.

Table IV—Material A—Critical Differences—95% Confidence (Option 2 Tester)

Det in Avg (N)	Single Operator	Within Laboratory
1	72.49	72.49
2	51.26	51.26
3	41.85	41.85
4	36.25	36.25
5	32.42	32.42

Table V—Material B—Critical Differences—95% Confidence (Option 2 Tester)

Det in Avg (N)	Single Operator	Within Laboratory
1	10.08	12.85
2	7.13	9.09
3	5.82	7.42
4	5.04	6.43
5	4.51	5.75

Table VI—Material C—Critical Differences—95% Confidence (Option 2 Tester)

Det in Avg (N)	Single Operator	Within Laboratory
1	16.13	16.13
2	11.40	11.40
3	9.31	9.31
4	8.06	8.06
5	7.21	7.21

Table VII—Material D—Critical Differences—95% Confidence (Option 2 Tester)

Det in Avg (N)	Single Operator	Within Laboratory
1	2.88	3.50
2	2.04	2.47
3	1.66	2.02
4	1.44	1.75
5	1.29	1.57

Table VIII—Material E—Critical Differences—95% Confidence (Option 2 Tester)

Det in Avg (N)	Single Operator	Within Laboratory
1	15.04	16.55
2	10.63	11.70
3	8.68	9.55
4	7.52	8.27
5	6.72	7.40

Until such precision information is available, users of this method should use standard statistical techniques in making any comparison of test results for between laboratory averages.

10.4 Bias.

10.4.1 Water resistance of fabrics can only be defined in terms of a test method. There is no independent, referee method for determining the true value. This test method has no known bias.

11. Notes

11.1 Hydrostatic Pressure Tester (Suter).

11.1.1 The apparatus consists essentially of an inverted conical well equipped with a coaxial ring clamp to fasten the cloth specimen under the well bottom. The apparatus introduces water from above the specimen over an area 114 mm in diameter and at a rate of 10.0 ± 0.5 mm of hydrostatic head per second. A mirror is affixed below the specimen to enable the operator to ascertain penetration of the specimen by drops of water. A valve is provided for venting the air in the well.

11.1.2 Hydrostatic testing apparatus of the type described is available from Alfred Suter Co., P.O. Box 350, Ramsey NJ 07446-0350; tel: 201/818-0113; fax: 201/818-0654.

11.2 Hydrostatic Head Tester (Textest).

11.2.1 Uses an electronically controlled pump to apply hydrostatic pressure at 60 mbar/min (selectable) to the bottom side of the fabric. A reservoir with a circular test area of 100 ± 5 cm² (≈ 4.5 in. diam) contains distilled or deionized water which is applied to the fabric surface. The fabric specimen is secured with a coaxial clamp which is equipped with viewing lamps to aid the operator in seeing the penetration of water droplets. A digital readout displays the pressure. An RS232 data port is provided to transfer the test results for storage and statistical analysis.

11.2.2 The Textest Hydrostatic Head Tester is available from Advanced Testing Instruments Corp., 316D Business Parkway, Greer SC 29651-7119; tel: 864/989-0566; fax: 864/989-0567.

11.3 Some laboratories use water at ambient temperature. If testing is performed other than $21 \pm 2^\circ\text{C}$, so state.

11.4 1 mbar = 1.02 cm H₂O.

11.5 Lateral water leakage can be minimized by sealing the fabric with paraffin at the clamping area.

Wrinkle Recovery of Fabrics: Appearance Method

Developed in 1968 by AATCC Committee RR6; jurisdiction transferred in 1995 to AATCC Committee RA61; reaffirmed and editorially revised 1969, 1985, 1994, 2004; revised 1970, 1974; reaffirmed 1977, 1980, 1989, 1999; editorially revised 1988, 1990, 1992, 1995. Technically equivalent to ISO 9867.

1. Purpose and Scope

1.1 This test method is for determining the appearance of textile fabrics after induced wrinkling. It is applicable to fabrics made from any fiber or combination of fibers.

2. Principle

2.1 A test specimen is wrinkled under standard atmospheric conditions in a standard wrinkling device under a predetermined load for a prescribed period of time. The specimen is then reconditioned in the standard atmosphere for textile testing and evaluated for appearance by comparison with 3-dimensional reference standards.

3. Terminology

3.1 **smoothness appearance**, n.—*in fabrics*, the visual impression of planarity of a specimen quantified by comparison with a set of reference standards.

3.2 **wrinkle recovery**, n.—that property of a fabric which enables it to recover from folding deformations.

4. Safety Precautions

NOTE: These safety precautions are for information purposes only. The precautions are ancillary to the testing procedures and are not intended to be all inclusive. It is the user's responsibility to use safe and proper techniques in handling materials in this test method. Manufacturers MUST be consulted for specific details such as material safety data sheets and other manufacturer's recommendations. All OSHA standards and rules must also be consulted and followed.

4.1 Good laboratory practices should be followed. Wear safety glasses in all laboratory areas.

5. Apparatus and Materials

5.1 AATCC Wrinkle Tester (see Fig. 1, and 11.1 and 11.2).

5.2 AATCC 3-Dimensional Wrinkle Recovery Replicas (see Fig. 2 and 11.3).

5.3 Standard conditions room at $21 \pm$



Fig. 1—AATCC Wrinkle Tester.

1°C ($70 \pm 2^\circ\text{F}$) and $65 \pm 2\%$ RH.

5.4 Clothes hangers with clips.

5.5 A lighting and evaluation area in a darkened room using overhead lighting arrangement shown in Fig. 3.

6. Test Specimens

6.1 Take three test specimens from the fabric to be tested by cutting each 15×28

cm (6×11 in.) with the long dimension running in the direction of the warp of woven fabric or the wale of knit fabrics (see 11.4). Identify each specimen along one edge of the face side.

6.2 Condition specimens for a minimum of 8 h at $21 \pm 1^\circ\text{C}$ ($70 \pm 2^\circ\text{F}$) and $65 \pm 2\%$ RH.

7. Procedure

7.1 Perform all further steps at $21 \pm 1^\circ\text{C}$ ($70 \pm 2^\circ\text{F}$) and $65 \pm 2\%$ RH.

7.2 Raise top flange of wrinkle tester and hold in top position with locking pin.

7.3 Wrap one long edge (28 cm (11 in.) of the specimen around the top flange of the AATCC Wrinkle Tester with the face side of the specimen on the outside and clamp it in position using the steel spring and clamp provided. Arrange the ends of the specimen so that they are opposite the opening in the spring clamp.

7.4 Wrap the opposite long edge of the specimen around the bottom flange and clamp as described above.

7.5 Adjust the specimen by pulling on its bottom edge, so that it lies smooth without sagging between the top and the bottom flanges.

7.6 Withdraw the locking pin and lower the top flange gently with one hand until it comes to rest.

7.7 Immediately place a total of 3500

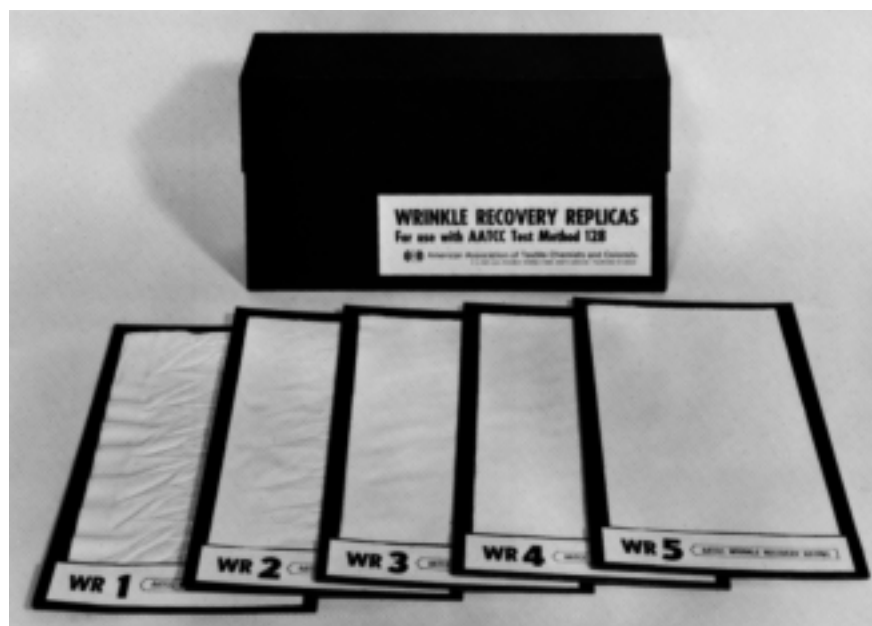

Fig. 2—AATCC Wrinkle Recovery Replicas.

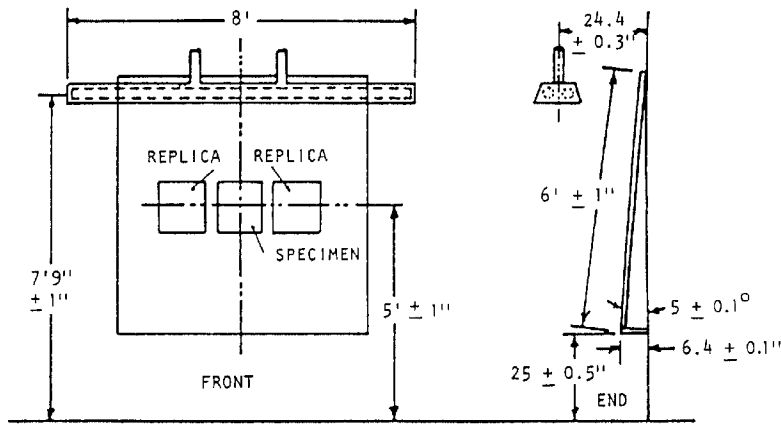

Fig. 3—Lighting equipment for viewing test specimens.

Materials list: (a) Two 8-ft Type F96 CW (Cool White) preheat Rapid Star fluorescent lamps (without baffle or glass). (b) One white enamel reflector (without baffle or glass). (c) One general type swatch mount, spring loaded. Fabricate using light sheet metal (22 ga.). (d) One ¼ in. plywood mounting board painted to match No. 2 gray chip on AATCC Gray Scale for Staining.

grams weight on the top flange and record the exact time.

7.8 After 20 min, remove the weights, remove the springs and clamps, raise the top flange and gently remove the specimen from the tester so as not to distort any induced wrinkles (see 11.5).

7.9 With a minimum of handling, place the shorter edge (15 cm) (6 in.) under the clips on the clothes hanger and allow the specimen to hang vertically in the long direction.

7.10 After 24 h in the standard atmosphere gently remove the hanger with the specimen to the evaluation site (see 11.6).

8. Evaluation

8.1 Three trained observers should rate each test specimen independently (see 11.7).

8.2 Mount the test specimen on the viewing board as illustrated in Fig. 3, with the warp in vertical direction. Place three-dimensional plastic replicas on each side of the test specimen to facilitate comparative rating.

8.2.1 The overhead fluorescent light should be the only light source for the viewing board, and all other lights in the room should be turned off.

8.2.2 It has been the experience of many observers that light reflected from the side walls near the viewing board can interfere with the rating results. It is recommended that the side walls be painted

black or that blackout curtains be mounted on either side of the viewing board to eliminate the reflective interference.

8.3 The observer is to stand directly in front of the specimen 4 ft away from the board. It has been found that normal variations in the height of the observer above and below the arbitrary 5-ft eye level have no significant effect on the rating given.

8.4 Assign the number of the replica which most nearly matches the appearance of the test specimens.

8.4.1 A No. 5 rating is equivalent to the WR-5 Replica and represents the smoothest appearance and best retention of original appearance, while a No. 1 rating is equivalent to the WR-1 Replica and represents the poorest appearance and poorest retention of original appearance (see Table I).

8.5 Similarly, the observer independently rates each of the other two test specimens. The other two observers proceed in the same manner assigning ratings independently.

Table I—Fabric Smoothness Ratings

5	—an appearance equivalent to the WR-5 Replica
4	—an appearance equivalent to the WR-4 Replica
3	—an appearance equivalent to the WR-3 Replica
2	—an appearance equivalent to the WR-2 Replica
1	—an appearance equivalent to or worse than the WR-1 Replica

9. Calculating and Reporting Results

9.1 Average the nine observations made on each test fabric (three judgments on each of three specimens).

9.2 Report the average to the nearest tenth of a rating.

10. Precision and Bias

10.1 *Precision.* Precision for this test method has not been established. Until a precision statement is generated for this test method, use standard statistical techniques in making any comparisons of test results for either *within-laboratory* or *between-laboratory* averages.

10.2 *Bias.* The wrinkle recovery of fabrics (appearance method), can be defined only in terms of a test method. There is no independent method for determining the true value. As a means of estimating this property, the method has no known bias.

11. Notes

11.1 The AATCC Wrinkle Tester is provided for introducing wrinkles in the test specimen under controlled conditions. This apparatus is based on a development of ENKA/AKU Research. The apparatus is obtainable from AATCC, P.O. Box 12215, Research Triangle Park NC 27709; tel: 919/549-8141; fax: 919/549-8933; e-mail: orders@aatcc.org.

11.2 All three weights (500, 1000 and 2000 g) provided with this tester are used in the test. The top flange assembly weighs 500 g which is 200 g heavier than that of the AKU Wrinkle Tester. The AKU Wrinkle Tester may be used for this test by adding 200 g to the top flange.

11.3 Available from AATCC, P.O. Box 12215, Research Triangle Park NC 27709; tel: 919/549-8141; fax: 919/549-8933; e-mail: orders@aatcc.org.

11.4 Cut specimens from a wrinkle-free area of the fabrics. If any wrinkles are unavoidably present in the test specimens, press each lightly with a steam iron before conditioning.

11.5 If the test has been run properly, diagonal wrinkles should run through the center portion of the specimen.

11.6 Evaluation area should also be maintained at $21 \pm 1^\circ\text{C}$ ($70 \pm 2^\circ\text{F}$) and $65 \pm 2\%$ RH.

11.7 Since previous tests have proven that specimens do change in appearance during the first few hours, it is important that accurate times be observed and that a minimum time elapses while the three observers are evaluating the samples. Because of these changing conditions, the duration of recovery before rating in this method has been standardized at 24 h.

Colorfastness to Ozone in the Atmosphere under High Humidities

Developed in 1962 by AATCC Committee RA33; editorially revised 1973, 1974, 1981, 1989, 1997; revised 1972, 1975, 1985, 2005; reaffirmed 1990, 2001; editorially revised and reaffirmed 1996. Partly equivalent to ISO 105-G03.

1. Purpose and Scope

1.1 This test method is used for determining the resistance of the color of textiles to the action of ozone in the atmosphere at elevated temperatures with relative humidities above 85%.

2. Principle

2.1 A test specimen and a swatch of control sample are simultaneously exposed to ozone in an atmosphere which is maintained at $87.5 \pm 2.5\%$ RH and a temperature of $40 \pm 1^\circ\text{C}$ ($104 \pm 2^\circ\text{F}$) until the control sample shows a color change corresponding to that of a standard of fading. The cycles are repeated until the specimen shows a definite color change or for a prescribed number of cycles.

2.2 On certain fibers, dye fading does not readily take place at humidities below 85%. Testing at high humidities is required to produce color change that predicts service fading under warm, humid conditions (see 11.1).

3. Terminology

3.1 **colorfastness**, n.—the resistance of a material to change in any of its color characteristics, to transfer of its colorant(s) to adjacent materials or both, as a result of the exposure of the material to any environment that might be encountered during the processing, testing, storage or use of the material.

4. Safety Precautions

NOTE: These safety precautions are for information purposes only. The precautions are ancillary to the testing procedures and are not intended to be all inclusive. It is the user's responsibility to use safe and proper techniques in handling materials in this test method. Manufacturers MUST be consulted for specific details such as material safety data sheets and other manufacturer's recommendations. All OSHA standards and rules must also be consulted and followed.

4.1 Good laboratory practices should be followed. Wear safety glasses in all

laboratory areas.

4.2 Ozone is a sensory irritant. The test cabinet should be ventilated to the outside atmosphere in accordance with the manufacturer's instructions.

4.3 Exposure to chemicals used in this procedure must be controlled at or below levels set by governmental authorities (e.g., Occupational Safety and Health Administration's [OSHA] permissible exposure limits [PEL] as found in 29 CFR 1910.1000 of January 1, 1989). In addition, the American Conference of Governmental Industrial Hygienists (ACGIH) Threshold Limit Values (TLVs) comprised of time weighted averages (TLV-TWA), short term exposure limits (TLV-STEL) and ceiling limits (TLV-C) are recommended as a general guide for air contaminant exposure which should be met (see 11.1).

5. Apparatus and Materials

5.1 Ozone Chamber for elevated temperatures and relative humidities above 85% (see 11.3).

5.2 Control Sample No. 129 for high humidities (see 11.4, 11.6 and 11.7).

5.3 Standard of Fading No. 129 for high humidities (see 11.5, 11.6 and 11.7).

5.4 Gray Scale for Color Change (see 11.6).

6. Test Specimens

6.1 Cut each test specimen at least 100×60 mm (4.25×2.375 in.). For subsequent color comparison, the unexposed sample should be kept in an airtight container away from light to avoid further shade change.

6.2 When a laundered or drycleaned specimen is used, base the effects of ozone exposure on comparisons with the color of the laundered or drycleaned swatch. In the preparation of specimens for testing after laundering or drycleaning, use AATCC Methods 61 and 132.

7. Procedure

7.1 Suspend test and control specimens (see 11.4 and 11.6) in the exposure chamber (see 11.3) which is maintained at $87.5 \pm 2.5\%$ RH and a temperature of $40 \pm 1^\circ\text{C}$ ($104 \pm 2^\circ\text{F}$). Ozone concentrations must range from 10-35 pphm which should produce one cycle of fading in 3-28 h of test.

7.2 Examine the control specimen periodically until the resulting color corre-

sponds to that of the standard of fading (see 11.5 and 11.6) when compared in daylight ranging from average to slightly bluish north sky light, or equivalent artificial light. This constitutes one cycle (see 11.8).

7.3 Remove those specimens which exhibit a color change at the end of one cycle. One cycle will generally produce a measurable color change in specimens which are ozone sensitive.

7.4 Suspend a fresh control specimen and continue exposure of any remaining specimens for a second cycle.

7.5 Run additional similar cycles as necessary.

8. Evaluation

8.1 At the end of each cycle immediately compare those specimens which are removed from the exposure chamber with the preserved original from which they were drawn.

8.2 Rate the effect on color of test specimens after any specified number of cycles by reference to the Gray Scale for Color Change, and report the number of cycles run as follows (see 11.10):

Grade 5—negligible or no color as shown in Gray Scale Step 5.

Grade 4.5—change in color equivalent to Gray Scale Step 4-5.

Grade 4—change in color equivalent to Gray Scale Step 4.

Grade 3.5—change in color equivalent to Gray Scale Step 3-4.

Grade 3—change in color equivalent to Gray Scale Step 3.

Grade 2.5—change in color equivalent to Gray Scale Step 2-3.

Grade 2—change in color equivalent to Gray Scale Step 2.

Grade 1.5—change in color equivalent to Gray Scale Step 1-2.

Grade 1—change in color equivalent to Gray Scale Step 1.

9. Report

9.1 Report the numerical rating for the change in color of the test specimen, the number of cycles run and the temperature and relative humidity at which the test was performed.

10. Precision and Bias

10.1 Precision for this test method has not been established. Until a precision statement is generated for this test method, use standard statistical tech-

niques in making any comparisons of test results for either *within-laboratory* or *between-laboratory* averages.

11. Notes

11.1 Available from Publications Office, ACGIH, Kemper Woods Center, 1330 Kemper Meadow Dr., Cincinnati OH 45240; tel: 513/742-2020.

11.2 At high humidities, the fading of dyes by ozone on small fibers (such as nylon) is altered greatly by relatively small variations in relative humidity. Therefore, to achieve reproducibility and good interlaboratory correlation in test results, temperature and relative humidity must be closely controlled.

11.3 The ozone exposure chamber for elevated temperatures and relative humidities above 85% can be of variable construction as long as it meets the conditions of $87.5 \pm 2.5\%$ RH, $40 \pm 1^\circ\text{C}$ ($104 \pm 2^\circ\text{F}$) temperature and contains an ozone concentration in the range of 10-35 pphm.

11.3.1 Blueprints of a suitable apparatus are available from AATCC, P.O. Box 12215, Research Triangle Park NC 27709; tel: 919/549-8141; fax: 919/549-8933; e-mail: orders@aatcc.org.

11.3.2 For information regarding the measurement of ozone concentration, see the following references:

Schulze, Fernand, "Versatile Combination

Ozone and Sulfur Dioxide Analyzer," *Analytical Chemistry*, Vol. 38, 748-752, May 1966.

"Selected Methods of the Measurement of Air Pollutants," Public Health Service Publication No. 999-AP-11, May 1965. Office of Technical Information and Publication (OTIP), Springfield VA, PB167-677.

11.3.3 Apparatus for measuring ozone concentration is commercially available from several manufacturers including the following: Beckman Instruments Inc., 2500 Harbor Blvd., Fullerton CA 92634; and Mast Development, 2212 East 12th St., Davenport IA 52803.

11.4 The control sample for tests made at elevated temperatures and relative humidities above 85% is a tertiary shade, avocado, prepared by dyeing a Y-cross-section nylon 6 unautoclaved knitted sleeve with the following formula: 0.15% C.I. Disperse Red 4, 0.63% C.I. Disperse Yellow 3 and 0.25% C.I. Disperse Blue 3 based on the weight of the fabric.

11.5 The standard of fading for tests made at elevated temperatures and relative humidities above 85% is a dyeing of the same Y-cross-section nylon 6 unautoclaved knitted sleeve with the following formula: 0.557% C.I. Acid Yellow 79, 0.081% C.I. Acid Red 361 and 0.102% C.I. Acid Blue 277.

11.6 Available from AATCC, P.O. Box 12215, Research Triangle Park NC 27709; tel: 919/549-8141; fax: 919/549-8933; e-mail: orders@aatcc.org.

11.7 **Caution:** Both the control sample and the standard of fading must be kept in airtight containers to prevent color change encountered in normal atmospheres. The control fabric is also sensitive to other atmospheric contaminants such as oxides of nitrogen. Its fading rate will vary considerably at different humidities and temperatures and its use in natural or end-use testing as a measure of exposure to ozone is not recommended. The color change produced on the control will reflect the combined effects of the atmospheric contaminants present, and temperature, humidity variations and not just the effects of exposure to ozone.

11.8 An alternative method of determining one cycle of fade is to terminate the exposure cycle when the Control Sleeve 129 exhibits a color change of 28.5 ± 1.2 CIELAB units for Lot No. 10 (see 11.9).

11.9 Make colorimetric or spectrophotometric measurement of Control Sleeve 129 with the specular component included. Calculate colorimetric data using the CIE 1964 10° observer data for Illuminant D₆₅. The color difference shall be expressed in CIELAB units.

11.10 An automated electronic grading system may be used as long as the system has been demonstrated to provide results that are equal to and provide equal or better repeatability and reproducibility than an experienced grader performing visual evaluation.

Soil Release: Oily Stain Release Method

Developed in 1969 by AATCC Committee RA56; reaffirmed 1970, 1974, 1977; editorially revised 1978, 1983, 1986, 1997, 2004, 2005; revised 1981, 1990, 1995; editorially revised and reaffirmed 2000.

1. Purpose and Scope

1.1 This test method is designed to measure the ability of fabrics to release oily stains during home laundering.

1.2 This test method is primarily for use by fabric finishers to evaluate the likely performance of soil release finishes in actual use (see 12.1). If this test method is used as part of a contract between buyer and seller, or in any case where comparisons between laboratories are being made, the parties should agree to use the same ballast and detergent. In referee situations, or where standard specifications are involved, 1993 AATCC Standard Reference Detergent should be used (see 12.7).

1.3 The use of this test on garments is not precluded.

2. Principle

2.1 A stain is applied to a test specimen. An amount of the staining substance is forced into the fabric by using a specified weight. The stained fabric is then laundered in a prescribed manner and the residual stain rated on a scale from 5 to 1 by comparison with a stain release replica showing a graduated series of stains.

3. Terminology

3.1 **soil**, n.—dirt, oil or other substances not normally intended to be present on a substrate such as a textile material.

3.2 **soil release**, n.—the degree to which a soiled substrate approaches its original, unsoiled appearance as a result of a care procedure.

3.3 **stain**, n.—a local deposit of soil or discoloration on a substrate that exhibits some degree of resistance to removal, as by laundering or drycleaning.

4. Safety Precautions

NOTE: These safety precautions are for information purposes only. The precautions are ancillary to the testing procedures and are not intended to be all inclusive. It is the user's responsibility to use

safe and proper techniques in handling materials in this test method. Manufacturers MUST be consulted for specific details such as material safety data sheets and other manufacturer's recommendations. All OSHA standards and rules must also be consulted and followed.

4.1 Good laboratory practices should be followed. Wear safety glasses in all laboratory areas.

4.2 The 1993 AATCC Standard Reference Detergent may cause irritation. Care should be taken to prevent exposure to skin and eyes.

4.3 Manufacturer's safety recommendations should be followed when operating laboratory testing equipment.

5. Apparatus and Materials (see 12.1)

5.1 AATCC White Textile Blotting Paper (see 12.2).

5.2 Corn oil (see 11.1 and 12.3).

5.3 Glassine paper or equivalent (see 12.4).

5.4 Timer.

5.5 Weight, cylinder 6.4 cm (2.5 in.) diam., 2.268 ± 0.045 kg (5.0 ± 0.1 lb) (stainless steel is preferable).

5.6 Amber bottle with medicine dropper (see 12.5).

5.7 Washer, automatic (see 12.6).

5.8 Dryer, automatic (see 12.6).

5.9 Granular commercial detergent, home wash or 1993 AATCC Standard Reference Detergent (see 1.2 and 12.7).

5.10 Ballast of 92 × 92 ± 3 cm (36 × 36 ± 1 in.) hemmed pieces of bleached cotton sheeting (Ballast wash load Type 1) or 50/50 polyester/cotton bleached mercerized plain weave (Ballast wash load Type 3) (see 12.8).

5.11 Lighting and evaluation area (see 12.9).

5.12 Table with non-glare black top 61 × 92 cm (24 × 36 in.); 89 ± 3 cm (35 ± 1 in.) high.

5.13 Stain Release Replica or 3M Stain Release Rating Scale (see 12.10).

5.14 Thermometer (see 12.11).

5.15 Balance or scale appropriate for the weights required.

6. Test Specimens

6.1 Use two test specimens 38 × 38 ± 1 cm (15.0 × 15.0 ± 0.4 in.) for each determination. Condition the test specimens for a minimum of 4 h at 21 ± 1°C (70 ± 2°F) and 65 ± 2% RH prior to application of stains.

7. Staining Procedure

7.1 Place the unstained specimen flat on a single thickness of AATCC White Textile Blotting Paper on a smooth, horizontal surface.

7.2 Using the medicine dropper, place 5 drops (approx. 0.2 mL) of corn oil (see 12.3) in the approximate center of the test specimen.

7.3 Place a 7.6 × 7.6 cm (3.0 × 3.0 in.) square of glassine paper over the stained area.

7.4 Place the weight (see 5.5) on the glassine paper directly over the stained area.

7.5 Allow weight to sit undisturbed for 60 ± 5 s. Then remove the weight and discard the glassine sheet.

7.6 Do not allow stained test specimens to contact each other in a manner which would transfer stains. Wash within 20 ± 5 min after staining.

8. Washing Procedure

8.1 Fill washer to high water level with water at one of the temperatures from Table I. Check with the thermometer.

8.2 Add 100 ± 1 g of detergent to the washer.

8.3 Start the water agitating, place ballast and then test specimens in the washer making a total load of 1.80 ± 0.07 kg (4.00 ± 0.15 lb). The maximum number of test specimens per washer load shall be 30 with one stain per specimen.

8.4 Set the dial on the washer for a Normal wash to run for 12 min measured time and allow cycle to run to completion. (This gives normal agitation in both the wash and the rinse.)

8.5 At the end of the final spin cycle, place the entire load, test specimens and ballast, into the dryer.

8.6 Dry at *Normal (Cotton Sturdy)* setting at a time setting of 45 min or until dry. On some dryers a 5 min cooldown automatically follows the drying on the *Normal (Cotton Sturdy)* setting. For dryers without this feature dry at High setting for 45 ± 5 min and change setting to Air and run for 5 min. Maximum dryer stack temperature at the cabinet exit

Table I—Washing Temperature Selection

Washing Procedure	Temperature
II	27 ± 3°C (80 ± 5°F)
III	41 ± 3°C (105 ± 5°F)
IV	49 ± 3°C (120 ± 5°F)
V	60 ± 3°C (140 ± 5°F)

should be $65 \pm 6^\circ\text{C}$ ($150 \pm 10^\circ\text{F}$) with the heating element on.

8.7 Remove specimens from dryer immediately on completion of the cycle and lay flat to prevent formation of wrinkles or creases which can affect the stain release rating. Rate residual stains within 4 h after drying.

9. Evaluation

9.1 Mount the stain release replica on the mounting board, with the center of the standard 114 ± 3 cm (45 ± 1 in.) from the floor.

9.2 Place the test specimen flat with face up in the center of the non-glare black topped table with one edge of the table touching the mounting board. The fabric shall be rotated to be viewed from the direction which produces the lowest rating.

9.3 Viewing distance shall be 76 ± 3 cm (30 ± 1 in.) from the back mounting board, with the eye at 157 ± 15 cm (62 ± 6 in.) from the floor. The rater should stand directly in front of the specimen. Varying the viewing angle either horizontally or vertically can affect grades obtained on some fabrics.

9.4 Each rater shall independently compare the residual stain on the test specimen with the stains on the stain release replica and rate each test specimen to the nearest 0.5 grade according to Table II.

10. Report

10.1 Calculate the average of 4 grades for each fabric, (2 judgments on each of 2 specimens), to nearest 0.1. This is the unit of measure for this test method.

10.2 Report whether the Stain Release Replica or the 3M Stain Release Rating Scale was used.

10.3 Report the washing procedure used by appropriate Roman numeral from Table I.

10.4 If stain(s) other than the corn oil are used, identify each stain and report the stain release grade obtained for each stain separately.

10.5 Report water hardness of the washing procedure in terms of parts per million (ppm).

10.6 Report the type ballast material used.

10.7 Report the detergent used and the phosphorus content of the detergent as indicated on the container (see 12.7).

10.8 Report manufacturer and model number of the washer and dryer.

11. Precision and Bias

11.1 *Summary*: An interlaboratory test was carried out in the summer of 1987 to establish the precision of this test method. One operator at each of 5 laboratories tested 2 specimens of each of 5 fabrics each day for 3 days using 1 washer and 1 dryer. Tide (see 12.7) detergent containing 9.8% phosphorus was used because it was the most widely used detergent available. The reference vegetable oil used was Mazola brand corn oil (see 12.3) because it was widely available and consistent in color and quality. Two raters independently evaluated the specimens using the Stain Release Replica and the 3M Stain Release Rating Scale. The unit of measure was the average of the 2 grades for the 2 specimens tested each day. The fabrics were limited to polyester and polyester/cotton materials, most having soil release finishes.

11.2 The components of variance as standard deviations of stain release grades were calculated to be as follows:

	Stain Release Replica	3M Stain Release Rating Scale
Single operator/washer	0.30	0.44
Between laboratories	0.23	0.37

11.3 *Critical Differences*. For the components of variance in 11.2, two averages of observed values should be considered significantly different at the 95% probability level if the difference equals or exceeds the critical differences shown in Table III.

11.4 *Bias*. The true value of the oily stain release grade can only be defined in terms of this test method. Within this limitation, this test method has no known bias.

11.5 A subsequent study by the AATCC Laboratory indicated a statistical difference at the 95% probability level between the new 1993 AATCC Standard Reference Detergent and the AATCC

Standard Reference Detergent 124. An interlaboratory study will be conducted to confirm this difference and establish the precision of this test method with the new ballast Type 3 in the comparative study (see 12.1).

12. Notes

12.1 The 1995 revision of this method reflects the change in formulation of the reference detergent and provides an additional choice of ballast in order to more nearly evaluate the performance of soil release finishes under conditions of actual use. Corn oil has been retained as the reference oily stain. Preliminary comparative studies with the new reference detergent and new ballast Type 3 were conducted by the AATCC Laboratory. No statistical difference at the 95% probability level was observed for the new ballast Type 3. However, these early results indicate a statistical difference between the new 1993 AATCC Standard Reference Detergent and the previous AATCC Standard Reference Detergent 124, the new detergent tending to be less efficient toward oily stain release removal. An interlaboratory study will be conducted in 1995-1996 to confirm this difference and determine the precision of this test method with the new reference detergent.

12.2 AATCC White Textile Blotting Paper is available from AATCC, P.O. Box 12215, Research Triangle Park NC 27709; tel: 919/549-8141; fax: 919/549-8933; e-mail: orders@aatcc.org.

12.3 Mazola, a trademark of Best Foods, CPC International Inc., General Offices, Englewood Cliffs NJ 07632, is a pure corn oil and is widely available. Each bottle has an expiration date printed on the label. It should not be used after that date.

12.4 Rhinelander "Blu-White" window envelop glassine — 61×91 cm — 25#/500. Packages of glassine paper containing a roll 46 m long by 30 cm wide (150×1 ft) are available from AATCC, P.O. Box 12215, Research Triangle Park NC 27709; tel: 919/549-8141; fax: 919/549-8933; e-mail: orders@aatcc.org.

12.5 The amber bottle is specified to protect the corn oil from degradation.

12.6 Contact AATCC for model number(s) and source(s) of approved washer(s) and dryer(s). Any other washer or dryer which is known to give comparable results can be used.

12.7 Use a detergent available in the local market. This method was developed using Tide detergent, 9.8%P, because it was the most widely used of the detergents available. Tide

Table III—Critical Differences, Grades, for the Conditions Noted^a

(Observation = Unit of Measure = Average of 2 grades for 2 specimens)

Table II—Stain Release Grades

Grade 5 — Stain equivalent to Standard Stain 5
 Grade 4 — Stain equivalent to Standard Stain 4
 Grade 3 — Stain equivalent to Standard Stain 3
 Grade 2 — Stain equivalent to Standard Stain 2
 Grade 1 — Stain equivalent to Standard Stain 1

Grade 5 represents the best stain removal and Grade 1 the poorest stain removal.

No. of Observations	Single Operator/Washer		Between Laboratories	
	Stain Release Replica	3M Stain Release Rating Scale	Stain Release Replica	3M Stain Release Rating Scale
1	0.82	1.20	1.04	1.58
2	0.58	0.85	0.86	1.33
3	0.47	0.70	0.79	1.23

^a The critical differences were calculated using $t = 1.950$, which is based on infinite degrees of freedom.

is a trademark of Procter & Gamble, Cincinnati OH 45202. In referee situations, or in cases where standard specifications are involved, 1993 AATCC Standard Reference Detergent should be used (available from AATCC, P.O. Box 12215, Research Triangle Park NC 27709; tel: 919/549-8141; fax: 919/549-8933; e-mail: orders@aatcc.org). Institutional detergents are not to be used in this procedure. Refer to the *Standardization of Home Laundry Conditions* monograph elsewhere in this MANUAL.

12.8 Ballast is available from Testfabrics Inc., P.O. Box 26, 415 Delaware St., W. Pittston PA 18643; tel: 570/603-0432; fax: 570/603-0433; e-mail: testfabric@aol.com; and Textile Innovators Corp., div. of SDL Atlas L.L.C., P.O. Box 8, 101 Forest St., Windsor NC; tel: 252/794-9703; fax: 252/794-9704; e-mail: tic@sdlatlas.com. There is a possibility

of finish and/or oil redeposition on the ballast leading to subsequent transfer to test specimens. Fresh ballast should be used whenever it is deemed that buildup has occurred to the point where stain release results would be affected significantly or in cases where results are critical in adopting new finishes. The ballast should be replaced when it becomes obviously worn or frayed.

12.9 Use the lighting and viewing areas as described in AATCC Method 124, Appearance of Fabrics after Repeated Home Launderings, and the lighting equipment for viewing test specimens with overhead lighting. Place the black topped table with the 89 cm (35 in.) edge against the mounting board.

12.10 The Stain Release Replica developed by Milliken & Co. is available from AATCC, P.O. Box 12215, Research Triangle Park NC 27709; tel: 919/549-8141; fax: 919/549-8933;

e-mail: orders@aatcc.org.

12.10.1 A scale found useful by some is the 3M Stain Release Rating Scale. It may be used if agreed upon by the parties involved and is available from 3M Co., Bldg. 53-1S-02, 367 Grove St., St. Paul MN 55144; tel: 651/778-5879; fax: 651/778-5397.

12.10.2 The stain release replica should be replaced every 12 months and stored in the dark to prevent fading.

12.11 Use a dial scale thermometer reading from 0-180°F in 2°F divisions. A suitable one is available from Fisher Scientific Co., 2775 Pacific Dr., Norcross GA 30091, 1988 Catalog No. 15-076B. A similar thermometer reading from 0-100°C in 1°C divisions is available from the same source as Catalog No. 15-077C. Suitable thermometers are also available from a number of other sources.

Colorfastness to Pleating: Steam Pleating

Developed in 1969 by AATCC Committee RR53; reaffirmed 1970, 1971, 1974, 1977, 1980, 1985, 1990, 2005; editorially revised 1981, 1988, 2004; editorially revised and reaffirmed 1995, 2000. Technically equivalent to ISO 105-P02.

1. Purpose and Scope

1.1 This test method is intended for assessing the resistance of the color of textiles of all kinds and in all forms to the action of steam pleating processes. The materials are not pleated during the test, and it is emphasized that the test is not intended for assessing the quality of the pleating process (see 11.6).

1.2 Three tests differing in severity are provided; one or more of them may be used depending on the requirements.

1.3 The severe test is intended primarily for wholly manufactured textiles such as those made from polyamide and polyester fibers. It should not be used for textiles containing wool.

2. Principle

2.1 A specimen of the textile in contact with specified undyed cloths is steamed under specific conditions of pressure and time and then dried. The change in color of the specimen and the staining of the undyed cloths are assessed with standard gray scales.

3. Terminology

3.1 **colorfastness**, n.—the resistance of a material to change in any of its color characteristics, to transfer of its colorant(s) to adjacent materials or both, as a result of the exposure of the material to any environment that might be encountered during the processing, testing, storage or use of the material.

3.2 **pleating**, n.—the process of making one or more desirable folds in a cloth by doubling the material over on itself.

4. Safety Precautions

NOTE: These safety statements are for information purposes only. The precautions are ancillary to the testing procedures and are not intended to be all inclusive. It is the user's responsibility to use safe and proper techniques in handling materials in this test method. Manufacturers MUST be consulted for specific details such as material safety data sheets and other manufacturer's recommenda-

tions. All OSHA standards and rules must be consulted and followed.

4.1 Good laboratory practices should be followed. Wear safety glasses in all laboratory areas.

4.2 Manufacturer's safety recommendations should be followed when operating laboratory testing equipment.

5. Apparatus and Materials

5.1 Specimen holder (see Fig. 1 and 11.1).

5.2 Jacketed steamer (see 11.2) or pressure cooker (see 11.3).

5.3 Two undyed scoured cloths, each measuring 5×4 cm (2×1.6 in.), made of the same kind of fiber as that of the textile to be tested or as otherwise specified. In the case of blends, two different undyed scoured cloths are required, corresponding to the two predominating fibers (see 11.4).

5.4 Gray Scales for evaluating change in color and staining (see 11.5).

6. Test Specimens

6.1 If the textile to be tested is fabric, place a specimen of it 5.0×4.0 cm (2.0×1.6 in.) between two pieces of undyed cloth (see 5.3) and sew along one side to form a composite specimen.

6.2 If the textile to be tested is yarn, knit it into fabric and treat it as in 6.1, or form a layer of parallel lengths of it between the two pieces of undyed cloth (see

5.3), the amount of yarn taken being approximately equal to half the combined mass of the undyed cloths. Sew along one side to hold the yarn in place and to form a composite specimen.

6.3 If the textile to be tested is loose fiber, comb and compress an amount approximately equal to half cloths (see 5.3) into a sheet 5.0×4.0 cm (2.0×1.6 in.). Place the sheet between the two undyed cloths, and sew along all four sides to form a composite specimen.

7. Procedure

7.1 Mount the composite specimen in the holder between the two undyed cloths (see 5.3) as shown in Fig. 1.

7.2 Place the holder containing the composite specimen in a jacketed steamer (see 11.2) or a pressure cooker (see 11.3).

7.3 Steam under one of the sets of conditions listed in Table I.

7.4 When steaming is complete, release the pressure over a period not exceeding 2 min.

7.5 Open out the composite specimen and dry in air at a temperature not exceeding 60°C (140°F) with the two or three parts in contact only at one line of stitching. Condition at $20 \pm 2^\circ\text{C}$ ($68 \pm 3^\circ\text{F}$) and $65 \pm 2\%$ RH for 4 h.

7.6 Specimens which liberate formaldehyde under steam pleating conditions should be tested separately.

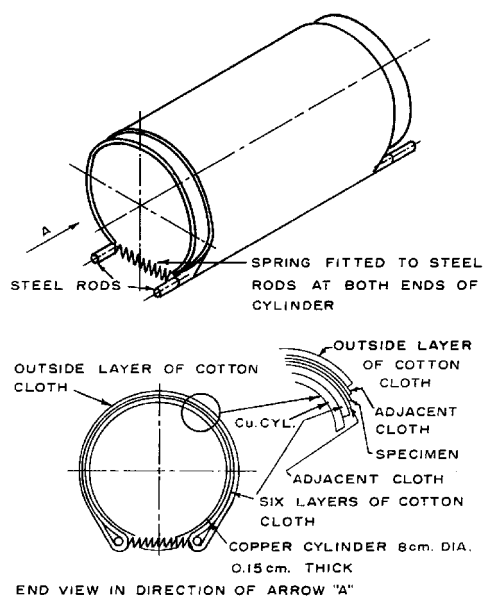

Fig. 1—Specimen holder.

Table I—Steaming Conditions

Test	Duration	Pressure (Gauge)	Temperature
I. Mild	5 min	0.35 kg/cm ² (5 lb/in. ²)	108°C (226°F)
II. Intermediate	10 min	0.7 kg/cm ² (10 lb/in. ²)	115°C (239°F)
III. Severe	20 min	1.76 kg/cm ² (25 lb/in. ²)	130°C (266°F)

8. Evaluation

8.1 Rate the change in color of the test specimen with the Gray Scale for Color Change after conditioning (see 7.5).

8.2 Rate the staining of the undyed cloth(s) with the Gray Scale for Staining.

9. Report

9.1 Type of test (I, II, or III) (see 7.3).

9.2 Numerical grade of the change in color of the test specimen noting composition of the test specimen.

9.3 Numerical grade of the staining of the undyed cloth(s), noting the composition of the undyed cloth(s). If the two cloths are identical and show different degrees of staining, only the heavier should be reported.

10. Precision and Bias

10.1 *Precision.* Precision for this test method has not been established. Until a precision statement is generated for this test method, use standard statistical techniques in making any comparisons of test results for either *within-laboratory* or *between-laboratory* averages.

10.2 *Bias.* Colorfastness to steam pleating can be defined only in terms of a test method. There is no independent method for determining the true value. As a means of estimating this property, the method has no known bias.

11. Notes

11.1 The specimen holder consists of a copper tube 8 cm (3 in.) in external diameter. The thickness of the copper is 0.15 cm (0.06 in.). The copper tube is wrapped with six layers of bleached cotton cloth weighing 125g/m² (3.7 oz/yd²). The outside layer is made from bleached cotton cloth weighing 186g/m² (5.5 oz/yd²). The edge of the outside layer is folded back and sewn so as to provide a place for

insertion of the rods. The rods at each end are made from 0.6 cm (0.25 in.) diameter soft steel. The strength of the springs is not critical, but it should be sufficient to hold the layer tightly against the tube. The springs are fastened to one of the steel rods and should hook easily onto the other steel rod (see Fig. 1). A 15.2 cm (6 in.) long specimen holder is available from SDL Atlas L.L.C., 1813A Associate Lane, Charlotte NC 28217; tel: 704/329-0911; fax: 704/329-0914; e-mail: info@sdlatlas.com.

11.2 A jacketed steamer may be used, provided that the pressure can be accurately determined and that no water splashes on the specimen during the test.

11.3 A domestic pressure cooker may be used as an alternative to a jacketed steamer. Its dimensions should be sufficiently large to avoid water splashing onto the specimen during the test; it is suggested that the minimum size should be 23 cm (9 in.) in diameter and 26 cm (10 in.) high. It should be fitted with an

accurate pressure gauge. If a domestic pressure cooker is used, the specimen holder should be loosely wrapped in one layer of polyester film, which projects 1 cm (0.5 in.) over each end of the tube and is not closed at the ends. The specimen holder (see Fig. 2) should then be placed in a rectangular metal container containing ten 0.1 cm (0.06 in.) holes equally spaced along the center of the bottom. The container should be sufficiently deep to reach to 1 cm (0.5 in.) from the top of the specimen holder. The bottom of the container should be slightly concave to ensure that condensed water rapidly drains away. The container is then placed on a stand which holds it 5 cm (2 in.) from the surface of the water. The quantity of water in the cooker is not critical, but water to a depth of 3 cm (1 in.) is suggested. Expel air from the pressure cooker for 2 min before raising the pressure.

11.4 If wool is used as one of the adjacent cloths (see 5.3) it may have an adverse effect on the dye in the specimen, particularly under alkaline conditions.

11.5 Available from AATCC, P.O. Box 12215, Research Triangle Park NC 27709; tel: 919/549-8141; fax: 919/549-8933; e-mail: orders@aatcc.org.

11.6 It should be noted that the papers used in commercial pleating occasionally contain reducing agents which with certain coloring matters can produce a much greater change in color than occurs under the test conditions.

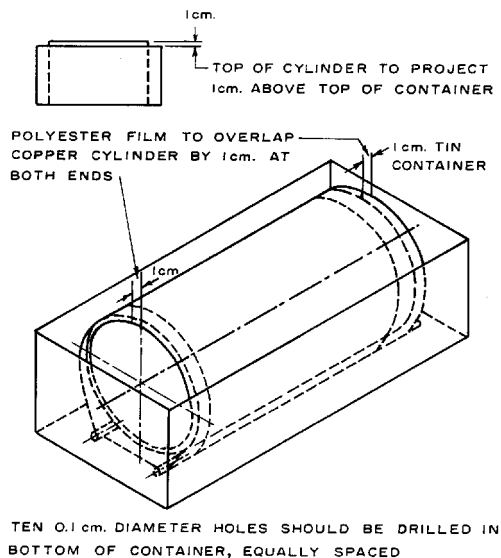

Fig. 2—Specimen holder in the container.

Colorfastness to Drycleaning

Developed in 1969 by AATCC Committee RA43. Supersedes AATCC 85-1968; re-affirmed 1973, 1976, 1979, 1989, 1998, 2003; editorially revised 1981, 1986, 1990, 1995, 2001, 2002; editorially revised and reaffirmed 1985; revised 1993, 2004. Technically equivalent to ISO 105-D01.

1. Purpose and Scope

1.1 This test method is intended for determining the colorfastness of textiles to all kinds to drycleaning.

1.2 The test method is neither suitable for the evaluation of the durability of textile finishes, nor is it intended for use in evaluating the resistance of colors to spot and stain removal procedures used by the drycleaner (see 11.1).

1.3 This test method gives an indication of results to be obtained from three commercial drycleanings.

2. Principle

2.1 A specimen of the textile in contact with cotton fabric, multifiber swatch and noncorrodible steel discs is agitated in perchloroethylene (see 11.2) and then dried in air. Any change in color of the specimen is then assessed with the standard Gray Scale for Color Change.

2.2 Any staining is assessed by using the Gray Scale for Staining or the Chromatic Transference Scale.

3. Terminology

3.1 **colorfastness**, n.—the resistance of a material to change in any of its color characteristics, to transfer of its colorant(s) to adjacent materials or both, as a result of the exposure of the material to any environment that might be encountered during the processing, testing, storage or use of the material.

3.2 **drycleaning**, n.—the cleaning of fabrics with organic solvents such as petroleum solvent, perchloroethylene or fluorocarbon.

NOTE: The process also includes adding detergent and moisture to the solvent, up to 75% RH, and hot tumble drying to 71°C (160°F).

4. Safety Precautions

NOTE: These safety precautions are for information purposes only. The precautions are ancillary to the testing procedures and are not intended to be all inclusive. It is the user's responsibility to use safe and proper techniques in handling

materials in this test method. Manufacturers MUST be consulted for specific details such as material safety data sheets and other manufacturer's recommendations. All OSHA standards and rules must be consulted and followed.

4.1 Good laboratory practices should be followed. Wear safety glasses in all laboratory areas.

4.2 All chemicals should be handled with care.

4.3 Perchloroethylene is toxic by inhalation, by repeated contact with the skin and by ingestion; it should be used only in a well vented atmosphere. Toxicology studies with laboratory animals have shown evidence of cancer in rats and mice exposed to perchloroethylene vapors at 100-400 ppm concentrations for prolonged times. Fabric saturated with this solvent should be dried in an adequately ventilated hood. Use chemical goggles or face shield, impervious gloves and an impervious apron when handling perchloroethylene.

4.4 An eyewash/safety shower should be located nearby and an organic vapor respirator should be readily available for emergency use.

4.5 Exposure to chemicals used in this procedure must be controlled at or below levels set by governmental authorities (e.g., Occupational Safety and Health Administration's [OSHA] permissible exposure limits [PEL] as found in 29 CFR 1910.1000 of January 1, 1989). In addition, the American Conference of Governmental Industrial Hygienists (ACGIH) Threshold Limit Values (TLVs) comprised of time weighted averages (TLV-TWA), short term exposure limits (TLV-STEL) and ceiling limits (TLV-C) are recommended as a general guide for air contaminant exposure which should be met (see 11.3).

4.6 Manufacturer's safety recommendations should be followed when operating laboratory testing equipment.

4.7 Any perchloroethylene residue must be sent to a permitted waste management facility. Any disposal must be in compliance with federal, state or local regulations.

5. Apparatus and Materials

5.1 Launder-Ometer (see 11.4).

5.2 Standard stainless-steel containers, 7.5 cm diam × 12.5 cm (3 in. diam × 5 in.), of approximately 500 mL (1 pt) capacity, which can be closed using solvent-resistant gaskets (see 11.4).

5.3 Noncorrodible steel discs, 30.0 ± 2.0 mm (1.18 ± 0.08 in.) diam × 3.0 ± 0.5 mm (0.12 ± 0.02 in.) smooth and free from rough edges, weight 20.0 ± 2.0 g (0.7 ± 0.07 oz) (see 11.4).

5.4 Undyed cotton twill cloth weighing 270 ± 70 g/m² (8 ± 2 oz/yd²), free from finishes and cut into swatches 12.0 × 12.0 cm (4.75 × 4.75 in.) (see 11.5).

5.5 Multifiber test fabrics No. 1 and FB (8 mm [0.33 in.] bands) contains bands of acetate, cotton, nylon, silk, viscose rayon and wool. Multifiber test fabrics No. 10, and FA (8 mm [0.33 in.] bands) and No. 10A and FAA (15 mm [0.6 in.] bands) contain bands of acetate, cotton, nylon, polyester, acrylic and wool (see 11.6).

5.6 Perchloroethylene, commercial drycleaning grade.

5.7 Gray Scale for Color Change (see 11.7).

5.8 Gray Scale for Staining or AATCC Chromatic Transference Scale (see 11.7).

5.9 Colorimeter or spectrophotometer.

5.10 Crockmeter Test Cloth (see 11.5).

5.11 Detergent, Perk-Sheen (see 11.8).

6. Specimens

6.1 If the textile to be tested is fabric, use three specimens, each 10 × 5 cm (4 × 2 in.) with the longer dimension parallel to the warp or wale direction of the fabric.

6.2 If the textile to be tested is a yarn, knit it into a fabric and use three specimens 10 × 5 cm (4 × 2 in.) with the longer dimension parallel to the wale direction of the fabric.

6.3 Sample preparation.

6.3.1 White cotton fabric, multifiber No. 1, No. 10, FA or FB. Prepare pieces with a 5 cm (2 in.) square of multifiber cloth or white cotton fabric (as required) sewn, stapled or suitably attached along one 5 cm (2 in.) edge of the test specimen and in contact with the face of the material. When multifiber test cloth is used, attach it so that each of the six fiber stripes is along the 5 cm (2 in.) edge of the specimen with wool on the right. The fiber stripes in the multifiber fabric will be parallel to the lengthwise direction of the test specimen.

6.3.2 Multifiber No. 10A or FAA. Prepare pieces with a 5 × 10 cm (2 × 4 in.) rectangle of multifiber cloth sewn, stapled or suitably attached centered along a 10 cm (4 in.) edge of the test specimen and in contact with the face of the material. Attach it so that each of the six fiber stripes will be parallel to the widthwise direction of the specimen. Attach and se-

cure the wool stripe at the top of the specimen to avoid fiber loss.

6.3.3 It is recommended that knitted fabrics be sewn or stapled at the four edges to equivalent size pieces of 80 × 80 cm bleached cotton fabric to avoid rolled edges and to assist in obtaining a uniform test result over the entire surface.

6.3.4 For pile fabric specimens with pile lay direction, attach the multifiber fabric at the top of the specimen with the pile lay direction pointing away from the top of the specimen.

6.3.5 When the textile to be tested is yarn, specimens may be tested in one of two ways.

6.3.5.1 Option 1. Knit yarn on an appropriate sample knitting machine. Prepare specimens and multifiber test fabrics according to 6.1-6.3. Keep one knitted specimen of each sample as an original.

6.3.5.2 Option 2. Prepare four 120-yd skeins of each yarn. Fold the skeins so that there is a uniform amount of yarn across a 2 in. width with a length appropriate for the procedure to be used. Keep one skein of each sample as an original. Sew or staple crock squares folded over each end of the layered yarn specimen. Attach a multifiber test fabric to one end.

7. Procedure

7.1 Prepare a bag for each specimen with inside dimensions of 10 × 10 cm (4 × 4 in.) using the undyed cotton twill cloth (see 5.4) by sewing together two squares of this cloth around three sides. Place the specimen and 12 steel discs inside the bag (see 5.3). Close the bag by any convenient means, such as sewing.

7.2 In a hood, prepare the perchloroethylene/detergent solution. To a 1000 mL volumetric flask filled partially with perchloroethylene, add 10 mL of detergent, (Perk Sheen 324). Shake or stir. Add perchloroethylene until the total volume equals 1000 mL. Add 0.6 mL water. Shake or stir until the solution is no longer cloudy. This mixture produces a 1% charge volume/volume at 75% RH.

7.3 In a hood, place the bag containing the specimen and the steel discs in the standard 500 mL (1 pt) stainless steel container and add 200 mL perchloroethylene detergent solution at $30 \pm 2^\circ\text{C}$ ($86 \pm 4^\circ\text{F}$). Close the container and agitate the specimen for 30 min at $30 \pm 2^\circ\text{C}$ ($86 \pm 4^\circ\text{F}$) in the specified equipment (see 11.4).

7.4 Place the container in an adequately ventilated hood. Remove the bag from the container, withdraw the specimen and place the specimen between layers of absorbent paper or cloth to remove surplus solvent. Air dry the specimen in a hood. Air at a temperature not exceeding 65°C (149°F).

7.5 Allow specimens to condition at $65 \pm 2\%$ RH and $20 \pm 1^\circ\text{C}$ ($68 \pm 2^\circ\text{F}$) for 1 h

before evaluating.

7.6 Prepare the tested specimens and staining fabric for evaluation by trimming off raveled yarns and lightly brushing off any loose fiber and yarn on the fabric surfaces. Brush pile fabric specimens in required direction to restore them as nearly as possible to the same pile angle as the untreated specimens. Specimens should be smoothed or flattened if there are wrinkles. Specimens may be mounted on cards to facilitate identification and handling in their evaluation. Mounting must not interfere with rating as specified in AATCC Evaluation Procedures 1 (Gray Scale for Color Change), 2 (Gray Scale for Staining), and 3 (AATCC Chromatic Transference Scale). For consistency in backing material, use a white mounting card with Y tristimulus value of at least 85%.

7.6.1 Yarn skein specimens should be combed and brushed for improved alignment of yarns before comparison with the unwashed original. The original specimens may also need further combing and brushing for uniformity of appearance.

8. Evaluation and Calculation

8.1 Evaluation of Color Change.

8.1.1 Rate the color change of the test specimens using the Gray Scale for Color Change. (Usage of the scale is discussed in Evaluation Procedure 1.) For improved precision and accuracy, the specimens should be rated by more than one rater.

Grade 5—negligible or no change as shown in Gray Scale Step 5.

Grade 4.5—change in color equivalent to Gray Scale Step 4-5.

Grade 4—change in color equivalent to Gray Scale Step 4.

Grade 3.5—change in color equivalent to Gray Scale Step 3-4.

Grade 3—change in color equivalent to Gray Scale Step 3.

Grade 2.5—change in color equivalent to Gray Scale Step 2-3.

Grade 2—change in color equivalent to Gray Scale Step 2.

Grade 1.5—change in color equivalent to Gray Scale Step 1-2.

Grade 1—change in color equivalent to Gray Scale Step 1.

8.1.2 The color change can be quantitatively determined between the original sample and a test specimen using a suitable colorimeter or spectrophotometer (see AATCC Evaluation Procedure 7, Instrumental Assessment of the Change in Color of a Test Specimen).

8.2 Evaluation of Staining.

8.2.1 Rate staining by using the Gray Scale for Staining or the AATCC Chromatic Transference Scale. (Usage of the scales is discussed in Evaluation Procedures 2 and 8.) The scale used should be indicated when reporting the test results

as follows:

Grade 5—negligible or no color transfer. Grade 4.5—color transfer equivalent to Step 4-5 on the Gray Scale for Staining or Row 4.5 on the 9-step AATCC Chromatic Transference Scale.

Grade 4—color transfer equivalent to Step 4 on the Gray Scale for Staining or Row 4 on the 9-step AATCC Chromatic Transference Scale.

Grade 3.5—color transfer equivalent to Step 3-4 on the Gray Scale for Staining or Row 3.5 on the 9-step AATCC Chromatic Transference Scale.

Grade 3—color transfer equivalent to Step 3 on the Gray Scale for Staining or Row 3 on the 9-step AATCC Chromatic Transference Scale.

Grade 2.5—color transfer equivalent to Step 2-3 on the Gray Scale for Staining or Row 2.5 on the 9-step AATCC Chromatic Transference Scale.

Grade 2—color transfer equivalent to Step 2 on the Gray Scale for Staining or Row 2 on the 9-step AATCC Chromatic Transference Scale.

Grade 1.5—color transfer equivalent to Step 1-2 on the Gray Scale for Staining or Row 1.5 on the 9-step AATCC Chromatic Transference Scale.

Grade 1—color transfer equivalent to Step 1 on the Gray Scale for Staining or Row 1 on the 9-step AATCC Chromatic Transference Scale.

8.2.2 The color transferred to the multifiber fabric or white cotton square of 6.3.1 can be quantitatively determined by measuring the color difference between a piece of the original material and the stained material. Using a suitable colorimeter or spectrophotometer, the No. 10A multifiber material has sufficient width to be within the aperture diameter capability of many instruments.

8.3 Calculation.

8.3.1 Average the observations made on each sample (means of judgement of 3 specimens).

9. Calculating and Reporting Results

9.1 Average the number of observations made on each sample (means of judgments on each of 3 specimens). Report the average to the nearest tenth of a grade point.

9.2 Report the test method number.

9.3 Report the grade number determined for color change in 9.1 and the staining grade number for the evaluated fibers in the multifiber test fabric and/or staining fabric as determined in 9.2.

9.4 State which scale (Gray Scale for Staining or AATCC Chromatic Transference Scale) was used in evaluating staining (see 11.9).

9.5 State whether multifiber No. 1, No. 10 or No. 10A was used, and if the cotton print cloth was employed to avoid knit curling.

10. Precision and Bias

10.1 *Precision.* On one fabric, three specimens were tested by each of two operators in three trials. The specimens were rated by two evaluators. The average grade for the two raters and three specimens was determined. This was considered the unit of measure of this test.

10.2 The components of variance as standard deviations of the color change grades were calculated to be as follows:

Single operator	0.03
Within laboratory	0.11

10.3 *Bias.* The true value of the color change can only be defined in terms of the test method. Within this limitation, the test method has no known bias.

11. Notes

11.1 This test method covers colorfastness to drycleaning only; it does not cover the ef-

fects of water spotting, solvent spotting and steam pressing which are normally involved in commercial drycleaning practice. For testing the durability of applied designs and finishes see AATCC Method 86, Durability of Applied Designs and Finishes to Drycleaning.

11.2 Perchloroethylene is used in this test because (a) it is the most used solvent in commercial drycleaning in the USA, and (b) it is slightly more severe in solvent action than petroleum. A color which is not affected by perchloroethylene will not be affected by petroleum solvents, whereas the converse is not always true.

11.3 Available from Publications Office, ACGIH, Kemper Woods Center, 1330 Kemper Meadow Dr., Cincinnati OH 45240; tel: 513/742-2020.

11.4 Available from SDL Atlas L.L.C., 1813A Associate Lane, Charlotte NC 28217; tel: 704/329-0911; fax: 704/329-0914; e-mail: info@sdlatlas.com.

11.5 Available from Testfabrics Inc., P.O. Box 26, 415 Delaware St., W. Pittston PA 18643; tel: 570/603-0432; fax: 570/603-0433; e-mail: testfabric@aol.com.

11.6 Multifiber test fabrics No. 1, No. 10 and No. 10A are available from Testfabrics Inc., P.O. Box 26, 415 Delaware St., W. Pittston PA 18643; tel: 570/603-0432; fax: 570/603-0433; e-mail: testfabric@aol.com. Multifiber test fabrics FA, FB and FAA are available from Textile Innovators Corp., div. of SDL Atlas L.L.C., P.O. Box 8, 101 Forest St., Windsor NC; tel: 252/794-9703; fax: 252/794-9704; e-mail: tic@sdlatlas.com. Bleached cotton test fabric in 32 × 32 ends × picks/cm (80 × 80 ends × picks/in.) construction, 136 ± 10 g/m² (4.0 ± 0.3 oz/yd²) and without fluorescent whitening agent is available from both suppliers.

11.7 Available from AATCC, P.O. Box 12215, Research Triangle Park NC 27709; tel: 919/549-8141; fax: 919/549-8933; e-mail: orders@aatcc.org.

11.8 Available from Adco Inc., 900 W. Main St., P.O. Box 999, Sedalia MO 65301; tel: 660/826-3300 or 800/821-7556; fax: 660/826-1361; e-mail: sales@adco-inc.com.

11.9 For very critical evaluations and in cases of arbitration, grades must be based on the Gray Scale for Staining.

Colorfastness to Heat: Hot Pressing

Developed in 1969 by AATCC Committee RR54; revised 1973, supersedes AATCC 5-1962; reaffirmed 1976, 1979, 1984, 1989; editorially revised 1981, 1985, 1986, 1991, 2001, 2002; editorially revised and reaffirmed 1994, 1999, 2004. Technically equivalent to ISO 105-X11.

1. Purpose and Scope

1.1 This test method is intended for determining the resistance of the color of textiles of all kinds and in all forms to color change, and color transfer when subjected to hot pressing. Tests are given for hot pressing when the fabric is dry, damp and wet. The textile end use usually determines which tests should be made.

2. Principle

2.1 Dry Pressing. The dry specimen is pressed with a heating device of a specified temperature, time and weight.

2.2 Damp Pressing. The dry specimen is covered with a wet, undyed cotton cloth and pressed with a heating device of a specified temperature, time and weight.

2.3 Wet Pressing. The wet specimen is covered with a wet, undyed cotton cloth and pressed with a heating device of specified temperature and weight.

3. Terminology

3.1 **colorfastness**, n.—the resistance of a material to change in any of its color characteristics, to transfer of its colorant(s) to adjacent materials or both, as a result of the exposure of the material to any environment that might be encountered during the processing, testing, storage or use of the material.

3.2 **hot pressing**, n.—a process for smoothing and possibly shaping textile products by applying mechanical pressure with heat, either dry or in the presence of moisture.

4. Safety Precautions

NOTE: These safety precautions are for information purposes only. The precautions are ancillary to the testing procedures and are not intended to be all inclusive. It is the user's responsibility to use safe and proper techniques in handling materials in this test method. Manufacturers MUST be consulted for specific details such as material safety data sheets and other manufacturer's recommenda-

tions. All OSHA standards and rules must also be consulted and followed.

4.1 Good laboratory practices should be followed. Wear safety glasses in all laboratory areas.

5. Apparatus and Materials

5.1 Heating device, providing even heat transfer to the specimen from the top by close contact at a controlled temperature (see 7.1, 12.1, 12.2 and 12.5) and giving a pressure on the specimen of $40 \pm 10 \text{ g/cm}^2$ (see 12.4).

5.2 A smooth heat resistant sheet (see 12.3 and 12.9).

5.3 Wool flannel of approximately 260 g/m^2 (see 12.4). Two layers of this material are used to make a pad of approximately 3 mm thickness. Similar, smooth wool fabrics or felt to give a pad about 3 mm thick could be used.

5.4 An undyed, bleached and not mercerized cotton cloth, with a smooth surface $100\text{-}130 \text{ g/m}^2$.

5.5 Gray Scale for Color Change (see 12.8).

5.6 Gray Scale for Staining (see 12.8).

5.7 AATCC Chromatic Transference Scale (see 12.8).

6. Test Specimen

6.1 If the textile to be tested is fabric, a piece $12 \times 4 \text{ cm}$ is required.

6.2 If the textile to be tested is yarn or thread, knit it into a fabric and use a piece $13 \times 4 \text{ cm}$ or wind it around a piece of thin inert material $12 \times 4 \text{ cm}$ to obtain the area of the textile for test.

7. Procedure

7.1 The following temperatures are used (see 12.1):

$110 \pm 2^\circ\text{C}$

$150 \pm 2^\circ\text{C}$

$200 \pm 2^\circ\text{C}$

When necessary, other temperatures may be used, provided they are specifically noted in the report (see Table I).

7.2 Specimens of materials that have been subjected to any heat or drying treatment must be allowed to condition (by exposure to air at $65 \pm 2\% \text{ RH}$ and a temperature of $20 \pm 2^\circ\text{C}$), before they are tested.

7.3 The bottom plate of the heating device is covered with the heat resistant sheeting (see 5.2, 12.3) wool flannel (see 5.3, 12.3) and dry, undyed cotton cloth (see 5.4, 12.3 and 12.4).

7.4 Dry Pressing. Place dry specimen on top of the cotton cloth covering the wool flannel pad (see 7.3, 12.3). Lower top plate of heating device and leave specimen for 15 s at the specified pressing temperature.

7.5 Damp Pressing. Place dry specimen on top of the cotton cloth covering the wool flannel padding (see 7.3, 12.3). Soak a piece of undyed cotton cloth $12 \times 4 \text{ cm}$ in distilled water, and squeeze or extract it to contain its own weight of water. Place the wet cloth on top of the dry specimen. Lower the top plate of the heating device and leave specimen for 15 s at the specified pressing temperature.

7.6 Wet Pressing. Soak the dyed specimen and a piece of undyed cotton cloth $12 \times 4 \text{ cm}$ (see 5.4) in distilled water and squeeze or extract them to contain their own weight of water. Place the wet specimen on top of the dry cotton cloth covering the wool flannel pad (see 7.3, 12.3) and place the wet, undyed cloth on the specimen. Lower the top plate of the heating device and leave specimen for 15 s

Table I—Safe Ironing Temperature Guide

Class 0	Class I	Class II	Class III	Class IV
Below 121°C	121-135°C	149-163°C	177-191°C	204°C and Above
Modacrylic 93-121°C Olefin (Polyethylene) 79-121°C	Acetate Olefin (Polypropylene)	Acrylic Azlon Nylon 6	Nylon 6,6 Polyester	Cotton Fluorocarbon
Rubber 82-93°C	Silk	Spandex Wool		Glass Hemp, Jute, Ramie Linen Rayon, Viscose Triacetate (heat set)
Saran 66-93°C				
Vinyon 54°C				

at the specified pressing temperature.

8. Evaluation Method for Alteration in Color (Shade and Strength)

8.1 Assess the change in color of the specimen with the Gray Scale for Color Change immediately and again after the specimen has been allowed to condition for 4 h in the standard atmosphere ($20 \pm 2^\circ\text{C}$ and $65 \pm 2\%$ RH):

Grade 5—negligible or no change as shown in Gray Scale Step 5.

Grade 4.5—change in color equivalent to Gray Scale Step 4-5.

Grade 4—change in color equivalent to Gray Scale Step 4.

Grade 3.5—change in color equivalent to Gray Scale Step 3-4.

Grade 3—change in color equivalent to Gray Scale Step 3.

Grade 2.5—change in color equivalent to Gray Scale Step 2-3.

Grade 2—change in color equivalent to Gray Scale Step 2.

Grade 1.5—change in color equivalent to Gray Scale Step 1-2.

Grade 1—change in color equivalent to Gray Scale Step 1.

9. Evaluation Method for Staining

9.1 Rate staining by the AATCC Chromatic Transference Scale or the Gray Scale for Staining (see 12.10):

Grade 5—negligible or no color transfer.

Grade 4.5—color transfer equivalent to Step 4-5 on the Gray Scale for Staining or Row 4.5 on the 9-step AATCC Chromatic Transference Scale.

Grade 4—color transfer equivalent to Step 4 on the Gray Scale for Staining or Row 4 on the 9-step AATCC Chromatic Transference Scale.

Grade 3.5—color transfer equivalent to Step 3-4 on the Gray Scale for Staining or Row 3.5 on the 9-step AATCC Chromatic Transference Scale.

Grade 3—color transfer equivalent to Step 3 on the Gray Scale for Staining or Row 3 on the 9-step AATCC Chromatic Transference Scale.

Grade 2.5—color transfer equivalent to Step 2-3 on the Gray Scale for Staining or Row 2.5 on the 9-step AATCC Chromatic Transference Scale.

Grade 2—color transfer equivalent to Step 2 on the Gray Scale for Staining or Row 2 on the 9-step AATCC Chromatic Transference Scale.

Grade 1.5—color transfer equivalent to Step 1-2 on the Gray Scale for Staining or Row 1.5 on the 9-step AATCC Chromatic Transference Scale.

Grade 1—color transfer equivalent to Step 1 on the Gray Scale for Staining or Row 1 on the 9-step AATCC Chromatic Transference Scale.

10. Report

10.1 Report the test procedure (dry, damp or wet) and the temperature of the heating device. Report the numerical rating for change in color immediately after testing and after conditioning for 4 h at $65 \pm 2\%$ RH and a temperature of $20 \pm 2^\circ\text{C}$. Report the numerical rating for the staining of the undyed cotton cloth. Report which scale was used for evaluating staining.

11. Precision and Bias

11.1 *Precision.* Precision for this test method has not been established. Until a precision statement is generated for this test method, use standard statistical techniques in making any comparisons of test results for either *within-laboratory* or *between-laboratory* averages.

11.2 *Bias.* Colorfastness to heat, hot pressing, can be defined only in terms of a test method. There is no independent method for determining the true value. As a means of estimating this property, the method has no known bias.

12. Notes

12.1 The pressing temperature depends to a large extent on the type of fiber and on the construction of the fabric or garment. In the case of blends, it is further suggested to use the temperature appropriate to the fiber with the lowest heat resistance. The indicated temperatures cover three commonly used pressing conditions.

12.2 A suitable heating device is the current production of the Atlas Scorch Tester. Older Scorch Tester units now in use can be modified to make them suitable by changing of the hinge on the head assembly and by modifica-

tion of the heat controlling unit. Both the Scorch Tester and modification kit for older units are available from SDL Atlas L.L.C., 1813A Associate Lane, Charlotte NC 28217; tel: 704/329-0911; fax: 704/329-0914; e-mail: info@sdlatlas.com.

12.3 The smooth heat resistant sheet (see 12.9) is used for insulation and should be smooth and not warped. It is best to complete specimen assembly on the heat resistant sheet before placing it on the heating device. The sheet should be cooled and the wet wool should be dried between tests. This insulating material must be used, whether the bottom plate is heated or not, to prevent heat to or from the bottom of the test assembly.

12.4 In order to obtain the pressure per unit area $40 \pm 10\text{g/cm}^2$ the total area of the wool flannel padding should bear a suitable relationship to the mass of the plate pressing down on the padding. If the fabric to be tested has an appreciable thickness, it is necessary either to increase the area of the test specimen; or to augment the pressure-bearing surface using a suitable template made from the same material as the test specimen. If the plates of the heating device are smaller than the specimen size, the pressure depends on the design of the apparatus (ratio of mass and area of top plate).

12.5 During the heating-up period of the heating device and between the actual test periods, both plates of the heating device should be in contact to insure a uniform distribution.

12.6 For less critical testing, a household iron may be used; but its temperature should be measured with a surface pyrometer or with temperature sensitive papers. The iron should be weighted so that its area and total weight are in the approximate ratio to exert a pressure of $40 \pm 10\text{g/cm}^2$. However, due to temperature fluctuation during on-off differences over the iron surface, the accuracy and reproducibility are limited. When a hand iron is used, it must be stated in the report.

12.7 Fabrics for this test method are available from Textile Innovators Corp., div. of SDL Atlas L.L.C., P.O. Box 8, 101 Forest St., Windsor NC; tel: 252/794-9703; fax: 252/794-9704; e-mail: tic@sdlatlas.com.

12.8 Available from AATCC, P.O. Box 12215, Research Triangle Park NC 27709; tel: 919/549-8141; fax: 919/549-8933; e-mail: orders@aatcc.org.

12.9 Available from SDL Atlas L.L.C., 1813A Associate Lane, Charlotte NC 28217; tel: 704/329-0911; fax: 704/329-0914; e-mail: info@sdlatlas.com.

12.10 For very critical evaluations and in the case of arbitration, ratings must be based on the geometric Gray Scale for Staining.

Electrostatic Propensity of Carpets

Developed in 1969 by AATCC Committee RA32; revised 1975, 1979, 1991, 2001; reaffirmed 1986, 1996. Related to ISO 6356.

1. Purpose and Scope

1.1 This test method assesses the static-generating propensity of carpets developed when a person walks across them by using controlled laboratory simulation of conditions, which may be encountered in practice. The simulation is focused on the use of those conditions, which are known from experience to be strong contributors to excessive accumulation of static charges.

1.2 This test method does not include standards of performance. The specification requirements pertinent to any given application can vary considerably, depending on the specific demands of the application. Specifiers should give attention to the variability of the method as described below in Section 11.

2. Principle

2.1 Build-up of a static charge on a person walking across a carpet under conditions of low atmospheric humidity has been recognized as a classic example of the triboelectric effect, whereby a separation of electrical charges is produced when two dissimilar surfaces in contact are separated. The magnitude of the charge separation and the resultant voltage on the person vary under the influence of many factors. The most important factors for the purpose of this test are:

(a) the chemical and physical characteristics of the two materials brought into contact, rubbed and separated; i.e., the shoe soles and carpet;

(b) the surface contamination on one or both;

(c) the nature of the rubbing and/or separation, i.e., the method of walk, including the height of the shoe above the carpet; and

(d) the ambient conditions (especially the relative humidity).

2.2 A carpet brought to moisture equilibrium at controlled atmospheric conditions is walked on by a test operator in a specified manner with specified shoe soles and heels. The static charge, which builds up on the operator, is monitored continuously by a voltage indicator with a recorder.

2.3 The maximum voltage, generated on the person by the accumulated charge,

measured during the test period is *defined* as the static-generating propensity of the carpet under the conditions of the test.

3. Terminology

3.1 **electrostatic propensity**, n.—the ability to produce and accumulate an electrostatic charge.

NOTE: For the purposes of this test, it is the *resultant voltage* on a person walking across the surface of a textile floor covering under specified conditions, which has been caused by the accumulation of an electrostatic charge on the body.

4. Safety Precautions

NOTE: These safety precautions are for information purposes only. The precautions are ancillary to the testing procedures and are not intended to be all inclusive. It is the user's responsibility to use safe and proper techniques in handling materials in this test method. Manufacturers MUST be consulted for specific details such as material safety data sheets and other manufacturer's recommendations. All OSHA standards and rules must also be consulted and followed.

4.1 Good laboratory practices should be followed. Wear safety glasses in all laboratory areas.

4.2 All chemicals should be handled with care.

4.3 Isopropyl alcohol is a flammable liquid and should be stored in the laboratory only in small containers away from heat, open flames and sparks.

4.4 Manufacturer's safety recommendations should be followed when operating laboratory testing equipment.

4.5 Ground all electrical equipment.

4.6 High-voltage sources should have an internal impedance of not less than 1×10^8 ohm (or the maximum output current limited to 1 milliampere) to avoid shock hazard in calibration of the detection system.

5. Apparatus and Materials

5.1 A room that can be maintained at a temperature of $21 \pm 1^\circ\text{C}$ and at $20 \pm 2\%$ RH, and suitable means for monitoring these conditions. Special requirements of end-use may dictate the use of other testing conditions (e.g., for aircraft or for controlled-humidity environments) and the test facility should be capable of achieving and maintaining those conditions.

5.1.1 The room should be of such dimensions and so arranged that the test operator comes no closer than approximately 600 mm to extraneous grounded or charged surfaces (such as walls or workbenches) during testing and should be equipped with open-wire shelves, racks or horizontal rods suitable for hanging carpet samples for conditioning. Air must pass freely around all surfaces of the samples to facilitate moisture equilibration.

5.2 Test sandals should be used only for testing carpet. New test sandals should be cleaned before use as prescribed in 8.7.1. Soles must be attached to the sandals by gluing and/or stitching. Tacks or rivets must not be used.

5.2.1 One pair of AATCC TM 134 sandals (see 12.1) manufactured with XS 664 P-HK Neolite soles. A second pair of Neolite test shoes or sandals with self-adhesive (i.e., replaceable) suede leather attached to the shoe sole. The second pair of Neolite shoes or sandals must be dedicated to this use only.

5.2.2 Reagent grade isopropyl alcohol and cheesecloth.

5.3 Electrostatic detection and recording means for voltages up to at least 20 kV (see 12.2).

5.3.1 Instrument response should have a high input impedance and be suitably damped such that a steady recorder or meter indication of 3000 V will, when the input is grounded, decay to 1500 V in not less than 1 s or more than 3 s (this corresponds to a time constant of 1.4-4.3 s). This response should be effected without appreciably altering the input capacitance, which should not be more than 30 pF (see Appendix A).

5.4 A grounded metal plate approximately 1200×1200 mm.

5.5 A standard 1350 g/m^2 rubberized jute/hair cushion underlay (see 12.1) at least 1200×1200 mm. The vertical resistance through the cushion shall not be less than 10^{12} ohms (see 12.6).

5.6 A set of AATCC TM 134 AATCC Static Control Carpets (see 12.1) consisting of static unprotected and static protected versions.

5.7 An optional metronome.

5.8 An optional handheld blowing-fan balanced ionizer.

6. Specimens

6.1 Cut each carpet test specimen to a size of approximately 900×900 mm or 1000×1000 mm. If test specimens are

less than this size, multiple specimens may be pieced together to reach the required test size.

7. Conditioning

7.1 Condition specimens under the required test conditions, $21 \pm 1^\circ\text{C}$ and $20 \pm 2\%$ RH, for a minimum of 48 h prior to testing. This will equilibrate the moisture content of the specimens to the test conditions. The temperature and relative humidity should be automatically recorded or periodically manually noted and recorded during the conditioning period.

7.1.1 Hang or lay specimens in such manner that free circulation of air over both surfaces is possible.

8. Procedure

8.1 Test AATCC TM 134 Static Unprotected Control Carpet *without* an underlay (to avoid charging the underlay) and the Static Protected Control Carpet *with* an underlay at the beginning of each testing session. If the results are outside of the test laboratory's Control Chart Control Limits, then seek the cause of the deviation and correct the problem. Check relative humidity and temperature (current values and recorded values during the specimen conditioning period) (see 5.1). Test backup Control Carpets if available (see 5.6), reclean soles (see 8.7) and check instrument calibration. Use a blowing-fan, handheld, balanced high-voltage ionizer to neutralize any charge on the underlay pad between tests and prior to testing any specimen, moving it slowly over the entire surface at a height of about 100-200 mm above it for at least 1 min.

8.2 Test the specimen once a day until two reproducible voltages are obtained. Voltages are considered reproducible when consecutive tests agree within 10% or 0.5 kV, whichever is greater. Leaving the specimen in the test chamber overnight should allow any static charges to be dissipated. This process may be accelerated by using a blowing-fan, balanced high-voltage ionizer to neutralize any charges. If an ionizer is used to thoroughly neutralize the specimen (held about 100-200 mm above the specimen and moved slowly over its entire surface, requiring approximately 1-2 min), the same specimen may be retested immediately.

8.3 Test the specimen over the standard underlay (see 5.5), which is placed on the grounded metal plate.

8.3.1 Residual static charges on the specimen and underlay have been found to be a major source of error. Residual charges should decay naturally over a period of several hours. Specimens should be hung undisturbed for a minimum of 4 h, or thoroughly neutralized with a blow-

ing-fan, balanced high-voltage ionizer, prior to each testing, as above.

8.3.2 Lay the underlay on the grounded metal plate, rubberized side up. Avoid dragging the underlay across the surface or rubbing different parts of it together.

8.3.3 If a blowing-fan, balanced high-voltage ionizer is available, thoroughly and slowly cover the entire surface of the underlay with the ionizer output, holding the ionizer about 100-200 mm above the underlay. This will neutralize any residual charges from handling.

8.3.4 Lay the specimen on the underlay carefully to avoid excessive friction against the mat or rubbing different parts of it together.

8.3.5 If a blowing-fan, balanced high-voltage ionizer is available, thoroughly and slowly cover the entire surface of the sample with the ionizer output, holding the ionizer about 100-200 mm above the sample. This will neutralize any residual charges from handling.

8.3.6 Zero the test apparatus. Place clean test sandals (see 8.7) on the specimen, grasp the test probe and ground the test operator while standing off the specimen in stocking feet. Ensure that the recorder reads "0." Step into the clean test sandals specified for the test while standing on the specimen and holding the test probe, being careful not to move the sandals around on the specimen.

8.4 After following the procedure in 8.3, there should be very little voltage indication. Presence of significant voltage (more than 200 V) indicates excessive initial charge somewhere in the system and the procedures in 8.2 and 8.3 must be repeated to avoid possible significant errors. Since the location of the spurious charge is important in affecting the final test results, it is not sufficient to simply reground the test subject, although this will obviously create a new zero value.

8.5 If the carpet is not intended for installation over an underlay, then the specimen may be tested without an underlay. In such cases, test the specimen on the grounded metal plate and record the fact that the test was performed on the specimen mounted directly on a grounded surface. Otherwise, follow the procedure outlined in 8.3.

8.6 Proceed with the tests described below in 8.6.1. NOTE: Be sure to keep SEPARATE shoes or sandals for the Neolite and suede leather tests; do not remove the leather and test with the underlying Neolite, since it will be contaminated by the adhesive. Note that the samples and underlay must be discharged between repeat tests or between types of tests or between tests with different soles, in order to avoid errors. Discharge may be achieved by allowing natural discharge over 4 h or overnight, or neutralization with a blowing-fan, handheld balanced

high-voltage ionizer, as above.

8.6.1 Tests.

Test I—Step Test/Neolite Soles

Test II—Scuff Test/Neolite Soles

Test III—Step Test/Self-adhesive suede leather soles

Test IV—Scuff Test/Self-adhesive suede leather soles

8.6.2 **Step Test Procedure.** While holding the hand probe, walk on the specimen using a simple box step, lifting the sandals as close as possible to 80 mm above the specimen at the rate of 120 ± 10 steps per min (a metronome can be used). Always keep the plane of the sandal soles parallel to the plane of the specimen. Do not scuff or rub the sandals over the specimen. Cover the entire surface of the specimen during stepping, for a total test time of 1 min or until a consistent peak voltage is observed for each step. Touch the ground with the hand probe to bring the body voltage to "0." Neutralize the carpet and underlay prior to any further testing.

8.6.3 **Scuff Test Procedure.** While holding the probe, scuff (or wipe) as though wiping chewing gum from the bottom of both sandals. The wiping action is always in a backward motion. As above, the bottom of the sandal should reach a height of as close as possible to 80 mm above the specimen, parallel to the sample. Repeat scuffing at a rate of 60 ± 5 steps per min and continue the motion for about 1 min while covering the entire specimen. Touch the ground with the hand probe to bring the body voltage to "0." Neutralize the carpet and underlay prior to any further testing.

8.7 Remove and clean the sandal. Hang or lay the specimen on the conditioning rack. The procedures in 8.7.1 and 8.7.2 will usually suffice to clean the sandals. Sandals must be cleaned with extreme care after testing specimens, which have had surface-type (spray-on, topical) antistatic treatments (see 12.5). Failure to do so may transfer material from one specimen to another.

8.7.1 Clean Neolite sandal soles by swabbing with cheesecloth or paper towel moistened with isopropyl alcohol, using a fresh cheesecloth or paper towel. In case of extensive contamination, repeat this procedure, sand the sole with fine sandpaper to expose fresh material and clean again.

8.7.2 The suede leather soles are difficult to clean, once contaminated. Sanding the sole may remove the contamination. Other cleaning methods may contaminate the leather or change its electrical properties (such as water absorption from isopropanol/water cleaning solution). Replace these soles if sanding does not readily remove the contamination.

8.7.3 Store the test sandals in the controlled relative humidity of the test area.

8.8 Record the test parameters, including specimen identification, specimen tested “as received” or “cleaned,” date, temperature, relative humidity, sandal sole and walking procedures (Step or Scuff).

8.9 In case of any uncertainty about the consistency of the test conditions, retest the AATCC Static Control Carpets at the end of and throughout the testing session to assure that testing conditions have not changed. If the Control Carpet measurements are significantly different (outside of the test laboratory’s established Control Limits for the control specimens), then the specimen test results are unreliable.

9. Analysis of Results

9.1 The chart trace serves as a permanent record of the test and characterizes the carpet for electrostatic propensity. The maximum voltage (at the highest point of each step), the sign of the voltage and the rate-of-rise of voltage are characteristics available from the chart trace and have been found to be relevant to the performance of a carpet under use conditions similar to those of the test.

9.2 Maximum voltage, Step and Scuff. The maximum voltage is defined as the maximum achieved for several successive steps. An example is given in Fig. 1.

9.2.1 Rate of rise of voltage may be reported, Step and Scuff. The average rate of increase of voltage (in kV/s) is taken as the reported maximum voltage divided by the time required to reach that voltage from the start of the test walk.

9.3 Effect of contaminants. Carpets that have been contaminated by spills, soiling, contact with other carpets or materials that have removable chemical components, etc., will yield results that are different from clean carpets. Since the triboelectric effect depends upon the difference between the flooring and the shoes, these contaminants may increase

or decrease the measured electrostatic propensity. Similarly, non-permanent topical treatments will affect the results; the variation of such treatments over time and after cleaning should be considered by the test requester. To remove contaminants, a hot-water extraction procedure is recommended, such as AATCC Method 171, Carpets: Cleaning of; Hot Water Extraction Method.

9.4 Effect of sole materials. Very large differences in laboratory and field results will often occur as a result of use of different shoe sole materials. The triboelectric, surface roughness and conductivity characteristics of the materials are important. Higher conductivity soles will tend to suppress the accumulation of charge on a person particularly when carpets having static-control filaments are tested.

9.4.1 Neolite XS 664 P-HK has been chosen as the primary reference material because its static performance is much like that of many common shoe soles; it is easy to keep clean and its chemical and physical properties are believed to be quite uniform. Its triboelectric properties are distinct from those of nylon, the dominant carpet fiber polymer. Other types of carpet should also be tested with the secondary reference material for a more complete characterization of the static propensity of the carpet.

9.4.2 Suede leather has been chosen as the secondary reference material because typically it is representative of a certain class of leathers whose triboelectric performance differs significantly from that of Neolite soles, in that they tend to give high values on acrylic, polyester and polypropylene carpets.

9.4.3 For some purposes it may be desirable or necessary to characterize carpet performance with special shoes, such as ESD (electrostatic discharge) control footwear. Equivalent test procedures can be conducted with any relevant sole materials or shoes, but such tests should be

considered supplementary information only.

10. Report

10.1 Two reproducible voltages and their average should be reported (see 8.2) for the Step test method with the highest voltage or for each test method as requested, with the polarity indicated as positive or negative. (The polarity does not affect the impact of static buildup on people or equipment, but does serve a diagnostic purpose. Only the magnitude of the results should be considered when comparing the test results with floor-covering static-control specifications.) Scuff test measurements should also be reported for comparison; Scuff test measurements are more variable *within-lab* and *between-lab* than step test results. If Scuff test measurements differ from Step test results by more than 2.5 kV, the report should explain that this may be an indication that a topical treatment or contaminant may be present on the specimen.

10.2 Report the AATCC Static Control Carpet test results for the same day(s) as the specimen test(s), the laboratory’s Upper Control Limit and Lower Control Limit, and the laboratory’s established measurement standard deviation for each control, for each type of test.

10.3 The test report should include the testing conditions (relative humidity and temperature), test method and version, and any observations or apparent anomalies.

10.4 The report should state whether an ionizer was used to neutralize charges on the samples prior to each test. If specimens were tested without an underlay, the presence or absence of the underlay should be noted.

10.5 The report should state whether the carpet was tested “as received” or what preparation technique (e.g., “cleaned using AATCC Method 171”) was used. A caveat on the use of AATCC Method 134 should be included which states, “The results of this test relate to the sample of carpet tested. Its static performance may be altered in service as a result of wear, soiling, cleaning, temperature, relative humidity, etc.”

11. Precision and Bias

11.1 Users of data from AATCC Method 134 should be aware that large variations in results have been noted during interlab and intralab testing. Preliminary evaluation of the round robin test results, in the range of 0-6 kV, shows that differences of less than approximately 0.5 kV are not significant, and this must be considered when comparing test results to specification requirements. An initial study on AATCC TM 134 Static Pro-

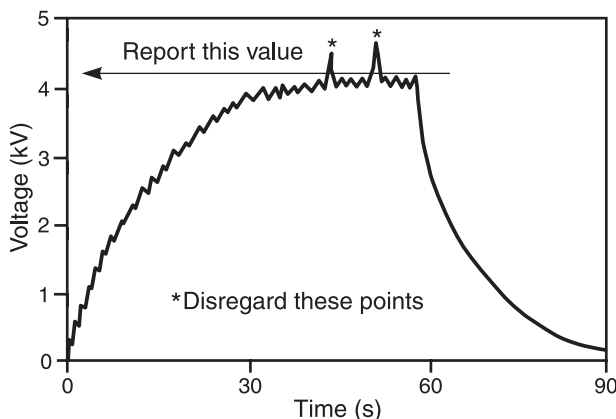

Fig. 1—Typical chart trace indicating maximum voltage.

tected Control Carpet with shoes fitted with XS 664 P-HK Neolite soles (not AATCC TM 134 sandals) produced a Step procedure average voltage of 2.7 kV with a standard deviation of 0.3 kV, based on data from seven test sites.

12. Notes

12.1 AATCC TM 134 sandals, both large and small sizes, suede leather, rubberized jute/hair cushion carpet underlay and AATCC TM 134 Static Control Carpets (Protected and Unprotected) are available from AATCC, P.O. Box 12215, Research Triangle Park NC 27709; tel: 919/549-8141; fax: 919/549-8933; e-mail: orders@aatcc.org.

12.2 A suitable electrometer, Model 617 (digital) or Model 610C (analog), a 1000:1 voltage divider probe Model 6103C, and a recorder Model 370 are available from Keithley Instruments, 28775 Aurora Rd., Cleveland OH 44139; tel: 440/248-0400. This apparatus may require slight modification to conform to requirements of 5.3.1.

12.3 Two methods for electrometer damping testing are outlined in Appendix A.

12.4 Handheld blowing-fan, balanced high-voltage ionizers are available from a number of distributors under various names, including ionized-air blowers by Simco, 3M, Ion Systems and others. These are typically 4" fans with integral electronics and high-voltage ion-emission points.

12.5 The test laboratory must maintain a record of AATCC Static Control Carpet results, and generate suitable Control Charts therefrom. The Upper Control Limit and Lower Control Limit Values established through this analysis are to be used to define when all of the experimental conditions and equipment parameters are operating within the expected range. Non-random long-term drift in control carpet readings should be investigated to determine the nature of the changes that have taken place and corrective action taken.

12.6 If required, use National Fire Protection Association Test Method 99 or ESD/EOS STM 7.1 to measure resistance. For products intended to be installed in electrostatic-discharge-sensitive areas (i.e., electronics component manufacturing or assembly areas), several test methods developed by the Electro-

static Discharge Association (ESD Association) may be appropriate (ESD/EOS Standard Test Methods).

12.7 If the shoe soles or heels become permanently contaminated by testing carpets with topical antistats or yarn overfinishes, they should then be resoled or discarded immediately. The standard reference carpets recommended in the method can be very helpful in determining when soles or heels are contaminated, but these are also subject to contamination by contaminated shoes. Spare reference carpets should be stocked in case of contamination carry-over when testing the shoe condition.

Appendix A Electrometer Damping Testing

A.1 Two methods to test the damping are as follows:

A.1.1 Electrometer with a high-voltage power supply capable of at least 3000 volts:

(a) Set up the electrometer (and recorder, if available) for at least 3 kV maximum range (10 kV preferred).

(b) Connect the power supply high-voltage output to the electrometer input (to the divider probe tip for Keithley 610C or similar equipment).

(c) Check the power line grounds, and if in doubt, run a line from both the electrometer and power supply ground terminals to a common ground.

(d) After allowing the electrometer and power supply to warm up per the manufacturer's specifications, adjust the power supply output for a steady 3 kV reading on the electrometer.

(e) Switch the power supply off for a moment and observe the electrometer response. Most commercial high-voltage units have a built-in grounding of the output when turned off for safety reasons. If the unit in use does not show grounding when switched off, a properly shielded single pole, double throw switch must be connected to the electrometer input so it can be quickly switched from high-voltage to ground.

(f) With a steady 3 kV reading on the electrometer (and recorder), switch the electrometer input to ground (see Section 5) and measure the time it takes the voltage reading to drop to 1.5 kV. This should be between 1-3 s.

A.1.2 Electrometer without a high-voltage power supply:

(a) Set up as for a standard carpet test using a sample known to generate reading of 5 kV or over (AATCC TM 134 Static Unprotected Control Carpet).

(b) Have the operator proceed to walk (or scuff) test normally and observe the electrometer reading.

(c) When the reading reaches 5 kV or more, the operator should stop moving and watch the reading without touching anything.

(d) When the voltage has leaked off enough to drop the reading to 3 kV, the operator will ground the electrometer input (touch probe tip to ground, use a jumper wire, or a wire and switch combination). Record the time it takes the reading to drop to 1.5 kV.

(e) This procedure should be repeated five times or more, and the tests averaged to smooth out reading inaccuracies.

A.1.3 The decay to 50% of the original signal has been selected as a convenience to simplify the readout of the electrometer and recorder. The 1-3 s delay corresponds to a time constant ($t = 1/e$) 1.4-4.3 s.

Appendix B Damping Techniques

B.1 For electrometers with recorders, the preferred method of adjustment of response time is a filter network between electrometer and recorder. Details of how to select a network can be found in electronic handbooks under integrating or low pass filter headings.

B.2 An electrometer with an analog display often has a built-in response in the desired range. Modification of a non-complying unit should be referred to the manufacturer.

Dimensional Changes of Fabrics after Home Laundering

Developed in 1970 by AATCC Committee RA42; reaffirmed 1973, 2000; revised 1978, 1987, 1995, 2001, 2003 (with title change), 2004; editorially revised 1982, 1985, 1989, 1990, 1991, 1996, 1997; editorially revised and reaffirmed 1992. Related to ISO 3759.

1. Purpose and Scope

1.1 This test method is intended for the determination of dimensional changes of fabrics when subjected to home laundering procedures used by consumers. Four washing temperatures, three agitation cycles, two rinse temperatures and four drying procedures cover the common home care options available to consumers using current laundering machines.

2. Principle

2.1 The dimensional changes of fabric specimens subjected to home laundering care are measured using pairs of benchmarks applied to the fabric before laundering.

3. Terminology

3.1 **dimensional change**, *n.*—a generic term for changes in length or width of a fabric specimen subjected to specified conditions. The change is usually expressed as a percentage of the initial dimension of the specimen.

3.2 **growth**, *n.*—a dimensional change resulting in an increase of length or width of a specimen.

3.3 **laundering**, *n.*—of textile materials, a process intended to remove soils and/or stains by treatment (washing) with an aqueous detergent solution and normally including rinsing, extraction and drying.

3.4 **shrinkage**, *n.*—a dimensional change resulting in a decrease in the length or width of a specimen.

4. Safety Precautions

NOTE: These safety precautions are for information purposes only. The precautions are ancillary to the testing procedures and are not intended to be all inclusive. It is the user's responsibility to use safe and proper techniques in handling materials in this test method. Manufacturers MUST be consulted for specific details such as material safety data sheets and other manufacturer's recommendations. All OSHA standards and rules must also be consulted and followed.

4.1 Good laboratory practices should be followed. Wear safety glasses in all laboratory areas.

4.2 The 1993 AATCC Standard Reference Detergent may cause irritation. Care should be taken to prevent exposure to skin and eyes.

4.3 Manufacturer's safety recommendations should be followed when operating laboratory testing equipment.

5. Apparatus and Materials

5.1 Automatic washing machine (see 12.1).

5.2 Automatic tumble dryer (see 12.2).

5.3 Conditioning/drying racks with pull-out screens or perforated shelves (see 12.3).

5.4 Facilities for drip drying and line drying.

5.5 1993 AATCC Standard Reference Detergent (see 12.10 and 12.11).

5.6 Ballast of 920 × 920 mm (36 × 36 in.) hemmed pieces of bleached cotton sheeting (Wash load ballast type 1), or 50/ 50 polyester/cotton bleached plain weave (Wash load ballast type 3) (see 12.4 and 12.11).

5.7 Indelible ink marking pen (see 12.5) for use with suitable rule, tape, marking template or other marking device (see 12.6). Sewing thread may be used for making benchmarks.

5.8 Measuring devices.

5.8.1 Tape or rule marked in millimeters, eighths or tenths of an inch.

5.8.2 Tape or ruled template marked directly in percent dimensional change to 0.5% or smaller increment (see 12.6).

5.8.3 Digital Imaging System (see 12.7).

5.9 Scale with at least 5.0 kg (10.0 lb) capacity.

6. Test Specimens

6.1 Sampling and Preparation.

6.1.1 Samples from which dimensional change specimens are to be taken should be representative of the fabric processing stage, finishing treatment, research lab trial, pallet, lot or end-product stage.

6.1.2 Fabrics that are distorted in their unlaundered state may give deceptive dimensional change results when laundered by any procedure. In such cases, it is recommended that specimens not be taken from any distorted area of a fabric sample.

6.1.3 Tubular knitted samples should be slit and handled flat in a single layer. Only circular knitted fabrics produced on body-width machines are to be used as

specimens in their tubular form. Circular knitted fabrics made on body-width machines are ones to be used in garments with no side seams. Body-width tubular knitted garments and seamless garments (knit-to-wear) should be tested according to AATCC Method 150, Dimensional Changes of Garments after Home Laundering.

6.1.4 If fraying of specimens is expected in laundering, see 12.8.

6.1.5 Prior to marking, condition test specimens as directed in ASTM D 1776, Standard Practice for Conditioning and Testing Textiles. Condition each specimen for at least 4 h in an atmosphere of $21 \pm 1^\circ\text{C}$ ($70 \pm 2^\circ\text{F}$) and $65 \pm 2\%$ RH by laying each test specimen separately on a screen or perforated shelf of a conditioning rack.

6.1.6 Lay the sample on a flat surface. Do not allow any section of the sample to hang over the edge of the work table. Using a template for the selected test size, mark specimens parallel to the selvege or fabric length direction. Avoid use of the sample area within ten percent of the sample width. Specimens should be taken from areas with different lengthwise and widthwise yarns (see Fig. 1). Identify the length direction of the specimens before cutting them out of the sample. When possible, three specimens from each fabric should be used. One or two specimens may be used when insufficient fabric sample is available.

6.2 Marking.

6.2.1 Option 1: 250 mm (10.0 in.) benchmarks. Mark each 380 × 380 mm (15 × 15 in.) test specimen with three 250 mm (10 in.) pairs of benchmarks parallel to the test specimen length and three 250 mm (10 in.) pairs of benchmarks parallel to the test specimen width. Each benchmark must be at least 50 mm (2 in.) from all test specimen edges. Pairs of bench-

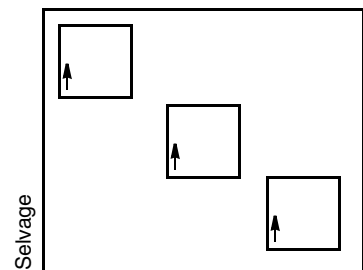

Fig. 1—Diagram for cutting fabric specimens.

marks in the same direction must be spaced approximately 120 mm (5 in.) apart.

6.2.2 Option 2: 460 mm (18.0 in.) benchmarks. Mark each 610 × 610 mm (24.0 × 24.0 in.) test specimen with three 460 mm (18.0 in.) pairs of benchmarks parallel to the test specimen length and three 460 mm (18.0 in.) pairs of benchmarks parallel to the test specimen width. Each benchmark must be at least 50 mm (2.0 in.) from all test specimen edges. Pairs of benchmarks in the same directions must be spaced approximately 250 mm (10 in.) apart.

6.2.3 Narrow Fabrics.

6.2.3.1 For test specimens greater than 125 mm (5 in.) and less than 380 mm (15 in.) wide, take full width of test fabrics and cut each specimen 380 mm (15 in.) long. Mark the length as in 6.2.1. Measurement of the width is optional.

6.2.3.2 For test specimens 25-125 mm (1-5 in.) wide, take full width of test fabrics and cut each specimen 380 mm (15 in.) long. Use only two pairs of benchmarks parallel to the length. Measurement of the width is optional.

6.2.3.3 For test specimens less than 25 mm (1 in.) in width, take full width of test fabrics and cut each specimen 380 mm (15 in.) long. Use only one pair of benchmarks parallel to the length. Measurement of the width is optional.

6.3 Original Measurements and Specimen Size.

6.3.1 Specimen size and benchmark distances used must be indicated in the report.

6.3.2 Dimensional change results may not be comparable when different specimen sizes, different benchmark lengths, different number of specimens, or different number of benchmarks are used.

6.3.3 To improve the accuracy and precision of the dimensional change calculations based on the benchmarks applied to the fabrics as instructed in 6.2, measure and record the distance between each pair of benchmarks with suitable tape or rule to nearest millimeter, eight or tenth of an inch. This is measurement A. In case of narrow fabrics less than 380 mm (15 in.) wide, measure and record width if width measurement will be used. If using a calibrated template for marking and measuring in percent dimensional change directly, an initial measurement is not needed.

7. Test Procedure

7.1 Tables I, II and III summarize alternative washing, rinsing and drying conditions and settings. Additional information on the machine and laundering conditions may be found in the monograph, *Standardization of Home Laundry Test Conditions*, elsewhere in this TECHNICAL MANUAL.

7.2 Washing.

7.2.1 Weigh test specimens and enough ballast to make a 1.8 ± 0.1 kg (4.00 ± 0.25 lb) load. An alternative load size of 3.6 ± 0.1 kg (8.00 ± 0.25 lb) may be used. Dimensional change results obtained using a 1.8 kg (4 lb) load weight may not be equal to those obtained with a 3.6 kg (8

lb) load weight and should not be compared.

7.2.2 Select the specified water level, the desired water temperature for the washing cycle and a rinse temperature of less than 29°C (85°F). If this rinse temperature is not attainable, record available rinse temperature. Fill the washing machine to the 18 ± 0.5 gal water level. For alternate load size, fill washing machine to the 22.0 ± 0.5 gal water level.

7.2.3 Add 66.0 ± 1 g of 1993 AATCC Standard Reference Detergent to an 18 ± 0.5 gal wash load. For alternative load size of 22.0 ± 0.5 gal, add 80 ± 1 g of 1993 AATCC Standard Reference Detergent. Agitate water briefly to dissolve detergent. Stop the machine agitation. It should be noted that in soft water areas, the amount of detergent used may be reduced to avoid excessive sudsing.

7.2.4 Add test specimens and ballast to machine. Set the washer for the selected washing cycle and time (see Tables I and II).

7.2.5 For specimens to be dried by procedures A, B or D, allow washing to proceed through the final spin cycle. Remove the test specimens immediately after the final spin cycle, separate tangled pieces, taking care to minimize distortion, and dry by procedure A, B or D (see Tables I and III).

7.2.6 For specimens to be dried by procedure C, Drip Dry, allow washing to proceed through to the final rinse cycle. Remove the specimens from the washer just before the water begins to drain for the final rinse cycle. Remove specimens soaking wet.

7.3 Drying.

7.3.1 For drying procedures B, C and D, do not blow air directly on specimens as it may cause fabric distortion.

7.3.2 (A) Tumble Dry. Place the washed load (test specimens and ballast) in the tumble dryer, and set the temperature control to generate the correct exhaust temperatures as specified in Table III. For fibers that are heat sensitive, lower temperatures consistent with producer's care recommendations should be used and reported. Allow the dryer to operate until the total load is dry. Remove the load immediately after the dryer stops.

7.3.3 (B) Line Dry. Hang each specimen by two corners with the fabric length in the vertical direction. Allow the test specimen to hang in still air at room temperature not greater than 26°C (78°F) until dry.

7.3.4 (C) Drip Dry. Hang each dripping wet specimen by two corners, with the fabric length in the vertical direction. Allow the specimens to hang in still air at room temperature not greater than 26°C (78°F) until dry.

7.3.5 (D) Screen Dry. Spread each

Table I—Alternative Washing and Drying Conditions (see 7.1)

Machine Cycle	Washing Temperature	Drying Procedure
(1) Normal/Cotton Sturdy	(II) $27 \pm 3^\circ\text{C}$ ($80 \pm 5^\circ\text{F}$)	(A) Tumble
(2) Delicate	(III) $41 \pm 3^\circ\text{C}$ ($105 \pm 5^\circ\text{F}$)	i. Cotton Sturdy
(3) Permanent Press	(IV) $49 \pm 3^\circ\text{C}$ ($120 \pm 5^\circ\text{F}$)	ii. Delicate
	(V) $60 \pm 3^\circ\text{C}$ ($140 \pm 5^\circ\text{F}$)	iii. Permanent Press
		(B) Line
		(C) Drip
		(D) Screen

Table II—Washing Machine Conditions Without Load (see 7.1)

	Normal	Delicate	Permanent Press
(A) Water Level	18 ± 1 gal	18 ± 1 gal	18 ± 1 gal
(B) Agitator Speed	179 ± 2 spm	119 ± 2 spm	179 ± 2 spm
(C) Washing Time	12 min	8 min	10 min
(D) Spin Speed	645 ± 15 rpm	430 ± 15 rpm	430 ± 15 rpm
(E) Final Spin Time	6 min	4 min	4 min

Table III—Dryer Setting Conditions (see 7.1)

	Cotton Sturdy	Delicate	Permanent Press
Exhaust Temperature	High $66 \pm 5^\circ\text{C}$ ($150 \pm 10^\circ\text{F}$)	Low < 60°C (140°F)	High $66 \pm 5^\circ\text{C}$ ($150 \pm 10^\circ\text{F}$)
Cool Down Time	10 min	10 min	10 min

specimen on a horizontal screen or perforated surface removing wrinkles without distorting or stretching it. Allow the specimen to dry in still air at room temperature not greater than 26°C (78°F).

7.3.6 Repeat the selected washing and drying cycle two more times or to an agreed number of cycles.

7.4 Conditioning and Restoration.

7.4.1 After the final washing and drying cycle, condition the specimens for at least 4 h (see 6.1.5) by laying each specimen separately on the screen or perforated shelves of a conditioning rack in an atmosphere of $21 \pm 1^\circ\text{C}$ ($70 \pm 2^\circ\text{F}$) and $65 \pm 2\%$ RH.

7.4.2 For fabrics that are intended to be used in a form fitting garment, restoration techniques are sometimes used prior to determining the dimensional change. Techniques for this type of restoration are not standardized (hand pulling specimens in the length and width directions at multiple locations using an unspecified force). If restoration techniques are used, a description of the technique should be reported and results should be reported as restored dimensional change.

7.4.3 If the specimens are extremely wrinkled and the consumer would ALWAYS expect to iron a garment made from the fabric, test specimens may be hand ironed prior to re-measurement of benchmarks. Use safe ironing temperatures appropriate to the fibers in the fabric being ironed. See Table I, Safe Ironing Temperature Guide, in AATCC Method 133, Colorfastness to Heat: Hot Pressing. Exert only that pressure during pressing which is necessary to remove wrinkles.

7.4.3.1 Due to the extremely high variability of hand ironing procedures performed by individual operators (no standard test method exists for hand ironing procedures), the reproducibility of dimensional change results after hand ironing has been found to be extremely poor. Consequently, caution is advised when comparing dimensional change results after laundering and hand ironing, reported by different operators.

7.4.3.2 Hand ironing is intended primarily for the evaluation of fabrics used in garments, which require ironing to remove wrinkles prior to wearing. Use safe ironing temperatures appropriate to the fibers in the fabric being ironed. See Table I, Safe Ironing Temperature Guide, in AATCC Method 133, Colorfastness to Heat: Hot Pressing. Exert only that pressure during pressing which is necessary to remove wrinkles.

7.4.3.3 After ironing, condition specimens for at least 4 h (see 6.1.5) by laying each specimen separately on the screen or perforated shelves of a conditioning rack in an atmosphere at $21 \pm 1^\circ\text{C}$ ($70 \pm 2^\circ\text{F}$) and $65 \pm 2\%$ RH.

8. Measurement

8.1 After conditioning, lay each test specimen without tension on a flat smooth, horizontal surface. Measure and record the distance between each pair of benchmarks to the nearest millimeter, eighth or tenth of an inch. This is measurement B. If using a scale calibrated in percent dimensional change, measure each benchmark to nearest 0.5% or smallest increment on the scale and record the percent dimensional change directly.

8.2 The wrinkles in most fabrics flatten sufficiently under pressure of a measuring instrument at the time of measurement not to cause measurement bias.

9. Calculation and Interpretation

9.1 Calculation.

9.1.1 If measurements were made directly in percent dimensional change, average the measurements in each direction made on the specimens after the first, third, or other specified number of washing and drying cycles. Calculate length and width averages separately to the nearest 0.1%.

9.1.2 If measurements were made to the nearest millimeter or eighth or tenth of an inch, calculate the dimensional change after the first and third or other specified washing and drying cycle as follows:

$$\text{Average\% DC} = 100 (B - A)/A$$

where:

DC = Average dimensional change

A = Average original dimension

B = Average dimension after laundering

Both the average original and average final dimensions are the averages of the measurements in each direction made on all test specimens. Calculate length and width averages separately to the nearest 0.1% (see 12.9).

9.1.3 A final measurement smaller than the original measurement results in a negative dimensional change which is shrinkage. A final measurement larger than the original measurement results in a positive dimensional change which is growth.

9.2 Interpretation.

9.2.1 If the dimensional change after one washing, drying, and, if used, hand ironing cycle as calculated in 9.1, is within a specification previously agreed on, continue test procedures as directed in 7.2, 7.3 and 7.4 until an agreed upon number of cycles has been completed.

9.2.2 If the dimensional change after one washing, drying, and, if used, hand ironing cycle as calculated in 9.1 exceeds a specification previously agreed on, terminate the test.

10. Report

10.1 Report for each sample tested:

(a) Dimensional change of length and width, separately, to the nearest 0.1% with a minus sign (-) for shrinkage or a plus (+) sign for growth (see 9.1.3).

(b) Washing procedure (include type of washing, cycle and temperature) and drying procedure (include type of drying, cycle and temperature).

(c) Size of specimens and benchmarks

(d) Size of load; i.e., 1.8 kg (4 lb) or 3.6 kg (8 lb).

(e) Number of complete washing and drying cycles (see 9.2).

(f) If fabrics were distorted or wrinkled in their original state.

(g) If fabrics were hand ironed.

(h) If fabric was restored and a restoration technique.

11. Precision and Bias

11.1 *Precision.* Precision for this test method has not been established. Until a precision statement is generated for this test method, use standard statistical techniques in making any comparisons of test results for either *within-laboratory* or *between-laboratory* averages.

11.2 *Bias.* Dimensional changes in automatic home laundering of fabrics can be defined only in terms of a test method. There is no independent method for determining the true value. As a means of estimating this property, the method has no known bias.

12. Notes

12.1 Contact AATCC, P.O. Box 12215, Research Triangle Park NC 27709; tel: 919/549-8141; fax: 919/549-8933; e-mail: orders@aatcc.org, for model number(s) and source(s) of current approved washer(s). Any other washer, which is known to give comparable results, can be used. Washing machine conditions given in Table II represent the actual speeds and times available on the current specified model(s). Other washers can vary in one or more of these settings.

12.2 Contact AATCC, P.O. Box 12215, Research Triangle Park NC 27709; tel: 919/549-8141; fax: 919/549-8933; e-mail: orders@aatcc.org, for model number(s) and source(s) of current approved dryer(s). Any other dryer, which is known to give comparable results, can be used. Dryer machine conditions given in Table III represent the actual temperatures and cool-down times available on the current specified model(s). Other dryers can vary in one or more of these settings.

12.3 Screen or perforated conditioning/drying racks available from: Somers Sheet Metal Inc., 5590 N. Church St., Greensboro NC 27405; tel: 336/643-3477; fax: 336/643-7443. Rack drawings are available from AATCC, P.O. Box 12215, Research Triangle Park NC 27709; tel: 919/549-8141; fax: 919/549-8933; e-mail: orders@aatcc.org.

12.4 Ballast are available from Testfabrics

Inc., P.O. Box 26, 415 Delaware St., W. Pittston PA 18643; tel: 570/603-0432; fax: 570/603-0433; e-mail: testfabric@aol.com; and Textile Innovators Corp., div. of SDL Atlas L.L.C., P.O. Box 8, 101 Forest St., Windsor NC; tel: 252/794-9703; fax: 252/794-9704; e-mail: tic@sdlatlas.com.

12.5 Marking pens with different size tips are available from Mark-Tex Corp., Box 681, Englewood NJ 07631; and AATCC, P.O. Box 12215, Research Triangle Park NC 27709; tel: 919/549-8141; fax: 919/549-8933; e-mail: orders@aatcc.org.

12.6 A ruled template marked in percent dimensional change is available from AATCC, Box 12215, Research Triangle Park NC 27709; tel: 919/549-8141; fax: 919/549-8933; e-mail: orders@aatcc.org. A mechanical marking device and measuring tape marked in percent dimensional change is available from The Sanforized Co., 3200 Highlands Pkwy., Suite 300, Smyrna GA 30082; tel: 770/803-7662.

12.7 A digital imaging system may be used as a measuring device in place of the pre-

scribed manual measurement devices if it is established that its accuracy is equivalent to the manual devices.

12.8 If excessive fraying occurs in laundering, specimen edges may be pinked or slashed. Sewing or over-edging a specimen is not recommended as it may influence actual dimensional change results. However, in the case where AATCC Methods 124 (Appearance of Fabrics after Repeated Home Laundering) and 135 are performed on the same specimens, some woven fabric constructions may require the specimen edges to be sewn or over-edged to prevent severe raveling that could cause entanglement in washing or drying, and therefore influence the assessment of both dimensional change and smoothness.

12.9 If information on the dimensional change variability within or between specimens is desired, calculate dimensional change based on the individual pairs of benchmarks for within specimen data or based on the average of the three pair of benchmarks for between specimen data.

12.10 Available from AATCC, P.O. Box

12215, Research Triangle Park NC 27709; tel: 919/549-8141; fax: 919/549-8933; e-mail: orders@aatcc.org

12.11 The AATCC Technical Center conducted a study to compare the 1993 AATCC Standard Reference Detergent, AATCC Standard Reference Detergent 124 and two different types of fabrics (current and proposed) to be used as ballast, under the following test conditions:

Machine cycle: (1)—Normal/Cotton
Sturdy
Washing Temp: (V)— $60 \pm 3^\circ\text{C}$ ($140 \pm 5^\circ\text{F}$)
Drying Procedure: (A)i—Tumble dry, cotton
sturdy cycle
Fabrics tested: White Twill (100% cotton)
Beige Twill (100% cotton)
Grey Poplin (100% cotton)
Blue Twill (50/50 poly/
cotton)

No significant differences were found in the results using either detergent or ballast load fabrics.

Bond Strength of Bonded and Laminated Fabrics

Developed in 1972 by AATCC Committee RA79; editorially revised and reaffirmed 1980, 1985, 1995; editorially revised 1988, 1990, 1997; reaffirmed 1989; revised 2003.

1. Purpose and Scope

1.1 This test method provides a procedure for characterizing bond strength of bonded and laminated fabrics. Bond strength tests can be made on the fabric as bonded or laminated or after a specified number of drycleaning and/or laundering cycles.

2. Principle

2.1 Bond strength tests can be made on the fabric as bonded or laminated and subsequently drycleaned, or laundered and dried, or both, through a prescribed cycle that is repeated a specified number of times. The drycleaned or washed specimens are tested to determine the strength of the bond.

3. Terminology

3.1 **bond strength**, n.—*in bonded and laminated fabrics*, the tensile force expressed in g/cm (oz/in.) of width required to separate the component layers under specified conditions.

3.2 **bonded fabric**, n.—a layered fabric structure wherein a face or shell fabric is joined to a backing fabric with an adhesive that does not significantly add to the thickness of the combined fabrics.

NOTE 1: In this context, a thin layer of foam is considered an adhesive when the cell structure is completely collapsed by a flame.

NOTE 2: Normally, but not always, the backing fabric may be tricot or non-woven.

3.3 **foam tear**, n.—*in laminated fabrics*, a condition wherein the foam portion of the fabric ruptures prior to the failure of the bond.

3.4 **laminated fabric**, n.—a layered fabric structure wherein a face or outer fabric is joined to a continuous sheet material in such a way that the identity of the continuous sheet material is retained.

NOTE 1: Either the flame or adhesive method of laminating can be used.

NOTE 2: Normally, but not always, the sheet material is joined to a backing fabric.

NOTE 3: Normally, but not always, the backing fabric may be tricot or non-

woven, and the sheet material may be polyurethane.

3.5 **lot**, n.—*in bonded or laminated fabric*, a single run on the bonding or laminating machine in which the processing is carried out without stopping or changing processing conditions and consisting of either a single dye lot or a single greige goods lot.

4. Safety Precautions

NOTE: These safety precautions are for information purposes only. The precautions are ancillary to the testing procedure and are not intended to be all inclusive. It is the user's responsibility to use safe and proper techniques in handling materials in this test method. Manufacturers MUST be consulted for specific details such as material safety data sheets and other manufacturer's recommendations. All OSHA standards and rules must also be consulted and followed.

4.1 Good laboratory practice should be followed. Wear safety glasses in all laboratory areas.

4.2 All chemicals should be handled with care.

4.3 Perchloroethylene is toxic by inhalation, by repeated contact with the skin and by ingestion; it should be used only in a well-vented atmosphere. Toxicology studies with laboratory animals have shown evidence of cancer in rats and mice exposed to perchloroethylene vapors at 100-400 ppm concentrations for prolonged times. Fabric saturated with this solvent should be dried in an adequately ventilated hood. Use chemical goggles or face shield, impervious gloves and an impervious apron when handling perchloroethylene.

4.4 An eyewash/safety shower should be located nearby and an organic vapor respirator should be readily available for emergency use.

4.5 The drycleaning apparatus should be ventilated to the outside atmosphere in accordance with the manufacturers instructions.

4.6 Manufacturer's safety recommendations should be followed when operating laboratory testing equipment.

4.7 Exposure to chemicals used in this procedure must be controlled at or below levels set by governmental authorities (e.g., Occupational Safety and Health Administration's [OSHA] permissible exposure limits [PEL] as found in 29 CFR 1910.1000 of January 1, 1989). In addition, the American Conference of

Governmental Industrial Hygienists (ACGIH) Threshold Limit Values (TLVs) comprised of time weighted averages (TLV-TWA), short term exposure limits (TLV-STEL) and ceiling limits (TLV-C) are recommended as a general guide for air contaminant exposure which should be met (see 14.1).

5. Uses and Limitations

5.1 This test method is used to estimate the durability and strength of the bond that may be expected when the garments made from bonded and laminated fabrics are laundered or drycleaned.

6. Apparatus and Materials

6.1 Drycleaning machine, single-unit, coin-operated type, capable of providing a complete automatic dry-to-dry cycle using perchloroethylene (see 14.7). Reference AATCC Method 158, Dimensional Changes on Drycleaning in Perchloroethylene: Machine Method.

6.2 Drycleaning tester, stainless steel cylinder which rotates on an axis 50' off center (see 14.3).

6.3 Domestic automatic washer, top loading, spin-extracting type (see 14.4).

6.4 Domestic automatic tumble dryer, front loading type (see 14.4).

6.5 Press, flat bed, steam, a flat bed press, approximately 60 × 127 cm (24 × 50 in.), or larger, provided with 413-482 kPa (60-70 psig) steam pressure at the press. Any flat bed press large enough for pressing a specimen 38 cm (15 in.) square may be used (see 14.5).

6.6 Tensile testing machine, constant rate of traverse type or constant rate of extension type, equipped with 76 mm (3 in.) clamps and preferably calibrated in kilograms and conforming to ASTM D 76, Standard Specification for Tensile Testing Machines for Textiles (see 14.6 and 14.7).

6.7 Detergent, home laundry type (see 14.8).

6.8 Perchloroethylene, commercial grade (see 4.3).

6.9 Drycleaning detergent (see 14.9), petroleum sulfonate type.

6.10 Templates, 25 × 152 mm (1 × 6 in.) or 76 × 152 mm (3 × 6 in.).

7. Selection and Number of Samples

7.1 In the absence of any applicable material specifications, take at random one 1 m long (1.1 yd long), full width sample from each lot to be tested. If the

lot consists of more than two pieces, take the samples from other than the first or last piece. If the lot consists of two pieces, take samples from each piece, adjacent to the place where the two pieces are joined. In any case, do not take samples closer than approximately 0.5 m (19.7 in.) from either end each piece.

7.2 If the fabric sample is of such size not permitting full lot sampling, other sampling procedures may be used.

8. Conditioning

8.1 Samples from which specimens are to be taken to determine dry bond strength are conditioned for at least 4 h in the standard atmosphere for testing textiles as described in ASTM D 1776, Standard Practice for Conditioning and Testing Textiles (see 14.7).

9. Preparation and Number of Test Specimens

9.1 Test Conditions.

9.1.1 Bond strength tests may be made on the fabric as bonded or laminated, or after a specified number of drycleaning cycles or after a specified number of laundering cycles. These tests also may be made on dry specimens (conditioned in the standard atmosphere for testing textile for a minimum of 4 h), or on wet specimens, saturated with water at room temperature following laundering.

9.2 Laundering and Drycleaning Specimens.

9.2.1 From each sample cut four specimens, two located approximately one-third the distance of the width of the fabric from one side and two located approximately one-third the distance of the width of the fabric from the other side, each specimen 38 × 38 cm (15 × 15 in.). Use a specimen from each side of the fabric for drycleaning and a specimen from each side of the fabric for laundering.

9.3 Bond Strength Test Specimens.

9.3.1 Prepare three test specimens, each measuring either 25 mm (1 in.) wide, and 152 mm (6 in.) long or 76 mm (3 in.) wide, and 152 mm (6 in.) long, the length of the specimens corresponding to the length direction of the fabric for each condition to be tested. Do not take the test specimens closer to the selvage than the distance equal to 20% of the fabric width.

10. Drycleaning and Laundering

10.1 Procedure for Drycleaning.

10.1.1 Coin-operated type machine. Follow procedure described in ASTM D 2724, Standard Test Method for Bonded, Fused and Laminated Apparel Fabrics, for the required number of cycles (see 14.7).

10.1.2 Drycleaning Cylinder. Follow

procedure described in AATCC Method 158 for the required number of cycles.

10.2 Procedure for Laundering. Follow procedure described in AATCC Method 124, Appearance of Fabrics after Repeated Home Laundering, for the required number of cycles.

11. Strength of Bond

11.1 Test Conditions. Bond strength tests may be made on the fabric as bonded or laminated, or after the specified number of drycleaning or laundering cycles. These tests also may be made on dry specimens (conditioned in the standard atmosphere for testing textiles for a minimum of 4 h), or on wet specimens saturated with water at room temperature following the laundering tests (see Section 4).

11.1.1 An optional procedure would be to test washed but undried specimens.

11.2 Procedure for Bonded Fabrics.

11.2.1 Manually separate the two layers of fabric along the narrow width of each test specimen for a distance approximately 25 mm (1 in.) in the direction of the specimen length.

11.2.2 Set the lower clamp at a distance of 25 mm (1 in.) from the upper clamp of the tensile testing machine in such a way that the longitudinal axis of the specimen forms a right angle with the closed clamping surface. Secure the separated backing fabric in the center of the lower clamp of the machine in such a way that the longitudinal axis of the specimen forms a right angle with the closed jaws of the lower clamp.

11.2.3 If the indicating scale in the machine is provided with a pawl and ratchet mechanism, disengage the mechanism to permit readings of variable force when the machine is placed in operation.

11.2.4 Operate the constant rate-of-traverse machine at a pulling speed of 305 ± 13.0 mm/min (12 ± 0.5 in./min).

11.2.5 Operate the constant rate-of-extension machine per procedure described in ASTM D 76.

11.2.6 Record the average bond strength in grams per 25 mm (ounces per 1 in.) registered for 102 mm (4 in.) of delamination from direct readout instruments. Determine the average of at least the five highest and the five lowest peak loads of resistance per 25 mm (1 in.), registered for 102 mm (4 in.) of delamination when reading peel strength from a chart recorder.

11.2.7 Repeat the operations described in 11.2.1-11.2.6 for each of the remaining test specimens.

11.2.8 Report the bond strength in g/cm (oz/in.) as the average strength of the three test specimens.

11.3 Procedure for Laminated Fabrics, Foam.

11.3.1 Manually separate the face fabric from the foam along the narrow width of each test specimen for a distance of approximately 25 mm (1 in.) in the direction of the specimen length.

11.3.2 Set the lower clamp at a distance of 25 mm (1 in.) from the upper clamp. Secure the separated face fabric of a test specimen in the upper clamp of the tensile testing machine in such a way that the longitudinal axis of the specimen forms a right angle with the closed clamping surface. Secure the separated foam or foam and backing fabric in the center of the lower clamp of the machine in such a way that the longitudinal axis of the specimen forms a right angle with the closed jaws of the lower clamp.

11.3.3 Proceed as instructed in 11.2.3-11.2.8.

11.3.4 If foam is laminated to a backing fabric, retain each test specimen from 11.3.3 after the bond strength has been determined for face to foam. Manually separate the backing fabric from the foam as instructed in 11.3.1 except that the manual separation should be made at the opposite end of the test specimen separated for the face fabric-to-foam test.

11.3.5 Set the lower clamps at a distance of 25 mm (1 in.) from the upper clamp. Secure the separated foam or foam and face fabric of a test specimen in the upper clamp of the tensile testing machine in such a way that the longitudinal axis of the specimen forms a right angle with the closed clamping surface. Secure the separated backing fabric in the lower clamp of the machine in such a way that the longitudinal axis of the specimen forms a right angle with the closed jaws of the lower clamp.

11.3.6 Proceed as instructed in 11.2.3-11.2.8.

11.3.7 Examine both sides of the foam on the test specimens after testing for bond strength. Determine whether the foam portion ruptured during peeling allowing any foam to adhere to either fabric surface. If this has occurred, make the notation "foam tear" for that test specimen for the side or sides where foam tear occurred. If foam tear occurs only on one side of one test specimen, disregard this result and report the average bond strength for that side of the remaining two specimens. If foam tear occurs on the same side of two or three specimens, report the bond strength for that side as foam tear.

11.3.8 In the event it is impossible to separate manually the foam from either the face or the backing fabric as instructed in 11.3.1 and 11.3.4 without rupturing the foam, report the bond strength for the side or sides where this occurred as foam tear.

12. Report

12.1 State that the tests were made as directed in AATCC Method 136.

12.2 Report the following information:

12.2.1 Test specimen size and number. Sampling procedure if not as stated in 7.1.

12.2.2 Test conditions under which the tests were run on the fabric as bonded or laminated or after laundering or drycleaning, and the laundering or drycleaning procedures used. Reference AATCC Monograph on *Standardization of Home Laundry Test Conditions for Laundering* and AATCC Method 158 for drycleaning. [Note: the alternate drycleaning method (see 10.1.2) may yield different results from the coin-op procedure (see 10.1.1).]

12.2.3 The number of drycleaning or laundering cycles performed prior to testing.

12.2.4 Condition of the specimens as dry or wet for the tests performed as described in 11.1.

12.3 The bond strength in g/cm (oz/in.) as specified in Section 11.

12.4 If tear in case of foam laminated fabrics was a foam tear.

13. Precision and Bias

13.1 *Precision.*

13.1.1 The precision statement for bond strength of bonded and laminated fabrics is based on statistical analysis of bond strength measurements of two fabrics by six laboratories. Each laboratory received 20 specimens of each fabric to test 10 one day and 10 the next. The specimens were prepared by one laboratory and randomized before sending for testing. The test results used for statistical analysis using ASTM E 691, Standard Practice for Interlaboratory Study of Precision Procedure. There was no statistical comparison between day one and day two. Instead, each set of fabrics was treated as a separate material. Using this approach, the number of laboratories, materials, and determinations in this study does meet the minimum requirements for determining precision prescribed in ASTM E 691. Four of the laboratories used the older method to determine bond strength and two of the labs used newer, direct read equipment. No effort was made to determine if there was a difference between the two methods as the number of laboratories was not equal. There was no obvious difference between the two methods of gathering data. The precision statement for AATCC Method 136, Bond Strength of Bonded and Laminated Fabrics, is found in Table I:

Table I—Bond Strength Variance (grams/inch)

Material:	1	2	3	4
Average:	209	199	660	615
Repeatability:				
Sr	22	24	77	72
r	61	67	214	201
Reproducibility:				
SR	26	27	85	76
R	71	77	238	212

Sr = Repeatability Standard Deviation

SR = Reproducibility Standard Deviation

r = 95% Repeatability

R = 95% Reproducibility

The average repeatability (*within-laboratory*) for the laminated fabrics was 32% of average bond strength. The average reproducibility (*between-laboratories*) was slightly higher, 36% of average bond strength.

13.2 *Bias.* The bond strength of bonded and laminated fabrics can be defined only in terms of a test method. There is no independent method for determining a true value. As means of determining this property, the method has no known bias.

14. Notes

14.1 Available from Publications Office, ACGIH, Kemper Woods Center, 1330 Kemper Meadow Dr., Cincinnati OH 45240; tel: 513/742-2020.

14.2 Suitable equipment is available from Marvel Manufacturing Co., 5922 San Pedro, San Antonio TX 78212; tel: 800/487-1326.

14.3 Model 6523, available from SGS U.S. Testing Co., 291 Fairfield Ave., Fairfield NJ 07704; tel: 973/575-5252 or 800/777-8378, is satisfactory for this purpose.

14.4 Contact AATCC, P.O. Box 12215, Research Triangle Park NC 27709; tel: 919/ 439-8141; fax: 919/549-8933; e-mail: orders@aatcc.org, for model number(s) and source(s) of approved washer(s) and dryer(s). Any other washer or dryer, which is known to give comparable results, may be used.

14.5 Suitable pressing equipment of the type described may be obtained as New Yorker Flat Bed Press Model ES 24 × 48 or Model ES 24 × 60 from Hoffman New Yorker, 25 Lackawanna Pl., Bloomfield NJ 07703; tel: 201/748-0500.

14.6 Scott Tester Model X-5, available from Physical Testing Equipment Services Inc., P.O. Box 19108, Johnston RI 02919; tel: 401/944-4760; fax: 401/944-4960, has been found satisfactory.

14.7 Book of ASTM Standards, available from ASTM, 100 Barr Harbor Dr., West Conshohocken PA 19428; tel: 610/832-9500; fax: 610/832-9555.

14.8 1993 AATCC Standard Reference Detergent is suitable and is available from AATCC, P.O. Box 12215, Research Triangle Park NC 27709; tel: 919/549-8141; fax: 919/549-8933; e-mail: orders@aatcc.org.

14.9 Codusol is an acceptable drycleaning detergent. For the name of an area distributor contact R. R. Street & Co., 184 Shuman Blvd., Naperville IL 60563; tel: 708/416-4244.

Rug Back Staining on Vinyl Tile

Developed in 1972 by AATCC Committee RA57; reaffirmed 1973, 1989, 2000; editorially revised 1974, 1986, 1991, 2001; revised 1983, 2002; editorially revised and reaffirmed 1995.

1. Purpose and Scope

1.1 This test method determines the degree of color transferred from the back or face surface of colored rugs to vinyl tile.

1.2 The wet testing in this method is a means of acceleration and has been found to correlate with both dry and wet in-service use.

2. Principle

2.1 A rug specimen is wet out and placed between two pieces of tile and subjected to a weighted load for 24 h at room temperature.

2.2 Color transferred to the tile is assessed by a comparison with the AATCC Chromatic Transference Scale or Gray Scale for Staining.

3. Terminology

3.1 **colorant staining**, n.—the unintended pickup of colorant by a substrate due to (1) exposure to a colored or contaminated liquid medium, or (2) direct contact with dyed or pigmented material, from which colorant transfers by sublimation or mechanical action (as in crocking).

3.2 **rug**, n.—a textile floor covering of limited area which is complete in itself and is intended for use as a partial covering of a floor or another floor covering.

3.3 **rug back**, n.—(1) that part of a rug normally in contact with the floor; (2) the underside of a rug as opposed to the use surface.

4. Safety Precautions

NOTE: These safety precautions are for information purposes only. The precautions are ancillary to the testing procedures and are not intended to be all inclusive. It is the user's responsibility to use safe and proper techniques in handling materials in this test method. Manufacturers MUST be consulted for specific details such as material safety data sheets and other manufacturer's recommendations. All OSHA standards and rules must also be consulted and followed.

4.1 Good laboratory practices should be followed. Wear safety glasses in all

laboratory areas.

4.2 Observe wringer safety, especially at the nip point. The safety recommendations provided by the wringer manufacturer should be followed.

5. Apparatus and Materials

5.1 Two 76 × 76 mm (3 × 3 in.) 100% vinyl tiles, solid white and smooth surfaced (see 11.1).

5.2 Laboratory wringer.

5.3 Weight, with mass of 0.91 kg (2.0 lb) (see 11.2).

5.4 Rating Scales.

5.4.1 AATCC Chromatic Transference Scale (see 11.3).

5.4.2 Gray Scale for Staining (see 11.3).

5.5 Distilled water.

5.6 AATCC Detergent #171 (see 11.5).

6. Test Specimens

6.1 A 51 × 51 mm (2 × 2 in.) specimen is cut from a representative sample of the rug, binding tape or fringe. It is recommended that rugs having multiple colors or fibers be tested in areas representative of each.

7. Procedure

7.1 Prewash tile with AATCC Detergent #171 prepared according to the directions supplied (see 11.5.1). Dry with toweling.

7.2 Completely wet out the test specimen with distilled water.

7.3 Pass the test specimen between squeeze rolls (wringer) such that a pickup of 40-60% is obtained.

7.4 Place the rug specimen back side down on the face side of one of the tiles.

7.5 Cover the test specimen with the other tile, face side down on rug face pile.

7.6 Apply a 0.91 kg (2.0 lb) mass to sandwiched test assembly (see 11.2).

7.7 Allow test assembly to remain fixed for 24 h at room temperature.

7.8 Do not permit movement of rug specimen or tile after applying weight as it can affect test results.

7.9 Remove weight and rug specimen and let tiles condition at room temperature face up for 30 min.

7.10 Wash tile with AATCC Detergent #171 solution. Dry with toweling.

8. Evaluation

8.1 Evaluate the degree of color transferred from the rug backing or face fiber on to the face of the vinyl tile by means

of AATCC Chromatic Transference Scale or the Gray Scale for Staining (see 11.3).

8.1.1 Where fringe or binding tape is a factor, color transference to the vinyl tile can also be evaluated from the tile which was used as the cover in the test assembly.

8.2 Evaluate the color transfer at the most severe area on the tile.

8.3 Rate staining on vinyl tile as follows:

Grade 5—negligible or no color transfer.

Grade 4.5—color transfer equivalent to Step 4-5 on the Gray Scale for Staining or Row 4.5 on the 9-step AATCC Chromatic Transference Scale.

Grade 4—color transfer equivalent to Step 4 on the Gray Scale for Staining or Row 4 on the 9-step AATCC Chromatic Transference Scale.

Grade 3.5—color transfer equivalent to Step 3-4 on the Gray Scale for Staining or Row 3.5 on the 9-step AATCC Chromatic Transference Scale.

Grade 3—color transfer equivalent to Step 3 on the Gray Scale for Staining or Row 3 on the 9-step AATCC Chromatic Transference Scale.

Grade 2.5—color transfer equivalent to Step 2-3 on the Gray Scale for Staining or Row 2.5 on the 9-step AATCC Chromatic Transference Scale.

Grade 2—color transfer equivalent to Step 2 on the Gray Scale for Staining or Row 2 on the 9-step AATCC Chromatic Transference Scale.

Grade 1.5—color transfer equivalent to Step 1-2 on the Gray Scale for Staining or Row 1.5 on the 9-step AATCC Chromatic Transference Scale.

Grade 1—color transfer equivalent to Step 1 on the Gray Scale for Staining or Row 1 on the 9-step AATCC Chromatic Transference Scale.

9. Report

9.1 Report the grade determined in 8.3.

9.2 Report the color transference determined for rug back and face. As an option, the color transference may be reported for fringe or binding tape.

9.3 Report whether Gray Scale for Staining or Chromatic Transference Scale was used for evaluating staining (see 11.4).

10. Precision and Bias

10.1 *Precision*. A preliminary intra-laboratory study was run in 1999 with a single laboratory with four materials, with a total of eight test results for each material. Refer to Table I for *within-laboratory* precision.

Table I—Summary of Precision Parameters

Material*	Observations Each Average	Overall Average	Repeatability Standard Deviation (<i>within-laboratory</i>)	95% Repeatability Limit (<i>within-laboratory</i>)
A	8	3.4	0.42	0.35
B	8	4.1	0.35	0.30
C	8	3.4	0.32	0.27
D	8	2.9	0.32	0.27

*Material A-Tan Cotton Rug; Material B-Pink Cotton Rug; Material C-Blue Nylon Rug; Material D-Red Nylon Rug

10.2 *Bias*. Rug back staining, on vinyl tile, can be defined only in terms of a test method. There is no independent method for determining the true value. As a means of estimating this property, the method has no known bias.

11. Notes

11.1 AATCC Standard Vinyl Tile 137-2 available from AATCC, P.O. Box 12215, Research Triangle Park NC 27709; tel: 919/549-8141; fax: 919/549-8933; e-mail: orders@aatcc.org.

11.2 A laboratory beaker filled with sufficient water is satisfactory.

11.3 Available from AATCC, P.O. Box 12215, Research Triangle Park NC 27709; tel: 919/549-8141; fax: 919/549-8933; e-mail: orders@aatcc.org.

11.4 It has been noted that different ratings may result depending upon whether the Gray Scale for Staining or AATCC Chromatic Transference Scale is used for the evaluation. It is, therefore, important to report which scale was used.

11.5 AATCC Detergent #171 available from AATCC, P.O. Box 12215, Research Triangle Park NC 27709; tel: 919/549-8141; fax: 919/549-8933; e-mail: orders@aatcc.org.

11.5.1 Dilution: 3.0-4.5 g/L.

11.5.2 Contents of detergent:

- (a) Sodium metasilicate pentahydrate
- (b) Sodium stearate
- (c) Dodecylbenzene sulfonate
- (d) Sodium bicarbonate
- (e) Sodium tripolyphosphate

Cleaning: Washing of Textile Floor Coverings

Developed in 1972 by AATCC Committee RA57 (as shampooing procedure); revised 1978, 1982, 1995 (to cleaning procedure with title change), 2000; editorially revised 1986, 1998; editorially revised and reaffirmed 1987; reaffirmed 2005.

1. Purpose and Scope

1.1 This test method is a laboratory procedure designed to simulate changes that occur in washing of a textile floor covering during cleaning.

1.2 This method is recommended only for small specimens with dimensions not exceeding the capacity of commercially-available laboratory equipment.

1.3 This test method may be used on soiled, as well as unsoiled, textile floor coverings.

1.4 This wet cleaning procedure can be used for the evaluation of:

- wetfastness durability and permanency of antimicrobial properties
- colorfastness behavior
- permanency of finishes and other topical treatments to the pile of textile floor coverings before, during or after manufacturing
- cleanability
- dimensional stability

1.5 This procedure may also be used for the removal of soil or extraneous matter from specimens of textile floor coverings to prepare them for testing.

2. Principle

2.1 A specimen is washed by hand scrubbing using a surfactant cleaning agent solution, rinsed and dried.

3. Terminology

3.1 **carpet**, n.—all textile floor coverings not designated as rugs.

3.2 **textile floor covering**, n.—an article having a use-surface composed of textile material and generally used for covering floors.

3.3 **use-surface**, n.—of *textile floor covering*, the part of a textile floor covering directly exposed to foot traffic.

3.4 **washing**, n.—in *testing textile floor coverings*, a specific wet cleaning process involving the use of detergent and scrub brush to remove soil and/or extraneous matter residing in the pile fibers.

4. Safety Precautions

NOTE: These safety precautions are for information purposes only. The precautions are ancillary to the testing procedures and are not intended to be all inclusive. It is the user's responsibility to use safe and proper techniques in handling materials in this test method. Manufacturers MUST be consulted for specific details such as material safety data sheets and other manufacturer's recommendations. All OSHA standards and rules must also be consulted and followed.

4.1 Good laboratory practices should be followed. Wear safety glasses in all laboratory areas.

4.2 All chemicals should be handled with care.

4.3 Eye protection should be used when mixing, handling or applying the detergent and detergent solutions.

4.4 Gloves or protective hand cream are recommended for handling detergents and solutions.

4.5 Observe operating procedures and precautions by the manufacturer of the extraction machine. Liquid under pressure and high vacuum, can cause excessive splashing of liquids and/or hose "kick back."

4.6 Special care should be used at the nip point of the wringer. Follow the safety guidelines of the manufacturer.

5. Apparatus and Materials

5.1 **Cleaning Agent**: Sodium lauryl sulfate type of surfactant (see 10.1). AATCC Standard Detergent (see AATCC Method 171) can be used. A 1.0% solution of this surfactant should have a pH of 8.0 ± 0.5 .

5.2 **Scrub Brush**: A brush with stiff nylon or polypropylene bristles (see 10.2) approximately 25 mm long. The width of the brush should be approximately 50 mm; the length preferably no less than one dimensional length of the test specimen, 200 mm.

5.3 **Extraction Unit**: A laboratory wringer (see 10.3), padder or hydro-extractor.

5.4 **Drying Unit**: Circulating air-type oven recommended.

6. Test Specimens

6.1 Textile floor covering samples, finished with back coating, approximately 200×200 mm square.

7. Procedure

7.1 Thoroughly wet out each specimen by soaking for 1 min in clean, tap water at $50 \pm 3^\circ\text{C}$. Extract excess water by passing through a laboratory wringer or hydro-extractor.

7.2 Secure the specimen to the floor by a suitable means (double-stick tape) or use the scrub block (see Fig. 1) to secure during the hand scrubbing process.

7.3 For every 645 mm^2 of pile surface, apply 0.30 mL of the 1.0% solution of sodium lauryl sulfate preheated to $50 \pm 3^\circ\text{C}$ to the face fibers. For example, a 200×200 mm specimen would require approximately 20 mL of this cleaning solution. Hand scrub *the entire surface of the pile* in specimen with the scrub brush, using 5 full strokes in each direction. A full stroke implies motion forward and backward in this case. Scrub 5 strokes along one dimension and repeat with 5 strokes across the specimen.

7.4 Thoroughly rinse each specimen with clean tap water at $50 \pm 3^\circ\text{C}$. Remove excess water by squeezing through a lab wringer or hydro-extracting.

7.5 Place each specimen in the oven (see 5.4) set at $105 \pm 5^\circ\text{C}$. Do not remove specimen until dry.

7.6 Cool down the specimen after drying before test work is allowed to proceed. Conditioning at standard laboratory temperature and relative humidity is recommended. Also, a Scrub Block can be used to secure the specimens during the hand scrubbing process (see 10.4 and Fig. 1).

8. Evaluation

8.1 This is a washing procedure which is not evaluated.

8.1.1 Specimens cleaned according to this procedure are suitable substrates for evaluating the effect of washing on colorfastness, cleanability, dimensional change and the durability of finishes, topicals and antimicrobial treatments. State that the test specimens were cleaned according to AATCC Method 138. Report the number of wash cycles (see 7.1, 7.2, 7.3 and 7.4) performed.

9. Precision and Bias

9.1 Precision and Bias statements are not applicable because data are not generated by this test method.

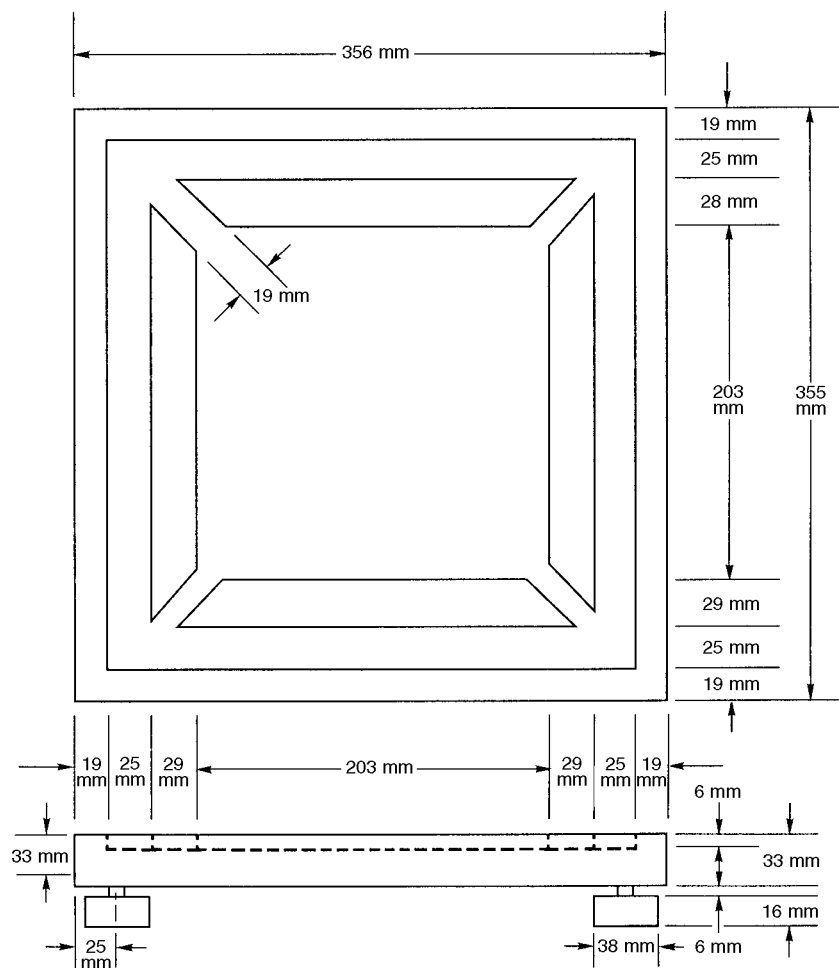
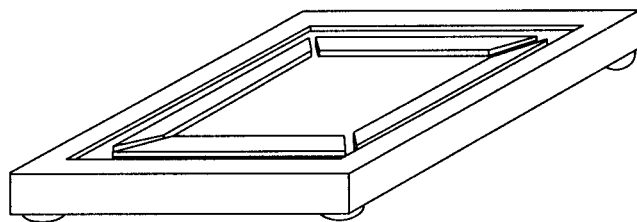

Fig. 1—Scrub block.

10. Notes

10.1 AATCC Standard Detergent 171 can be used. Other suitable cleaning agents are sodium lauryl sulfate type of surfactant. Duponol WA Paste is available from Witco Corp., Organics Division, 520 Madison Ave., New York NY 10022; tel: 212/755-4593. Another supplier of this type of surfactant is Stepan Co., 22W Frontage Rd., Northfield IL 60093; tel: 708/446-7500 or 800/745-7837.

10.2 Pantry Scrub Brush. Manufactured by Empire Brushes Inc., Hwy. 13, Greenville NC 27835; tel: 919/758-4111. Sold at Wal-Mart Stores, Stock Item #76-4119. Atlanta Brush Co., P.O. Box 2852, Atlanta GA 30301. Supplier of Scrub Brush #AB-4558.

10.3 The Atlas Motorized Laboratory Wringer and Padder Attachment is suitable. This equipment is available from SDL Atlas L.L.C., 1813A Associate Lane, Charlotte NC 28217; tel: 704/329-0911; fax: 704/329-0914; e-mail: info@sdlatlas.com. Alternatively a hand-operated wringer can be used.

10.4 Some laboratories rely on special jigs to hold the 200 × 200 mm square specimen in place during the scrubbing process. A schematic of a Scrub Block designed to hold carpet specimens during the scrubbing process is included as Fig. 1.

Colorfastness to Light: Detection of Photochromism

Developed in 1972 by AATCC Committee RA50; supersedes AATCC 32-1952; reaffirmed 1975, 1980, 2000, 2005; editorially revised 1981, 1988, 2004; editorially revised and reaffirmed 1985, 1989, 1995. Technically equivalent to ISO 105-B05.

1. Purpose and Scope

1.1 This test method is intended for detecting and assessing colored textiles which change in color after brief exposure to light but which return to their original shade when stored in the dark.

2. Principle

2.1 A specimen is exposed to light of high intensity for a time much shorter than that necessary to cause a permanent change. The change in color of the specimen is assessed immediately after exposure with the Gray Scale for Color Change. The specimen is then stored in the dark under specified conditions and assessed again.

3. Terminology

3.1 **colorfastness**, n.—the resistance of a material to change in any of its color characteristics, to transfer of its colorant(s) to adjacent materials or both, as a result of the exposure of the material to any environment that might be encountered during the processing, testing, storage or use of the material.

3.2 **photochromism**, n.—a qualitative designation for a reversible change in color of any kind (whether a change in hue or chroma) which is immediately noticeable upon termination of light exposure when the exposed area of a specimen is compared to the unexposed area.

NOTE: The reversion of the color change or instability of the hue or chroma upon standing in the dark distinguishes photochromism from fading.

4. Safety Precautions

NOTE: These safety precautions are for information purposes only. The precautions are ancillary to the testing procedures and are not intended to be all inclusive. It is the user's responsibility to use safe and proper techniques in handling materials in this test method. Manufacturers MUST be consulted for specific details such as material safety data sheets and other manufacturer's recommendations. All OSHA standards and rules

must also be consulted and followed.

4.1 Do not operate the test equipment until the manufacturer's instructions have been read and understood. It is the operator's responsibility to conform to the manufacturer's directions for safe operation.

4.2 The test equipment contains high intensity light sources. Do not look directly at the light source. The door to the test chamber must be kept closed when the equipment is in operation.

4.3 Before servicing light sources, allow 30 min for cool-down after lamp operation is terminated.

4.4 When servicing the test equipment, shut off both the off switch on the front panel and the main power disconnect switch. When equipped, ensure that the main power indicator light on the machine front panel goes out.

4.5 Daylight exposure of skin and eyes for prolonged periods may be hazardous and, therefore, caution should be employed to protect these areas. Do not look directly at the sun under any circumstances.

4.6 Good laboratory practices should be followed. Wear safety glasses in all laboratory areas.

5. Apparatus and Materials

5.1 AATCC Blue Wool Standard L2 used in the methods for determining colorfastness to light (see 10.1).

5.2 A fading apparatus is described in AATCC Method 16, Colorfastness to Light.

5.3 A suitable opaque mask such as the metal holder, opaque paper mask or black paper mask (see 10.2).

5.4 Black paper such as the inside of the paper mask (see 10.2).

5.5 Gray Scale for Color Change (see 10.1).

6. Specimen

6.1 An area of textile not less than 60 × 30 mm (2.4 × 1.2 in.) is required. The specimen may be a strip of cloth or yarn, either wound close together on a card or laid parallel and fastened on a card.

6.2 To facilitate handling, the specimen and a similar strip of the standard may be mounted on separate cards.

7. Procedure

7.1 Calibrate the fading apparatus by exposing the Blue Wool Standard L2 as directed in AATCC Method 16. Cover

one-half of the strip of standard with the opaque mask. The paper mask must be placed in the holder such that the black portion of the mask is facing the lamp.

7.2 Expose the partially covered standard in the fading apparatus under the same conditions recommended in AATCC Method 16 until the contrast between the original and the exposed portion of the standard is equal to Step 4 on the Gray Scale. This sample should be exposed continuously (see 10.3). Determine the time necessary to produce this change.

7.3 Cover one-half of the specimen with the opaque mask and expose it in the same position and under the same conditions as in 7.2 for one twenty-fifth of the time or radiant energy necessary to produce a detectable fade on Standard L2.

7.4 Remove the specimen from the source of light; immediately remove the cover from the specimen and assess the contrast between the original and the exposed portions with the Gray Scale.

7.4.1 If the contrast is equal to or less than Step 4 of the Gray Scale, the specimen is not photochromic and further examination is not necessary.

7.4.2 If the contrast between the original and the exposed portion of the specimen is greater than Step 4 of the Gray Scale, leave the specimen in the dark for 1 h at 21 ± 1°C (70 ± 2°F) and relative humidity of 65 ± 2%.

7.4.2.1 If the contrast has not fully disappeared in 1 h, expose the sample to steam at atmospheric pressure for 15 s in an attempt to accelerate any further recovery of the shade which might occur in a longer period of recovery.

7.5 Inspect the specimen to determine if the contrast between the covered control and exposed portion is still visible and if so reassess the contrast between the original and exposed portions of the specimens against the Gray Scale.

7.6 Assess the fastness to light in a parallel test using AATCC Method 16, Section 26.

8. Interpretation and Report

8.1 If the specimen immediately shows a contrast equal to or less than Step 4 of the Gray Scale between the exposed portion and the original immediately after exposure, the specimen is not photochromic. Report the lightfastness of the specimen in the normal manner.

8.2 If the sample immediately after exposure shows a contrast between the original and the exposed specimen which

is greater than Gray Scale Step 4 but which after conditioning according to 7.4.2 shows a difference no greater than Gray Scale Step 4-5, report the specimen as being photochromic.

8.3 If the contrast between the original and the exposed portion of the specimen after conditioning for 1 h in the dark is greater than Step 4 of the Gray Scale, the sample is not photochromic but of low initial lightfastness. Assess the grade for the first perceptible change given in parentheses.

8.4 The lightfastness rating of the specimen must be followed by the letter "P," and the Gray Scale grade in parentheses (see 10.4); e.g., 6 (P4) or 6-7 (P2-3) (see 10.5).

8.5 Report details of exposure using the form titled "Typical Exposure Control and Report Form" found in Table V of AATCC Method 16.

9. Precision and Bias

9.1 *Precision.* Precision for this test method has not been established. Until a precision statement is generated for this

test method, use standard statistical techniques in making any comparisons of test results for either *within-laboratory* or *between-laboratory* averages.

9.2 *Bias.* Detection of photochromism (colorfastness to light) can be defined only in terms of a test method. There is no independent method for determining true value. As a means of estimating this property, the method has no known bias.

10. Notes

10.1 Available from AATCC, P.O. Box 12215, Research Triangle Park NC 27709; tel: 919/549-8141; fax: 919/549-8933; e-mail: orders@aatcc.org.

10.2 Available from SDL Atlas L.L.C., 1813A Associate Lane, Charlotte NC 28217; tel: 704/329-0911; fax: 704/329-0914; e-mail: info@sdlatlas.com.

10.3 In a fading apparatus which rotates each specimen frame, the specimen should be fixed in its frame so that the frame does not rotate, but only revolves about the lamp on the rack.

10.4 The following examples illustrate the various types of lightfastness assessment possible:

Grade	Meaning
6	Normal lightfastness grade.
6(1)	Specimen undergoes slight permanent change after a short exposure but on subsequent exposure it is as resistant as Standard 6.
6(P4)	Specimen undergoes slight change after a short exposure to high intensity radiation but this virtually disappears on storage in the dark; apart from this slight photochromic change, the specimen is as resistant as Standard 6.
6(P2)	Specimen undergoes very marked change after a short exposure to high intensity radiation but this virtually disappears on storage in the dark. As far as resistance to permanent photochemical change (fading) is concerned, the specimen is as resistant as Standard 6.
	10.5 Temporary changes in color which may be due to lower moisture content and/or higher temperature and whose existence can be ascertained by a hot pressing test should not be reported as photochromic.

Dye and Pigment Migration in a Pad-Dry Process: Evaluation of

Developed in 1974 by AATCC Committee RA87; reaffirmed 1976, 1977, 1980; editorially revised and reaffirmed 1985, 1990, 2001; editorially revised 1987, 1991, 1998; revised 1992 (with title change), 1996 (with title change). Technically equivalent to ISO 105-Z06.

1. Purpose and Scope

1.1 This test method provides a means of assessing the migration propensity of a pad liquor system containing dyes or pigments, subsequently referred to as colorants, and which may also contain different types and amounts of migration inhibitors.

1.2 When drying conditions are not constant and/or uniform, uneven migration may occur, causing shade variations during a run, or shade differences between the face and back, or between side and center of the fabric.

2. Principle

2.1 Fabric impregnated with colorant alone, or with colorant and auxiliaries, is dried while partially covered with a watch glass permitting differential drying and, therefore, migration to occur. The degree of migration is evaluated by visual examination, or by reflectance measurements of the covered and uncovered areas.

3. Terminology

3.1 **colorant**, n.—a material which is applied to a substrate for the express purpose of changing the transmittance or reflectance of visible light.

NOTE: Dyes, pigments, tints and optical brighteners are examples of colorants; soils are not colorants.

3.2 **dye**, n.—a colorant applied to or formed in a substrate, via the molecularly dispersed state, which exhibits some degree of permanence.

3.3 **migration**, n.—*in textile processing, testing, storage and use*, movement of a chemical, dye or pigment between fibers within a substrate or between substrates due to capillary forces. (see also *transfer*.)

3.4 **pigment**, n.—a colorant in particulate form which is insoluble in a substrate, but which can be dispersed in the substrate to modify its color.

4. Safety Precautions

NOTE: These safety precautions are for information purposes only. The precautions are ancillary to the testing procedures and are not intended to be all inclusive. It is the user's responsibility to use safe and proper techniques in handling materials in this test method. Manufacturers MUST be consulted for specific details such as material safety data sheets and other manufacturer's recommendations. All OSHA standards and rules must also be consulted and followed.

4.1 Follow good laboratory practices. Wear safety glasses in all laboratory areas.

4.2 Observe padder safety. Normal safeguards on padders should not be removed. Ensure that there is an adequate guard at the nip point. A foot-operated kickoff is recommended.

4.3 Handle all chemicals with care. Use chemical goggles or face shield, impervious gloves and an impervious apron when preparing buffered mock dyebaths with concentrated acids and sodium hydroxide.

4.4 An eyewash/safety shower should be located nearby and a self-contained breathing apparatus should be readily available for emergency use.

4.5 Exposure to chemicals used in this procedure must be controlled at or below levels set by governmental authorities (e.g., Occupational Safety and Health Administration's [OSHA] permissible exposure limits [PEL] as found in 29 CFR 1910.1000 of January 1, 1989). In addition, the American Conference of Governmental Industrial Hygienists (ACGIH) Threshold Limit Values (TLVs) comprised of time weighted averages (TLV-TWA), short term exposure limits (TLV-STEL) and ceiling limits (TLV-C) are recommended as a general guide for air contaminant exposure which should be met (see 13.1).

5. Uses and Limitations

5.1 This method offers two alternative procedures:

5.1.1 Procedure A. The fabric/glass assembly (see 8.2) is allowed to dry at room temperature. The procedure is very simple, but time consuming (overnight).

5.1.2 Procedure B. The fabric/glass assembly (see 8.3) is dried in a laboratory dryer or oven, either with or without air circulation. This procedure is faster, but somewhat more complicated.

5.2 The test method may be used to

compare the migration propensity of dyes and the effect on migration of different types of migration inhibitors, thickeners and electrolyte.

5.3 The test method may be used to evaluate a pad liquor with which migration has been found on a continuous dye range. The pad liquor composition may be modified by varying the amount or type of migration inhibitors and tested in the laboratory prior to the application on the range. The colorant concentrations, substrate and wet pickup should be the same in the laboratory as used on the range. It is then possible to correlate the test results with the improvement experienced in practice.

6. Apparatus and Materials

6.1 Laboratory padder.

6.2 Glass plate, 600 × 350 mm (Procedure A).

6.3 Watch glasses (90 mm), 22 mm arch punch.

6.4 Aluminum rings: 110 mm outer diameter, 80 mm inner diameter and 1 mm thickness (Procedure B).

6.5 Clips (Procedure B).

6.6 Laboratory dryer or oven (Procedure B).

6.7 Gray Scale for Color Change (for visual evaluation) (see 13.2).

6.8 Spectrophotometer (for evaluation by reflectance).

6.9 Fabric swatches (see 13.3 and 8.2.1 or 8.3.1).

7. Test Specimen

7.1 Colorant(s) in required concentration(s).

7.2 Migration inhibitors, thickening agents and other auxiliaries (e.g., electrolyte for reactive dyes) may be used as appropriate.

8. Procedure

8.1 Pad Bath Preparation.

8.1.1 Prepare a pad bath appropriate to the colorant(s) with or without a migration inhibitor.

8.2 Procedure A: Drying in Air at Room Temperature.

8.2.1 Pad a 150 × 300 mm swatch of fabric at 20 ± 2°C (68 ± 4°F). Other padding temperatures may be used, but must then be stated in the report. Generally use a wet pickup of 60%, but adjust as necessary to simulate wet pickup of a particular fabric to be run on a particular range (see 13.4).

8.2.2 Immediately after padding place the fabric on a flat glass plate. Place the watch glass on the fabric as shown in Fig. 1 and leave the fabric to dry at room temperature. Record the room temperature and relative humidity during drying.

8.2.3 Remove the watch glass.

8.3 Procedure B: Pin Frame Oven Drying.

8.3.1 Pad a 110 × 220 mm swatch of fabric at 20 ± 2°C (68 ± 4°F). Other padding temperatures may be used, but must then be stated in the report. Generally, use a wet pickup of 60%, but adjust as necessary to simulate wet pickup of a particular fabric to be run on a particular range (see 13.4).

8.3.2 Immediately after padding mount the fabric taut on a pin frame, and sandwich it between two watch glasses, one on the fabric face and one directly underneath on the back of the fabric. Hold the watch glasses in place with two aluminum rings and clamps as shown in Fig. 2.

8.3.3 Dry the fabric horizontally at 100 ± 2°C for approximately 7 min (or until dry) in a laboratory dryer or oven, with or without air circulation.

8.3.4 Remove the watch glasses.

9. Evaluation

9.1 Visual Evaluation.

9.1.1 Compare the depth of color of the fabric that was covered by the watch glass(es), Area A, to the depth of color of the fabric that was not covered, Area B, by reference to the Gray Scale for Color Change (see 13.5) and assign a migration grade (see 10.4), (refer to AATCC Evaluation Procedures 1 and 7).

9.2 Evaluation by Reflectance Measurement.

9.2.1 Determine the reflectance of the watch glass(es) covered area of the fabric, Area A, and of the uncovered area of the fabric, Area B, using a spectrophotometer (see 13.5 and 13.6).

9.2.2 Convert the reflectance values to K/S values to 4 decimal places, using equation (1). The percent migration is calculated to the nearest 1% from equation (2), (refer to AATCC Evaluation Procedure 6, 4.3 and 4.5).

$$(1) K/S = (1 - R)^2/2R$$

where:

R = reflectance factor at the wavelength of maximum absorption. (The wavelength should be determined for the reference Area B and used for both measurements.)

$$(2) \%M = 100 [1 - (K/S)_a / (K/S)_b]$$

where:

$(K/S)_a$ = K/S value of Area A (specimen)

$(K/S)_b$ = K/S value of Area B (reference)

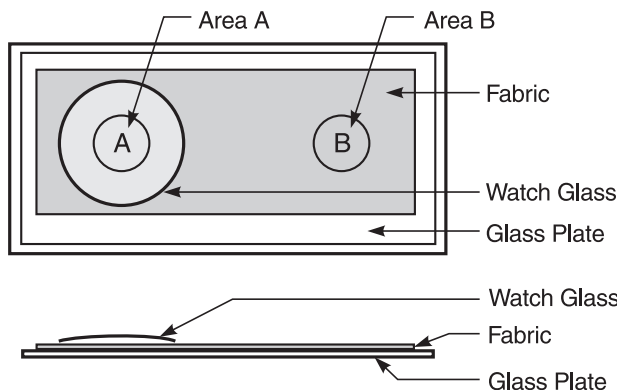

Fig. 1—Layout of apparatus for inducing colorant migration using procedure A.

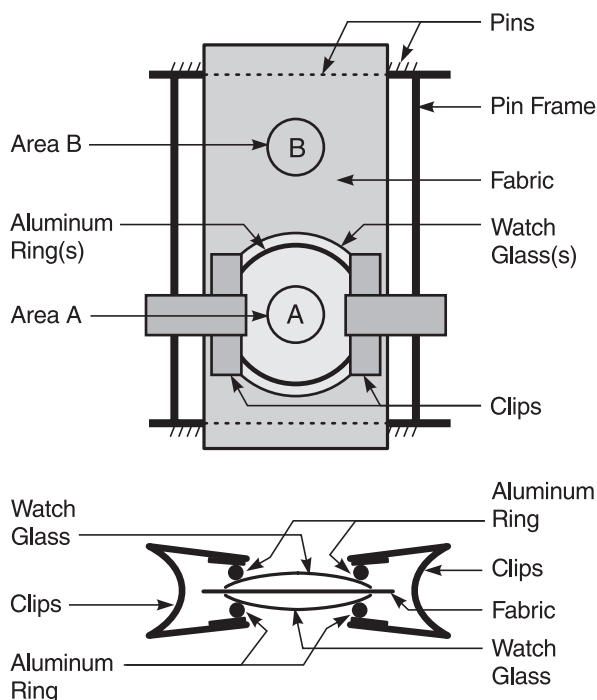

Fig. 2—Layout of apparatus for inducing colorant migration using procedure B.

10. Report

10.1 Report substrate, pad liquor composition, including dyes, chemicals, auxiliaries, etc. and wet pickup.

10.2 For Procedure A, report room temperature and relative humidity during drying.

10.3 For Procedure B, report whether dried with or without air circulation.

10.4 For visual examination, report assessment on a scale of 1-5 by reference to the Gray Scale for Color Change:

- Grade 5—no migration
- Grade 4—slight migration
- Grade 3—medium migration
- Grade 2—severe migration
- Grade 1—very severe migration

10.5 For reflectance measurements, report percent migration using the outer dyed area as reference.

11. Precision and Bias

11.1 Precision for this test method has not been established. Until a precision statement is generated for this test method, use standard statistical techniques in making any comparisons of test results for either *within-laboratory* or *between-laboratory* averages.

12. References

- 12.1 Etters, J. N., *Textile Chemist and Colorist*, Vol. 4, 1972, No. 6, p160.
- 12.2 Etters, J. N., *Modern Knitting Man-*

agement, Vol. 51, 1973, No. 2, p24.

12.3 Gerber, H., *Melliand Textblberichte*, Vol. 53, 1972, No. 3, p335.

12.4 Lehmann, H., and Somm, F., *Textile Praxis International*, Vol. 28, 1973, No. 1, p52.

12.5 Northern Piedmont Section, AATCC, *Textile Chemist and Colorist*, Vol. 7, 1975, No. 11, p192.

12.6 Urbanik, A., and Etters, J. N., *Textile Research Journal*, Vol. 43, 1973, p657.

13. Notes

13.1 Available from Publications Office, ACGIH, Kemper Woods Center, 1330 Kemper Meadow Dr., Cincinnati OH 45240; tel: 513/742-2020.

13.2 Available from AATCC, P.O. Box 12215, Research Triangle Park NC 27709; tel: 919/549-8141; fax: 919-549-8933; e-mail: orders@aatcc.org.

13.3 For disperse dyes, vat dyes and pigments, generally the preferred fabric is a 65/35 polyester/cotton gabardine or heavy twill, heat-set, bleached and mercerized. For soluble dyes with affinity to cellulose (e.g., reactive dyes) a bleached and mercerized 100% cotton gabardine or heavy twill should be used. However, any other fabric intended for use on a continuous dye range may be chosen.

13.4 The desired wet pickup is obtained by adjusting the pressure at the nip of the pad rolls. Wet pickup is the weight gained by the substrate at ambient conditions after

padding:

$$\% \text{ wet pickup} = 100 \times (A/B - 1)$$

where:

A = weight after padding

B = weight before padding

13.5 More accurate results may be obtained when, prior to the visual evaluation or measurement, the dye on the fabric is fixed by relevant, conventional methods; e.g., disperse dyes by thermosol, vat and reactive dyes by pad-steam. (Pigments do not change their aspect significantly by a conventional resin curing process.)

13.6 AATCC Evaluation Procedure 6, Instrumental Color Measurement (see 13.2).

Compatibility of Basic Dyes for Acrylic Fibers

Developed in 1974 by AATCC Committee RA87 (see 10.1); reaffirmed 1976, 1977, 1980, 1989; revised 1984; editorially revised 1985, 1988; editorially revised and reaffirmed 1987, 1994, 1999, 2004. Technically equivalent to ISO 105-Z03.

1. Purpose and Scope

1.1 In the dyeing of acrylic fibers with basic dyes, the classic parameters—e.g., the time of half-dyeing—of individual dyes do not give a true indication of their dyeing behavior in admixture with other basic dyes.

1.1.1 Since basic dyes show virtually no migration in acrylic fibers under normal dyeing conditions, compatibility is of major importance in selecting dye combinations with optimum level dyeing behavior (see 10.2).

1.2 This test method is intended to determine the behavior of a dye in relation to its compatibility when applied to acrylics (see 10.3, 10.4 and 10.5).

2. Principle

2.1 Compatibility is assessed against one of two defined five-step scales, a yellow scale and a blue scale. The assessment should be made using the scale showing the greatest difference in hue from that of the dye under test.

2.1.1 The compatibility value of the dye is assessed by determining its dyeing behavior in combination with each of the standard dyes in the relevant scale.

2.1.2 The recommended standard dyes have been chosen because: (a) they form two series encompassing the compatibility behavior of nearly all basic dyes recommended for acrylic fibers; (b) the dyes in a series are spaced to produce approximately equal visual effects; and (c) the corresponding standard dyes from both scales are compatible (see 10.4).

3. Terminology

3.1 **basic dye**, n.—a dye that dissociates in an aqueous medium to give a positively charged colored ion (cation) with affinity for fibers containing acidic groups.

3.2 **compatibility**, n.—in textile dyeing, propensity of individual dye components in a combination shade to exhaust at similar rates resulting in a buildup of shade that is constant, or nearly constant, in hue throughout the dyeing process.

4. Safety Precautions

NOTE: These safety precautions are for information purposes only. The precautions are ancillary to the testing procedures and are not intended to be all inclusive. It is the user's responsibility to use safe and proper techniques in handling materials in this test method. Manufacturers MUST be consulted for specific details such as material safety data sheets and other manufacturer's recommendations. All OSHA standards and rules must also be consulted and followed.

4.1 Good laboratory practices should be followed. Wear safety glasses in all laboratory areas and a single use dust respirator while handling powder dyes.

4.2 All chemicals should be handled with care.

4.3 Use chemical goggles or face shield, impervious gloves and an impervious apron during handling of concentrated acetic acid.

4.4 An eyewash/safety shower should be located nearby and an organic vapor respiratory with full facepiece should be readily available for emergency use.

4.5 The basic dyes listed in this method belong to the following classes:

- C.I. Basic Orange 42—Azo-methineazo
- C.I. Basic Yellow 29—Methine
- C.I. Basic Yellow 28—Monoazo
- C.I. Basic Yellow 15—Monoazo
- C.I. Basic Orange 48—Azo
- C.I. Basic Blue 69—Methine
- C.I. Basic Blue 45—Anthraquinone
- C.I. Basic Blue 47—Anthraquinone
- C.I. Basic Blue 22—Anthraquinone
- C.I. Basic Blue 77—Triarylmethane

4.6 Exposure to chemicals used in this procedure must be controlled at or below levels set by governmental authorities (e.g., Occupational Safety and Health Administration's [OSHA] permissible exposure limits [PEL] as found in 29 CFR 1910.1000 of January 1, 1989). In addition, the American Conference of Governmental Industrial Hygienists (ACGIH) Threshold Limit Values (TLVs) comprised of time weighted averages (TLV-TWA), short term exposure limits (TLV-STEL) and ceiling limits (TLV-C) are recommended as a general guide for air contaminant exposure which should be met (see 10.9).

5. Standard Dyes (see 10.6)

5.1 The constitution of the scales, and recommended amounts of standard dyes, to be used in the test, are as shown in Table I.

Table I

Amount of Standard Dye (% owf) ¹	C.I. Basic	Compatibility Value
	Yellow	
0.45	Orange 42	1.0
0.25	Yellow 29 (200%)*	2.0
0.15	Yellow 28 (200%)*	3.0
0.75	Yellow 15	4.0
0.65	Orange 48	5.0
	Blue	
0.55	Blue 69	1.0
2.7	Blue 45	2.0
0.6	Blue 47 (200%)*	3.0
0.6	Blue 77	4.0
1.2	Blue 22 (200%)	5.0

¹Note: (owf) means "on weight of fabric" and dyes marked with an (*) are 200% (see 10.8)

The percentages given produce dyeings approximately 1/2 of 1/1 standard depth of many acrylic fibers (see 10.7).

6. Apparatus and Materials

6.1 Thirty samples (pieces of skeins) of equal weight of acrylic fiber.

6.2 Any apparatus that can be used for dyeing at a 40:1 liquor:goods ratio at the required constant temperature.

6.3 A supply of the standard dyes.

6.4 Acetic acid (glacial).

6.5 Sodium acetate crystals ($\text{CH}_3\text{COONa} \cdot 3\text{H}_2\text{O}$).

6.6 A supply of deionized or distilled water, which does not change significantly in pH on boiling.

7. Procedure

7.1 Pretreat the samples of material to be used in the test for 10 min at approximately 95°C in a solution containing 1% (owf) acetic acid (glacial) and 1% (owf) sodium acetate crystals ($\text{CH}_3\text{COONa} \cdot 3\text{H}_2\text{O}$) [to give pH 4.5 (± 0.2)] at a liquor to goods ratio of 40:1. Then lightly squeeze the material and keep it wet ready for use.

7.2 Set five dyebaths, one for each of the standard dyes, at 95°C, a liquor to goods ratio of 40:1 and a pH value of 4.5 ± 0.2 with:

X% Standard dye (blue or yellow)

Y% Dye under test

1% Acetic acid (glacial)

1% Sodium acetate crystals ($\text{CH}_3\text{COONa} \cdot 3\text{H}_2\text{O}$)

Y% corresponds to the amount of dye under test required to give a dyeing approximately 1/2 of 1/1 standard depth on the acrylic fiber chosen. X% is as given in 5.1.

7.2.1 These percentages and the liquor: goods ratio refer to the weight of an individual sample; i.e., to one skein or piece as defined and not to the combined weight of the six samples required for each of the series of dyeings.

7.3 Four to six samples of material are needed for each dyebath. Proceed with each of the prepared dyebaths as follows:

Enter the first sample of material into the dyebath at the required temperature (see 10.2) for the required time at this temperature. Remove this sample and replace it by the second sample of material and dye as before. Repeat this procedure with the remaining two to four samples, except that the last sample is dyed to complete exhaustion.

7.4 Rinse and dry each sample immediately after it is removed from the dyebath. Mount the samples in the sequence in which they were dyed.

8. Assessment

8.1 The compatibility value assigned to the dye under test is that of the standard dye with which it gives on-tone dyeings throughout the sequence. A typical example of the results obtained in assessing a blue dye could be as shown in Table II.

8.2 It is possible for the compatibility value of a dye to lie between two adjacent standards; e.g., to be 1.5, 2.5, 3.5 or 4.5. In these instances a series of on-tone dyeings will not be obtained with any of the standard dyes.

8.3 If a dye is found which lies outside the scale as defined, then a value of less than 1, or greater than 5, whichever is appropriate, should be assigned.

Table II

Compatibility Value of Yellow Standard	Appearance of Sequence of Samples
1.0	Progressively much bluer
2.0	Progressively bluer
3.0	On-tone
4.0	Progressively yellower
5.0	Progressively much yellower

The compatibility value of the blue dye is 3.0.

9. Precision and Bias

9.1 *Precision.* Precision for this test method has not been established. Until a precision statement is generated for this test method, use standard statistical techniques in making any comparisons of test results for either *within-laboratory* or *between-laboratory* averages.

9.2 *Bias.* The compatibility of basic dyes for acrylic fibers can be defined only in terms of a test method. There is no independent method for determining the true value. As a means of estimating this property, the method has no known bias.

10. Notes

10.1 This test method corresponds to a Proposed Method of the Society of Dyers and Colourists, *JSDC*, Vol. 88, June 1972, pp. 220-222.

10.2 Acrylic fibers can vary widely in their dyeing characteristics. The test is to be conducted in such a manner that all available dye is exhausted in approximately equal portions onto the number of fiber samples used. In order to accomplish this, it may be necessary to adjust the dyeing temperature within a range of 90-100°C and/or the dyeing time for each sample in the range of 5-10 min. Suggested times and temperatures for some typical fibers are:

Acrilan 16—93°C, 5 min intervals

Acrilan SEF—96°C, 5 min intervals (except for blue C-1 and yellow C-2 standard, use 93°C)

Orlon 75—96°C, 10 min intervals (except for C-1 standard, use 5 min)

Creslan—88°C, 5 min intervals

10.3 The test is valid only under the conditions defined. Compatibility values may be affected by the presence of anionic substances—e.g., anionic surfactants or anionic dyes—in the dyebath.

10.4 The yellow and blue standard dyes of compatibility value 2.0 are not fully compatible when applied in combination. The differences observed are exaggerated if wet-spun acrylic fibers are used.

10.5 It should be clearly understood that the test is one for compatibility and not a measure of the extent to which incompatibility may lead to unlevelness when combinations of basic dyes are applied to acrylic fibers.

10.6 Sets of 10 basic dyes (5 blue and 5 yellow) packaged 50 g per bottle may be ordered from AATCC Technical Center, P.O. Box 12215, Research Triangle Park NC 27709; tel: 919/549-8141; fax: 919/549-8933; e-mail: orders@aatcc.org.

10.7 For ease in visual assessment, it is recommended to use the dyes under test and the standard dyes in a concentration which produces approximately 1/2 of 1/1 standard depth when dyed on most acrylic fibers. Booklets illustrating 1/1 standard depth as well as other levels of standard depth for 18 hues are available from AATCC, P.O. Box 12215, Research Triangle Park NC 27709; tel: 919/549-8141; fax: 919/549-8933; e-mail: orders@aatcc.org. It should be understood, however, that it is not critical that the compatibility is assessed at standard depth, since identical values are obtained at other depths and in other ratios of standard and test dye.

10.8 The strength of dyes indicated above as 200% were changed in strength in August 1984. The (% owf) is therefore 1/2 of that used in previous years. For example, C. I. Basic Yellow 29 (200%) at 0.25% would be 0.50% of C. I. Basic Yellow 29 (100%).

10.9 Available from Publications Office, ACGIH, Kemper Woods Center, 1330 Kemper Meadow Dr., Cincinnati OH 45240; tel: 513/742-2020.

Appearance of Flocked Fabrics after Repeated Home Laundering and/or Coin-Op Drycleaning

Developed in 1975 by AATCC Committee RR81; reaffirmed 1978, 1989, 2000; editorially revised and reaffirmed 1983, 1994, 2005; editorially revised 1985, 1986, 1988, 1991, 1993, 1996, 2004.

1. Purpose and Scope

1.1 This test method covers a procedure for evaluating the durability of flocked fabric to home laundering or coin-op drycleaning with the use of flock loss and appearance at the edgewear areas of simulated pant leg specimens as the criteria.

2. Principle

2.1 Simulated pant leg specimens prepared as described in 6.1 are laundered or drycleaned as set out in 7.1 and 7.2 and then evaluated for appearance and durability as described in Section 8.

3. Terminology

3.1 **drycleaning**, n.—the cleaning of fabrics with organic solvents such as petroleum solvent, perchloroethylene or fluorocarbon.

NOTE: The process also includes adding detergent and moisture to the solvent, up to 75% RH, and hot tumble drying to 71°C (160°F).

3.2 **laundering**, n.—of textile materials, a process intended to remove soils and/or stains by treatment (washing) with an aqueous detergent solution and normally including subsequent rinsing, extracting and drying.

4. Safety Precautions

NOTE: These safety precautions are for information purposes only. The precautions are ancillary to the testing procedures and are not intended to be all inclusive. It is the user's responsibility to use safe and proper techniques in handling materials in this test method. Manufacturers MUST be consulted for specific details such as material safety data sheets and other manufacturer's recommendations. All OSHA standards and rules must also be consulted and followed.

4.1 Good laboratory practices should be followed. Wear safety glasses in all laboratory areas.

4.2 The 1993 AATCC Standard Refer-

ence Detergent may cause irritation. Care should be taken to prevent exposure to skin and eyes.

4.3 All chemicals should be handled with care.

4.4 Perchloroethylene is toxic by inhalation, by repeated contact with skin and by ingestion; it should be used only in a well vented atmosphere. Toxicology studies with laboratory animals have shown evidence of cancer in rats and mice exposed to perchloroethylene vapors at 100-400 ppm concentrations for prolonged times. Fabric saturated with this solvent should be dried in an adequately ventilated hood. Use chemical goggles or face shield, impervious gloves and an impervious apron when handling perchloroethylene.

4.5 An eyewash/safety shower should be located nearby and an organic vapor respirator should be readily available for emergency use.

4.6 Exposure to chemicals used in this procedure must be controlled at or below levels set by governmental authorities (e.g., Occupational Safety and Health Administration's [OSHA] permissible exposure limits [PEL] as found in 29 CFR 1910.1000 of January 1, 1989). In addition, the American Conference of Governmental Industrial Hygienists (ACGIH) Threshold Limit Values (TLVs) comprised of time weighted averages (TLV-TWA), short term exposure limits (TLV-STEL) and ceiling limits (TLV-C) are recommended as a general guide for air contaminant exposure which should be met (see 11.6).

5. Apparatus and Materials

5.1 Patterns for pant leg panels made from 3 mm (0.125 in.) tempered Masonite or other suitable material. See Fig. 1 for panel dimensions.

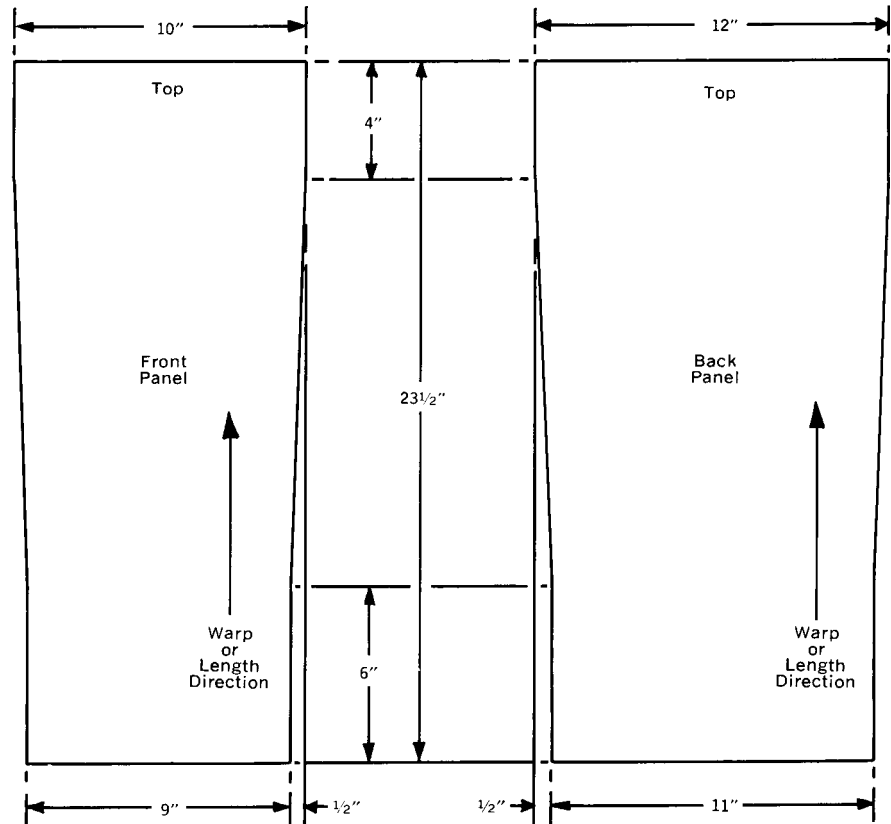

Fig. 1—Simulated pant leg for edgewear evaluation.

5.2 Sewing machine—Home type, 301 plain stitch, 8-10 stitches/25 mm (1.0 in.).

5.3 Sewing thread—Good quality general purpose cotton.

5.4 Sears Kenmore Automatic Washer or equivalent (see 11.3).

5.5 Sears Kenmore Automatic Dryer or equivalent (see 11.3). Gas or electric with 5-min tumble cooling period at the end of the drying cycle.

5.6 Detergent, low sudsing, 1993 AATCC Standard Reference Detergent (see 11.2).

5.7 Ballast of 920 × 920 ± 30 mm (36 × 36 ± 1 in.) hemmed pieces of bleached cotton sheeting (Wash load ballast type 1) (see 11.5).

5.8 Norge Coin-Op Drycleaning Unit or similar equipment (see 11.4).

5.9 AATCC comparison photographs, set of 5 (see Fig. 2 and section 11.1).

6. Test Specimens

6.1 Replicate sets (two sets each for laundering and drycleaning) of simulated pant leg specimens prepared as follows.

6.2 Cut one front and one back panel for each simulated pant leg required, with the longer 600 mm (23.5 in.) dimension in the fabric length direction.

Place a front panel over a back panel with the face sides together and align the lengthwise cut edges on one side. Stitch the two panels together about 16 mm (0.625 in.) in from the cut edges, along with 600 mm (23.5 in.) length, using the 301 stitch, 00-3 cord sewing thread and 8-10 stitches per 25 mm (1.0 in.). Next, align the opposite lengthwise cut edges and stitch together in the same manner as above.

Turn the tubular specimen inside out so that the face side is on the outside.

For pant leg specimens without cuffs, turn in the top and bottom edges to form 51-mm (2-in.) hems and stitch in position about 6 mm (0.25 in.) from the raw edges. Be sure to burst open the side seams (no pressing) before stitching in these areas.

The patterns for the simulated pant leg allow for a cuff at the bottom end. For a cuffed leg, turn in and stitch the top hem as above. At the bottom, turn in a 76 mm (3-in.) length and stitch as above, then turn up the hem to make a 38 mm (1.5 in.) cuff and tack at both side seams.

NOTE 1—Separate test specimens are required for washing and drycleaning.

NOTE 2—Normally creases are not pressed in simulated pant leg specimens made from flocked fabrics. However, if pressed-in creases are desired in flocked fabric specimens, the pressing procedure used should be representative of that used by commercial manufacturers.

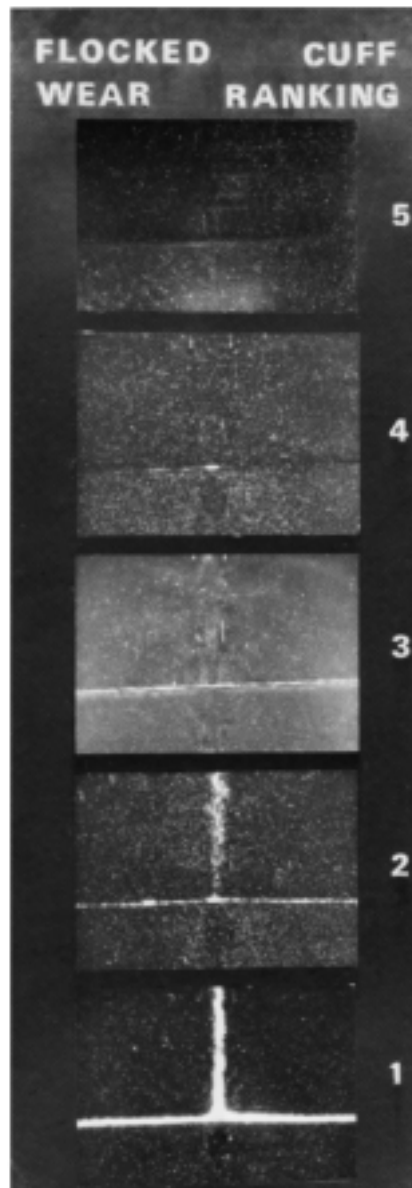

Fig. 2—Photographs for ranking edgewear of flocked fabrics.

7. Procedure

7.1 Laundering—The test specimens are washed as part of 1.84-kg (4-lb) load made up with ballast of Type 128 sheeting, at 49°C (120°F), full water level, 12-min suds cycle, using sufficient low sudsing detergent for good running suds, normal agitation, 40°C (105°F) rinse, full automatic cycle including final spin. At the completion of the wash cycle, remove specimens and ballast from the washer, separate pieces and place wash load (test specimens and ballast) in the dryer and tumble until dry (approximately 35 min) at the medium setting [stack temperature 60-71°C (140-160°F)]. At the completion of the drying cycle, remove the load from the dryer and separate the pieces.

The above washing and drying procedure is repeated for the specified number of wash/dry cycles. Allow for a 30-min relaxation period between each drying and washing.

7.2 Coin-Op Drycleaning—The test specimens are drycleaned as part of a 1.82-kg (4-lb) load, made up with dummy pieces of drycleanable fabrics. The coin-op unit with perchloroethylene solvent (about 1% charge system) shall be run for the full cycle which includes tumble drying. At the end of each drycleaning cycle, remove the load from the unit, and separate the pieces.

The above drycleaning is repeated for the desired number of cycles. Allow for a 30-min relaxation period between drycleanings.

8. Evaluation

8.1 After the desired number of laundering or drycleaning cycles, specimens are opened and laid flat with the side seam in the center of the examination area.

8.2 Compare the edgewear at hems, cuffs and seams as above prepared with the AATCC comparison photographs and rate using a ranking scale of:

- 5—None
- 4—Slight
- 3—Noticeable
- 2—Considerable
- 1—Severe

8.2.1 Take care to ensure that the rating is based on flock loss and not on flattened or matted pile that can be restored by methods such as brushing. A magnifying glass is often required to make this judgment.

9. Report

9.1 Report the grade determined in 8.2 and also report the number of laundering and/or drycleaning cycles at which the ranking value was obtained.

10. Precision

10.1 *Precision*. Laundering—Intralaboratory repeatability $\sigma \pm 0.20$ ranking unit.

Laundering—Interlaboratory reproducibility $\sigma \pm 0.30$ ranking unit.

Drycleaning—Intralaboratory repeatability $\sigma \pm 0.25$ ranking unit.

Drycleaning—Interlaboratory reproducibility $\sigma \pm 0.60$ ranking unit.

10.2 *Bias*. Appearance of flocked fabrics after repeated home laundering and/or coin-op drycleaning can be defined only in terms of a test method. There is no independent method for determining the true value. As a means of estimating this property, the method has no known bias.

11. Notes

11.1 Available from AATCC, P.O. Box 12215, Research Triangle Park NC 27709; tel: 919/549-8141; fax: 919/549-8933; e-mail: orders@aatcc.org.

11.2 The 1993 AATCC Standard Reference Detergent or equivalent may be used following the criteria of low sudsing, good detergent efficiency and free rinsing.

11.3 Contact AATCC, P.O. Box 12215, Research Triangle Park NC 27709; tel: 919/549-8141; fax: 919/549-8933; e-mail: orders@

aatcc.org, for model number(s) and source(s) of approved washer(s) and dryer(s). Any other washer or dryer which is known to give comparable results may be used.

11.4 Norge Coin-Op Drycleaning Model DML-5832 or equivalent, e.g.:

Capacity: 4.5 kg (10 lb).
Drum diam: 66 cm (26 in.).
Drum depth: 41 cm (16 in.).
Number of fins: 4.
Cleaning cycle rpm: 46.

Spin cycle rpm: 162/325.

11.5 Ballast are available from Testfabrics Inc., P.O. Box 26, 415 Delaware St., W. Pittston PA 18643; tel: 570/603-0432; fax: 570/603-0433; e-mail: testfabric@aol.com; and Textile Innovators Corp., div. of SDL Atlas L.L.C., P.O. Box 8, 101 Forest St., Windsor NC; tel: 252/794-9703; fax: 252/794-9704; e-mail: tic@sdlatlas.com.

11.6 Available from Publications Office, ACGIH, Kemper Woods Center, 1330 Kemper Meadow Dr., Cincinnati OH 45240; tel: 513/742-2020.

Appearance of Apparel and Other Textile End Products after Repeated Home Laundering

Developed in 1975 by AATCC Committee RA61; revised 1982, 1989, 1992, 1996; editorially revised and reaffirmed 1984, 2001; editorially revised 1986, 1991, 1997, 2004, 2005. Technically equivalent to ISO 15487.

1. Purpose and Scope

1.1 This test method is designed for evaluating the smoothness appearance of flat fabric and seams, and the retention of pressed-in creases in garments and other textile products after repeated home laundering.

1.2 Any washable textile end product may be evaluated for smoothness appearance, seam smoothness and crease retention using this method.

1.3 Textile end products containing fabrics of any construction, such as woven, knit and nonwoven, may be evaluated according to this method.

1.4 Techniques for seaming and creasing are not outlined since the purpose is to evaluate textile end products as they will be supplied from manufacturing or as ready for use. Furthermore, seaming or creasing techniques would be controlled by fabric properties.

2. Principle

2.1 Textile end product items are subjected to standard home laundering practices. A choice is provided of hand or machine washing, alternative machine wash cycles and temperatures, and alternative drying procedures. Evaluation is performed using a standard lighting and viewing area by rating the appearance of specimens in comparison with appropriate reference standards.

3. Terminology

3.1 **appearance of textile end products**, n.—the overall visual impression of a textile end product quantified by comparison of individual components with appropriate reference standards.

3.2 **ballast**, n.—in procedures for processing or testing of textiles, material that is used to bring the total weight or volume of the textiles to an amount specified in the procedure.

3.3 **crease retention**, n.—in fabrics, the visual impression of an inserted crease quantified by comparison with a set of reference standards.

3.4 **dryer creases**, n.—sharp folds or lines running in any direction in a laundered or dried specimen.

NOTE: Dryer creases are an unintended result of restricted movement of specimens in the washer or the dryer.

3.5 **durable press**, adj.—having the ability to retain substantially the initial shape, flat seams, pressed-in creases and unwrinkled appearance during use and after laundering or drycleaning.

3.6 **laundering**, n.—of textile materials, a process intended to remove soils and/or stains by treatment (washing) with an aqueous detergent solution and normally including rinsing, extracting and drying.

3.7 **seam smoothness**, n.—in fabrics, the visual impression of planarity of a seamed specimen quantified by comparison with a set of reference standards.

3.8 **smoothness appearance**, n.—in fabrics, the visual impression of planarity of a specimen quantified by comparison with a set of reference standards.

4. Safety Precautions

NOTE: These safety precautions are for information purposes only. The precautions are ancillary to the testing procedures and are not intended to be all inclusive. It is the user's responsibility to use safe and proper techniques in handling materials in this test method. Manufacturers MUST be consulted for specific details such as material safety data sheets and other manufacturer's recommendations. All OSHA standards and rules must also be consulted and followed.

4.1 Good laboratory practices should be followed. Wear safety glasses in all laboratory areas.

4.2 The 1993 AATCC Standard Reference Detergent may cause irritation. Care should be taken to prevent exposure to skin and eyes.

4.3 All chemicals should be handled with care.

4.4 Manufacturer's safety recommendations should be followed when operating laboratory testing equipment.

4.5 When evaluating crease retention, use of a lamp with a shield can aid in prevention of burns that could result from lamp heat.

5. Uses and Limitations

5.1 This test method is designed to be used only for evaluating the appearance

of washable fabrics after repeated home laundering.

5.2 The test procedure is designed to reflect the capabilities of home laundry equipment which is currently used by consumers. In general, it is preferable to conduct the test under relatively severe laundering conditions.

5.3 Prints and patterns may mask the mussiness present in textile end products. The rating process is, however, based on the visual appearance of specimens including such effects.

5.4 The interlaboratory reproducibility of the results of this test method depends upon mutual agreement by users of the method on the washing and drying conditions as outlined in 8.1 and the weighting factors to use for individual components of the items as described in 9.7.1.

6. Apparatus and Materials

6.1 Automatic washing machine (see 12.1).

6.2 Automatic tumble dryer (see 12.1).

6.3 Drip dry and line dry facilities.

6.4 A 9.5 L (10.0 qt) pail.

6.5 1993 AATCC Standard Reference Detergent (see 12.2 and 12.7).

6.6 Ballast of 920 × 920 ± 30 mm (36 × 36 ± 1 in.) hemmed pieces of bleached cotton sheeting (Wash load ballast type 1) or 50/50 polyester/cotton plain weave (Wash load ballast type 3) (see 12.3).

6.7 Lighting and evaluation area in an otherwise darkened room using the overhead lighting arrangement shown in Fig. 1 (see 12.4). It has been the experience of many observers that light reflected from the side walls near the viewing board can interfere with the rating results. It is recommended that the side walls be painted matte black (85° Gloss less than 5 units) or that blackout curtains be mounted on both sides of the viewing board to eliminate the reflective interference.

6.8 A 500-watt DXC (RFL-2) flood lamp with reflector and light shield, positioned as shown in Fig. 2, for evaluating crease retention.

6.9 Standard AATCC Three-Dimensional Smoothness Appearance Replicas, set of six (see Fig. 3 and 12.2).

6.10 Standard AATCC Photographic Seam Smoothness Replicas prepared for rating single- and double-needle seams (see Fig. 4 and 12.2). The reproductions shown in Fig. 4 should not be used for rating.

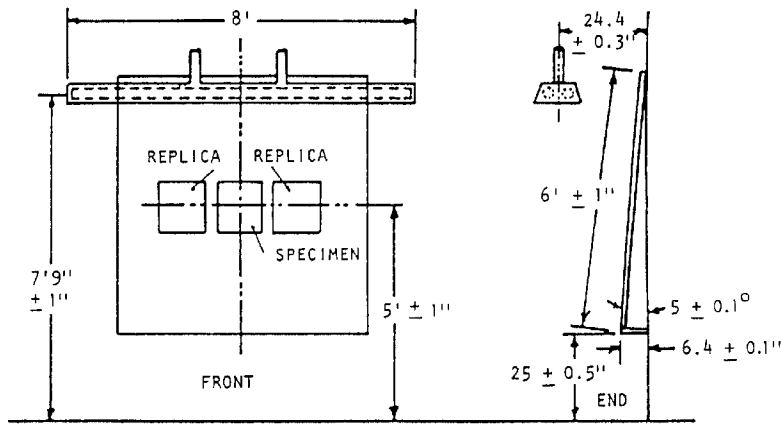

Fig. 1—Lighting equipment for viewing test specimens.

Materials list: (a) Two 8-ft Type F96 CW (Cool White) preheat Rapid Start fluorescent lamps (without baffle or glass). (b) One white enamel reflector (without baffle or glass). (c) One general type swatch mount, spring loaded. Fabricate using light sheet metal (22 ga.). (d) One ¼ in. plywood mounting board painted to match No. 2 gray chip on AATCC Gray Scale for Staining.

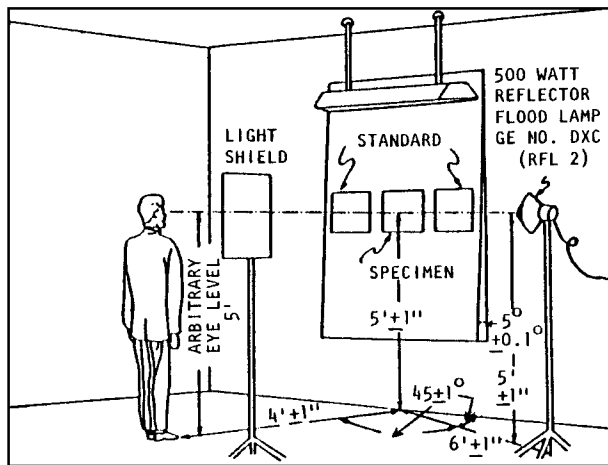

Fig. 2—Lighting and viewing arrangement for crease retention.



Fig. 3—AATCC 3-D smoothness appearance replicas.

6.11 Standard AATCC Three-Dimensional Crease Replicas, set of five (see Fig. 5 and 12.2).

6.12 Steam or dry iron with appropriate fabric temperature settings.

6.13 Detergent (for hand wash).

6.14 Scale with at least 5 kg or 10 lb capacity.

7. Test Specimens

7.1 For textile end product tests, select three items for testing.

8. Procedure

8.1 Tables II, III and IV summarize the alternate washing and drying conditions and settings. Additional information on the machine and laundering conditions may be found in the monograph, *Standardization of Home Laundry Test Conditions*, elsewhere in this TECHNICAL MANUAL.

8.1.1 It is recognized that special cycles or features are available on current washing machines and dryers to achieve improved performance on certain items; i.e., gentle cycles with reduced agitation to protect delicately constructed items, and durable press cycles, with cool-down or cold rinses and reduced spin speeds, to minimize wrinkling. In evaluating appearance retention, however, the more severe *Normal* or *Cotton Sturdy* machine cycle is considered most appropriate. If modifications to any of the cycles (see 8.2) are used, these must be reported in the results (see Section 10).

8.2 Standard washing.

8.2.1 Hand Wash—(see 12.7). Dissolve 20.0 ± 0.1 g of 1993 AATCC Standard Reference Detergent in 7.57 ± 0.06 L (2.00 ± 0.02 gal) of water at $41 \pm 3^\circ\text{C}$ ($105 \pm 5^\circ\text{F}$) in a 9.5 L (10.0 qt) pail and then add the three textile end product specimens. Wash for 2.0 ± 0.1 min with no twisting or wringing. Rinse once using 7.57 ± 0.06 L (2.00 ± 0.02 gal) of water at $41 \pm 3^\circ\text{C}$ ($105 \pm 5^\circ\text{F}$). Remove the specimens and dry by Procedure C, Drip (see 8.3.3).

8.2.2 Machine Wash—Use specified water level, the selected water temperature for the washing cycle and a rinse temperature of less than 29°C (85°F). If this rinse temperature is not attainable, record available rinse temperature.

8.2.3 Add 66.0 ± 0.1 g of 1993 AATCC Standard Reference Detergent. In soft water areas this may be reduced to avoid excessive sudsing, but in that case the amount should be stated in the report of test results.

8.2.4 Add textile end product specimens and enough ballast to make a 1.8 ± 0.06 kg (4.00 ± 0.13 lb) load. Evaluation of heavy textile end product items may require the addition of ballast beyond the 1.8 kg limit to balance the load where

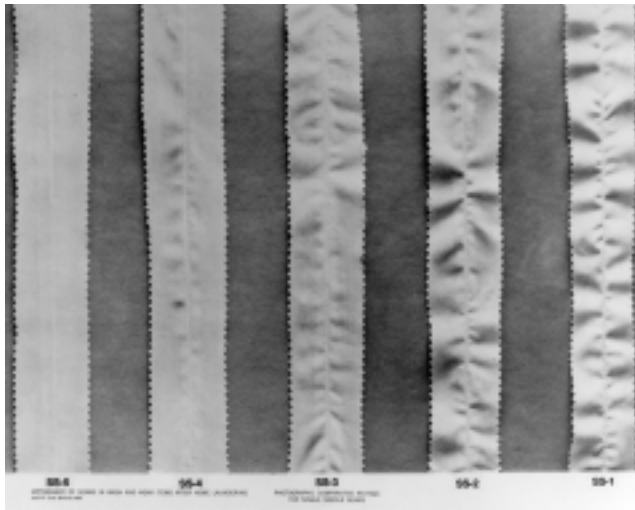

A. For single needle seams.

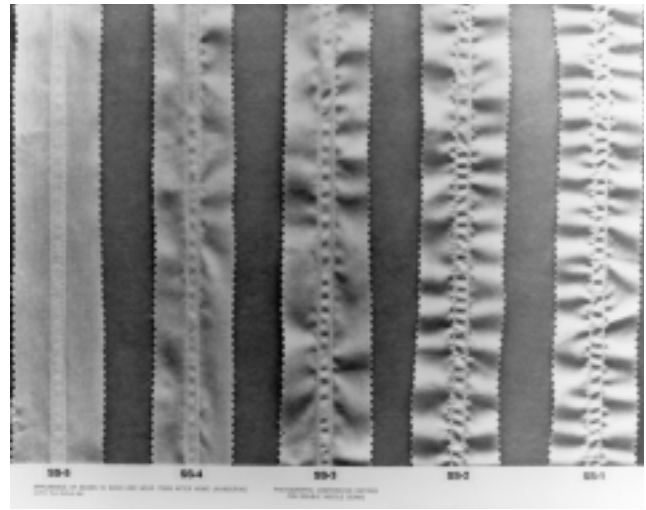

B. For double needle seams.

Fig. 4—AATCC photographic seam smoothness replicas.

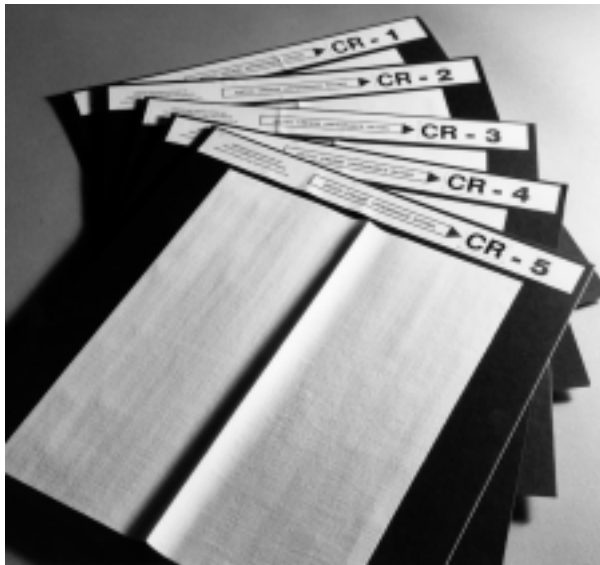

Fig. 5—AATCC crease retention replicas.

distribution is a problem. A weight limit of 2.7 ± 0.06 kg (6.00 ± 0.13 lb) may then be used and noted in the report. Set the washer for the selected washing cycle and time (see Tables II and III). Normal or Cotton Sturdy is recommended. For very critical evaluations and in arbitration, limit the number of specimens per washer load to those from one sample.

8.2.5 For specimens to be dried by Procedures A, B or D, allow washing to proceed automatically through the final spin cycle. Remove the test specimens *immediately* after the final spin cycle, separate tangled pieces, taking care to minimize distortion, and dry by Procedure A, B or D (see Tables II and IV).

8.2.6 For specimens to be dried by Pro-

cedure C, Drip Dry, remove the specimens from the washer just before the water begins to drain for the final rinse cycle. Remove specimens soaking wet.

8.2.7 Washer creases. Specimens may be in a folded or creased conformation after removal from the washer. Such creases present after laundering should be straightened out prior to drying.

8.3 Drying.

8.3.1 (A) Tumble Dry. Place the washed load (test specimens and ballast) in the tumble dryer and set the temperature control to generate the correct exhaust temperatures as specified in Table IV. For fibers that are heat sensitive, lower temperatures consistent with producers' recommendations are required,

and must be reported. Operate the dryer until the total load is dry. Remove the load immediately after the machine stops. Avoid overdrying. Static cling becomes a problem with overdrying, particularly with lightweight items, because it prevents the specimens from tumbling freely.

8.3.2 (B) Line Dry. Textile end product items are to be hung on an appropriate hanger, straightening and smoothing facings, seams, etc. Allow specimens to hang in still air at room temperature until dry.

8.3.3 (C) Drip Dry. Textile end product items should be hung as described in 8.3.2. Allow specimens to hang in still air at room temperature until dry.

8.3.4 (D) Screen Dry. Spread each specimen on a horizontal screen or perforated surface, removing wrinkles but not distorting or stretching the specimen. Allow the specimens to dry in still air at room temperature.

8.3.5 Dryer creases. If specimens are folded or creased after any drying cycle but the last, they should be rewet and an attempt should be made to remove the creases prior to additional washing and drying. No attempt to remove wrinkles or creases should be made after the fifth cycle of drying.

8.4 Repeat the selected washing and drying cycles four more times or to an agreed number of cycles.

8.5 Prior to evaluation, precondition and then condition test specimens as directed in ASTM D 1776, Standard Practice for Conditioning and Testing Textiles (see 12.6). Condition the test specimens for a minimum of 4 h in the standard atmosphere for textile testing [$21 \pm 1^\circ\text{C}$ ($70 \pm 2^\circ\text{F}$) and $65 \pm 2\%$ RH]. Textile end product items should be hung for conditioning as described in 8.3.2.

Table I—Wash Load Ballast: Finished Fabric Specification

Fiber Content	Wash Load Ballast Type 1 100% Cotton	Wash Load Ballast Type 3 50/50 ± 3% poly/cotton
Yarns	16/1 ring spun	30/2 ring spun
Fabric Construction	52 (± 2) × 48 (± 2)	48 (± 2) × 48 (± 2)
Fabric Weight	155 ± 5 g/m ² (4.55 ± 0.15 oz/yd ²)	155 ± 5 g/m ² (4.55 ± 0.15 oz/yd ²)
Piece Size	92.0 × 92.0 ± 3 cm (36.0 × 36.0 ± 1 in.)	92.0 × 92.0 ± 3 cm (36.0 × 36.0 ± 1 in.)
Piece Weight	130 ± 10 g	130 ± 10 g

Table II—Alternative Washing and Drying Conditions (see 8.1)

Machine Cycle	Wash Temperatures	Drying Procedures
Hand, in pail	(III) 41 ± 3°C (105 ± 5°F)	(A) Tumble:
(1) Normal/Cotton Sturdy	(IV) 49 ± 3°C (120 ± 5°F)	i. Cotton Sturdy
	(V) 60 ± 3°C (140 ± 5°F)	ii. Delicate
(2) Delicate		iii. Permanent Press
(3) Permanent Press		(B) Line
		(C) Drip
		(D) Screen

Table III—Washing Machine Conditions (see 8.1)

	Normal/Cotton Sturdy	Delicate	Permanent Press
Water Level	18 ± 1 gal	18 ± 1 gal	18 ± 1 gal
Agitator Speed	179 ± 2 spm	119 ± 2 spm	179 ± 2 spm
Washing Time	12 min	8 min	10 min
Spin Speed	645 ± 15 rpm	430 ± 15 rpm	430 ± 15 rpm
Final Spin Cycle	6 min	4 min	4 min

Table IV—Dryer Conditions (see 8.1)

	Cotton Sturdy	Delicate	Durable Press
Exhaust Temperature	High 66 ± 5°C (150 ± 10°F)	Low < 60°C (140°F)	High 66 ± 5°C (150 ± 10°F)
Cool Down Time	10 min	10 min	10 min

Table V—Fabric Smoothness Grades by SA Replica Equivalents

Grade	Description
SA-5	Equivalent to the SA-5 Replica. Very smooth, pressed, finished appearance.
SA-4	Equivalent to the SA-4 Replica. Smooth, finished appearance.
SA-3.5	Equivalent to the SA-3.5 Replica. Fairly smooth but nonpressed appearance.
SA-3	Equivalent to the SA-3 Replica. Mussed, nonpressed appearance.
SA-2	Equivalent to the SA-2 Replica. Rumpled, obviously wrinkled appearance.
SA-1	Equivalent to the SA-1 Replica. Crumpled, creased and severely wrinkled appearance.

9. Evaluation

9.1 Three trained observers should rate each test specimen independently.

9.2 The overhead fluorescent light should be the only light source for the viewing board. All other lights in the room should be turned off except when rating crease appearance. In that case the floor lamp with reflector and light shield, positioned as shown in Fig. 2, is also

required.

9.3 The observer is to stand directly in front of the specimen 1.2 ± 0.3 m (4 ft ± 1 in.) away from the board. It has been found that normal variations in the height of the observer above and below the arbitrary 1.5 m (5.0 ft) eye level have no significant effect on the grade given.

9.4 Smoothness Appearance.

9.4.1 Mount the test specimen on the viewing board as illustrated in Fig. 1,

with the fabric length in the vertical direction. Place the most similar three-dimensional plastic replicas on each side of the test specimen to facilitate comparative rating.

9.4.2 Although the 3-D Smoothness Appearance (SA) replicas were cast from woven fabrics, it is understood that these wrinkled surfaces do not duplicate all possibilities of fabric surfaces. The replicas are to be used as guides which represent various levels of fabric smoothness or freedom from wrinkles. The observer should mentally integrate degree and frequency of wrinkles in the specimen to determine a level of smoothness that can be identified with the SA replica number which most nearly represents that smoothness appearance level; see Table V.

9.4.3 Assign the numerical grade of the replica which most nearly matches the smoothness appearance of the test specimen, or assign a grade midway between those whole-number standards which have no half-number standards separating them (SA-1.5, SA-2.5, SA-4.5) if the appearance of the test specimen warrants it.

9.4.4 An SA-5 grade is equivalent to the SA-5 replica and represents the smoothest appearance, while an SA-1 replica represents very poor appearance.

9.4.5 If dryer creases are present on any specimens to be evaluated, take care in rating the specimens. Some dryer creases can be disregarded (commonly called “reading out”). When the grade of a dryer creased specimen differs from the other specimens by more than one grade, the test should be repeated with new specimens, taking all precautions to avoid the occurrence of dryer creases.

9.5 Appearance of Seams.

9.5.1 Mount the test specimen on the viewing board with the seam in the vertical direction. Place the appropriate single- or double-needle standard seam smoothness (SS) replicas beside the specimen to facilitate comparative rating.

9.5.2 Confine observations to the area influenced by the seam and disregard the appearance of the surrounding fabric.

9.5.3 Assign the numerical grade of the photographic standard which most nearly matches the appearance of the seam in the test specimen.

9.5.4 A seam smoothness grade of SS-5 is equivalent to the appearance of Standard No. 5, the best level of seam appearance; a seam smoothness grade of SS-1 is equivalent to that of Standard No. 1, which represents a very poor level of seam appearance.

9.6 Appearance of Creases.

9.6.1 Mount the test specimen on the viewing board with the crease in the vertical direction. Place the most similar three-dimensional plastic crease replicas (CR) on each side of the test specimen to

facilitate comparative rating. Mount replicas 1, 3 and 5 on the left and 2 and 4 on the right.

9.6.2 The flood lamp with reflector and light shield are to be positioned in the viewing area, as shown in Fig. 2, and used during the rating process.

9.6.3 Confine observations to the crease itself and disregard the appearance of the fabric.

9.6.4 Assign the numerical grade of the replica which most nearly matches the appearance of the crease in the test specimen.

9.6.5 A crease retention grade of CR-5 is equivalent to the appearance of Standard No. 5, the best level of crease appearance; a crease retention grade of CR-1 is equivalent to that of Standard No. 1, which represents a very poor level of crease appearance.

9.7 Appearance of Textile End Products.

9.7.1 The individual components to be evaluated in each test item shall be deter-

mined and entered on a Rating Chart (Fig. 6).

9.7.2 If it is desired to designate certain components as more or less important to the overall appearance of the item, weighting factors should be added to the Rating Chart.

9.7.3 The weighting factors to be assigned to each component are:

3—Very important to overall item appearance.

2—Moderately important to overall item appearance.

1—Slightly important to overall item appearance.

9.7.4 Mount the item on the viewing board so that the center of the area or component to be rated is approximately 1.5 m (5.0 ft) from the floor as illustrated in Fig. 1. Place the appropriate three-dimensional plastic replicas or photographs in proper position to facilitate comparative rating (refer to 9.4, 9.5, or 9.6).

9.7.5 If the item is exceptionally large, such as a sheet, comforter, bedspread, curtain or drapery, fold the item lengthwise to produce a panel half the original width. Place this half panel over a rod so that the fabric length is vertical and the folded item is in equal quarters. The rod should be sufficiently long to accommodate the half width item. The rod with the large item is attached to the rating board at approximately 1.8 m (6.0 ft) from the floor. The standard replicas or photographs are positioned to facilitate comparative rating. Evaluate the area across the full width of the quartered panel at the same eye level as the replicas. Evaluate all four quarters in the same manner and report average grade for each component evaluated in the test item.

10. Report

10.1 Option 1—Using Weighting Factors—Total the weighting factors assigned to each component in the rating chart (Fig. 6) and multiply by 5. This gives the maximum point value achievable by the item. Multiply the average grade recorded for each component by its assigned weighting factor. Total these values to obtain the actual point value achieved by the item. Report as the percentile value of the item the number obtained by dividing the actual point value by the maximum point value achievable and multiplying by 100. This value is the unit of measure of this test method.

10.2 Option 2—Report average grades on each individual component of each test item, using the Average Grade column of the Rating Chart.

10.3 State washing procedure (Arabic number and Roman numeral) and drying procedure (capital letter and subscript) from Table II, as well as type of wash load ballast (Arabic number). Any deviations from stated procedures, such as use of a modified wash cycle, a reduced amount of detergent or a higher than usual load limit, should be explained completely.

10.4 For example, smoothness appearance grade SA-3.8 (1-IV-A(i)-3) denotes a crease retention grade of 3.8 for specimens washed using a Normal (Cotton Sturdy) cycle at 49°C (120°F) with Wash load ballast type 3 and tumble dried using the Normal (Cotton Sturdy) cycle.

10.5 If fraying occurs in laundering at seams or elsewhere within the product, the location and amount should be noted.

11. Precision and Bias

11.1 Smoothness appearance

11.1.1 Precision and bias of this test procedure are being established.

11.2 Appearance of seams

11.2.1 Precision and bias of this test procedure are being established.

Identification:

Component (Characteristic, Attribute)	Weighting Factor (10.1)	Average Grade (10.2)	Point Value
	X	=	
	X	=	
	X	=	
	X	=	
	X	=	
	X	=	
	X	=	
	X	=	

	Total Point Value	—		X 100 =	
Total Weighting Factor		X 5 = Point Value			

Fig. 6—Rating chart.

11.3 Appearance of creases

11.3.1 Precision and bias of this test procedure are being established.

11.4 Until a precision statement is generated for this test method, use standard statistical techniques in making any comparisons of test results for either *within-laboratory* or *between-laboratory* averages.

12. Notes

12.1 Contact AATCC, P.O. Box 12215, Research Triangle Park NC 27709; tel: 919/549-8141; fax: 919/549-8933; e-mail: orders@aatcc.org, for model number(s) and source(s) of approved washer(s) and dryer(s). Any other washer or dryer which is known to give comparable results may be used. Washing machine conditions given in Table III represent the actual speeds and times available on the current specified model(s). Other washers may vary in one or more of these settings. Dryer machine conditions given in Table IV represent the actual temperatures and cool-down times available on the current specified model(s). Other dryers may

vary in one or more of these settings.

12.2 Available from AATCC, P.O. Box 12215, Research Triangle Park NC 27709; tel: 919/549-8141; fax: 919/549-8933; e-mail: orders@aatcc.org.

12.3 Ballast are available from Testfabrics Inc., P.O. Box 26, 415 Delaware St., W. Pittston PA 18643; tel: 570/603-0432; fax: 570/603-0433; e-mail: testfabric@aol.com; and Textile Innovators Corp., div. of SDL Atlas L.L.C., P.O. Box 8, 101 Forest St., Windsor NC; tel: 252/794-9703; fax: 252/794-9704; e-mail: tic@sdlatlas.com. Ballast fabrics should conform to specifications in Table I.

12.4 The use of 8-ft fixtures for viewing laundered specimens is specified in this method. It is recognized, however, that physical limitations in certain laboratories will prevent the use of 8-ft fixtures. In those situations, 4-ft lights may be used but replicas identified as SA-4, SA-3 and SA-1 should always be placed on the left side of the viewing board as the board is viewed from the front. Replicas identified as SA-5, SA-3.5 and SA-2 should always be placed on the viewing board to the right side as the board is viewed from the front.

12.5 Like other hand wash procedures,

this procedure has inherent limitations; e.g., limited reproducibility of the type of action involved due to the human element.

12.6 ASTM standards are available from ASTM, 100 Barr Harbor Dr., West Conshohocken PA 19428; tel: 610/832-9500; fax: 610/832-9555.

12.7 The AATCC Technical Center conducted a study to compare the 1993 AATCC Standard Reference Detergent, AATCC Standard Reference Detergent 124 and two different types of fabrics (current and proposed) to be used as ballast, under the following test conditions:

Machine cycle: (1)—Normal/Cotton Sturdy
Washing Temp: (V)— $60 \pm 3^\circ\text{C}$ ($140 \pm 5^\circ\text{F}$)
Drying Procedure: (A)i—Tumble dry, cotton sturdy cycle
Fabrics tested: White Twill (100% cotton)
Beige Twill (100% cotton)
Grey Poplin (100% cotton)
Blue Twill (50/50 poly/cotton)

No significant differences were found in the results using either detergent or ballast load fabrics.

Alkali in Wet Processed Textiles: Total

Developed in 1975 by AATCC Committee RA34; reaffirmed 1977, 1980, 1986, 1992, 2002; editorially revised 1985, 1990; revised (with title change) 1987, 1997.

1. Purpose and Scope

1.1 This test method is used to determine the total alkali content of wet processed textiles. Total alkali can be used to determine washing and/or neutralizing efficiency after certain wet processing steps, particularly bleaching, and can be used as a measure of the suitability of prepared fabric for subsequent dyeing and finishing operations.

2. Principle

2.1 Each specimen is immersed in distilled or deionized water, and the solution is then titrated with a standard acid to a predetermined end point. The percentage of alkali can then be calculated from the amount of acid used and the weight of the specimen.

3. Terminology

3.1 **bleaching**, *n.*—elimination of unwanted coloring matter from a substrate by oxidative or reductive chemical treatment.

3.2 **pH**, *n.*—the negative logarithm of the hydrogen ion activity expressed in gram equivalents per liter used in expressing both acidity and alkalinity on a scale whose values run from 0-14 with 7 representing neutrality, numbers less than 7 increasing acidity, and numbers greater than 7 increasing alkalinity.

3.3 **total alkali**, *n.*—in *textile wet processing*, residual alkaline materials in a wet processed textile expressed as percent sodium hydroxide on dry weight of the textile.

3.4 **wet processing**, *n.*—in *textile manufacturing*, a collective term for processes included in preparation, dyeing, printing, and finishing in which the textile material is treated with a liquid, normally water, or with chemicals in solution or dispersion in a liquid.

4. Safety Precautions

NOTE: These safety precautions are for information purposes only. The precautions are ancillary to the testing procedures and are not intended to be all inclusive. It is the user's responsibility to use safe and proper techniques in handling

materials in this test method. Manufacturers MUST be consulted for specific details such as material safety data sheets and other manufacturer's recommendations. All OSHA standards and rules must also be consulted and followed.

4.1 Good laboratory practices should be followed. Wear safety glasses in all laboratory areas.

4.2 All chemicals should be handled with care.

4.3 If concentrated sulfuric acid is diluted to prepare the 0.10*N* sulfuric acid (see 6.5), use chemical goggles or face shield, impervious gloves and an impervious apron. Concentrated acids should be handled only in an adequately ventilated laboratory hood. CAUTION: Always add acid to water.

4.4 An eyewash/safety shower should be located nearby and a high efficiency particulate respirator with a full facepiece should be readily available for emergency use.

4.5 Exposure to chemicals used in this procedure must be controlled at or below levels set by governmental authorities (e.g., Occupational Safety and Health Administration's [OSHA] permissible exposure limits [PEL] as found in 29 CFR 1910.1000 of January 1, 1989). In addition, the American Conference of Governmental Industrial Hygienists (ACGIH) Threshold Limit Values (TLVS) comprised of time weighted averages (TLV-TWA), short term exposure limits (TLV-STEL), and ceiling limits (TLV-C) are recommended as a general guide for air contaminant exposure which should be met (see 13.1).

5. Uses and Limitations

5.1 In this test method all alkalis detected, such as sodium hydroxide, sodium carbonate, sodium bicarbonate, and other alkaline salts, are calculated as sodium hydroxide. The results are reported as total alkali, expressed as NaOH.

5.2 Since distilled or deionized water can contain dissolved carbon dioxide, care should be taken to remove it by boiling water before use.

6. Apparatus and Reagents

6.1 pH meter with 0.1 unit graduations.

6.2 Beakers, glass, 600 mL.

6.3 Burette, glass, 10 mL with 0.10 mL graduations.

6.4 Buffer solution, pH 4.0 and 7.0.

6.5 Sulfuric acid (H₂SO₄), 0.10*N* (see 13.2).

7. Calibration

7.1 Calibrate the pH meter with pH 4.0 buffer solution in accordance with the manufacturer's instructions. Dual calibration instruments should be calibrated to pH 4.0 and pH 7.0.

8. Test Specimens

8.1 Take samples in the dry or wet state.

8.2 Dry cloth. Select two or more representative dried specimens. Place in oven at 100°C (212°F) for 1 h. Cool in a desiccator and weigh to the nearest 0.1 g. Specimens should weigh 5-10 g.

8.3 Wet cloth. Select two or more representative specimens weighing approximately 10-20 g in the wet state.

9. Procedure

9.1 Place each specimen in a 600 mL beaker containing 450-500 mL distilled or deionized water at room temperature and stir vigorously for 1 min. Cover the beaker and keep the specimen immersed for 15 min. Finally, stir the specimen again and insert the pH meter electrode(s), being careful to avoid contact with the specimen.

9.2 Titrate the water and specimen with 0.10*N* H₂SO₄ to a steady (10 s) pH 3.9 endpoint. Add titrant dropwise followed by gentle agitation of the specimen without touching the electrode(s). Read burette to the nearest graduation (see 13.3).

9.3 If the specimen was taken from a wet sample, rinse and dry the titrated specimen to a constant weight (to the nearest 0.1 g) as in 8.2, being careful to collect any large threads that may have unraveled during the titration procedure.

9.4 Titrate a water blank by repeating 9.2 without a specimen present.

10. Calculation

10.1 Compute the percentage total alkali from the titer according to the following formula:

$$X = [(A - B)(0.04)(N) 100] / W$$

where:

X = % total alkali as sodium hydroxide (NaOH),

A = volume of acid used for specimen, mL,

B = volume of acid used for blank, mL,

N = normality of sulfuric acid (0.10*N*),

W = weight of specimen.

10.2 Compute the sample average by using the formula:

$$x = (x_1 + x_2 + \dots + x_n)/n$$

11. Evaluation

11.1 Total alkalinity is important because of its effect on the subsequent processing operations to which the textile is subjected. Interpretation of test results is usually based on a combination of total alkalinity and pH of the water extracted from the fabric as determined by AATCC Method 81, pH of the Water Extract from Wet Processed Textiles.

11.2 Total alkalinity quantifies the amount of residual alkali in a specimen, per unit of weight, providing the specimen contains alkali.

12. Precision and Bias

12.1 Precision.

12.1.1 In 1993, an interlaboratory study was completed, which included five laboratories, two operators in each, running three determinations per fabric, on four fabrics. No prior assessment was made of the relative level of the partici-

pating laboratories in performance of the test method.

12.1.2 Analysis of the data set ($5 \times 2 \times 3 \times 4 = 120$ values) yielded components of variance as follows.

Components of Variance	Variance
Laboratories	0.000245
Operators within laboratories	0.000061
Specimens within materials, laboratories, and operators	0.000047

12.1.3 Table I (critical differences) was calculated using the values in 12.1.2.

12.1.4 Differences between two averages of N determinations, for the appro-

Table I—Critical Differences for Two Averages—95% Probability Level

Alkali in Wet Processed Textiles: Total (% weight total alkali as sodium hydroxide)

N	Single Operator	Within Laboratory	Between Laboratory
1	0.0190	0.0288	0.0509
2	0.0134	0.0230	0.0491
4	0.0095	0.0209	0.0481
8	0.0067	0.0198	0.0477

priate precision parameter, should reach or exceed the table value to be statistically significant at the 95% probability level.

12.2 Bias.

12.2.1 The values of the total alkali in wet processed textiles can only be defined in terms of a test method. There is no known bias in the determination of this property by this test method. During this study, no determination of the true value was made by an independent, referee analytical method for the purpose of establishing presence or absence of bias.

13. Notes

13.1 Available from Publications Office, ACGIH, Kemper Woods Center, 1330 Kemper Meadow Dr., Cincinnati OH 45240; tel: 513/742-2020.

13.2 For method of preparation of standard acid refer to W. W. Scott, *Standard Methods of Chemical Analysis*, 6th Ed., Van Nostrand, New York, 1962, p1343.

13.3 If preferred, titration may be made with a suitable colorimetric indicator such as methyl orange (pH 3.1-4.4). The precision may be less with this method than with a good pH meter.

Dispersibility of Disperse Dyes: Filter Test

Developed in 1975 by AATCC Committee RA87; reaffirmed 1976, 1977, 1989; revised 1979, 1996; editorially revised 1980, 1983, 1985, 1987, 1995, 2001, 2004; editorially revised and reaffirmed 1984, 1994. Partly equivalent to ISO 105-Z04.

Table I. Selection of Applicable Test

Test	Whatman Filter Paper Combination	Application of Dyes	pH of Dispersion
I	#2 over #4	Package dyeing of polyester	4.5-5.0
II	#4 over #4	Beck dyeing of polyester	4.5-5.0
III	#4 over #4	Dyeing of nylon carpet and apparel	9.0-10.0

1. Purpose and Scope

1.1 This test determines the dispersibility as evaluated by filtering time and filter residue of disperse dyes under standard conditions in aqueous media. Variables which affect accuracy and repeatability of the test are specified in Section 10.

1.2 This test method is to be used for determining the degree of dispersion at the specified conditions in aqueous media only.

2. Principle

2.1 A quantity of disperse dye is prediluted, heated and passed through filter papers of specified micron size. The time of passage and retention of dye is then evaluated.

2.2 Three tests are outlined according to intended dye application (see 10.6 and Table I).

3. Terminology

3.1 **disperse dye**, *n.*—an essentially water insoluble dye having affinity, when properly dispersed, for polyester, polyamide and some other manufactured polymeric fibers.

3.2 **dispersibility**, *n.*—the degree to which particles can be broken down to some minimum size such that they will pass through the interstices of a standard filter paper.

4. Safety Precautions

NOTE: These safety precautions are for information purposes only. The precautions are ancillary to the testing procedures and are not intended to be all inclusive. It is the user's responsibility to use safe and proper techniques in handling materials in this test method. Manufacturers MUST be consulted for specific details such as material safety data sheets and other manufacturer's recommendations. All OSHA standards and rules must also be consulted and followed.

4.1 Good laboratory practices should be followed. Wear safety glasses in all laboratory areas and a single use dust res-

pirator while handling powder dyes.

4.2 All chemicals should be handled with care. The compounds used in this test method at the concentrations specified are considered to present no significant hazard when used in accordance with good laboratory practices.

4.3 If concentrated acetic acid is diluted to prepare the 10% acetic acid, use chemical goggles or face shield, impervious gloves and an impervious apron during preparation. Concentrated acids should be handled only in an adequately ventilated laboratory hood. CAUTION: Always add acid to water.

4.4 An eyewash/safety shower should be located nearby and an organic vapor respirator with full facepiece should be readily available for emergency use.

4.5 Exposure to chemicals used in this procedure must be controlled at or below levels set by governmental authorities (e.g., Occupational Safety and Health Administrator's [OSHA] permissible exposure limits [PEL] as found in 29 CFR 1910.1000 of January 1, 1989). In addition, the American Conference of Governmental Industrial Hygienists (ACGIH) Threshold Limit Values (TLVs) comprised of time weighted averages (TLV-TWA), short term exposure limits (TLV-STEL) and ceiling limits (TLV-C) are recommended as a general guide for air contaminant exposure which should be met (see 10.17).

5. Apparatus and Materials

5.1 Buchner funnel: Coors glazed one-piece porcelain, 110 mm diameter (see 10.2).

5.2 Filter papers: Whatman #2, 110 mm diameter; Whatman #4, 110 mm diameter or exact equivalent filter paper from other sources (see 10.5).

5.3 Stainless steel ring with approximate dimensions 103 mm (4.05 in.) ID, 111 mm (4.33 in.) OD and 8 mm (0.32 in.) height to hold filter paper in place (see 10.8 and 10.14).

5.4 Filtering flask with side tube, capacity 1000 mL.

5.5 Manometer to measure vacuum (pressure drop).

5.6 Vacuum pump or water aspirator to obtain vacuum of 560 ± 100 mm (22 ± 4 in.).

5.7 Vacuum control valve.

5.8 Rubber tubing, vacuum.

5.9 Stopwatch.

5.10 Beakers, 400 mL or larger.

5.11 Balance, analytical.

5.12 Tetrasodium salt of ethylenediaminetetraacetic acid (EDTA) as 25% solution, such as Cheelox BF-12 or equivalent.

5.13 Tetrasodium pyrophosphate, anhydrous (TSPP) ($\text{Na}_4\text{P}_2\text{O}_7$), 10% solution.

5.14 Acetic acid (CH_3COOH), 10% solution.

5.15 Filter Residue Scale (see Fig. 1 and 10.14).

5.16 Distilled or deionized water, which does not change significantly in pH on heating. This water is modified with 0.25 g/L of chelating agent (EDTA) as specified in 5.12.

5.17 Dye samples (see 6.2).

5.18 Stirrer, laboratory, magnetic.

5.19 Graduated cylinder, 250-mL.

5.20 pH meter.

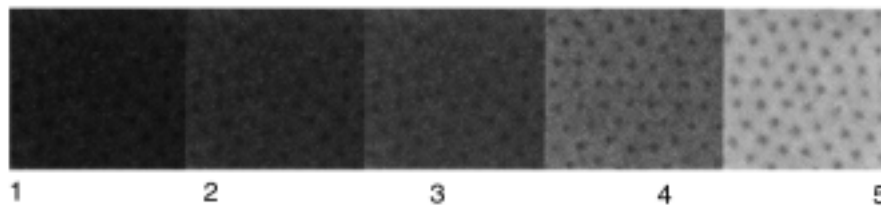

Fig. 1—Filter residue scale.

6. Procedure

6.1 Special water (see 5.16) is further stabilized as follows:

Test I and II (For polyester dyes): distilled or deionized water; 0.25 g/L EDTA (see 5.12); final pH adjustment (see 6.3).

Test III (for nylon dyes): distilled or deionized water; 0.25 g/L EDTA (see 5.12); final pH adjustment (see 6.3) for further explanation see 10.6 and Table 1.

6.2 Weigh out 2.0 ± 0.1 g of dye powder or 4.0 ± 0.2 g of 50% liquid of the dye sample to be tested. Also weigh out an equal quantity of the standard dye (see 10.4, 10.5).

6.3 Add the dye weighed in 6.2 completely and slowly to 200 mL of the vigorously agitated specially treated water (see 5.16) at 43-49°C (110-120°F) in a 400 mL beaker. Use a magnetic stirrer. Adjust pH (see 10.16) as follows: Tests I and II: pH 4.5-5.0 with acetic acid (see 5.14); Test III: pH 9-10 with TSPP (see 5.13, 10.10, 10.11).

6.4 Heat between 5-10 min to 71°C (160°F). Stir by means of a magnetic stirrer to prevent localized heating (see 10.1, 10.12).

6.5 Pour 200-300 mL of 71°C (160°F) water through a 110 mm funnel without filter paper (see 10.9). Wait 25 ± 10 s. Turn vacuum on until the water has passed through the funnel.

6.6 Cut vacuum off and immediately place filter papers in Buchner funnel (see 10.5, 10.6, 10.8 and Table I):

Test I:	Whatman #2 on top Whatman #4 on bottom
Test II:	Whatman #4 on top Whatman #4 on bottom
Test III:	Whatman #4 on top Whatman #4 on bottom

6.7 Insert stainless steel ring in funnel over filter papers and turn on vacuum. Allow vacuum to reach 560 ± 100 mm (22 ± 4 in.) (see 10.7).

6.8 With vacuum on, immediately pour dye dispersion which has been heated to 71°C (160°F) (see 6.4) into funnel and begin timing. Record time up to 120 s to the nearest s. The end point is reached when the appearance of the filter paper changes from a wet to a dry look.

6.9 Allow filter paper to dry and evaluate as outlined in Section 7 (see 10.15).

7. Evaluation

7.1 Record time for filtration and rate as follows:

Class A—0-24 s
Class B—25-49 s
Class C—50-74 s
Class D—75-120 s
Class E—> 120 s

7.2 Examine residue on filter paper

versus the Filter Residue Scale (standard photographic replicas) (see 10.13, 10.14). Also examine the paper for any visible coarse or granular particles (see 10.13). If present the test is automatically rated as Class 1. If none is present, rate as follows:

Class 5—Excellent
Class 4
Class 3—Intermediate values are interpolated
Class 2
Class 1—Poor

8. Report

8.1 Classify and report the following:

(a) Test Number (see 10.6 and Table I).
(b) Class according to filtration rate (see 7.1).

(c) Class according to amount of residue (see 7.2).

Example: I-A-3, where I is the Test Number (Whatman #2 over Whatman #4); A indicates the time of filtration (0-24 s); and 3 represents amount of residue on filter paper as compared with a standard photographic chart.

9. Precision and Bias

9.1 *Precision.* Precision for this test method has not been established. Until a precision statement is generated for this test method, use standard statistical techniques in making any comparisons of test results for either *within-laboratory* or *between-laboratory* averages.

9.2 *Bias.* The dispersibility of disperse dyes can be defined only in terms of a test method. There is no independent method for determining the true value. As a means of estimating this property, the method has no known bias.

10. Notes

10.1 The results of this test method can vary widely unless all details are run under the conditions outlined. Any variation in the conditions can cause the test to be invalid. Results have been shown to be repeatable in several laboratories when the specified conditions were met.

10.2 Variations in results can be caused by differences in the diameter of the filter funnel due to differences in surface area.

10.3 The dye standard is always included so that the influence of any operator induced variable on the results is minimized.

10.4 When evaluating two different dyes of approximately equal shade but of different tinctorial value, one dye is always selected as standard. Then the other product is run on an equal strength (grams/200 mL) basis using as a guide the Standard Depths dyeings (18 hues) as available from AATCC. When evaluating two samples of the same dye, the standard is the one furnished as standard material by the respective dye manufacturer. When evaluating the same dye from two different manufacturers, one should determine if the two products

are of equal strength before running the test. If a strength difference is determined, the two products should be evaluated as outlined in the first two sentences of this paragraph.

10.5 Whatman paper is specified because it was used by all participants in developing this test method. Any other filter paper which gives equivalent results may be used. Two filter papers are used to provide a more uniform vacuum across the filtering surface. The filter paper is used as received in the box with the slick side up to avoid variations due to texture differences on the rough side. The coarser paper should always be on the bottom. Other papers may be used if quality and microrretention are exactly the same as the Whatman paper.

Whatman #2—Filters particles above 8 μ m.

Whatman #4—Filters particles above 25 μ m.

10.6 Tests I, II and III are defined as follows:

Test I—Whatman #2 filter paper over Whatman #4 filter paper. This test is designed to evaluate the most critical dispersion requirements such as for package dyeing of polyester.

Test II—Whatman #4 filter paper over Whatman #4 filter paper. This test is designed to evaluate dispersion requirements for dyeing at longer liquor ratios (such as beck dyeing).

Tests I and II are carried out at an acid pH of 4.5-5.0 to reflect common dyeing practices for disperse dyes on polyester fiber.

Test III—Whatman #4 filter paper over Whatman #4 filter paper. This test is designed to evaluate the dispersion requirements of disperse dyes for application on nylon (carpet and apparel dyeing). The pH of 9-10 specified for this test reflects common industrial practice.

10.7 The vacuum should be 560 ± 100 mm (22 ± 4 in). This range is obtained by using either a standard vacuum pump or a house vacuum. However, a water aspirator may not give this vacuum until a liquid is introduced into the system. In this event the test should proceed after pouring the dye into the funnel and waiting 10-13 s for full vacuum.

10.8 Since the Whatman filter paper is cellulosic in nature, it can swell quite readily when wet out. Therefore, if the paper is prewet, the time of filtration will go up as a result of the wet out temperature and/or time lag. Thus it is *imperative* that the paper not be wet prior to the test, since the micron retention of the paper is reduced. This is the reason for the stainless steel ring, which holds the filter paper in place without prewetting. On dyes which have a very small particle size, the speed of filtration will not be changed to a sizeable degree by a vacuum alteration. However, a reduced vacuum can result in faster filtration times on dyes of larger particle size, since the suction is not as great. On dyes of larger particle size, an increased vacuum will block the paper faster, slowing up the filtration rate, and thus swelling the paper more. This results in higher filtration times and more residual dye on the paper.

10.9 The funnel should always be preheated with 200-300 mL of water heated to 71°C (160°F) and then wiped dry so that the dispersion will not be reduced in temperature by a cold funnel. The preheating cycle should always come just prior to running the tests without the paper in place.

10.10 A concentration of 2 g/200 mL was chosen as representing the upper limit of nor-

mal dye application. On dyes of high tinctorial strength, this can be reduced to 1 g/200 mL, but it should always be reported that 1 g was used.

10.11 It is very important to use 43-49°C (110-120°F) water. Wide variations can result with certain dyes if water at 71°C (160°F) is used at the beginning. The specified procedure allows the dye to wet out under conditions similar to those used in plant practice.

10.12 Excessive time lags and holding temperatures may affect the outcome of the test. Test should be completed within 15 min.

10.13 The Filter Residue Scale consists of photographs representing five classes of retention of filter residue and is used as part of the evaluation procedure (see 7.2).

10.14 Available from AATCC, P.O. Box 12215, Research Triangle Park NC 27709; tel: 919/549-8141; fax: 919/549-8933; e-mail: orders@aatcc.org.

10.15 In order to give more reproducible results, especially with dyes in Class 3 or lower, it may be advisable to rinse the filter paper while it is in the funnel with 10-15 mL of specially prepared water before drying (see 5.16).

This will aid in the removal of any colloidal dye that actually has a micron size smaller than the paper being employed.

10.16 It is necessary to adjust the pH at this point since various dyes have wide pH ranges themselves. For example, the pH of dispersions of paste dyes usually is more alkaline than of dispersions of the same dyes in powder form.

10.17 Available from Publications Office, ACGIH, Kemper Woods Center, 1330 Kemper Meadow Dr., Cincinnati OH 45240; tel: 513/742-2020.

Appendix A. Flow Chart for AATCC Test Method 146-2001

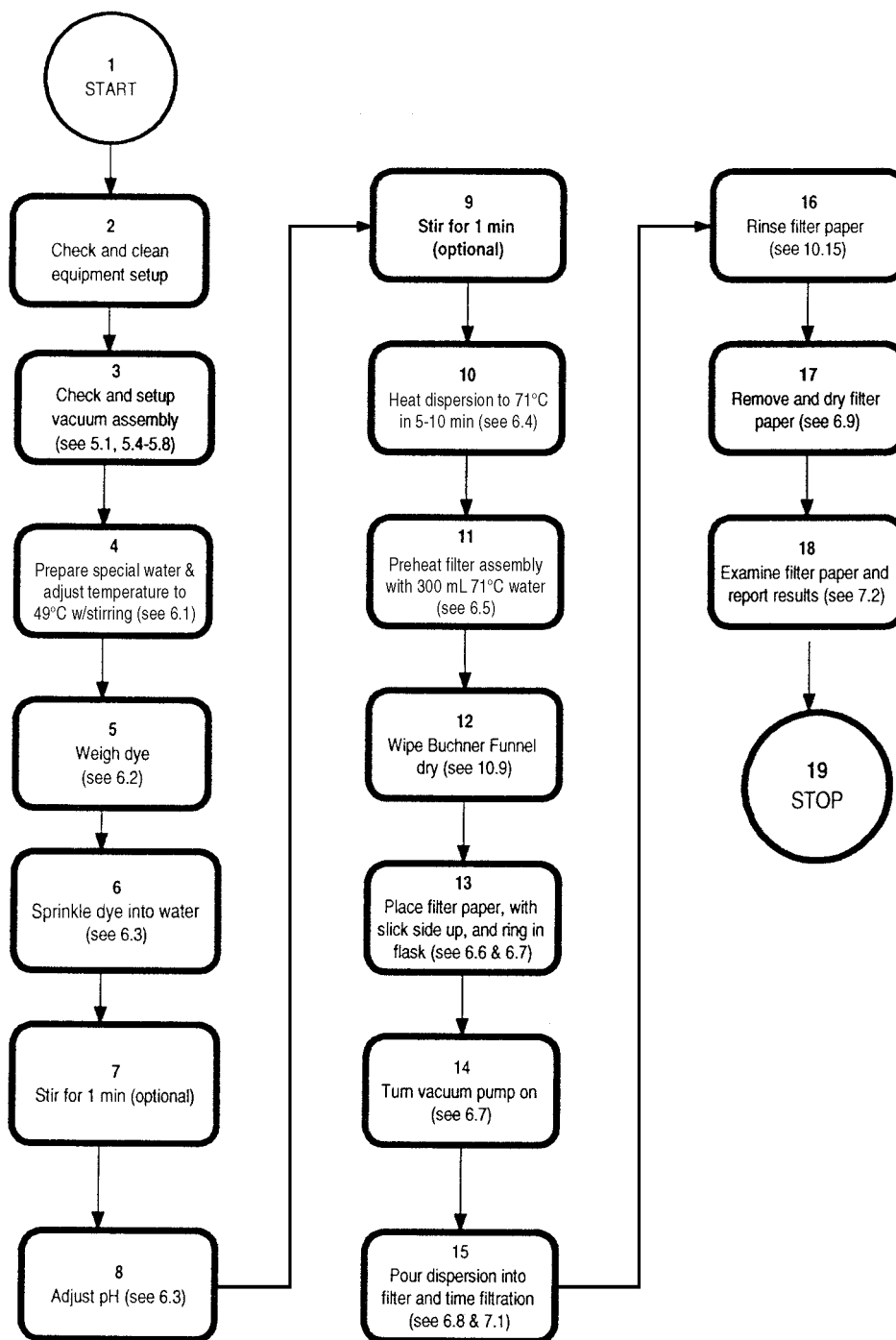

Antibacterial Activity Assessment of Textile Materials: Parallel Streak Method

Developed in 1976 by AATCC Committee RA31; reaffirmed 1977, 1982, 1998; editorially revised 1980, 1982, 1983, 1986; revised 1987, 1988 (with title change), 1993; editorially revised and reaffirmed 2004.

Foreword

The Parallel Streak Method has filled a need for a relatively quick and easily executed qualitative method to determine antibacterial activity of diffusible antimicrobial agents on treated textile materials.

AATCC Method 100, Antibacterial Finishes on Textile Materials, Assessment of, is a quantitative procedure which is adequately sensitive but is cumbersome and time consuming for routine quality control and screening tests. Therefore, when the intent is to demonstrate bacteriostatic activity by the diffusion of the antibacterial agent through agar, Method 147 fulfills this need. In the Parallel Streak Method, the agar surface is inoculated making it easier to distinguish between the test organism and contaminant organisms which may be present on the unsterilized specimen. The Parallel Streak Method has proven effective over a number of years of use in providing evidence of antibacterial activity against both Gram positive and Gram negative bacteria.

1. Purpose and Scope

1.1 The objective is to detect bacteriostatic activity on textile materials. The results of using this procedure have been demonstrated by Committee RA31 to be reproducible by various laboratories working with materials containing residual amounts of antibacterial agents (as determined by chemical assay) after multiple standard washings. The method is useful for obtaining a rough estimate of activity in that the growth of the inoculum organism decreases from one end of each streak to the other and from one streak to the next resulting in increasing degrees of sensitivity. The size of the zone of inhibition and the narrowing of the streaks caused by the presence of the antibacterial agent permit an estimate of the residual antibacterial activity after multiple washings.

2. Principle

2.1 Specimens of the test material, in-

cluding corresponding untreated controls of the same material, are placed in intimate contact with nutrient agar (see 7.1 and 7.4) which has been previously streaked with an inoculum of a test bacterium. After incubation, a clear area of uninterrupted growth underneath and along the sides of the test material indicates antibacterial activity of the specimen. A standard strain of bacteria is used which is specific to the requirements of the material under test. If no other bacterial species is specified, *Staphylococcus aureus* may be used as a representative Gram positive organism. Other recommended strains are listed below in Section 6.

3. Terminology

3.1 **activity**, n.—of an antibacterial agent, a measure of effectiveness of the agent.

3.2 **antibacterial agent**, n.—in textiles, any chemical which kills bacteria (bactericide) or interferes with the multiplication, growth or activity of bacteria (bacteriostat).

3.3 **zone of inhibition**, n.—clear area of no growth of a microorganism, cultured onto the surface of an agar growth medium, in proximity to the borders of a specimen placed in direct contact with this agar surface.

NOTE: A zone of inhibition occurs as a result of the diffusion of an antimicrobial agent from the specimen.

4. Safety Precautions

NOTE: These safety precautions are for information purposes only. The precautions are ancillary to the testing procedures and are not intended to be all inclusive. It is the user's responsibility to use safe and proper techniques in handling materials in this test method. Manufacturers MUST be consulted for specific details such as material safety data sheets and other manufacturer's recommendations. All OSHA standards and rules must also be consulted and followed.

4.1 This test should be performed only by trained personnel. The U.S. Department of Health and Human Services publication *Biosafety in Microbiological and Biomedical Laboratories* should be consulted (see 13.1).

4.2 CAUTION: Some of the bacteria used in this test are pathogenic; i.e., capable of infecting humans and producing disease. Therefore, every necessary and

reasonable precaution must be taken to eliminate this risk to the laboratory personnel and to personnel in the associated environment. Wear protective clothing and respiratory protection that prevents penetration by the bacteria.

4.3 Good laboratory practices should be followed. Wear safety glasses in all laboratory areas.

4.4 All chemicals should be handled with care.

4.5 An eyewash/safety shower should be located nearby for emergency use.

4.6 Sterilize all contaminated samples and test materials prior to disposal.

4.7 Exposure to chemicals used in this procedure must be controlled at or below levels set by government authorities (e.g., Occupational Safety and Health Administrations [OSHA] permissible exposure limits [PEL] as found in 29 CFR 1910.1000 of January 1, 1989). In addition, the American Conference of Governmental Industrial Hygienists (ACGIH) Threshold Limit Values (TLVs) comprised of time weighted averages (TLV-TWA), short term exposure limits (TLV-STEL) and ceiling limits (TLV-C) are recommended as a general guide for air contaminant exposure which should be met (see 13.2).

5. Uses and Limitations

5.1 The method is not suitable for materials which tend to encapsulate and prevent the diffusion of the antibacterial agent or contain antibacterial-neutralizing substances.

6. Test Organisms

6.1 Test bacteria:

6.1.1 *Staphylococcus aureus*, American Type Culture Collection No. 6538. Gram positive organism. (see 13.3)

6.1.2 *Klebsiella pneumoniae*, American Type Culture Collection No. 4352. Gram negative organism. (see 13.3)

6.1.3 Other suitable species can also be used depending on the intended end-use of the test sample.

6.2 Whenever possible, test the activity of the culture to be used against a standard control specimen (a positive control) with known antibacterial activity.

6.3 To determine whether the antibacterial activity is due to the antibacterial agent, test a specimen of the same material treated in exactly the same way with

whatever other finishing agents were used, but without the antibacterial agent. Many standard textile finishing chemicals, especially crease resistant and permanent press reagents, will often give strong antibacterial activity even after many washes.

7. Culture Medium

7.1 Suitable broth/agar media are Nutrient, Trypticase Soy and Brain-Heart Infusion.

Nutrient Broth:

Peptone (Bacto-peptone) (see 13.5)	5 g
Beef extract (see 13.6)	3 g
Distilled water	to 1000 mL

7.2 Heat to a boil to disperse ingredients. Adjust to pH 6.8 ± 0.1 with 1N NaOH solution. (This is not necessary if prepared, dehydrated medium is used.)

7.3 Dispense in 10.0 ± 0.5 mL amounts in conventional bacteriological culture tubes (i.e., 125×17 mm). Plug and sterilize at 103 kPa (15 psi) for 15 minutes.

7.4 Nutrient agar (see 13.4). Add 1.5% bacteriological agar to nutrient (or appropriate) broth. Heat to boiling. Check pH and adjust to 7.1 ± 0.1 using NaOH solution if necessary. Dispense in 15.0 ± 0.5 mL amounts in conventional bacteriological culture tubes, plug, and sterilize at 103 kPa (15 psi) for 15 min. (May be sterilized in 1,000 mL borosilicate glass flasks and petri dishes poured from this.)

8. Maintenance of Culture of Test Organisms

8.1 Using a 4 mm inoculating loop, transfer the culture daily in nutrient (or appropriate medium) broth for not more than two weeks. At the conclusion of two weeks, make a fresh transplant from stock culture. Incubate cultures at $37 \pm 2^\circ\text{C}$ ($99 \pm 3^\circ\text{F}$).

8.2 Maintain stock cultures on nutrient or appropriate agar slants. Store at $5 \pm 1^\circ\text{C}$ ($41 \pm 2^\circ\text{F}$) and transfer once a month to fresh agar (see 13.7).

9. Test Specimens

9.1 Test specimens (non-sterile) are cut by hand or with a die. They may be any convenient size. Rectangular specimens cut 25×50 mm are recommended. A 50

mm length permits the specimens to lie across 5 parallel inoculum streaks each of diminishing width from about 8 mm to 4 mm wide.

10. Procedure

10.1 Dispense sterilized nutrient (or appropriate medium) agar [cooled to $47 \pm 2^\circ\text{C}$ ($117 \pm 4^\circ\text{F}$)] by pouring 15 ± 2 mL into each standard (15×100 mm) flat bottomed petri dish. Allow agar to gel firmly before inoculating.

10.2 Prepare inoculum by transferring 1.0 ± 0.1 mL of a 24 h broth culture into 9.0 ± 0.1 mL of sterile distilled water contained in a test tube or small flask. Mix well using appropriate agitation.

10.3 Using a 4 mm inoculating loop, load one loopful of the diluted inoculum and transfer to the surface of the sterile agar plate by making five streaks approximately 60 mm in length, spaced 10 mm apart covering the central area of a standard petri dish (see 10.1) without refilling the loop. Take care not to break the surface of the agar while making the streaks.

10.4 Gently press the test specimen transversely across the five inoculum streaks to ensure intimate contact with the agar surface. This may be accomplished more easily by pressing the specimen to the agar surface with a biological section lifter or with a spatula which has been sterilized by flaming and then air cooled immediately before use.

10.5 If the specimen curls, preventing intimate contact with the inoculated surface, place sterile glass slides on the ends of the specimen to hold it in place.

10.6 Incubate at $37 \pm 2^\circ\text{C}$ ($99 \pm 4^\circ\text{F}$) for 18-24 h.

11. Evaluation

11.1 Examine the incubated plates for interruption of growth along the streaks of inoculum beneath the specimen and for a clear zone of inhibition beyond its edge. The average width of a zone of inhibition along a streak on either side of the test specimen may be calculated using the following equation:

$$W = (T - D)/2$$

where:

W = width of clear zone of inhibition in mm

T = total diameter of test specimen

and clear zone in mm

D = diameter of the test specimen in mm

11.2 The size of the zone cannot be construed as a quantitative evaluation of antibacterial activity. Treated materials should be compared to an untreated corresponding material and a material specimen with known bacteriostatic activity. Report of results will include an observation of zones of inhibition and growth under the specimen if present. The criterion for passing the test must be agreed upon by the interested parties. To constitute acceptable antibacterial activity, there must be no bacterial colonies directly under the sample in the contact area.

12. Precision and Bias

12.1 Precision for this test method has not been established. Until a precision statement is generated for this test method, use standard statistical techniques in making any comparisons of test results for either *within-laboratory* or *between-laboratory* averages.

13. Notes and References

13.1 Publication available from U.S. Department of Health and Human Services—CDC/NIH-HHS Publication No. (CDC) 84-8395.

13.2 Booklet available from Publications office, ACGIH, Kemper Woods Center, 1330 Kemper Meadow Dr., Cincinnati OH 45240; tel: 513/742-2020.

13.3 American Type Culture Collection, P.O. Box 1549, Manassas VA 20108; tel: 703/365-2700; fax: 703/365-2701.

13.4 Nutrient Agar can be obtained from Difco Laboratories, 920 Henry St., Detroit MI 48201 and from Baltimore Biological Laboratories, 250 Schilling Circle, Cockeysville MD 21030.

13.5 Peptone from Difco Laboratories (address above), or Thiotone from Baltimore Biological Laboratories (address above).

13.6 Beef extract may be obtained from Baltimore Biological Laboratories (address above); Difco Laboratories (address above); or Oxoid USA Inc., 9017 Red Branch Road, Columbia MD 21045.

13.7 Consistent and accurate testing requires maintenance of a pure, uncontaminated, non-mutant test culture. Avoid contamination by using good sterile technique in plating and transferring. Avoid mutation by strict adherence to monthly stock transfers. Check culture purity by making streak plates periodically and observing for a single species-characteristic type of colonies.

Chelating Agents: Chelation Value of Aminopolycarboxylic Acids and Their Salts; Calcium Oxalate Method

Developed in 1976 by AATCC Committee RA90; editorially revised and reaffirmed 1977, 1985 (new title), 1997; reaffirmed 1980, 2002; editorially revised 1984, 1986, 1988 (new title); revised 1992.

1. Purpose and Scope

1.1 The active content of ethylenediaminetetraacetic acid (EDTA), N-hydroxyethylethylenediaminetriacetic acid (HEDTA) and diethylenetriaminepentaacetic acid (DTPA) and their salts is usually expressed by the calcium chelation value (CaCV). This value indicates the amount of calcium (as calcium carbonate) which will be chelated by a known weight of chelating agent.

2. Principle

2.1 The chelation value is determined experimentally by titrating a weighed sample of chelating agent with a calcium ion solution of known concentration. A precipitating anion (oxalate) is present during the titration. As the calcium solution is added, the ions are chelated by the chelating agent and no permanent precipitate is formed as long as there is free chelating agent present. Beyond this point, any excess calcium ion that is added reacts with oxalate anion to form a cloudy precipitate which is the endpoint. The calcium chelation value (CaCV) indicates the amount of calcium (as calcium carbonate) which will be sequestered by a known weight of chelating agent and is expressed as milligrams of calcium carbonate (CaCO_3) per gram of chelating agent (mg calcium carbonate/g chelating agent).

3. Terminology

3.1 **chelating agent**, *n.*—*in textile chemistry*, a chemical capable of deactivating metal ions by formation of a water soluble complex. SYN.—*sequestering agent*.

4. Safety Precautions

NOTE: These safety precautions are for information purposes only. The precautions are ancillary to the testing procedures and are not intended to be all inclusive. It is the user's responsibility to use safe and proper techniques in handling materials in this test method. Manufacturers MUST be consulted for specific

details such as material safety data sheets and other manufacturer's recommendations. All OSHA standards and rules must also be consulted and followed.

4.1 Good laboratory practices should be followed. Wear safety glasses in all laboratory areas.

4.2 All chemicals should be handled with care.

4.3 In preparing, dispensing and handling hydrochloric acid and sodium hydroxide use chemical goggles or face shield, impervious gloves and an impervious apron. Concentrated acids should be handled only in an adequately ventilated laboratory hood. CAUTION: Always add acid to water.

4.4 Diethylamine hydrochloride is an eye, skin and respiratory irritant. It should be handled only in an adequately ventilated hood.

4.5 An eyewash/safety shower should be located nearby and a self-contained breathing apparatus should be readily available for emergency use.

4.6 Exposure to chemicals used in this procedure must be controlled at or below levels set by governmental authorities (e.g., Occupational Safety and Health Administration's [OSHA] permissible exposure limits [PEL] as found in 29 CFR 1910.1000 of January 1, 1989). In addition, the American Conference of Governmental Industrial Hygienists (ACGIH) Threshold Limit Values (TLVs) comprised of time weighted averages (TLV-TWA), short term exposure limits (TLV-STEL) and ceiling limits (TLV-C) are recommended as a general guide for air contaminant exposure which should be met (see 14.1).

5. Uses and Limitations

5.1 Analysis by this method will yield a CaCV which includes partially substituted EDTA, HEDTA and DTPA as well as nitrilotriacetic acid (NTA), iminodiacetic acid (IDA), glycolate and other weak chelating agents. These compounds may be present in some commercial products.

5.2 AATCC Method 168 is an alternative procedure which yields a CaCV that does not include the partially substituted products and weaker chelating agents.

6. Reagents

6.1 Calcium carbonate (CaCO_3).

6.2 Sodium oxalate ($\text{Na}_2\text{C}_2\text{O}_4$).

6.3 Diethylamine hydrochloride [$(\text{C}_2\text{H}_5)_2\text{NH} \cdot \text{HCl}$]

6.4 Sodium hydroxide (NaOH) solution, 50% W/W.

6.5 Hydrochloric acid (HCl) conc.

7. Sampling

7.1 The test should be conducted in triplicate; i.e., three test specimens from a sample should be analyzed.

8. Conditioning

8.1 If solid chelating agent is being evaluated, dry a 2 g sample at the appropriate temperature for at least 2 h and cool in desiccator before weighing specimens.

8.2 Dry free acid forms of chelating agents at 120°C.

8.3 Dry salt forms of chelating agents at 80°C.

9. Specimens

9.1 Do not use aluminum or metallic weighing pans.

9.2 For analysis of solid EDTA, HEDTA and DTPA (either free acid or salt forms) weigh a 0.49-0.51 g specimen of the dried chelating agent to an accuracy of 0.01 g.

9.3 For analysis of commercial solutions of salts of the chelating agents in 9.2 weigh a 1.00-1.20 g specimen of the solution to an accuracy of 0.01 g.

10. Preparation of Reagents

10.1 Calcium Titrant Solution (0.250 M): Weigh 25.0 g of calcium carbonate to an accuracy of 0.1 g and add it to 300 mL of water in a 600 mL beaker with stirring on a magnetic stirrer. Dissolve by adding 43 mL of concentrated hydrochloric acid. Add the hydrochloric acid slowly and carefully to prevent bubbling over and excessive splattering. After the calcium carbonate has dissolved (the solution becomes clear), heat the solution to boiling and allow it to boil for at least 5 min to expel carbon dioxide. Cool the solution to room temperature, transfer it to a 1 L volumetric flask and dilute it to 1 L. Prepare a fresh solution monthly.

10.2 Sodium Oxalate Indicator: Dissolve 5 g of sodium oxalate in 250 mL of water. Prepare a fresh solution monthly.

10.3 Sodium Hydroxide (50%): 50% solution (W/W) of sodium hydroxide is available from many laboratory supply

vendors. It can be prepared by dissolving 100 g of sodium hydroxide pellets in 100 mL of water in a polyethylene bottle. Let stand for a week to allow the insoluble sodium carbonate to settle.

10.4 pH 12.0 Buffer Solution: Dissolve 41.0 g of diethylamine hydrochloride in 400 mL of water. Add 40 mL of 50% sodium hydroxide and dilute to 500 mL. Store in a polyethylene bottle. Prepare a fresh solution monthly.

11. Procedure

11.1 Pour the specimen into a 250 mL Erlenmeyer flask and add 85 mL of water. Wash any residual chelating agent from the weighing paper or dish into the flask.

11.2 Add 5 drops of 50% sodium hydroxide (10 drops if the free acid form of a chelating agent is being analyzed) and swirl to dissolve and/or mix the chelating agent.

11.3 Add 1 mL of pH 12.0 buffer solution and swirl to mix.

11.4 Add 10 mL of sodium oxalate solution and swirl to mix.

11.5 Using a 10 mL burette, titrate with calcium titrant solution until a drop produces a slight turbidity that persists for at least 30 s (see 14.2).

12. Calculation

12.1 Calculate the calcium chelation

value (CaCV) for each specimen to three significant digits using the following equation:

$$\text{CaCV} = \frac{(100.1)(0.250)(V)}{W}$$

where:

CaCV = Calcium chelation value, expressed as mg CaCO₃/g chelating agent

100.1 = Molecular weight of CaCO₃, expressed in mg/mole

0.250 = Molarity of calcium titrant solution expressed in mmoles/mL

V = Volume of calcium titrant solution in mL

W = Weight of specimen in grams

13. Precision and Bias

13.1 *Summary.* An interlaboratory study was conducted in March 1990 to establish the precision of the test method. Four chelating agents (EDTA, tetrasodium salt; EDTA, 40% solution of tetrasodium salt; DTPA, free acid; and DTPA, 40% solution) were evaluated. Six laboratories were not used because the protocol was not strictly followed.

13.2 *Precision.* The components of variance as standard deviations of CaCV were calculated as follows:

Single Operator Component	1.46
Interlaboratory Component	0.00

13.3 *Critical Differences.* For the components of variances reported in 13.2, two averages of observed values should be considered significantly different at the 95% probability level if the difference is equal to or exceeds the following critical differences:

Single Operator	4.04
Interlaboratory	4.04

13.4 *Bias.* Based on the theoretical calcium chelation values of the four materials used in the interlaboratory study, the average bias of the five laboratories was 2.24%. The individual biases for the four materials and five laboratories ranged from 2.50%-4.25%.

14. Notes

14.1 Available from Publications Office, ACGIH, Kemper Woods Center, 1330 Kemper Meadow Dr., Cincinnati OH 45240; tel: 513/742-2020.

14.2 Turbidity is easier to observe when a piece of black paper is placed beneath and behind the flask, and the flask is illuminated from the side by a white fluorescent light. Add the calcium titrant dropwise once the turbidity begins to persist for more than 2-3 s. The endpoint is the first sign of turbidity that persists for at least 30 s. If there is uncertainty as to whether or not a slight turbidity has been obtained, compare the appearance of the flask to that of one containing only water which has a distinct clear appearance.

Dimensional Changes of Garments after Home Laundering

Developed in 1977 by AATCC Committee RA42; editorially revised and reaffirmed 1979, 1984, 1992; editorially revised 1983, 1985, 1989, 1990, 1991, 1996, 1997, 2004, 2005; revised 1987, 1995, 2001, 2003 (with title change); reaffirmed 2000. Related to ISO 3759.

1. Purpose and Scope

1.1 This test method is for the determination of dimensional changes of garments when subjected to home laundering procedures used by consumers. Four washing temperatures, three agitation cycles, two rinse temperatures and four drying procedures cover the common home care options available to consumers using current laundering machines.

1.2 The dimensional changes of garments subjected to home laundering care procedures are measured using benchmarks placed on designated areas of the garments. Measured dimensional changes may be affected by garment construction, tensions, sewing threads or trims in addition to fabric dimensional change.

1.3 As an optional procedure, fabric dimensional changes may be determined by using benchmarks placed on the fabric in areas of the garment that contains no seams or sewing.

1.4 This method may not be applicable for garments made of certain stretch fabrics.

2. Principle

2.1 The dimensional changes of garment specimens subjected to home laundering care procedures are measured using benchmarks applied to the garment before laundering.

3. Terminology

3.1 **dimensional change**, *n.*—a generic term for changes in length or width of a fabric specimen subjected to specified conditions. The change is usually expressed as a percentage of the initial dimension of a specimen.

3.2 **garment**, *n.*—a shaped article of textile fabric, or other flexible material, intended to cover portions of the human body.

3.3 **growth**, *n.*—a dimensional change resulting in an increase of length or width of a specimen.

3.4 **laundering**, *n.*—of textile materi-

als, a process intended to remove soils and/or stains by treatment (washing) with an aqueous detergent solution and normally including rinsing, extraction and drying.

3.5 **shrinkage**, *n.*—a dimensional change resulting in a decrease in the length or width of a specimen.

4. Safety Precautions

NOTE: These safety precautions are for information purposes only. The precautions are ancillary to the testing procedures and are not intended to be all inclusive. It is the user's responsibility to use safe and proper techniques in handling materials in this test method. Manufacturers MUST be consulted for specific details such as material safety data sheets and other manufacturer's recommendations. All OSHA standards and rules must also be consulted and followed.

4.1 Good laboratory practices should be followed. Wear safety glasses in all laboratory areas.

4.2 The 1993 AATCC Standard Reference Detergent may cause irritation. Care should be taken to prevent exposure to skin and eyes.

4.3 Manufacturer's safety recommendations should be followed when operating laboratory testing equipment.

5. Apparatus and Materials

5.1 Automatic washing machine (see 12.1).

5.2 Automatic tumble dryer (see 12.2).

5.3 Conditioning/drying racks with pullout screens or perforated shelves (see 12.3).

5.4 Facilities for drip drying and line drying.

5.5 1993 AATCC Standard Reference Detergent (see 12.8 and 12.9).

5.6 Ballast of 920 × 920 ± 30 mm (36 × 36 ± 1 in.) hemmed pieces of bleached cotton sheeting (Wash load ballast type 1), or 50/50 polyester/cotton bleached plain weave (Wash load ballast type 3) (see 12.4 and 12.9).

5.7 Indelible ink marking pen (see 12.5) for use with suitable rule, tape, marking template or other marking device (see 12.6). Sewing thread may be used for making benchmarks.

5.8 Measuring devices.

5.8.1 Tape or rule marked in millimeters, eighths or tenths of an inch.

5.8.2 Tape or ruled template marked directly in percent dimensional change to 0.5% or smaller (see 12.6).

5.9 Balance with at least 5.0 kg (10.0 lb) capacity.

6. Test Specimens

6.1 Sampling and Preparation.

6.1.1 Each garment will be considered a specimen. Garments used as specimens should be representative of the production lot. When possible, three specimens should be used. One or two specimens may be used when insufficient garments are available.

6.1.2 Garments that are distorted in their unlaunched state due to faulty fabric finishing, garment assembly, or packing may give deceptive dimensional change results when laundered by any procedure. In such cases, it is recommended that a garment not be tested or, if used, the results be considered as indicative only.

6.1.3 Prior to marking, condition test specimens as directed in ASTM D 1776, Standard Practice for Conditioning and Testing Textiles. Condition each garment for at least 4 h, in an atmosphere of 21 ± 1°C (70 ± 2°F) and 65 ± 2% RH by hanging it on an appropriate hanger. If the garment would not normally be hung on a hanger; i.e., t-shirts, boxer shorts, etc., lay each test specimen separately on a screen or perforated shelves of a conditioning rack.

6.2 Marking.

6.2.1 Using Table I as a guide for the selection of garment specimen areas to use as measurement sites, place benchmarks on the garment at the selected locations. Use at least three length and three width locations for marking benchmarks on each garment specimen. Location of benchmarks should be as agreed upon by the buyer and seller. If garment areas are sufficient, place 460 mm (18 in.) benchmarks on the garment. Benchmark distances used will depend on the size of the garment. For some garments, especially children's clothing, sufficient area may require shorter benchmarks such as 250 mm (10.0 in) or less. Benchmarks must be at least 25 mm (1 in.) from all edges or seams.

6.2.2 Benchmarks across garment panels are sometimes used such as, from side seam-to-side seam, the full length or width of a garment and in other selected garment locations. For these types of benchmarks, the measurement points should be clearly marked.

6.2.3 Dimensional change results from different garment sizes, styles and/or

Table I—Examples of Bench Mark Locations

Type of Garment	Bench Mark Locations
Shirt	Collar Collar Band Body Lengths Sleeve Lengths Width at Chest Cuffs
Trousers	Front Rise Back Rise Inseams Outseams Waist Seat
Coveralls	Body Lengths Front Rise Back Rise Inseams Underarm Lengths Sleeve Lengths Shoulder Waist Chest Seat Width
Boxer Shorts	Overall Lengths Front Rise Back Rise Waist
Pajama Top	Lengths Sleeves Hem Chest
Pajama Bottom	Inseams Lengths Hip Waist
Shorts	Lengths Front Rise Back Rise Leg Width Inseam Width Seat Width Waist
Sweater	Lengths Sleeve Lengths Chest Waist Shoulders
Slip	Lengths Hem Waist Hip
Blouse	Lengths Sleeve Lengths Shoulders Chest Waist
Skirt	Lengths Hem Hip Waist
Uniform/Dress	Bodice Lengths Skirt Lengths Sleeve Lengths Shoulders Chest Waist Hip Hem
Overalls	Lengths Outseams Front Rise Back Rise Inseams Waist Seat Width

benchmark lengths may not be comparable.

6.2.4 Benchmark distances used should be indicated on the report.

6.3 Original Measurements.

6.3.1 To improve the accuracy and precision of the dimensional change calculations based on the benchmarks applied to the garment in 6.2, measure and record the distance between each pair of benchmarks with suitable tape or rule to nearest millimeter or eighth or tenth of an inch. This is measurement A.

7. Test Procedure

7.1 Tables II, III and IV summarize alternative washing, rinsing and drying conditions and settings. Additional information on the machine and laundering conditions may be found in the monograph, *Standardization of Home Laundry Test Conditions*, elsewhere in this TECHNICAL MANUAL.

7.2 Washing.

7.2.1 Weigh garment test specimens and enough ballast to make a 1.8 ± 0.1 kg (4.00 ± 0.25 lb) load. An alternative load size of 3.6 ± 0.1 kg (8.00 ± 0.25 lb) may be used. Dimensional change results obtained using a 1.8 kg (4 lb) load weight may not be equal to those obtained with a 3.6 kg (8 lb) load weight and should not be compared.

7.2.2 Select the specified water level, the desired water temperature for the

washing cycle and a rinse temperature of less than 29°C (85°F). If this rinse temperature is not attainable, record available rinse temperature. Fill the washing machine to the 18 ± 0.5 gal water level. For alternate load size, fill washing machine to the 22.0 ± 0.5 gal water level.

7.2.3 Add 66.0 ± 1 g of 1993 AATCC Standard Reference Detergent to an 18 ± 0.5 gal wash load. For alternative load size of 22.0 ± 0.5 gal, add 80 ± 1 g of 1993 AATCC Standard Reference Detergent. Agitate water briefly to dissolve detergent. Stop the machine agitation. It should be noted that in soft water areas, the amount of detergent used may be reduced to avoid excessive sudsing.

7.2.4 Add garment test specimens and ballast to machine. Set the washer for the selected washing cycle and time (see Tables II and III).

7.2.5 For garment specimens to be dried by procedures A, B or D, allow washing to proceed through the final spin cycle. Remove the garment specimens immediately after the final spin cycle, separate tangled garments, taking care to minimize distortion, and dry by procedure A, B or D (see Tables II and IV).

7.2.6 For garment specimens to be dried by procedure C, Drip Dry, allow washing to proceed through to the final rinse cycle. Remove the specimens from the washer just before the water begins to drain for the final rinse cycle. Remove specimens soaking wet.

Table II—Alternative Washing and Drying Conditions (see 7.1)

Machine Cycle	Washing Temperatures	Drying Procedures
(1) Normal/Cotton Sturdy	(II) 27 ± 3°C (80 ± 5°F)	(A) Tumble:
(2) Delicate	(III) 41 ± 3°C (105 ± 5°F)	i. Cotton Sturdy
(3) Permanent Press	(IV) 49 ± 3°C (120 ± 5°F)	ii. Delicate
	(V) 60 ± 3°C (140 ± 5°F)	iii. Permanent Press
		(B) Line
		(C) Drip
		(D) Screen

Table III—Washing Machine Setting Conditions Without Load (see 7.1)

	Normal	Delicate	Permanent Press
(A) Water Level	18 ± 1 gal	18 ± 1 gal	18 ± 1 gal
(B) Agitator Speed	179 ± 2 spm	119 ± 2 spm	179 ± 2 spm
(C) Washing Time	12 min	8 min	10 min
(D) Spin Speed	645 ± 15 rpm	430 ± 15 rpm	430 ± 15 rpm
(E) Final Spin Cycle	6 min	4 min	4 min

Table IV—Dryer Setting Conditions (see 7.1)

	Cotton Sturdy	Delicate	Permanent Press
Exhaust Temperature	High 66 ± 5°C (150 ± 10°F)	Low < 60°C (140°F)	High 66 ± 5°C (150 ± 10°F)
Cool Down Time	10 min	10 min	10 min

7.3 Drying.

7.3.1 For drying procedures B, C and D do not blow air directly on specimens as it may cause fabric distortion within the garment.

7.3.2 (A) Tumble Dry. Place the washed load (garment test specimens and ballast) in the tumble dryer, and set the temperature control to generate the correct exhaust temperatures as specified in Table IV. For fibers that are heat sensitive, lower temperatures consistent with producer's care recommendations should be used and reported. Allow the dryer to operate until the total load is dry. Remove the load immediately after the dryer stops.

7.3.3 (B) Line Dry. Hang each garment on an appropriate hanger, straightening and smoothing facings, seams, etc. Allow the garment to hang in still air at room temperature, not greater than 26°C (78°F) until dry.

7.3.4 (C) Drip Dry. Hang each dripping garment on an appropriate hanger, straightening and smoothing facings, seams, etc. Allow the specimens to hang in still air at room temperature, not greater than 26°C (78°F) until dry.

7.3.5 (D) Screen Dry. Spread each garment on a horizontal screen or perforated surface removing wrinkles without distorting or stretching it. Allow the specimen to dry in still air at room temperature, not greater than 26°C (78°F).

7.3.6 Repeat the selected washing and drying cycle two more times or to an agreed number of cycles.

7.4 Conditioning and Restoration.

7.4.1 After the last washing and drying cycle, garments must be conditioned before being remeasured. All garments need to be completely dry before they are conditioned. Condition garments (see 6.1.3) for at least 4 h by hanging each completely dry garment on a hanger or by laying each completely dry garment separately on a screen or perforated shelf of a conditioning rack in an atmosphere at $21 \pm 1^\circ\text{C}$ ($70 \pm 2^\circ\text{F}$) and $65 \pm 2\%$ RH.

7.4.2 For garments that are intended to be used as a form fitting garment, a restoration technique is sometimes used prior to determining the dimensional change. Techniques for this type of restoration are not standardized (hand pulling a garment in length and width directions using an unspecified force). If restoration techniques are used, a description of the technique should be reported and the results should be reported as restored dimensional change.

7.4.3 If garments are extremely wrinkled and the consumer would ALWAYS expect to iron the garment before using, the garments may be ironed prior to remeasurement of the distance between benchmarks. Use safe ironing temperatures appropriate to the fibers in the fab-

ric being ironed. See Table I, Safe Ironing Temperature Guide, in AATCC Method 133, Colorfastness to Heat: Hot Pressing. Exert only that pressure during pressing which is necessary to remove wrinkles.

7.4.3.1 Due to the extremely high variability of hand ironing procedures performed by individual operators (no standard test method exists for hand ironing procedures), the reproducibility of dimensional change results after hand ironing has been found to be extremely poor. Consequently, caution is advised when comparing dimensional change results after laundering and hand ironing, reported by different operators.

7.4.3.2 Hand ironing, is intended primarily for the evaluation of fabrics used in garments, which require ironing to remove wrinkles prior to wearing. Use safe ironing temperatures appropriate to the fibers in the fabric being ironed. See Table I, Safe Ironing Temperature Guide, in AATCC Method 133, Colorfastness to Heat: Hot Pressing. Exert only that pressure during pressing which is necessary to remove wrinkles.

7.4.3.3 After ironing, condition garments for at least 4 h (see 6.1.3) by hanging each garment on a hanger or by laying each specimen separately on the screen or perforated shelf of a conditioning rack in an atmosphere at $21 \pm 1^\circ\text{C}$ ($70 \pm 2^\circ\text{F}$) and $65 \pm 2\%$ RH.

8. Measurement

8.1 After conditioning, lay each garment without tension on a flat smooth, horizontal surface. Measure and record the distance between benchmarks or between marks made across garment panels such as, from side seam-to-side seam, the full length or width of a garment and other selected garment locations, to the nearest millimeter, or eighth or tenth of an inch. This is measurement B. Or, if using a scale calibrated in percent dimensional change, measure to nearest 0.5% or smallest increment on the scale and record the percent dimensional change directly.

9. Calculation and Interpretation

9.1 Calculation.

9.1.1 If measurements were made directly in percent dimensional change, average the measurements in each location made on the test garments after the first, the third, or other specified number of washing and drying cycles.

9.1.2 If measurements were made to the nearest millimeter, or eighth or tenth of an inch (measurement B), calculate the dimensional change after the first and, the third or other specified washing and drying cycle as follows:

$$\% DC = 100 (B - A)/A$$

where:

DC = Dimensional change

A = Original dimension

B = Dimension after laundering

Average the dimensional change for each measurement location made on all test garments. If desired, calculate length and width averages separately to nearest 0.1% (12.7).

9.1.3 A final measurement smaller than the original measurement results in a negative dimensional change which is shrinkage. A final measurement larger than the original measurement results in a positive dimensional change which is growth.

9.2 Interpretation.

9.2.1 If the dimensional change after one washing and drying cycle as calculated in 9.1, is within a specification previously agreed on, continue test procedure as directed in 7.2, 7.3 and 7.4 until an agreed upon number of cycles has been completed.

9.2.2 If the dimensional change after one washing, drying, and, if used, hand ironing cycle as calculated in 9.1 exceeds a specification previously agreed on, terminate the test.

10. Report

10.1 Report for each sample test:

(a) Dimensional change, length and width for each garment locations (i.e. body length, sleeve length, body width, collar width) to the nearest 0.1% with a minus sign (-) for shrinkage or a plus (+) sign for growth (see 9.1.3).

(b) Washing procedure (include type of washing, cycle and temperature) and drying procedure (include type of drying, cycle and temperature).

(c) Size of load; i.e., 1.8 kg (4 lb) or 3.6 kg (8 lb).

(d) Number of complete washing and drying cycles (see 9.2.1).

(e) If garments are distorted in unlaundered state.

(f) If garments were hand ironed.

(g) If garments were restored and a restoration technique.

11. Precision and Bias

11.1 *Precision.* Precision for this test method has not been established. Until a precision statement is generated, use standard statistical techniques in making any comparisons of test results for either *within-laboratory* or *between-laboratory* averages.

11.2 *Bias.* Dimensional changes in automatic home laundering of garments can be defined only in terms of a test method. There is no independent method for determining the true value. As a means of estimating this property, the method has no known bias.

12. Notes

12.1 Contact AATCC, P.O. Box 12215, Research Triangle Park NC 27709; tel: 919/ 549-8141; fax: 919/549-8933; e-mail: orders@aatcc.org, for model number(s) and source(s) of current approved washer(s). Any other washer, which is known to give comparable results, can be used. Washing machine conditions given in Table III represent the actual speeds and times available on the current specified model(s). Other washers may vary in one or more of these settings.

12.2 Contact AATCC, P.O. Box 12215, Research Triangle Park NC 27709; tel: 919/ 549-8141; fax: 919/549-8933; e-mail: orders@aatcc.org, for model number(s) and source(s) of current approved dryer(s). Any other dryer which is known to give comparable results can be used. Dryer machine conditions given in Table IV represent the actual temperatures and cool-down times available on the current specified model(s). The dryers may vary in one or more of these settings.

12.3 Screen or perforated conditioning/drying racks available from Somers Sheet Metal Inc., 5590 N. Church St., Greensboro NC 27405; tel: 336/643-3477; fax: 336/643-7443.

Rack drawings available from AATCC, P.O. Box 12215, Research Triangle Park NC 27709; tel: 919/549-8141; fax: 919/549-8933; e-mail: orders@aatcc.org.

12.4 Ballast are available from Testfabrics Inc., P.O. Box 26, 415 Delaware St., W. Pittston PA 18643; tel: 570/603-0432; fax: 570/603-0433; and Textile Innovators Corp., div. of SDL Atlas L.L.C., P.O. Box 8, 101 Forest St., Windsor NC; tel: 252/794-9703; fax: 252/794-9704; e-mail: tic@sdlatlas.com.

12.5 Marking pens with different size tips are available from Mark-Tex Corp., Box 681, Englewood NJ 07631; and AATCC, P.O. Box 12215, Research Triangle Park NC 27709; tel:919/549-8141; fax: 919/549-8933; e-mail: orders@aatcc.org.

12.6 A ruled template marked in percent dimensional change is available from AATCC, P.O. Box 12215, Research Triangle Park NC 27709; tel: 919/549-8141; fax: 919/549-8933; e-mail: orders@aatcc.org. A mechanical marking device and measuring tape marked in percent dimensional change is available from The Sanforized Co., 3200 Highlands Pkwy., Suite 300, Smyrna GA 30082; tel: 770/803-7662.

12.7 If information on the dimensional

change variability between specimens is needed, calculate dimensional change based on the individual pairs of benchmarks.

12.8 Available from AATCC, P.O. Box 12215, Research Triangle Park NC 27709; tel:919/549-8141; fax: 919/549-8933; e-mail: orders@aatcc.org.

12.9 The AATCC Technical Center conducted a study to compare the 1993 AATCC Standard Reference Detergent, AATCC Standard Reference Detergent 124 and two different types of fabrics (current and proposed) to be used as ballast, under the following test conditions:

Machine cycle: (1)—Normal/Cotton
Sturdy
Washing Temp: (V)—60 ± 3°C (140 ± 5°F)
Drying Procedure: (A)i—Tumble dry, cotton
sturdy cycle
Fabrics tested: White Twill (100% cotton)
Beige Twill (100% cotton)
Grey Poplin (100% cotton)
Blue Twill (50/50 poly/
cotton)

No significant differences were found in the results using either detergent or ballast load fabrics.

Soil Redeposition: Launder-Ometer Method

Developed in 1977 in AATCC Committee RA56; reaffirmed 1980, 2003; editorially revised and reaffirmed 1985, 1990; editorially revised 1986, 1991, 1995, 2004; revised (with title change) 1998.

1. Purpose and Scope

1.1 This laboratory test method measures the degree of soil redeposition which may occur on a fabric during the laundering process and is applicable to any light-colored fabric.

1.2 The test method includes two means of demonstrating the soil redeposition performance of most fabrics. In the past, a single 30 min cycle produced a level of soil redeposition that correlated well with 100 home launderings (see 12.1). Three 10 min cycles can be used to produce an exaggerated soil level for a quick and effective way to demonstrate differences between fabrics.

2. Principle

2.1 Test specimens are exposed to a soiling medium in a Launder-Ometer canister under specified conditions and its change in *Y* value (CIE standard illuminant D_{65} and 1964 10° observer) is measured using a spectrophotometer or colorimeter. AATCC Evaluation Procedure 6, Instrumental Color Measurement, can be used for reference.

3. Terminology

3.1 **soil affinity**, *n.*—the reduction in *Y* value between new and soiled fabrics.

3.2 **soil redeposition**, *n.*—the soiling of clean or relatively clean fabric during the laundering process by soil which has been removed from another fabric.

3.3 **wet soiling**, *n.*—the application of soil from a liquid medium.

4. Safety Precautions

NOTE: These safety precautions are for information purposes only. The precautions are ancillary to the testing procedures and are not intended to be all inclusive. It is the user's responsibility to use safe and proper techniques in handling materials in this test method. Manufacturers MUST be consulted for specific details such as material safety data sheets and other manufacturer's recommendations. All OSHA standards and rules must also be consulted and followed.

4.1 Follow good laboratory practices.

Wear safety glasses in all laboratory areas.

4.2 All chemicals should be handled with care.

4.3 The 1993 AATCC Standard Reference Detergent may cause irritation. Care should be taken to prevent exposure to skin and eyes.

4.4 Perchloroethylene is toxic by inhalation, by repeated contact with skin and by ingestion; it should be used only in a well vented atmosphere. Toxicology studies with laboratory animals have shown evidence of cancer in rats and mice exposed to perchloroethylene vapors at 100-400 ppm concentrations for prolonged times. Fabric saturated with this solvent should be dried in an adequately ventilated hood. Use chemical goggles or face shield, impervious gloves and an impervious apron when handling perchloroethylene.

4.5 An eyewash/safety shower should be located nearby and an organic vapor respirator should be readily available for emergency use.

4.6 Exposure to chemicals used in this procedure must be controlled at or below levels set by governmental authorities [e.g., Occupational Safety and Health Administration's (OSHA) permissible exposure limits (PEL) as found in 29 CFR 1910.1000 of January 1, 1989]. In addition, the American Conference of Governmental Industrial Hygienists (ACGIH) Threshold Limit Values (TLVs) comprised of time weighted averages (TLV-TWA), short term exposure limits (TLV-STEL) and ceiling limits (TLV-C) are recommended as a general guide for air contaminant exposure which should be met (see 12.2).

5. Apparatus and Materials

5.1 Launder-Ometer (see 12.3).

5.2 Canisters, stainless steel, 80 × 130 ± 5 mm (3 × 5 ± 0.2 in.), with solvent resistant seals (see 12.3).

5.3 Balls, stainless steel, 6 mm (0.25 in.) diameter (see 12.3).

5.4 Colorimeter or spectrophotometer (see 12.4).

5.5 Automatic home dryer (see 12.5).

5.6 Particulate soil.

5.6.1 Bandy Black clay (see 12.6).

5.6.2 Vacuum cleaner dirt (see 12.7).

5.7 Beakers, glass, 50 mL, 1500 mL and 4000 mL.

5.8 Tweezers, 250-300 mm (10-12 in.) in length.

5.9 Syringe, 1 mL tuberculin.

5.10 Cotton swatches, bleached sheeting cut into at least 50 × 50 mm (2 × 2 in.) (see 12.8).

5.11 Screen, 150 mesh (Tyler equivalent).

6. Reagents

6.1 Water with a hardness of 150 ± 5 ppm (9 gr) (see 12.9). The use of deionized or distilled water is preferred.

6.2 Hardness concentrate for artificially hardening the water (see 12.10).

6.3 1993 AATCC Standard Reference Detergent (see 12.11).

6.4 Triolein, technical oil ($C_{57}H_{104}O_6$, FW 885.46) (see 12.12).

6.5 Mineral oil, Saybolt Viscosity 180-190 (see 12.13).

6.6 Perchloroethylene ($CHCl_2CHCl_2$).

6.7 Magnesium chloride, hexahydrate ($MgCl_2 \cdot 6H_2O$).

6.8 Calcium chloride, anhydrous ($CaCl_2$).

7. Preparation of Oil-Soiled Swatches

7.1 Preparation of oily soil.

7.1.1 Weigh 6.25 ± 0.5 g of triolein and 6.25 ± 0.5 g of mineral oil.

7.1.2 Dilute with 50 ± 2 mL of perchloroethylene. Oily soil will remain stable under refrigeration at 4°C (40°F).

7.2 Place each of the four 50 × 50 mm (2 × 2 in.) cotton swatches over the mouth of small glass beakers.

7.3 Apply 0.2 mL of the oily soil prepared in 7.1 to the center of each swatch using a 1 mL tuberculin syringe.

7.4 Dry swatches flat to avoid dripping and uneven distributions of the oil into the swatches. Allow swatches to condition for 1 h in ambient conditions prior to use.

7.5 Prepare fresh oily soiled swatches daily.

8. Test Specimens

8.1 Cut four specimens from each fabric to be tested into 100 × 200 mm (4 × 8 in.) swatches. The 100 mm (4 in.) dimension is the length and the 200 mm (8 in.) dimension is the width of the fabric. Do not have same lengthwise or widthwise yarns in any two specimens. Do not take specimens within 10% of the selvedge of the fabric. Pre-washing or stripping the specimens before testing is recommended.

9. Procedures

9.1 Initial *Y* Value (Tristimulus Re-

flectance).

9.1.1 Fold each specimen with the face side out, to obtain a 100 mm (4 in.) square.

9.1.2 Stack the four folded test specimens to obtain eight thicknesses.

9.1.3 Using a calibrated colorimeter or spectrophotometer, make a total of 16 readings, presenting the specimen stack as directed in 9.1.3.1-9.1.3.3.

9.1.3.1 Read and record the Y value of the top and bottom of the specimen stack to the nearest 0.1.

9.1.3.2 Move specimen one to the bottom of the stack. Read the Y value of the top and bottom of the new stack, continue moving the top specimen to the bottom of the stack and reading the Y value of the top and the bottom of the stack until specimen four is at the top of the stack and 8 Y value readings have been taken.

9.1.3.3 Rotate the specimens 90° and repeat the readings as in 9.1.3.2 for eight more Y value readings.

9.1.3.4 Calculate the average of the 16 readings to the nearest 0.1 and record as the initial Y value (Y_I).

9.2 Soiling treatment.

9.2.1 Pre-heat the Launder-Ometer to $54 \pm 2^\circ\text{C}$ ($130 \pm 5^\circ\text{F}$).

9.2.2 Place 30 steel balls in each of the 20 stainless steel canisters.

9.2.3 Measure 4 L of soft water at $54 \pm 2^\circ\text{C}$ ($130 \pm 5^\circ\text{F}$) into a beaker.

9.2.4 Transfer 70 ± 0.15 mL of hardness concentrate into the beaker and stir for 30 s.

9.2.5 Add 200 ± 0.4 mL of the hard water (150 ± 5 ppm) to each of the stainless steel canisters.

9.2.6 Add 0.20 ± 0.01 g of 1993 AATCC Standard Reference Detergent into each of the stainless steel canisters.

9.2.7 Add 0.25 ± 0.01 g each of the two particulate soils, Bandy Black clay and vacuum cleaner dirt, to each canister.

9.2.8 Add two oily soiled carrier cotton swatches to each canister.

9.2.9 Add one test specimen to each canister. Close the canisters. Be sure to use solvent resistant seals. Place canisters into the Launder-Ometer.

9.3 Running time.

9.3.1 Choose one of the three run cycles as described below:

9.3.1.1 For Option 1, run one cycle for 10 min in the Launder-Ometer at $54 \pm 2^\circ\text{C}$ ($130 \pm 5^\circ\text{F}$).

9.3.1.2 For Option 2, run the 10 min cycle for a total of three times for the exaggerated soil level.

9.3.1.3 For Option 3, run a 30 min cycle in the Launder-Ometer at $54 \pm 2^\circ\text{C}$ ($130 \pm 5^\circ\text{F}$) for the level of soil that correlated best with 100 home launderings (see 12.1).

9.4 Rinsing and drying.

9.4.1 Remove a test specimen with tweezers. Rinse the specimen by dipping it ten times in each of three successive beakers of soft water at $20 \pm 5^\circ\text{C}$ ($70 \pm 10^\circ\text{F}$) for a total of 30 dips. Replace the rinse water after the four replicates of each test fabric are rinsed. Repeat for each of the remaining specimens of the sample.

9.4.2 Squeeze excess water from specimens by hand and tumble dry on the normal setting.

9.5 Fold, stack and read the Y values of the soiled test specimens as directed in 9.1.3. Calculate the average of the 16 readings to the nearest 0.1 and record as the soiled Y value (Y_F).

10. Calculation and Report

10.1 Calculate the soiling affinity using the following equation:

$$S = Y_I - Y_F$$

where:

S = Soiling affinity

Y_I = Initial, or unsoiled, Y value reading

Y_F = Final, or soiled, Y value reading

10.2 Report the following:

10.2.1 Description of the material tested.

10.2.2 Run cycle option used.

10.2.3 Water hardness.

10.2.4 Soiling affinity for each sample.

11. Precision and Bias

11.1 Precision.

11.1.1 The precision of this test method has not been established. Until a precision statement is generated, use standard statistical techniques in making any comparisons of test results for either *within-laboratory* or *between-laboratory* averages.

11.2 Bias.

11.2.1 There is no independent referee test method for measuring the true value of soil redeposition to determine any bias in this test method. There is no known bias.

12. Notes

12.1 The correlation tests referred to have utilized the AATCC approved washer (contact AATCC, P.O. Box 12215, Research Triangle Park NC 27709; tel: 919/549-8141; fax: 919/549-8933; e-mail: orders@aatcc.org, for the list of approved washers), Permanent Press or Durable Press Cycle, 37°C (100°F) wash temperature, 100 g of detergent, 64.6 L (17 gal) water, 120 ppm water hardness, 2.7 kg (6.0 lb) of test fabrics [0.68 kg (1.5 lb) clean fabric and 2.0 kg (4.5 lb) naturally soiled dirty clothes]. The items were tumble dried after each wash cycle and cold rinse. Instrumental readings were taken after 25, 50 and 100 cycles. A test fabric specimen of 350×350 mm

(14×14 in.) was used.

12.2 Available from Publications Office, ACGIH, Kemper Woods Center, 1330 Kemper Meadow Dr., Cincinnati OH 45240; tel: 513/742-2020.

12.3 Available from SDL Atlas L.L.C., 1813A Associate Lane, Charlotte NC 28217; tel: 704/329-0911; fax: 704/329-0914; e-mail: info@sdlatlas.com.

12.4 Suitable apparatus: Hunterlab Model D25 (A, M or L) Colorimeter (gives Y values) available from the Hunter Associates Laboratory Inc., 11491 Sunset Hills Rd., Reston VA 20190; tel: 703/471-6870. Other instruments may be used as long as the values reported are Y values (See AATCC Evaluation Procedure 6).

12.5 Contact AATCC, P.O. Box 12215, Research Triangle Park NC 27709; tel: 919/549-8141; fax: 919/549-8933; e-mail: orders@aatcc.org, for model number(s) and source(s) of approved dryers. Any other dryer which is known to give comparable results can be used.

12.6 Available from Textile Innovators Corp., div. of SDL Atlas L.L.C., P.O. Box 8, 101 Forest St., Windsor NC; tel: 252/794-9703; fax: 252/794-9704; e-mail: tic@sdlatlas.com.

12.7 Vacuum cleaner dirt can be obtained from domestic or office locations. Before use, screen the dirt through a 150-mesh (Tyler equivalent) screen to remove lint, trash and coarse particles. It can also be purchased from Textile Innovators Corp., div. of SDL Atlas L.L.C., P.O. Box 8, 101 Forest St., Windsor NC; tel: 252/794-9703; fax: 252/794-9704; e-mail: tic@sdlatlas.com.

12.8 A bleached cotton sheeting is suggested for the oily soiled swatches. A suitable fabric identified as Style 405 is available from Testfabrics Inc., P.O. Box 26, 415 Delaware St., W. Pittston PA 18643; tel: 570/603-0432; fax: 570/603-0433; e-mail: testfabric@aol.com, and Textile Innovators Corp., div. of SDL Atlas L.L.C., P.O. Box 8, 101 Forest St., Windsor NC; tel: 252/794-9703; fax: 252/794-9704; e-mail: tic@sdlatlas.com.

12.9 In special circumstances, water with a 0 ppm and 300 ppm hardness may be used to simulate an unusual situation.

12.10 Make hardness concentrate as follows:

12.10.1 Chemicals. Magnesium chloride hexahydrate ($\text{MgCl}_2 \cdot 6\text{H}_2\text{O}$); calcium chloride, anhydrous, (CaCl_2); softened water.

12.10.2 Procedure. In a glass container mix 13.114 ± 0.001 g magnesium chloride hexahydrate with 1 L of soft water with constant stirring. Add 2.356 ± 0.001 g of calcium chloride, anhydrous, slowly to keep heat generation to a minimum. Agitate a total of 30 min. The concentrate strength is equal to 34 ppm/mL or 2 gr/mL) water hardness.

12.11 The 1993 AATCC Standard Reference Detergent is available from AATCC, P.O. Box 12215, Research Triangle Park NC 27709; tel: 919/549-8141; fax: 919/549-8933; e-mail: orders@aatcc.org.

12.12 Triolein technical oil ($\text{C}_{57}\text{H}_{104}\text{O}_6$, FW 885.46) is available from Sigma Chemical Co., P.O. Box 14508, St. Louis MO 63178. The practical grade is catalog no. T7752.

12.13 Mineral oil is available from any division of The Standard Oil Co. Identify it as white mineral oil, USP 185.

Thermal Fixation Properties of Disperse Dyes

Developed in 1978 by AATCC Committee RA87; reaffirmed 1981; editorially revised and reaffirmed 1986, 1991, 1996, 2001.

1. Purpose and Scope

1.1 This test method is used to determine the fixation properties of disperse dyes on polyester/cellulose blends as a function of fixation conditions. The variable described herein is temperature; however, variations in time and/or concentration of dyes and/or auxiliaries may be studied by this method.

2. Principle

2.1 The dye is padded onto the blend fabric at a specified concentration; the fabric is dried and the dye is fixed by exposure to controlled conditions of time and temperature. The cotton portion of the blend is dissolved in concentrated sulfuric acid followed by neutralization and thorough rinsing.

2.2 The reflectance values of the dyed fabrics, exposed to the several fixation conditions, are determined by spectrophotometry and the concentrations of dye relative to the heaviest dyeing (as 100%) are evaluated by applying the Kubelka-Munk function (K/S). These results express the relative dye fixation for a particular set of dyeing conditions. Alternatively, the dye on the fabric can be extracted with a suitable solvent and the concentrations of dye determined by transmittance spectrophotometry. When the dye concentrations on the fixed samples are compared to the corresponding concentration on a padded but *unfixed* sample, a measure of the true dye fixation, as a function of applied dye, may be obtained.

3. Terminology

3.1 **disperse dye**, n.—an essentially water insoluble dye having affinity, when properly dispersed, for polyester, polyamide and some other manufactured polymeric fibers.

3.2 **thermal fixation**, n.—the use of dry heat to achieve a degree of permanence when applying colorants to textile materials.

4. Safety Precautions

NOTE: These safety precautions are for information purposes only. The precautions are ancillary to the testing procedure

and are not intended to be all inclusive. It is the user's responsibility to use safe and proper techniques in handling materials in this test method. Manufacturers MUST be consulted for specific details such as material safety data sheets and other manufacturer's recommendations. All OSHA standards and rules must also be consulted and followed.

4.1 Good laboratory practices should be followed. Wear safety glasses in all laboratory areas.

4.2 All chemicals should be handled with care.

4.3 Perform leaching procedure (see 7.3) using sulfuric acid, 70%, in a hood. In preparing, dispensing and handling sulfuric acid, use chemical goggles or face shield, impervious gloves and an impervious apron. Concentrated acids should be handled only in an adequately ventilated hood. CAUTION: Always add acid to water.

4.4 In preparing, dispensing and handling ammonium hydroxide, use chemical goggles or face shield, impervious gloves and an impervious apron. Dispense, mix and handle ammonium hydroxide only in an adequately ventilated hood.

4.5 Perform the extraction procedure (see 8.2) using chlorobenzene inside an adequately ventilated hood. CAUTION: Chlorobenzene vapors are toxic and flammable.

4.6 Chlorobenzene is a flammable liquid and should be stored in the laboratory only in small containers away from heat, open flame and sparks.

4.7 An eyewash/safety shower should be located nearby and a self-contained breathing apparatus should be readily available for emergency use.

4.8 Exposure to chemicals used in this procedure must be controlled at or below levels set by governmental authorities (e.g., Occupational Safety and Health Administration's [OSHA] permissible exposure limits [PEL] as found in 29 CFR 1910.1000 of January 1, 1989). In addition, the American Conference of Governmental Industrial Hygienists (ACGIH) Threshold Limit Values (TLVs) comprised of time weighted averages (TLV-TWA), short term exposure limits (TLV-STEL) and ceiling limits (TLV-C) are recommended as a general guide for air contaminant exposure which should be met (see 11.1).

5. Uses and Limitations

5.1 Evaluations by reflectance mea-

surements are limited to relatively low dye concentrations because of the non-linearity of the K/S function at high dye concentrations (see 11.2).

5.2 Fixation values obtained by reflectance measurements can differ from those determined by extraction techniques because of differences in dye distribution within the fiber (see 11.2).

5.3 Every effort should be made during padding, drying and fixation to avoid two-sided dyeings. Should this occur to any significant extent, the preferred method of measuring fixation is extraction.

6. Apparatus and Materials

6.1 Laboratory padder.

6.2 Forced air thermofixation unit (see 11.1).

6.3 Analytical balance.

6.4 Spectrophotometer (see 11.3).

6.5 Volumetric pipettes and flasks.

6.6 65/35 polyester/cotton fabric; e.g., Testfabrics Inc.'s Style 7409 or equivalent fabric adequately pre-scoured and ready for dyeing (see 11.4).

6.7 Sulfuric acid, 70%.

6.8 Chlorobenzene.

6.9 Ammonium hydroxide, 5%.

6.10 Acetic acid, 56%.

7. Procedure

7.1 Pad polyester/cotton blend cloth at 50-60% wet pickup with:

10 g/L—Disperse dye

20 g/L—Antimigrant (see 11.5)

Acetic acid (56%) to pH 5.5-6.0

Use the same pad liquor for all the dyeings in the set.

7.2 Dry each sample thoroughly under minimum migration conditions (see 11.5), then thermofix for 90 s at 196°C (385°F), 205°C (400°F), 213°C (415°F) and 221°C (430°F), respectively, in a properly calibrated oven (see 11.6).

7.3 Leach out the cotton portion of the blend with 70% sulfuric acid for 3-4 min at 55°C (130°F). Rinse the sample in cold running water and neutralize with 5% ammonium hydroxide solution for 1 min followed by another cold water rinse.

7.4 In cases where a change in shade of a disperse dye is suspected due to leaching, the following procedure may be employed: Attach a 100% polyester rider to the blended cloth to be dyed by the method in 7.1. Leach a portion of the rider separately by the method described in 7.3 and evaluate for any changes that may occur in the leaching process.

8. Evaluation

8.1 Make reflectance measurements in the visible portion of the spectrum (see 11.2) to determine relative strengths on the leached polyester using the deepest dyeing fixed at 221°C (430°F) as 100%. K/S values of the minimum reflectance value are obtained using the Kubelka-Munk equation:

$$K/S = (1 - R)^2/2R$$

where:

K/S = absorption function

R = minimum reflectance value (see 11.2)

Calculate the relative fixation values in comparison to the deepest dyeing using the following equation:

$$C_i = 100 \times \frac{(K/S)_i}{(K/S)_{max}} \quad (\text{see 11.2})$$

where:

C_i = percent of dye fixed on sample i

$(K/S)_i$ = absorption function of dyeing i

$(K/S)_{max}$ = absorption function of the deepest dyeing

8.2 As an alternate method of evaluation, an accurately weighed sample (250 mg) may be individually extracted in several small portions of chlorobenzene at the boil (132°C or 270°F). When the dye is completely removed from the substrate, transfer the extract quantitatively to a volumetric flask and dilute with additional chlorobenzene (see 11.7). Transmittance measurements made at the point of minimum transmittance or maximum absorption in the visible area of the spectrum of the extracts of fixed samples are compared to the corresponding measurements of extracts of the padded, unfixed sample (as 100%). Transmittance values

are converted to absorbance values from tables (see 11.8) or as follows:

$$A = \log_{10} (1/T)$$

where:

A = the absorbance value

T = the transmittance value

Fixation values are calculated by the following equation:

$$C_i = 100 \times \frac{A_i}{A_u} \quad (\text{see 11.9})$$

where:

C_i = percent of dye fixed on sample i

A_i = absorbance of the extract of dyeing i

A_u = absorbance of the extract of the unfixed dyeing

9. Report

9.1 Fixation data obtained by the above methods may be presented in graphic form or in tabular form expressed as the percent of fixation versus temperature. The effects of the time and/or dye concentration may be shown as a family of curves depending upon the objectives of the particular study under consideration.

10. Precision and Bias

10.1 *Precision*. Precision for this test method has not been established. Until a precision statement is generated, use standard statistical techniques in making any comparisons of test results for either *within-laboratory* or *between-laboratory* averages.

10.2 *Bias*. The thermal fixation property of a disperse dye can be defined only in terms of a test method. There is no independent method for determining the true value. As a means of estimating this property, the method has no known bias.

11. Notes

11.1 Available from Publications Office, ACGIH, Kemper Woods Center, 1330 Kemper Meadow Dr., Cincinnati OH 45240; tel: 513/742-2020.

11.2 Refer to AATCC Evaluation Procedure 6, Instrumental Color Measurement, paragraph 4.3, Color Strength Value Using Reflectance Measurement, and 4.5, Relative Strength, available from AATCC Technical Center, P.O. Box 12215, Research Triangle Park NC 27709; tel: 919/549-8141; fax: 919/549-8933; e-mail: orders@aatcc.org.

11.3 A continuous or abridged reflectance spectrophotometer is suitable for measurements at the wavelength of maximum absorption (minimum reflectance).

11.4 Available from Testfabrics Inc., P.O. Box 26, 415 Delaware St., W. Pittston PA 18643; tel: 570/603-0432; fax: 570/603-0433; e-mail: testfabric@aol.com.

11.5 A number of suitable gums for this purpose are available; e.g., natural gums, alginates and synthetic acrylic acid polymers. The use of electrolytes in the pad liquor is to be avoided since the resulting agglomeration is very difficult to control.

11.6 Several fixation units are available for laboratory studies. In all cases the equipment used should be carefully calibrated with respect to temperature, residence time and uniformity of air flow, and should be named in the written report.

11.7 Some disperse dyes may be partially decomposed during the extraction and are not suitable for this procedure.

11.8 Refer to AATCC Evaluation Procedure 6, Instrumental Color Measurement, paragraph 4.4, Color Strength Value Using Transmittance Measurement, and 4.5, Relative Strength, available from AATCC Technical Center, P.O. Box 12215, Research Triangle Park NC 27709; tel: 919/549-8141; fax: 919/549-8933; e-mail: orders@aatcc.org.

11.9 As a general guide for obtaining transmittance measurements, refer to A General Procedure for the Determination of Relative Dye Strength by Spectrophotometric Transmittance Measurements, *Textile Chemist and Colorist*, Vol., 4, No. 5, p43, May 1972.

Colorfastness to Solvent Spotting: Perchloroethylene

Developed in 1978 by AATCC Committee RR92; editorially revised and reaffirmed 1981, 1985, 1995; editorially revised 1986, 2001, 2002; reaffirmed 1990, 2000, 2005.

1. Purpose and Scope

1.1 This test method is designed to measure the degree of color migration that occurs when a fabric is spotted with a drycleaning solvent.

1.2 Perchloroethylene is used because it is a common drycleaning solvent.

2. Principle

2.1 A specimen, attached to a piece of white blotting paper, is placed specimen side up on a glass plate. Perchloroethylene is placed on the center of the specimen. The test is carried out at room temperature. The staining of the blotting paper is evaluated.

3. Terminology

3.1 **colorfastness**, n.—the resistance of a material to change in any of its color characteristics, to transfer of its colorant(s) to adjacent materials or both, as a result of the exposure of the material to any environment that might be encountered during the processing, testing, storage or use of the material.

3.2 **migration**, n.—the nonuniform movement and distribution of dyes, pigments, finishes or other materials from one part of a material to another.

3.3 **spotting**, n.—*in cleaning*, application of solvent or solution to a material prior to or after commercial scouring, laundering, or drycleaning to remove or enhance removal of soil or stains in a local area.

4. Safety Precautions

NOTE: These safety precautions are for information purposes only. The precautions are ancillary to the testing procedures and are not intended to be all inclusive. It is the user's responsibility to use safe and proper techniques in handling materials in this test method. Manufacturers MUST be consulted for specific details such as material safety data sheets and other manufacturer's recommendations. All OSHA standards and rules must also be consulted and followed.

4.1 Good laboratory practices should be followed. Wear safety glasses in all laboratory areas.

4.2 All chemicals should be handled with care.

4.3 Perchloroethylene is toxic by inhalation, by repeated contact with skin and by ingestion; it should be used only in a well vented atmosphere. Toxicology studies with laboratory animals have shown evidence of cancer in rats and mice exposed to perchloroethylene vapors at 100-400 ppm concentrations for prolonged times. Fabric saturated with this solvent should be dried in an adequately ventilated hood. Use chemical goggles or face shield, impervious gloves and an impervious apron when handling perchloroethylene.

4.4 An eyewash/safety shower should be located nearby and an organic vapor respirator should be readily available for emergency use.

4.5 Exposure to chemicals used in this procedure must be controlled at or below levels set by governmental authorities (e.g., Occupational Safety and Health Administration's [OSHA] permissible exposure limits [PEL] as found in 29 CFR 1910.1000 of January 1, 1989). In addition, the American Conference of Governmental Industrial Hygienists (ACGIH) Threshold Limit Values (TLVs) comprised of time weighted averages (TLV-TWA), short term exposure limits (TLV-STEL) and ceiling limits (TLV-C) are recommended as a general guide for air contaminant exposure which should be met (see 10.2).

5. Apparatus, Materials and Reagents

5.1 Pipette, graduated to deliver 1.5 mL.

5.2 Plate, glass.

5.3 AATCC Chromatic Transference Scale (see 10.1).

5.4 White AATCC Textile Blotting Paper (see 10.1).

5.5 Perchloroethylene; technical or commercial grades are acceptable.

6. Test Specimen

6.1 Piece of dyed fabric, 25 × 25 mm (1 × 1 in.).

7. Procedure

7.1 Attach test specimen to the center of a 150 × 150 mm (6 × 6 in.) piece of white

blotting paper. Make sure the sample is flat against the blotting paper. If necessary, staple the edges of the fabric down to keep the sample flat on the blotting paper.

7.2 Place blotting paper on the glass.

7.3 Deliver 1.5 mL of perchloroethylene (by pipette) on the center of the test specimen.

7.4 Let stand in air until dry; then evaluate the staining on the blotting paper.

8. Evaluation Method for Staining

8.1 Rate the degree of stain on the blotter using the Chromatic Transference Scale.

Grade 5—negligible or no color transfer.

Grade 4.5—color transfer equivalent to Step 4-5 on the Gray Scale for Staining or Row 4.5 on the 9-step AATCC Chromatic Transference Scale.

Grade 4—color transfer equivalent to Step 4 on the Gray Scale for Staining or Row 4 on the 9-step AATCC Chromatic Transference Scale.

Grade 3.5—color transfer equivalent to Step 3-4 on the Gray Scale for Staining or Row 3.5 on the 9-step AATCC Chromatic Transference Scale.

Grade 3—color transfer equivalent to Step 3 on the Gray Scale for Staining or Row 3 on the 9-step AATCC Chromatic Transference Scale.

Grade 2.5—color transfer equivalent to Step 2-3 on the Gray Scale for Staining or Row 2.5 on the 9-step AATCC Chromatic Transference Scale.

Grade 2—color transfer equivalent to Step 2 on the Gray Scale for Staining or Row 2 on the 9-step AATCC Chromatic Transference Scale.

Grade 1.5—color transfer equivalent to Step 1-2 on the Gray Scale for Staining or Row 1.5 on the 9-step AATCC Chromatic Transference Scale.

Grade 1—color transfer equivalent to Step 1 on the Gray Scale for Staining or Row 1 on the 9-step AATCC Chromatic Transference Scale.

8.2 Or compare degree of stain of sample before and after treatment (softening agent, resin, etc.).

9. Precision and Bias

9.1 *Precision*. Precision for this test method has not been established. Until a precision statement is generated for this method, use standard statistical techniques in making any comparisons of test

results for either *within-laboratory* or *between-laboratory* averages.

9.2 *Bias*. Colorfastness to solvent spotting (perchloroethylene) can be defined only in terms of a test method. There is no independent method for determining

the true value. As a means of estimating this property, the method has no known bias.

10. Notes

10.1 Available from AATCC, P.O. Box

12215, Research Triangle Park NC 27709; tel: 919/549-8141; fax: 919/549-8933; e-mail: orders@aatcc.org.

10.2 Available from Publications Office, ACGIH, Kemper Woods Center, 1330 Kemper Meadow Dr., Cincinnati OH 45240; tel: 513/742-2020.

Dimensional Changes on Drycleaning in Perchloroethylene: Machine Method

Developed in 1978 by AATCC Committee RA43; editorially revised and reaffirmed 1979, 1985, 1995; editorially revised 1986, 1991, 1993, 2004; reaffirmed 1990, 2000, 2005. Partly equivalent to ISO 3175.

Foreword

Drycleaning, a process for cleaning textiles in an organic solvent, dissolves oils and fats and disperses particulate dirt substantially without the swelling and creasing associated with washing or wet cleaning. Small quantities of water and surfactant may be incorporated in the solvent to obtain better soil and stain removal. Some moisture-sensitive articles are preferably drycleaned without the addition of water to the solvent but a surfactant can be used in order to assist soil removal and prevent graying. Different solvents can be used for drycleaning, of which perchloroethylene (tetrachloroethylene) is the most common in many countries. For this reason, the present method prescribes the use of perchloroethylene. Drycleaning is normally followed by an appropriate restorative finishing procedure. In most cases, this comprises some form of steam treatment and/or hot pressing. Dimensional change on drycleaning and steaming and/or pressing is progressive, and in some cases a single treatment may give little indication of the extent of dimensional change that may arise after repeated treatments. Generally, most of the potential dimensional change is released after 3-5 drycleaning and finishing treatments.

1. Purpose and Scope

1.1 This test method specifies a drycleaning procedure, using a commercial drycleaning machine, for the determination of dimensional change of fabrics and garments after drycleaning in perchloroethylene. It comprises processes for normal materials and sensitive materials (see 13.1).

1.2 Very sensitive materials, which can be cleaned only when special precautions are taken, are excluded from the scope of this method (see 13.1).

1.3 The test method is intended only for the assessment of dimensional changes undergone by a specimen subjected to a single drycleaning and finishing operation. When it is desired to deter-

mine the amount of progressive dimensional change, the method may be repeated a specified number of times, normally not exceeding five cycles.

2. Principle

2.1 Conditioned fabrics or garments are marked and measured, then subjected to a drycleaning procedure, followed by an appropriate finishing procedure. They are afterwards conditioned and measured. The dimensional change is expressed as a percentage of the original dimensions.

3. Terminology

3.1 **dimensional change**, n.—a generic term for variation in length or width of a garment or fabric specimen subjected to specified conditions.

3.2 **drycleaning**, n.—the cleaning of fabrics with organic solvents such as petroleum solvent, perchloroethylene or fluorocarbon.

NOTE: The process also includes adding detergent and moisture to the solvent, up to 75% RH, and hot tumble drying to 71°C (160°F).

4. Safety Precautions

NOTE: These safety precautions are for information purposes only. The precautions are ancillary to the testing procedures and are not intended to be all inclusive. It is the user's responsibility to use safe and proper techniques in handling materials in this test method. Manufacturers MUST be consulted for specific details such as material safety data sheets and other manufacturer's recommendations. All OSHA standards and rules must be consulted and followed.

4.1 Good laboratory practices should be followed. Wear safety glasses in all laboratory areas.

4.2 All chemicals should be handled with care.

4.3 Perchloroethylene is toxic by inhalation, by repeated contact with the skin and by ingestion; it should be used only in a well vented atmosphere. Toxicology studies with laboratory animals have shown evidence of cancer in rats and mice exposed to perchloroethylene vapors at 100-400 ppm concentrations for prolonged times. Fabric saturated with this solvent should be dried in an adequately ventilated hood. Use chemical goggles or face shield, impervious gloves

and an impervious apron when handling perchloroethylene.

4.4 An eyewash/safety shower should be located nearby and an organic vapor respirator should be readily available for emergency use.

4.5 The drycleaning apparatus should be ventilated to the outside atmosphere in accordance with the manufacturer's instructions.

4.6 Exposure to chemicals used in this procedure must be controlled at or below levels set by governmental authorities (e.g., Occupational Safety and Health Administration's [OSHA] permissible exposure limits [PEL] as found in 29 CFR 1910.1000 of January 1, 1989). In addition, the American Conference of Governmental Industrial Hygienists (ACGIH) Threshold Limit Values (TLVs) comprised of time weighted averages (TLV-TWA), short term exposure limits (TLV-STEL) and ceiling limits (TLV-C) are recommended as a general guide for air contaminant exposure which should be met (see 13.5).

5. Reagents

5.1 Perchloroethylene (commercial), CCl₂ = CCl₂, drycleaning grade.

5.2 Sorbitan mono-oleate (a typical chemical is Span 80).

6. Apparatus and Materials

6.1 Drycleaning machine. This shall consist of a commercial rotating cage type, totally enclosed machine for use with perchloroethylene. The diameter of the rotating cage shall be not less than 600 mm and not more than 1080 mm. Its depth shall be not less than 300 mm. It shall be fitted with three or four lifters. The speed shall be such as to give a g-factor (see 13.2) between 0.5 and 0.8 for cleaning and between 35 and 120 for extraction. The machine shall be equipped with a thermometer for the measurement of the solvent temperature. The machine shall have suitable facilities so that the emulsion can be introduced gradually into the solvent between the inner and outer cages below the level of the solvent. The machine may be of the single-unit washer/dryer type or a separate dryer may be used. Both types of dryers shall be equipped with temperature control of either the incoming or the outgoing air during the drying cycle. (Information on solvent recovery is given in 13.3.) The

dimensions of the rotating drum of the separate dryer shall comply with those given for the drycleaning machine.

6.2 Apparatus for applying the appropriate finishing treatment to the test specimen.

6.3 Means of producing the standard atmosphere for testing textiles.

6.4 Ballast consisting of clean textile pieces or garments. These shall be white or a light color and consist of about 80% wool and 20% cotton or rayon.

6.5 Pen and ink (indelible) or other suitable marking device.

6.6 Stable measuring scale of dimensions suitable for the article being tested, graduated in millimeters.

6.7 Flat table of dimensions such that the article being tested can be laid flat for measurement.

7. Test Specimens

7.1 Test garments as such.

7.2 Cut fabrics into test specimens preferably not smaller than 500 × 500 mm and stitched on all sides with polyester thread to prevent ravelling.

7.3 Carefully open elastic circular knits by cutting in the direction of the ribs without causing distortion. After marking and measuring according to Section 8, restore the circular state by sewing together the cut edges. After the test, the seam shall be cut again and distances between markings determined in the open state.

8. Preparation of Specimens

8.1 Condition the test specimens and dummy load from the dry side at 21 ± 1°C (70 ± 2°F) and 65 ± 2% RH by laying each test specimen separately on a flat, smooth, horizontal surface for at least 24 h.

8.2 When marking fabric specimens, lay out the specimen without tension on a flat, smooth surface, taking care to see that it is free from wrinkles and creases. Making three pairs of marks, each at least 250 mm apart in the length direction, and three similar pairs of marks in the width direction of the fabric. If the specimen is a garment, mark and measure different parts of the outer fabrics and linings separately.

9. Test Procedures

9.1 Procedure for normal materials.

9.1.1 The mass of the complete load shall be 50 ± 2 kg for each cubic meter of the volume of the inner cage. Ensure that the mass of the textile part of the test specimen(s) is not more than 10% of the total load, the remainder consisting of the ballast unless the mass of the test piece of garment as such exceeds 10% of the total

load.

When loaded into the machine, the specimen(s) and the ballast shall be in equilibrium with the standard atmosphere for testing textiles. Equilibrium is deemed to be attained after exposure for 24 h to this atmosphere.

9.1.2 Place the conditioned load in the machine and introduce perchloroethylene containing 1 g/L of sorbitan mono-oleate so that the liquor ratio, calculated on the volume of solvent in the outer and inner cages, is 0.65 ± 0.5 L for each kg of load (this corresponds to a solvent level of about 30% of the inner cage diameter). Maintain the solvent at 30 ± 3°C (86 ± 5°F) throughout the cleaning operation.

9.1.3 Prepare an emulsion by mixing 1 part (by volume) of the sorbitan mono-oleate with 3 parts of perchloroethylene and then adding 2 parts of water (with stirring). Start the machine with the filter circuit shut off and slowly (over a period of not less than 2 min and not more than 12 min) add an amount of emulsion corresponding to 2% of water calculated on the mass of the load, to the machine between the inner and outer cages below the level of the solvent.

9.1.4 Keep the machine running for 15 min after switching it on. The filter circuit test is not used during any part of this test except the initial solvent fill in 9.1.2.

9.1.5 Drain the solvent and centrifugally extract the solvent from the load for 2 min (at least 1 min being at full extraction speed).

9.1.6 Introduce pure dry solvent at the same liquor ratio (see 9.1.2) and rinse for 5 min. Drain and extract again for 3 min (at least 2 min being at full extraction speed).

9.1.7 Dry the load in the machine or in a separate drying tumbler, by tumbling in circulating warm air for an appropriate time, preferably using an automatic solvent-dryness control. Either the outlet air temperature shall not exceed 60°C (140°F), or the inlet temperature shall not exceed 80°C (176°F) (see 13.4). After drying, blow air at ambient temperature through the rotating load for 3-5 min.

9.1.8 Remove the specimens from machine immediately. Place garments individually on hangers and place fabric specimens on a flat surface for not less than 30 min before finishing.

NOTE: If additional information on stability to drycleaning only is required, condition and remeasure the specimen at this stage before completing the procedure. Note details of this procedure in the test report.

9.1.9 Carry out a finishing treatment by the method appropriate for the type of garment or fabric under test. In most cases, this will involve pressing on a garment (steam) press supplied with steam at a pressure of 370-490 kPa² (3.8-5 kg/cm²)

(oven-pressure) or steaming on a steam/air garment former for 5-20 s followed by drying with warm air for 5-20 s.

9.1.10 Condition the specimen according to 8.1 and measure, according to 8.2, the distances previously marked and measured.

9.2 Procedure for sensitive materials.

9.2.1 Proceed as in 9.1.1 but use a total load of mass 33 ± 2 kg for each cubic meter of the volume of the inner cage.

9.2.2 Proceed as in 9.1.2 but increase the amount of solvent to 10 ± 1 L/kg of load (this gives about the same solvent level as in 9.1.2).

9.2.3 Proceed as in 9.1.3 but operating at solvent relative humidity of 63 ± 2%. This means that no water emulsion addition is necessary.

9.2.4 Proceed as in 9.1.4 but reduce the running time to 10 min.

9.2.5 Proceed as in 9.1.5-9.1.10 but reduce the period of extraction at full extraction speed to 1 min.

9.2.6 Lay the specimen out according to 8.2 and measure the distance between marks to the nearest millimeter. Measure overall dimensions of garments to within ± 2 mm. Make all measurements in the standard atmosphere for conditioning and testing textiles as given in 8.1.

10. Calculation and Expression of Results

10.1 Calculate the dimensional change in the length and width directions of each fabric specimen or in the principal dimensions of a garment. Express as average percentage dimensional change, rounded to the nearest 0.2%, using a minus sign to indicate shrinkage and a plus sign to indicate an increase in dimensions.

11. Test Report

11.1 State that the tests were made in accordance with this method and give the following information:

(a) Details of any optional or additional requirements that have been met.

(b) Whether the procedure in 9.1 or 9.2 was used.

(c) The results obtained according to Section 10.

(d) The percentage by mass of specimen(s) in the load, and the type of material comprising the ballast.

(e) The maximum inlet or outlet air temperature during drying.

(f) Details of the finishing treatment used.

(g) The number of treatments given.

(h) Details of the dimensions of the garment or fabric specimen as required by the method.

12. Precision and Bias

12.1 *Precision.* Precision for this test method has not been established. Until a precision statement is generated, use standard statistical techniques in making any comparisons of test results for either *within-laboratory* or *between-laboratory* averages.

12.2 *Bias.* Dimensional change on drycleaning in perchloroethylene by machine can be defined only in terms of a test method. There is no independent method for determining the true value. As a means of estimating this property, the method has no known bias.

13. Notes

13.1 Examples of sensitive materials are woolen knitwear; fur fabrics; crepes; open set, loose spun wool fabrics; loom finished fabrics; boucles; Bedford cords; cavalry twills; raschel fabrics; chenille; cloque fabrics; pure silk fabrics; etc.

13.2 The *g* factor is calculated according to the following formula:

$$g = \frac{5.6n^2d}{10,000,000}$$

where:

n = the number of revolutions per min

d = the diameter, in mm, of the rotating cage

13.3 When using commercial drycleaning equipment, official regulations and normal safety precautions should be observed.

13.4 Textiles made of, or containing, heat sensitive fibers—for example, modacrylic fibers—shall be dried at an outlet air temperature not exceeding 40°C (104°F) [inlet air temperature up to 60°C (140°F)]. Very heat sensitive textiles, such as articles containing polyvinyl chloride fibers, shall be removed from the machine after extraction and dried at room temperature.

13.5 Available from Publications Office, ACGIH, Kemper Woods Center, 1330 Kemper Meadow Dr., Cincinnati OH 45240; tel: 513/742-2020.

Transfer of Acid and Premetalized Acid Dyes on Nylon

Developed in 1979 by AATCC Committee RA87; editorially revised and reaffirmed 1984, 1989 (title change), 1994, 1999; editorially revised 1985, 1987, 1997, 2004.

1. Purpose and Scope

1.1 This test method evaluates the transfer of an acid (anionic) or premetalized dye from a dyed to an undyed nylon substrate under mock dyeing conditions. A general method of dyeing acid dyes on nylon is included for uniformity of dyeing procedure.

2. Principle

2.1 A test specimen of nylon fabric is dyed to 1/1 standard depth with the dye to be evaluated. Part of the dyed fabric together with an equal weight of undyed fabric is subjected to transfer in a mock dye bath.

2.2 Transfer is made at pH 4.5, 6.0 and 7.5, and at a temperature of 95°C.

3. Terminology

3.1 **acid dye**, n.—an anionic dye having substantivity for fibers which contain cationic groups usually in acidic or neutral aqueous dye baths.

3.2 **premetallized acid dye**, n.—an acid dye manufactured by reacting an equivalent of a suitable metal ion with one equivalent of a dye (1:1 premetalized acid dye), or with two equivalents of the same or different dyes (1:2 premetallized acid dyes), capable of chelating the metal.

3.3 **transfer**, n.—in *textile processing, testing, storage and use*, movement of a chemical, dye or pigment between fibers within a substrate or between substrates (see also *migration, leveling*).

4. Safety Precautions

NOTE: These safety precautions are for information purposes only. The precautions are ancillary to the testing procedures and are not intended to be all inclusive. It is the user's responsibility to use safe and proper techniques in handling materials in this test method. Manufacturers MUST be consulted for specific details such as material safety data sheets and other manufacturer's recommendations. All OSHA standards and rules must also be consulted and followed.

4.1 Good laboratory practices should be followed. Wear safety glasses in all

laboratory areas and a single-use dust respirator while handling powder dyes.

4.2 All chemicals should be handled with care. Use chemical goggles or face shield, impervious gloves and an impervious apron when dispensing concentrated acids and sodium hydroxide.

4.3 An eyewash/safety shower should be located nearby and an organic vapor respirator with full facepiece should be readily available for emergency use.

4.4 Exposure to chemicals used in this procedure must be controlled at or below levels set by governmental authorities (e.g., Occupational Safety and Health Administration's [OSHA] permissible exposure limits [PEL] as found in 29 CFR 1910.1000 of January 1, 1989). In addition, the American Conference of Governmental Industrial Hygienists (ACGIH) Threshold Limit Values (TLVs) comprised of time weighted averages (TLV-TWA), short term exposure limits (TLV-STEL) and ceiling limits (TLV-C) are recommended as a general guide for air contaminant exposure which should be met (see 9.1).

5. Apparatus and Materials

- 5.1 Dyed nylon.
- 5.2 Undyed nylon (from same piece as dyed sample).
- 5.3 Nonionic surfactant.
- 5.4 Sodium carbonate.
- 5.5 Phosphoric acid (usually 85%).
- 5.6 Acetic acid, glacial.
- 5.7 Boric acid (H_3BO_3).
- 5.8 Sodium hydroxide.
- 5.9 Acetic acid, 56%.
- 5.10 EDTA (ethylenediaminetetraacetic acid, tetrasodium salt, 100% powder).

6. Procedure

- 6.1 Fabric Preparation.
 - 6.1.1 Scour undyed fabric in a bath containing 1.5 g/L nonionic surfactant (5.3) and 1.5 g/L sodium carbonate for 30 min at 50-60°C.
 - 6.1.2 Rinse thoroughly in water.
 - 6.1.3 Neutralize with acetic acid, 1 mL/L 56% acetic acid.
 - 6.1.4 Final rinse in water.
 - 6.1.5 Air dry.
- 6.2 Dyeing Procedure.
 - 6.2.1 Set 30:1 bath at 38°C (100°F); X.XX% dye; 0.25% EDTA sequestrant (omit for neutral premetallized dyes; and 2.00% acetic acid (56%).
 - 6.2.2 Enter nylon substrate (cloth, yarn, stock) at 38-48°C.
 - 6.2.3 Raise temperature to boil at

1.5C/min.

- 6.2.4 Dye at or near boil for 45 min.
- 6.2.5 If necessary, add an additional 1.0% acetic acid (56%) to exhaust dye.
- 6.2.6 Run an additional 15 min.
- 6.2.7 Rinse in hot 80-90°C water, then in 38C water.
- 6.2.8 Air dry.
- 6.3 Transfer Bath Preparation (see Appendix I).

6.3.1 Prepare 200 mL mock dye baths (one for each dye to be tested) for pH 4.5, 6.0 and 7.5 as described in Appendix I.

6.3.2 Add one 5 g piece of dyed fabric and one 5 g piece of undyed fabric to each mock dye bath; B/F = 20/1.

6.3.3 It has been shown that the degree of agitation is a contributing factor affecting the rate of diffusion of dyes into and out of a substrate. Agitation should be the same for all comparative experiments.

6.3.4 Raise temperature at 2°C/min to 95°C and run with agitation for 50 min. Save the bath (see 6.3.6).

6.3.5 Remove both pieces of fabric. Rinse with water and air dry.

6.3.6 Measure pHs of part of the transfer baths at room temperature and record in the table attached.

6.3.7 Add a piece of undyed nylon to the transfer bath and exhaust. Adjust pH to 4.5 to accomplish. Record pH in table.

7. Evaluation and Reporting

- 7.1 Comparison of Dyes at pH 4.5.
 - 7.1.1 For best observations, samples should be butted together on white board as shown in Fig. 1.
 - 7.1.2 Mount pH 6.0 and 7.5 samples similarly.
- 7.2 Comparison of Dye A at pH 4.5, 6.0 and 7.5.
 - 7.2.1 Mount samples on white board as shown in Fig. 2.
 - 7.2.2 Mount Dye B and Dye C samples similarly.
- 7.3 Compare and record differences in depth and shade of the "to" samples to the "from" samples. The AATCC Gray Scale for Color Change is useful in judging the degree of difference.
- 7.4 Note the amount of stain on the "Exhaust" sample. In this evaluation, the AATCC Gray Scale for Staining is helpful.
- 7.5 Record type of nylon and manufacturer on all test boards.

8. Precision and Bias

8.1 *Precision*. Precision for this test method has not been established. Until a precision statement is generated for this

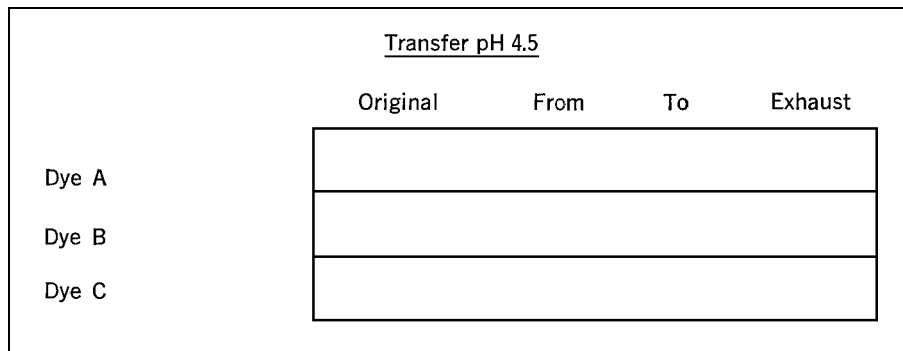

Fig. 1

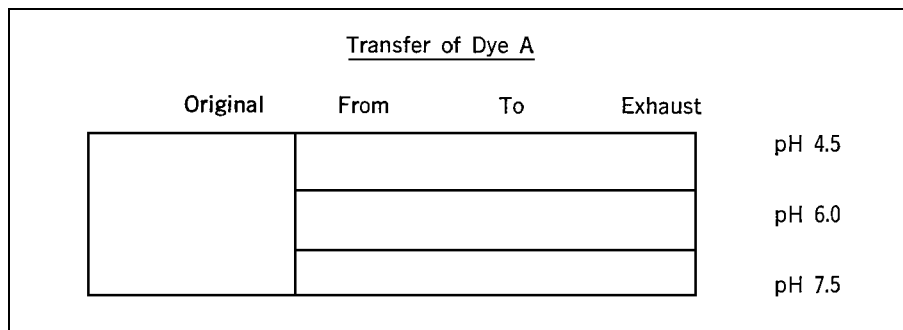

Fig. 2

method, use standard statistical techniques in making any comparisons of test results for either *within-laboratory* or *between-laboratory* averages.

8.2 *Bias*. The transfer of acid and pre-metalized acid dyes on nylon can be defined only in terms of a test method. There is no independent method for determining the true value. As a means of estimating this property, the method has no known bias.

9. Note

9.1 Available from Publications Office, ACGIH, Kemper Woods Center, 1330

Kemper Meadow Dr., Cincinnati OH 45240; tel: 513/742-2020.

**Appendix I
Preparation of Buffered Mock Dyebaths**

Prepare two solutions as follows using distilled water (tap water can be used if distilled water is not available):

SOLUTION A—5 g phosphoric acid (100%); 2.4 g acetic acid (100%); and 1.76 g boric acid (HBO₂ 100%). Make to 1L of solution.

SOLUTION B—8 g sodium hydroxide. Make to 1L of solution.

Prepare mock dyebaths as shown in

Table I using a pH meter. The amount of Solution B required to obtain the desired pH may vary slightly. Add Solution B to Solution A, checking end point with pH meter. Dilute to 600 mL with deionized water. This is sufficient for three mock dyebaths at each pH value.

Table I—Preparation of Mock Dyebaths

	Solution A	Solution B	Solution C
pH 4.5	100 mL	ca. 35 mL	600 mL
pH 6.0	100 mL	ca. 50 mL	600 mL
pH 7.5	100 mL	ca. 10 mL	600 mL

Chelating Agents: Disperse Dye Shade Change Caused by Metals; Control of

Developed in 1983 by AATCC Committee RA90; editorially revised 1985, 1988 (with title change), 2004; editorially revised and reaffirmed 1986, 1987, 1992, 2002.

1. Purpose and Scope

1.1 This test method provides a laboratory procedure for:

1.1.1 Determining the effectiveness of chelating agents in disperse dyebaths for inactivating heavy metals which can cause shade change.

1.1.2 Evaluating the sensitivity of disperse dyes to metal induced shade change during dyeing.

2. Principle

2.1 The effectiveness of chelating agents in sequestering metals in a dye-bath, thereby preventing metal-induced shade change, is determined by the protocol in Fig. 1.

2.2 Metal sensitivity of disperse dyes is determined by comparing control dyes and test dyes by the protocol shown in Fig. 2.

3. Terminology

3.1 **chelating agent**, n.—in *textile chemistry*, a chemical capable of inactivating metal ions by formation of a water soluble complex. SYN: *sequestering agent*.

3.2 **metal sensitivity**, n.—the propensity of a dye to produce an abnormal color on a textile material when in the presence of certain metal ions.

3.3 **shade change**, n.—a change from the normal or expected color of a textile material.

4. Safety Precautions

NOTE: These safety precautions are for information purposes only. The precautions are ancillary to the testing procedures and are not intended to be all inclusive. It is the user's responsibility to use safe and proper techniques in handling materials in this test method. Manufacturers MUST be consulted for specific details such as material safety data sheets and other manufacturer's recommendations. All OSHA standards and rules must also be consulted and followed.

4.1 Good laboratory practices should be followed. Wear safety glasses in laboratory areas.

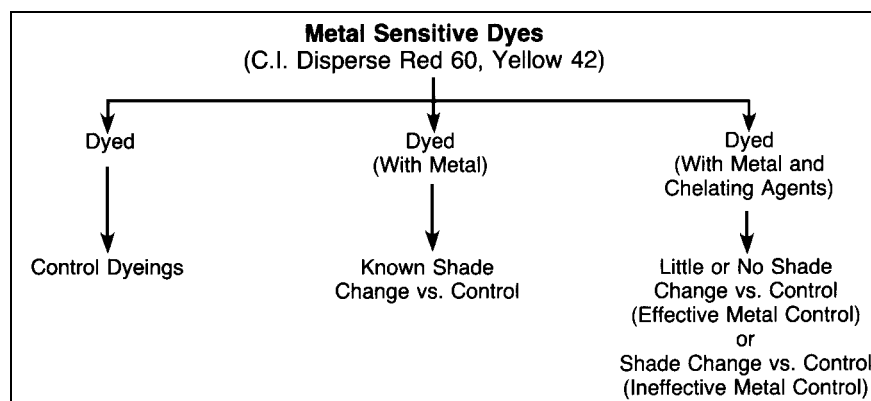

Fig. 1

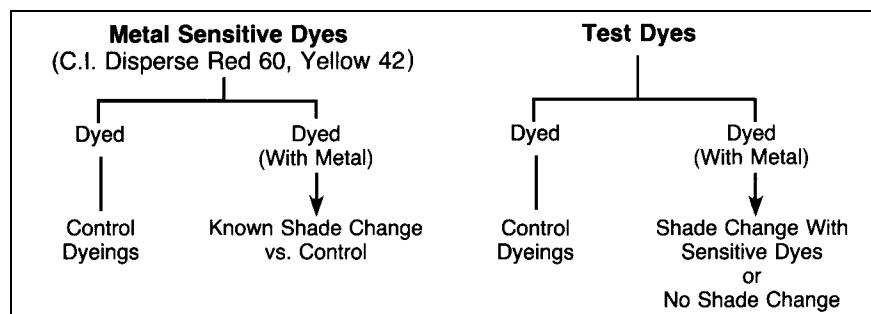

Fig. 2

4.2 Pressurized dyeing equipment is required for some dyeing. Trained personnel should exercise care and follow the equipment manufacturer's instructions for use and safety precautions.

4.3 All chemicals should be handled with care.

4.4 In preparing, dispensing and handling acetic acid and phosphoric acid, use chemical goggles or face shield, impervious gloves and an impervious apron. Concentrated acids should be handled only in an adequately ventilated laboratory hood. CAUTION: Always add acid to water.

4.5 Carriers vary in toxicity depending on type. Read vendors technical data, MSDS and/or product label for contents and/or OSHA hazard classification.

4.6 An eyewash/safety shower should be located nearby and a high efficiency particulate respirator with a full facepiece should be readily available for emergency use.

4.7 Exposure to chemicals used in this procedure must be controlled at or below

levels set by governmental authorities [e.g., Occupational Safety and Health Administration's (OSHA) permissible exposure limits (PEL) as found in 29 CFR 1910.1000 of January 1, 1989]. In addition, the American Conference of Governmental Industrial Hygienists (ACGIH) Threshold Limit Values (TLVs) comprised of time weighted averages (TLV-TWA), short term exposure limits (TLV-STEL) and ceiling limits (TLV-C) are recommended as a general guide for air contaminant exposure which should be met (see 12.19).

5. Uses and Limitations

5.1 Accurate results and expected shade changes depend on the particular metal dye and carrier used as well as close control of all dyeing parameters.

5.2 Extraneous metal contamination can give misleading results. Use clean fabrics, distilled water, and rinse the dye containers with a 10% phosphoric acid solution followed by a distilled water rinse.

5.3 To avoid erroneous conclusions, test conditions must be established with dyes of known metal sensitivity to verify that the expected shade change can be obtained. Particular samples of control dyes or carriers, or certain dyeing conditions, may not produce the expected shade change.

5.4 This test method is not intended for use with disperse dyes in combination with other dye classes which may contain metal complexes that are potentially damaged by chelating agents.

6. Apparatus and Materials

6.1 Test fabric. Clean 100% polyester fabric (filament or staple), desized (as needed) and prescoured (see 12.1).

6.2 Control dyes (C. I. Disperse Red 60 and C. I. Disperse Yellow 42) (see 12.2 and 12.3).

6.3 Test dyes.

6.4 ACS Reagent CuSO_4 (cupric sulfate) MW 159.606.

6.5 ACS Reagent $\text{Fe}(\text{NH}_4)_2(\text{SO}_4)_2 \cdot 6\text{H}_2\text{O}$ (ferrous ammonium sulfate) MW 392.158.

6.6 Carrier (if used).

6.7 Chelating agent.

6.8 Distilled water.

6.9 ACS Reagent CH_3COOH (acetic acid) 99.7%.

6.10 ACS Reagent H_3PO_4 (phosphoric acid) 85%.

6.11 Dyeing apparatus capable of providing good agitation and uniform temperature control.

6.12 Gray Scale for Color Change (see 12.20).

7. Test Specimens

7.1 For each test, cut an appropriate number of equal weight specimens of polyester fabric. A convenient weight for each specimen is 10 g.

8. Procedure

8.1 Weigh accurately 2.0 g of the test and control dyes.

8.2 Measure 100 mL of distilled water and heat to 49–60°C (120–140°F). Add a small quantity of this water to the dye from 8.1. Paste well with a stirring rod until the dye is dispersed. Add several aliquots of this water with stirring. Dilute to 1000 mL with distilled water to give a 2.0 g/L dye dispersion.

8.3 Weigh accurately 2.51 g of cupric sulfate and 7.02 g of ferrous ammonium sulfate.

8.4 Prepare a solution of each of the metal salts from 8.3 in 1000 mL of distilled water. This will result in a solution of 1.0 g/L metal ions (see 12.4 and 12.5).

8.5 Weigh accurately the carrier, if used (see 12.6).

8.6 Prepare a 50.0 g/L carrier-solution using distilled water.

8.7 Weigh accurately the chelating agent (see 12.7).

8.8 Prepare a 10.0 g/L chelating agent solution using distilled water.

8.9 Prior to dyeing, rinse all dyeing containers with a 10% solution of phosphoric acid followed by distilled water rinse.

8.10 Prepare dyebaths according to Table I. (If test dyes are to be evaluated, use test dye amounts to give a depth of shade comparable to that of C. I. Disperse Yellow 42 dyes.)

8.11 Pre-wet specimens in distilled water. Squeeze to remove excess water. Add to the dyebath with stirring.

8.12 Use a pH meter to adjust dyebath including specimen to pH 5.0 with acetic acid (see 12.8 and 12.9).

8.13 Load pressure dyeing containers into Atlas Launder-Ometer (or comparable equipment). Load atmospheric boil dyeings into suitable dyeing apparatus.

8.14 Raise to dyeing temperature at 2.2°C/min (4°F). Run atmospheric dyeings at the boil for 60 min and pressure

dyeings for 30 min at 130°C (265°F).

8.15 Cool and remove dye containers.

8.16 Afterscour specimens with:

1.0% owf nonionic detergent

2.0% owf sodium carbonate

scour 10 min at 71°C (160°F)

Rinse

Neutralize to pH 7 ± 0.5 with acetic acid

Rinse

(Distilled water optional for after scour).

8.17 Dry.

9. Evaluation

9.1 Mount the specimens side by side, face up with the warps in the same direction.

9.2 Visually determine the shade change for the test dyeings by comparing to control dyeings utilizing a Gray Scale for Color Change (AATCC Evaluation Procedures 1 and 7).

10. Report

10.1 Report the Gray Scale ratings for color change.

10.2 Report the instrumental evaluation data.

11. Precision and Bias

11.1 *Precision.* Precision of this method is being established. Until a precision statement is generated for this method, use standard statistical techniques in making any comparisons of test results for either *within-laboratory* or *between-laboratory* averages.

11.2 *Bias.* The true value of disperse dye shade change cause by metals can only be defined in terms of a test method. Within this limitation, this method has no known bias.

Table I—Composition of Dyebath and Conditions of Use for Evaluating Disperse Dye Shade Change and Chelating Agents (See 12.10)

Parameters	Dye at Boil, Metals Tested		Dye Under Pressure (130°C [265°F]) Metals Tested		
	Cupric C.I.	Ferrous C.I.	Cupric C.I.	Cupric C.I.	Ferrous C.I.
	Disperse Red 60	Disperse Red 60	Disperse Red 60	Disperse Yellow 42	Disperse Red 60
Fabric Weight	10 g	10 g	10 g	10 g	10 g
Water Amount (see 12.11)	251 mL	176 mL	267 mL	267 mL	184 mL
Chelating Agent Amount	0.5% (5 mL)	0.5% (5 mL)	0.5% (5 mL)	0.5% (5 mL)	0.5% (5 mL)
Metal Amount	10 ppm (3 mL)	10 ppm (3 mL)	10 ppm (3 mL)	10 ppm (3 mL)	10 ppm (3 mL)
Carrier Amount (see 12.12 and 12.13)	8.0% (16 mL)	8.0% (16 mL)	No carrier	No carrier	4.0% (8 mL)
Dye Amount (see 12.14)	0.5% (25 mL)	2.0% (100 mL)	0.5% (25 mL)	0.5% (25 mL)	2.0% (100 mL)
Adjust pH with Acetic Acid to	5.0	5.0	5.0	5.0	5.0
Liquor-To-Goods Ratio (see 12.16)	30/1	30/1	30/1	30/1	30/1
Dyeing Temperature	Boil	Boil	130°C (265°F)	130°C (265°F)	130°C (265°F)
Dyeing Time	60 min	60 min	30 min	30 min	30 min

In addition to the formulations listed above, needed dyeings include: (a) Control dyeing: eliminate trace metal and chelating agent and increase water by 8 mL. (b) Dyeing with metal: eliminate chelating agent and increase water by 5 mL. Solution Concentrations: Dye, 2 g/L; Cupric or Ferrous ions, 1 g/L; Chelating agent, 10 g/L; Carrier, 50 g/L.

12. Notes

12.1 Fabric from mill production is suggested. Clean 100% polyester fabric for use as a control is available from AATCC, P.O. Box 12215, Research Triangle Park NC 27709; tel: 919/549-8141; fax: 919/549-8933; e-mail: orders@aatcc.org.

12.2 C.I. Disperse Red 60 and Disperse Yellow 42 dyes which exhibit known shade changes are available from AATCC, P.O. Box 12215, Research Triangle Park NC 27709; tel: 919/549-8141; fax: 919/549-8933; e-mail: orders@aatcc.org.

12.3 C.I. Disperse Red 60 or Disperse Yellow 42 dyes from different manufacturers may yield different results. Control dyeings are necessary to verify that shade change is possible under the test dyeing conditions. If shade change does not occur, repeat the test. Contact AATCC Technical Center for assistance if needed.

12.4 The ferrous salt solution is unstable and will form a precipitate on standing. Make up fresh daily.

12.5 Check the metal solutions before use. Discard if there is any flocculation or sedimentation.

12.6 With C.I. Disperse Red 60 and ferrous

ions, some carriers may cause shade change due to dye dispersion breakage. An uneven, bluish-red color which crocks is characteristic of this broken dispersion.

12.7 Introduction of a sufficient amount of an EDTA chelating agent to dye baths of C.I. Disperse Red 60 or Disperse Yellow 42 with cupric or ferrous ions present has been found to give essentially the expected dyed shade without metals.

12.8 Use ACS reagent grade chemicals to minimize metal contamination.

12.9 Calibrate the pH meter before use with standard pH 4.0 and pH 7.0 buffer solutions.

12.10 No appreciable shade change was found to occur with C.I. Disperse Red 60 or Disperse Yellow 42 at dyeing conditions other than those listed in Table I. For example, C.I. Disperse Yellow 42 did not show sufficient shade change with iron or copper at the boil, or with iron under pressure to give a positive test.

12.11 Use distilled water for accurate results. Tap water may be substituted in the after scour.

12.12 Tests were developed without carrier where possible. If essential to the test, carrier is indicated.

12.13 Use an appropriate carrier and

amount with adjusted amounts of distilled water as necessary.

12.14 Dye concentrations to yield maximum shade change were selected.

12.15 Use amounts of test dyes to give a comparable depth of shade to the amounts of C.I. Disperse Red 60 or Disperse Yellow 42 suggested in Table I.

12.16 A 30:1 liquor-to-goods ratio was selected for laboratory convenience. Prior evaluations indicated no appreciable difference between 10:1, 20:1 and 30:1 liquor-to-goods ratios.

12.17 All percentages are based on the weight of the fiber.

12.18 EDTA was used in the establishment of this test method. Other commercially available chelating agents may give effective results. Their effectiveness can be evaluated with this test method.

12.19 Available from: Publications Office, ACGIH, Kemper Woods Center, 1330 Kemper Meadow Dr., Cincinnati OH 45240; tel: 513/742-2020.

12.20 Available from AATCC, P.O. Box 12215, Research Triangle Park NC 27709; tel: 919/549-8141; fax: 919/549-8933; e-mail: orders@aatcc.org.

Colorfastness to Water: Chlorinated Pool

Developed in 1984 by Committee RA23. Supersedes AATCC Test Method 105-1975; editorially revised 1985, 1995; editorially revised and reaffirmed 1986, 1997; reaffirmed 1991, 2002. Related to ISO 105-E03.

1. Purpose and Scope

1.1 This test method is intended for evaluating the resistance to chlorinated pool water of dyed, printed or otherwise colored textile yarns and fabrics of all kinds.

2. Principle

2.1 Yarn or fabric specimens are agitated at a fixed rate in diluted chlorine solution under specified conditions of temperature, time, pH and hardness. The dried specimens are evaluated for change in color.

3. Terminology

3.1 **colorfastness**, n.—the resistance of a material to change in any of its color characteristics, to transfer of its colorant(s) to adjacent materials or both, as a result of the exposure of the material to any environment that might be encountered during the processing, testing, storage or use of the material.

3.2 **pool water**, n.—water in a large container to which various chemicals are added to maintain purity and clarity, normally used for swimming.

4. Precautions

NOTE: These safety precautions are for information purposes only. The precautions are ancillary to the testing procedures and are not intended to be all inclusive. It is the user's responsibility to use safe and proper techniques in handling materials in this test method. Manufacturers MUST be consulted for specific details such as material safety data sheets and other manufacturer's recommendations. All OSHA standards and rules must also be consulted and followed.

4.1 Good laboratory practices should be followed. Wear safety glasses in all laboratory areas.

4.2 All chemicals should be handled with care.

4.3 When using 6*N* sulfuric acid and acetic acid, use chemical goggles or face shield, impervious gloves and an impervious apron. Concentrated acids should

be handled only in an adequately ventilated laboratory hood. CAUTION: Always add acid to water.

4.4 An eyewash/safety shower should be located nearby and a high efficiency particulate respirator with a full face-piece should be readily available for emergency use.

4.5 Manufacturer's safety recommendations should be followed when operating laboratory testing equipment.

4.6 Observe padder safety. Ensure adequate guard at the nip point. Normal safeguards on pad should not be removed. A foot-operated kickoff is recommended.

4.7 Exposure to chemicals used in this procedure must be controlled at or below levels set by governmental authorities (e.g., Occupational Safety and Health Administration's [OSHA] permissible exposure limits [PEL] as found in 29 CFR 1910.1000 of January 1, 1989). In addition, the American Conference of Governmental Industrial Hygienists (ACGIH) Threshold Limit Values (TLVs) comprised of time weighted averages (TLV-TWA), short term exposure limits (TLV-STEL) and ceiling limits (TLV-C) are recommended as a general guide for air contaminant exposure which should be met (see 11.1).

5. Apparatus and Materials

5.1 SGS U.S. Testing Co. Inc. dry-cleaning and washing machine #6523 (see 11.2).

5.2 Wringer (see 11.3).

5.3 Gray Scale for Color Change (see 11.7).

5.4 Household sodium hypochlorite solution (NaOCl), approximately 5% available chlorine (see 11.4).

5.5 Calcium chloride, anhydrous (CaCl₂) (see 11.5).

5.6 Magnesium chloride, hexahydrate (MgCl₂ · 6H₂O) (see 11.6).

5.7 Test Control Fabric 162 (see 11.7).

5.8 Sulfuric acid (H₂SO₄), 6*N*.

5.9 Potassium iodide, KI, 12%.

5.10 Starch solution, 1%.

5.11 Sodium thiosulfate (Na₂S₂O₃), 0.01*N*, (see 11.8).

5.12 Distilled or deionized water.

5.13 Sodium carbonate (Na₂CO₃).

5.14 Acetic acid (CH₃COOH).

6. Preparation of Reagents

6.1 Deionized or distilled water to which 5 ppm chlorine and 100 ppm salts

(hardness concentrate) are added; adjusted to 21°C (70°F) and pH 7.0 with sodium carbonate or acetic acid.

7. Test Specimens

7.1 Colored specimens, approximately 6 × 6 cm. Total weight of test specimens should be 5.0 ± 0.25 g. If specimens to be tested do not weigh 5.0 g, add multiple specimens to make 5.0 g. Include the Test Control Fabric in the 5.0 g weight. Different colored specimens can be mixed when making up the 5.0 g load.

8. Procedure

8.1 Purge the drycleaning cylinder. Add approximately 5000 mL deionized water and 0.5 mL Clorox or equivalent (see 11.4). Close cylinder and run for 10 min (purging is necessary only if cylinder has been used for testing other than chlorinated pool water, or has not been used for a period of two weeks). Discard this solution.

8.2 Prepare hardness concentrate.

8.2.1 Weigh out 8.24 g calcium chloride, anhydrous.

8.2.2 Weigh out 5.07 g magnesium chloride hexahydrate, MgCl₂ · 6H₂O.

8.2.3 Add 800 mL deionized or distilled water to a 1 L volumetric flask; add calcium chloride and magnesium chloride while stirring to dissolve. Bring volume up to 1 L with water. This is a "hardness concentrate" which can be retained and used for 30 days.

8.3 Dilute 51 mL hardness concentrate to 5100 mL with deionized or distilled water. Add 0.5 mL Clorox or equivalent which is no more than 60 days old. Determine actual ppm Cl by titration and adjust to 5 ppm (see 11.8).

8.3.1 0.01*N* Sodium thiosulfate can be purchased in this form or can be diluted 10 to 1 volumetrically from 0.1*N* solution.

8.4 Adjust solution to pH 7.0 with sodium carbonate or acetic acid as necessary.

8.5 Place the 5000 mL solution (from 8.3) in the cylinder of the testing machine. Adjust temperature to 21°C (70°F).

8.6 Place colored test specimens including test control fabric in cylinder, close and tumble for 60 min.

8.7 Remove the test specimens and pass through wringer to remove excess solution. Rinse thoroughly with deionized or distilled water. Wring again and allow to dry on absorbent, bleached paper toweling at room temperature.

9. Evaluation Method for Color Change

9.1 Classify the change in color of the Test Control Fabric 162 with the Gray Scale for Color Change. If the classification is not equivalent to a 2-3 or 3, the test is considered to be invalid. If classification is equivalent to a 2-3 or 3, proceed with 9.2.

9.2 Rate the change in color of test specimens with the Gray Scale for Color Change (see 11.7 and 11.9).

Grade 5—negligible or no change as shown in Gray Scale Step 5.

Grade 4.5—change in color equivalent to Gray Scale Step 4-5.

Grade 4—change in color equivalent to Gray Scale Step 4.

Grade 3.5—change in color equivalent to Gray Scale Step 3-4.

Grade 3—change in color equivalent to Gray Scale Step 3.

Grade 2.5—change in color equivalent to Gray Scale Step 2-3.

Grade 2—change in color equivalent to Gray Scale Step 2.

Grade 1.5—change in color equivalent to Gray Scale Step 1-2.

Grade 1—change in color equivalent to Gray Scale Step 1.

10. Precision and Bias

10.1 *Interlaboratory Test Data.* Interlaboratory tests were conducted in 1982 and 1983 in which six laboratories each made five replications on six fabrics. Color change was evaluated instrumentally and Gray Scale ratings calculated from the instrumental readings. The components of variance expressed as the

Variance Ratio (F) shows a within laboratory ratio of 1.43, with no laboratory having a statistically significant variation between tests. All tests included a standard test control fabric, and only tests in which the test control fabric rated 2-3 or 3 were considered to be valid. The average standard deviation was 0.18 Gray Scale unit. Between laboratory correlation showed greater variance, with two of the five colors showing statistically significant difference between laboratories. Therefore, before a meaningful statement can be made about two specific laboratories, the amount of statistical bias, if any, between them must be established (see 11.9).

10.2 *Precision.* Based on the observation described in 10.1, a test is considered to be valid if test control fabric is rated at 2-3 or 3 on the AATCC Gray Scale for Color Change.

10.3 *Bias.* The true value of Colorfastness to Chlorinated Swimming Pool Water can only be defined in terms of a test method. Within this limitation, this test method has no known bias.

11. Notes

11.1 Available from Publications Office, ACGIH, Kemper Woods Center, 1330 Kemper Meadow Dr., Cincinnati OH 45240; tel: 513/742-2020.

11.2 Drycleaning and washing machine #6523; maximum working capacity 7650 mL, SGS U.S. Testing Co. Inc., Instrument Marketing Div., 291 Fairfield Ave., Fairfield NJ 07004; tel: 973/575-5252 or 800/777-8378.

11.3 The Atlas Motorized Laboratory Wringer is suitable and may be obtained from SDL Atlas L.L.C., 1813A Associate Lane, Charlotte NC 28217; tel: 704/329-0911; fax:

704/329-0914; e-mail: info@sdlatlas.com.

11.4 Clorox is labeled at a strength of 5.25% sodium hypochlorite. When purchased, the strength will be 5.25% or slightly higher. All sodium hypochlorite solutions lose strength in time. Strength loss is accelerated by exposure to light and heat. Do not use after 60 days from purchase. Clorox is a registered trademark of The Clorox Co., P.O. Box 24305, Oakland CA 94623; tel: 510/271-7000.

11.5 Calcium chloride, anhydrous, CaCl_2 , J. T. Baker Catalog No. 1308.

11.6 Magnesium chloride hexahydrate, $\text{MgCl}_2 \cdot 6\text{H}_2\text{O}$, J. T. Baker Catalog No. 2444.

11.7 Available from AATCC, P.O. Box 12215, Research Triangle Park NC 27709; tel: 919/549-8141; fax: 919/549-8933; e-mail: orders@aatcc.org.

11.8 Take a 100 mL (volumetric) sample of test solution. Add 20 mL of 6N sulfuric acid, 6 mL of 12% potassium iodide and 3 drops of 1% starch solution. Mix thoroughly; the solution should be brownish blue color. Back titrate with 0.01N sodium thiosulfate till the first disappearance of the blue starch indicator color. Calculate the available chlorine as follows:

% available chlorine =

$$\frac{\text{mL Na thiosulfate} \times 0.01N \times 0.0355}{100 \text{ mL} \times \text{sp. gr. Na hypochlorite}} \times 100$$

(Specific gravity of Clorox is 1.08. Using the above equation, the use of 1.6 mL of sodium thiosulfate in back titration would yield a result of 0.0005% or 5.0 ppm.)

11.9 Another evaluation method is to determine the Gray Scale grade from instrumental readings. There is a significant difference between grades using the two systems, with instrumental rating being more accurate (see AATCC Evaluation Procedure 7, Instrumental Assessment of the Change in Color of a Test Specimen). If instrumental grades are used, the procedure should be stated in the report.

Colorfastness: Dye Transfer in Storage; Fabric-to-Fabric

Developed in 1985 by Committee RR92; editorially revised and reaffirmed 1986, 1992, 1997, 2002; reaffirmed 1987; editorially revised 1995, 2001.

1. Purpose and Scope

1.1 The storage of garments made with component parts of more than one shade sometimes results in the transfer of dye from one area to another, normally from the darker to the lighter shade. This phenomenon is distinct from sublimation because it occurs below the sublimation temperature of dyes as well as with non-subliming dyes.

1.2 Dye transfer occurs when garments are folded with different shades in intimate contact with each other. Normally the amount of dye transferred is intensified when moisture is present, and thus the problem is more severe during warm, humid weather or when garments are steamed immediately before storage. Storage in plastic bags tends to maintain the initial relative humidity of the garment environment and can aggravate or reduce transfer depending on the condition of the fabric when it enters the bag.

1.3 This test method is intended to estimate if color transfer might be expected to occur during prolonged periods of storage. In general, no problems will be expected under normal conditions of storage or time-delay, if color transfer does not occur under the conditions specified in Section 7 (Procedure).

1.4 This test method may be used also to assess potential color transfer problems that relate to finishing. Some dyes are inherently more prone to transfer than others, and some chemical finishes and finishing conditions accelerate transfer.

2. Principle

2.1 Dyed and finished test specimens are sandwiched between pre-wet multifiber fabric and a selected second fabric, placed in a Perspiration Tester for 48 h at room temperature, dried and rated.

3. Terminology

3.1 **colorfastness**, n.—the resistance of a material to change in any of its color characteristics, to transfer of its colorant(s) to adjacent materials or both, as a result of the exposure of the material to any environment that might be encountered during the processing, testing, storage or use of the material.

3.2 **dye**, n.—a colorant applied to or formed in a substrate, via the molecularly dispersed state, which exhibits some degree of permanence.

3.3 **transfer**, n.—in *textile processing, testing, storage and use*, movement of a chemical, dye or pigment between fibers within a substrate or between substrates.

4. Safety Precautions

NOTE: These safety precautions are for information purposes and are not intended to be all inclusive. It is the user's responsibility to use safe and proper techniques in handling materials and equipment in this test method. Manufacturers MUST be consulted for specific details such as material safety data sheets and other manufacturer's recommendations. All OSHA standards and rules must also be consulted and followed.

4.1 Good laboratory practices should be followed. Wear safety glasses in all laboratory areas.

4.2 Manufacturer's safety recommendations should be followed when operating laboratory testing equipment.

4.3 Observe padder safety. Ensure adequate guard at the nip point. Normal safeguards on pad should not be removed. A foot-operated kickoff is recommended.

5. Apparatus and Materials

5.1 AATCC Perspiration Tester (see 11.1).

5.2 Plastic bag, polyethylene, large enough to contain Perspiration Tester. A Ziploc bag of suitable size may be used.

5.3 Multifiber Test Fabric No. 10 (see 11.1).

5.4 White fabric of same fiber composition as test specimens. If not available, cotton cloth as defined in AATCC Method 8.

5.5 Distilled or deionized water.

5.6 Evaporating dish or glass beaker having the capacity to hold 50 mL of water. Wet sponge may also be used.

5.7 Chromatic Transference Scale (see 11.1)

5.8 Gray Scale for Staining (see 11.1)

6. Test Specimens

6.1 Prepare 5.7 × 5.7 cm (2.25 × 2.25 in.) test specimens from each sample of the dyed fabric to be tested.

6.2 Prepare 5.7 × 5.7 cm (2.25 × 2.25 in.) multifiber and 5.7 × 5.7 cm (2.25 × 2.25 in.) white fabric swatches.

7. Procedure

7.1 Option I.

7.1.1 Immerse in distilled or deionized water at 24 ± 3°C (75 ± 5°F) both the multifiber fabric and the fabric selected for the opposite side of the sandwich (see 5.4). The wet pickup of these fabrics should be 100-110% (see 11.2). Do not wet out the specimen to be tested to prevent removal of dye or finish before testing begins.

7.1.2 Prepare a sandwich with the dyed test specimen between pre-wet multifiber cloth and the pre-wet white swatch (see 5.4).

7.1.3 Clamp the sandwich (prepared as directed in 7.1.2) between two clean plates of the Perspiration Tester. Set the Perspiration Tester as instructed in 8.4.1 of AATCC Method 15 except that the unit is not placed in an oven.

7.1.4 Enclose the Perspiration Tester in a polyethylene bag along with a dish (see 5.6) containing at least 50 mL of distilled or deionized water to maintain high relative humidity in the polyethylene bag. Seal the opening in the bag with a twist tie or rubberband if Ziploc bag is not used (see 5.2). Allow to remain 48 h at room temperature (24 ± 3°C). Take care that the Perspiration Tester does not fall into the water dish.

7.1.5 Remove the cover from the Perspiration Tester, remove the sandwiched specimens from the tester and separate the swatches. Allow the swatches to dry at room temperature.

7.2 Option II.

7.2.1 An accelerated test procedure has been used showing approximately the same results on some dyed or finished fabrics by placing the test apparatus (see 7.1.4) in a force draft oven at 38 ± 1°C (100 ± 2°F) for 4 h (see 11.3).

8. Evaluation

8.1 After the swatches are dried, examine the multifiber and the white cloth for color transfer. Rate each of the fiber types in the multifiber fabric and the swatch on the opposite side of the sandwich separately, according to the Chromatic Transference Scale or the Gray Scale for Staining (see 11.4). Record which scale was used.

Grade 5—negligible or no color transfer.

Grade 4.5—color transfer equivalent to Step 4-5 on the Gray Scale for Staining or Row 4.5 on the 9-step AATCC Chromatic Transference Scale.

Grade 4—color transfer equivalent to

Step 4 on the Gray Scale for Staining or Row 4 on the 9-step AATCC Chromatic Transference Scale.

Grade 3.5—color transfer equivalent to Step 3-4 on the Gray Scale for Staining or Row 3.5 on the 9-step AATCC Chromatic Transference Scale.

Grade 3—color transfer equivalent to Step 3 on the Gray Scale for Staining or Row 3 on the 9-step AATCC Chromatic Transference Scale.

Grade 2.5—color transfer equivalent to Step 2-3 on the Gray Scale for Staining or Row 2.5 on the 9-step AATCC Chromatic Transference Scale.

Grade 2—color transfer equivalent to Step 2 on the Gray Scale for Staining or Row 2 on the 9-step AATCC Chromatic Transference Scale.

Grade 1.5—color transfer equivalent to Step 1-2 on the Gray Scale for Staining or Row 1.5 on the 9-step AATCC Chromatic Transference Scale.

Grade 1—color transfer equivalent to Step 1 on the Gray Scale for Staining or Row 1 on the 9-step AATCC Chromatic Transference Scale.

9. Report

9.1 Identify the white fabric used in the

sandwich (see 5.4 and 11.5).

9.2 Report the moisture pickup if other than 100-110% (see 11.2).

9.3 Report which rating scale was used.

9.4 Report the stain grade for each fiber type in the multifiber fabric and also the grade on the white swatch, as a dye transfer grade.

10. Precision and Bias

10.1 *Interlaboratory Data.* An interlaboratory comparison was run in 1982 in which samples from two different textile materials were tested in each of four laboratories, each material having five different finishes. Both the AATCC Chromatic Transference Scale and the Gray Scale for Staining were used and a correlation within one unit was established between laboratories.

10.2 *Precision.* Based on the observations described in 10.1 and on general practice in the trade, a lot or consignment is generally considered as having a rating that is significantly worse than a specified value when a specimen from the lot or consignment has a rating of dye transfer that is more than one unit below the

specified rating on the Gray Scale for Staining.

10.3 *Bias.* The true value of dye transfer can only be defined in terms of a test method. Within this limitation, this method has no known bias.

11. Notes

11.1 For procurement see listings under "Special Equipment and Materials Used in AATCC Test Methods" in the AATCC TECHNICAL MANUAL.

11.2 With some fabrics and constructions, 100% pickup causes a dripping wet condition. For those materials, use the highest pickup that is possible without water dripping from the specimen when it is suspended.

11.3 If any temperature and/or time other than those specified in 7.2 are used, report the change and reason for same.

11.4 For very critical evaluation and in case of arbitration, rating must be based on the geometric gray scale for evaluating staining.

11.5 All materials are not affected equally. Results obtained by the use of any one test procedure should not be representative of those of any other test procedure unless the degree of quantitative correlation for a given material has been established. In any event, the test procedure should be described in a material specification.

Colorfastness to Oxides of Nitrogen in the Atmosphere under High Humidities

Developed in 1985 by AATCC Committee RA33; editorially revised and reaffirmed 1986, 1997; reaffirmed 1987, 1992, 2001; editorially revised 1989, 1995, 2004. Technically equivalent to ISO 105-G04.

1. Purpose and Scope

1.1 This test method is used to determine the resistance of the color of textiles to the action of oxides of nitrogen in the atmosphere at elevated temperatures with relative humidities above 85%.

1.2 On certain fibers, dyes do not readily fade at humidities below 85%. Testing at higher humidities is required to produce color changes that predict service fading under warm, humid conditions (see 11.1).

2. Principle

2.1 A test specimen and a swatch of control ribbon are simultaneously exposed to oxides of nitrogen in an atmosphere which is maintained at $87.5 \pm 2.5\%$ RH and a temperature of $40 \pm 1^\circ\text{C}$ ($104 \pm 2^\circ\text{F}$) until the control ribbon shows a color change corresponding to that of a standard of fading. The cycles are repeated until the specimen shows a definite color change or for a prescribed number of cycles.

3. Terminology

3.1 **colorfastness, n.**—the resistance of a material to change in any of its color characteristics, to transfer of its colorant(s) to adjacent materials or both, as a result of the exposure of the material to any environment that might be encountered during the processing, testing, storage or use of the material.

4. Safety Precautions

NOTE: These safety precautions are for information purposes only. They are ancillary to the testing procedures and are not intended to be all inclusive. It is the user's responsibility to use safe and proper techniques in handling materials in this test method. Manufacturers MUST be consulted for specific details such as material safety data sheets and other manufacturer's recommendations. All OSHA standards and rules must also be consulted and followed.

4.1 Oxides of nitrogen in high concen-

trations are injurious to health and must be exhausted to the atmosphere or trapped in water and neutralized with a 10% solution of sodium hydroxide or sodium bicarbonate. The maximum concentration in a work area must not exceed 500 pphm.

4.2 Chain or clamp the gas cylinder to a wall or other suitable support so that it cannot fall or be knocked down.

4.3 Exposure to chemicals used in this procedure must be controlled at or below levels set by governmental authorities (e.g., Occupational Safety and Health Administration's [OSHA] permissible exposure limits [PEL] as found in 29 CFR 1910.1000 of January 1, 1989). In addition, the American Conference of Governmental Industrial Hygienists (ACGIH) Threshold Limit Values (TLVs) comprised of time weighted averages (TLV-TWA), short term exposure limits (TLV-STEL) and ceiling limits (TLV-C) are recommended as a general guide for air contaminant exposure which should be met (see 11.2).

5. Apparatus and Materials

5.1 Exposure chamber suitable for containing oxides of nitrogen (NO_2) and maintaining a constant elevated temperature and relative humidity (see 11.3).

5.2 Control Ribbon No. 1 (see 11.4).

5.3 Standard of Fading (Ribbon No. 1) (see 11.4).

5.4 Gray Scale for Color Change (see 11.5).

5.5 Oxides of nitrogen supply tank (see 11.6).

6. Test Specimens

6.1 Cut each specimen at least 60×60 mm. For subsequent color comparison, the unexposed sample should be kept in an airtight container away from light to avoid further shade changes.

6.2 If the test involves laundered or drycleaned material, launder or dryclean material for both the control and test specimens. For the preparation of specimens for testing after laundering or drycleaning, follow the procedures prescribed in AATCC Methods 61, Colorfastness to Laundering, Home and Commercial: Accelerated, and/or 132, Colorfastness to Drycleaning.

7. Procedure

7.1 Suspend the test specimens and a swatch of Control Ribbon No. 1 in the exposure chamber which is maintained at $87.5 \pm 2.5\%$ RH and a temperature of $40 \pm 1^\circ\text{C}$ ($104 \pm 2^\circ\text{F}$). NO_2 concentrations must range from 400-600 pphm which should produce a cycle of fade within 5-15 h of exposure.

7.2 Examine the Control Ribbon No. 1 periodically until its color corresponds to that of the standard of fading when compared in daylight ranging from average to slightly bluish north skylight or equivalent artificial light. This constitutes one cycle.

7.2.1 An alternative method of determining one cycle of fade is to terminate the exposure cycle when the Control Ribbon No. 1 exhibits a color change of 16.5 ± 1.5 CIELAB units for Lot 16 (see 11.7).

7.3 Remove those specimens which exhibit a noticeable color change at the end of one cycle. One cycle will generally produce a measurable color change in specimens which are sensitive to oxides of nitrogen.

7.4 Suspend an unexposed swatch of Control Ribbon No. 1 for each additional cycle of fade until the required number of cycles have been completed.

7.5 Optional Aftertreatment

7.5.1 Specimens exposed to oxides of nitrogen might continue to change color after removal from the test chamber. The color may be stabilized by plunging the specimens into a buffered urea solution (see 11.8) for 5 min. They should then be squeezed, thoroughly rinsed in clean water and dried in air at a temperature not above 60°C (140°F). CAUTION: Do not treat any specimen with the urea solution that must be returned to the test chamber for additional exposure.

8. Evaluation

8.1 At the end of each cycle, immediately compare those specimens which are removed from the exposure chamber with the preserved originals from which they are drawn.

8.2 Rate the effect on color of test specimens after any specified number of cycles by reference to the Gray Scale for Color Change, and report the number of cycles run as follows:

Grade 5—negligible or no change as

shown in Gray Scale Step 5.

Grade 4.5—change in color equivalent to Gray Scale Step 4-5.

Grade 4—change in color equivalent to Gray Scale Step 4.

Grade 3.5—change in color equivalent to Gray Scale Step 3-4.

Grade 3—change in color equivalent to Gray Scale Step 3.

Grade 2.5—change in color equivalent to Gray Scale Step 2-3.

Grade 2—change in color equivalent to Gray Scale Step 2.

Grade 1.5—change in color equivalent to Gray Scale Step 1-2.

Grade 1—change in color equivalent to Gray Scale Step 1.

9. Report

9.1 Report the numerical grade for the change in color of the test specimen, the number of cycles run, the temperature and relative humidity at which the test was performed.

10. Precision and Bias

10.1 *Precision.* Precision for this test method has not been established. Until a precision statement is generated for this method, use standard statistical techniques in making any comparisons of test results for either *within-laboratory* or *between-laboratory* averages.

10.2 *Bias.* Colorfastness to oxides of nitrogen in the atmosphere under high humidities can be defined only in terms of a test method. There is no independent method for determining the true values. As a means of estimating these properties, the method has no known bias.

11. Notes

11.1 **Humidity for Testing.** The fading of

dyes by oxides of nitrogen on some fibers such as nylon and acetate is altered greatly by relatively small variations in relative humidity at high humidities. Therefore closely control temperature and relative humidity.

11.2 Available from Publications Office, ACGIH, Kemper Woods Center, 1330 Kemper Meadow Dr., Cincinnati OH 45240; tel: 513/742-2020.

11.3 **Exposure Chamber.** The oxides of nitrogen chamber for elevated temperatures and relative humidities above 85% should be made of stainless steel which has been coated on the inside with a resistant coating. It must maintain the conditions of $87.5 \pm 2.5\%$ RH, $40 \pm 1^\circ\text{C}$ ($104 \pm 2^\circ\text{F}$) temperature and contain an NO_2 concentration between 400-600 ppm.

11.3.1 Blueprints of a suitable apparatus are available from AATCC, P.O. Box 12215, Research Triangle Park NC 27709; tel: 919/549-8141; fax: 919/549-8933; e-mail: orders@aatcc.org.

11.3.2 Apparatus for measuring NO_2 concentration is commercially available from several manufacturers including the following: Beckman Instruments Inc., 2500 Harbor Blvd., Fullerton CA 92634; Mast Development, 2212 East 12th St., Davenport IA 52803.

11.4 Test Control and Standard of Fading.

11.4.1 The Test Control Fabric, Control Ribbon No. 1, is a dyeing of 0.400% C.I. Disperse Blue 3 on secondary acetate satin. Celliton Blue FFRN is used since its fading characteristics are well known and other C.I. Disperse Blue 3 dyes tend to exhibit different fading characteristics and may differ in tinctorial strength.

11.4.2 The Standard of Fading for Control Ribbon No. 1 is dyed on rayon satin with the following formula: 0.300% C.I. Direct Blue 80 and 0.015% C.I. Direct Violet 47 based on the weight of the fabric.

11.4.3 Both the control fabric and the standard of fading must be kept in suitable containers or enclosures to protect them from possible exposure and color change to oxides of nitrogen and other contaminants which might be present in the atmosphere during transportation and storage.

11.4.4 The control fabric is also sensitive to other atmospheric contaminants such as

ozone. Its fading rate will vary considerably at different humidities and temperatures and its use in natural or end-use testing as a measure of exposures to oxides of nitrogen is not recommended. The color change produced on the control will reflect the combined effects of the atmospheric contaminants present and temperature-humidity variations, not just the effects of exposure to oxides of nitrogen.

11.4.5 A sealed unit of Control Ribbon No. 1 comprising 18 m (20 yd) of ribbon 50 mm (2 in.) wide with a specific lot number indicated and a specimen of the Standard of Fading for that lot of control fabric is available as Control Sample No. 1 from Testfabrics Inc., P.O. Box 26, 415 Delaware St., W. Pittston PA 18643; tel: 570/603-0432; fax: 570/603-0433; e-mail: testfabric@aol.com.

11.5 Available from AATCC, P.O. Box 12215, Research Triangle Park NC 27709; tel: 919/549-8141; fax: 919/549-8933; e-mail: orders@aatcc.org.

11.6 Use bottled gas which contains approximately 1% NO_2 in nitrogen in cylinders equipped with the proper reducing valves.

11.7 Make colorimetric or spectrophotometric measurements of the Control Ribbon No. 1 with the specular component included. Calculate colorimetric data using the CIE 1964 10° observer data for Illuminant D_{65} . Express the color difference in CIELAB units as per AATCC Evaluation Procedure 6, Instrumental Color Measurement.

11.8 Urea Aftertreatment.

11.8.1 The use of this treatment is completely optional. Experience has shown that color change after removal of specimens from the exposure chamber is negligible. The urea treatment itself will often cause a color change in specimens. Therefore, if this procedure is used, it is essential that both the exposed and unexposed control specimens be treated in an identical manner.

11.8.2 Urea Solution: 10 g of urea ($\text{NH}_2 \cdot \text{CO} \cdot \text{NH}_2$) per liter of water buffered to pH7 by addition of 0.4 g of sodium dihydrogen orthophosphate ($\text{NaH}_2\text{PO}_4 \cdot 2\text{H}_2\text{O}$) and 2.5 g of disodium hydrogen orthophosphate ($\text{Na}_2\text{HPO}_4 \cdot 12\text{H}_2\text{O}$) and 0.1 g or less of a rapid wetting surface active agent; for example, sodium dioctyl sulfosuccinate.

Colorfastness to Crocking: Textile Floor Coverings— AATCC Crockmeter Method

Developed in 1986 by AATCC Committee RA57; reaffirmed 1987, 1988; editorially revised and reaffirmed 1993; revised 1999 (with title change); editorially revised 1996, 2001, 2002, 2004. Partly equivalent to ISO 105-X12.

1. Purpose and Scope

1.1 This test method is designed to determine the degree of color transfer from the surface of textile floor coverings to other surfaces by rubbing. The intent is to reproduce as near as possible true-to-life situations in all constructions whether dyed, printed or otherwise colored.

1.2 Test procedures employing white test cloths, both dry and wet with water, are given.

1.3 As the use surface of a textile floor covering may be exposed to various conditions in true-to-life situations, such as soil, stains, cleaning, shampooing and application of chemical treatments such as antisoils, antistats, antimicrobials, etc., the test may be made before, after or before and after such situations.

2. Principle

2.1 A colored test specimen held on the base of a crockmeter is rubbed with a white test cloth under controlled conditions.

2.2 Color transferred to the white test cloth is rated by comparison with the AATCC Chromatic Transference Scale or Gray Scale for Staining and a grade is assigned.

3. Terminology

3.1 **carpet, n.**—all textile floor coverings not designated as rugs.

3.2 **colorfastness, n.**—the resistance of a material to change in any of its color characteristics, to transfer of its colorant(s) to adjacent materials or both, as a result of the exposure of the material to any environment that might be encountered during the processing, testing, storage or use of the material.

3.3 **crocking, n.**—a transfer of colorant from the surface of a colored yarn or fabric to another surface or to an adjacent area of the same fabric principally by rubbing.

3.4 **rug, n.**—a textile floor covering of limited area which is complete in itself and is intended for use as a partial covering of a floor or another floor covering.

3.5 **textile floor covering, n.**—an arti-

cle having a use-surface composed of textile material and generally used for covering floors.

3.6 **use-surface, n.**—of *textile floor covering*, the part of a textile floor covering directly exposed to foot traffic.

4. Safety Precautions

NOTE: These safety precautions are for information purposes only. These safety precautions are ancillary to the testing procedures and are not intended to be all inclusive. It is the user's responsibility to use safe and proper techniques in handling materials in this test method. Manufacturers MUST be consulted for specific details such as material safety data sheets and other manufacturer's recommendations. All OSHA standards and rules must also be consulted and followed.

4.1 Good laboratory practices should be followed. Wear safety glasses in all laboratory areas.

5. Apparatus and Materials

5.1 AATCC Crockmeter (see 13.1, 13.2).

5.2 AATCC Crock Block (see 13.2).

5.3 Crockmeter Test Cloth (see 13.3).

5.4 AATCC Chromatic Transference Scale (see 13.4).

5.5 Gray Scale for Staining (see 13.4).

5.6 White AATCC Textile Blotting Paper (see 13.4).

6. Test Specimens

6.1 Two specimens are used, one each for the dry and the wet tests.

6.1.1 Additional specimens may be used to increase the precision of the average.

6.2 Floor covering material: pieces at least 50 × 150 mm. If the pile lay is distinguishable, cut the specimen with the pile lay pointing in the long direction.

6.2.1 Larger or full width lab samples may be used without cutting individual specimens, when multiple tests are needed and when using for production testing.

7. Verification

7.1 Verification checks on the operation of the test and the apparatus should be made routinely and the results kept in a log. The following observations and corrective actions are extremely important to avoid incorrect test results where

abnormal crock images can result and influence the rating process.

7.2 Use an in-house poor crocking carpet or rug as a calibration specimen and conduct three dry crock tests.

7.2.1 A double, elongated image may indicate a loose sleeve.

7.2.2 A stretched and streaked crock image may be due to mounting the crock test cloth diagonally.

7.2.3 Arc shaped indentions in the crocked area of the test cloth may indicate the crock block is mounted improperly, most likely perpendicular to the specified placement (see 13.2).

7.3 Replace the abrasive paper on the tester base if it is smooth to the touch in the crocking area compared to the adjacent area, or if slippage of the specimen is noticed.

8. Conditioning

8.1 Prior to testing, condition the test specimens and the crock test cloth for dry crock testing as directed in ASTM D 1776, Standard Practice for Conditioning and Testing Textiles. Condition each specimen for at least 4 h in an atmosphere of 21 ± 1°C and 65 ± 2% RH by laying each test specimen or crock test cloth separately on a screen or perforated shelf of conditioning rack.

9. Procedures

9.1 Dry Crocking Test.

9.1.1 Place a test specimen on the base of the crockmeter so that it rests flat on the abrasive cloth with its long dimension in the direction of rubbing (see 13.5). The pile lay should point to the back of the crockmeter if direction of pile is distinguishable.

9.1.2 Mount a 25 × 100 mm swatch of white cotton test cloth over the rubbing surface of the crock block. The test cloth should be mounted so that the long dimension will be moving in the long direction during the test. This operation can be carried out with the crock block attached to the weighted arm of the crockmeter using an Allen socket cap screw (see 13.6) or with the crock block detached from the arm and inverted in a suitable crock block holder (see 13.2 and 13.7). Fasten the test cloth to the crock block by means of a rectangular sleeve that slips over the cotton fabric on the crock block. When ready for testing, the test cloth on the crock block projects downward from the

reciprocating arm of the crockmeter.
Caution: Do not drop the crock block. Nicks or dents on the rubbing surfaces might be irreparable. **Handle With Care.**

9.1.3 Lower the covered crock block gently onto the test specimen. While holding the specimen firmly with extended thumb and forefinger of the left hand, execute ten (10) complete turns of the crank at the rate of one (1) turn per s.

9.1.4 Remove the white test cloth, condition (see 8.1) and evaluate as directed in Section 10. In the case of napped, brushed or sheared material when loose fiber might interfere with the ratings, remove the extraneous fibrous material by pressing lightly on the crock area with the sticky side of cellophane tape before evaluating.

9.2 Wet Crocking Test.

9.2.1 Thoroughly wet the white test cloth in distilled water.

9.2.2 By any convenient means, such as squeezing between filter papers through a hand wringer, bring the wet pickup to $65 \pm 5\%$ based on the conditioned weight of the dry test cloth under standard conditions ($21 \pm 1^\circ\text{C}$ and $65 \pm 2\%$ RH) before testing (see 13.8).

9.2.3 Take care to prevent evaporation which would reduce the moisture content below the specified level before the actual crock test is run.

9.2.4 Continue testing as directed in 9.1.

9.2.5 Air-dry the test cloth before evaluating. In the case of napped, brushed or sheared material when loose fiber might interfere with the rating, remove the extraneous fibrous material by pressing lightly on the test cloth with the sticky side of cellophane tape before evaluating.

10. Evaluation

10.1 Evaluate the amount of color transferred from the specimen to the white test cloth under examination by means of the AATCC Chromatic Transference Scale or the Gray Scale for Staining (see 13.4).

10.2 Place the test cloth on three layers of clean white cloth for the evaluation.

10.3 Classify dry and wet fastness to crocking. Different ratings may result depending upon whether the Gray Scale for Staining or AATCC Chromatic Transference Scale is used for the evaluation. It is, therefore, important to report which scale was used. For very critical evaluations and in cases of arbitration, ratings must be based on the Gray Scale for Staining:

Grade 5—negligible or no color transfer.

Grade 4.5—color transfer equivalent to Step 4-5 on the Gray Scale for Staining or Row 4.5 on the 9-step AATCC Chromatic Transference Scale.

Grade 4—color transfer equivalent to

Step 4 on the Gray Scale for Staining or Row 4 on the 9-step AATCC Chromatic Transference Scale.

Grade 3.5—color transfer equivalent to Step 3-4 on the Gray Scale for Staining or Row 3.5 on the 9-step AATCC Chromatic Transference Scale.

Grade 3—color transfer equivalent to Step 3 on the Gray Scale for Staining or Row 3 on the 9-step AATCC Chromatic Transference Scale.

Grade 2.5—color transfer equivalent to Step 2-3 on the Gray Scale for Staining or Row 2.5 on the 9-step AATCC Chromatic Transference Scale.

Grade 2—color transfer equivalent to Step 2 on the Gray Scale for Staining or Row 2 on the 9-step AATCC Chromatic Transference Scale.

Grade 1.5—color transfer equivalent to Step 1-2 on the Gray Scale for Staining or Row 1.5 on the 9-step AATCC Chromatic Transference Scale.

Grade 1—color transfer equivalent to Step 1 on the Gray Scale for Staining or Row 1 on the 9-step AATCC Chromatic Transference Scale.

11. Report

11.1 Identify the sample tested.

11.2 Report the grade determined in

10.3.

11.3 Indicate whether dry or wet crocking was performed.

11.4 Indicate whether Gray Scale for Staining or AATCC Chromatic Transference Scale was used for evaluating crocking (see 10.3).

11.5 If the carpet or rug was subjected to the conditions in 1.3 state this in the report.

12. Precision and Bias

12.1 *Precision.* An interlaboratory test was conducted in 1997 to establish the precision of the test method. Testing was conducted under the normal atmospheric conditions of each laboratory and not necessarily under ASTM standard conditions. Two operators at each of four laboratories tested and rated six fabrics on two consecutive days, both wet and dry crock. Rating was performed using the Gray Scale for Staining and the AATCC Chromatic Transference Scale.

12.1.1 The results for one operator chosen from each laboratory were evaluated in an ANOVA two factor with replication analysis. The components of variance are given in Table I.

12.1.2 Critical differences are given in Table II.

Table I—Components of Variance

	Dry		Wet	
	Gray	Chromatic	Gray	Chromatic
Within-Laboratory	0.0312	0.0417	0.125	0.0938
Interaction	0.0135	0.0403	-0.0201	-0.0031
Between-Laboratory	0.0264	0.0101	0.0028	0.0031

Table II—Critical Differences

For the components of variance in Table I, two averages of observed values should be considered significantly different at the 95% probability level if the difference equals or exceeds the following critical differences.

	No. of Observation	Single Fabric			
		Dry		Wet	
		Gray	Chromatic	Gray	Chromatic
Within-Laboratory	1	0.49	0.56	0.98	0.85
	3	0.28	0.33	0.68	0.49
	5	0.22	0.25	0.44	0.38
Between-Laboratory	1	0.66	0.63	0.99	0.86
	3	0.53	0.43	0.58	0.51
	5	0.50	0.38	0.46	0.41
	No. of Observation	Multiple Fabric			
		Dry		Wet	
		Gray	Chromatic	Gray	Chromatic
Within-Laboratory	1	0.59	0.79	0.98	0.85
	3	0.43	0.64	0.68	0.49
	5	0.39	0.61	0.44	0.38
Between-Laboratory	1	0.74	0.84	0.99	0.86
	3	0.62	0.70	0.58	0.51
	5	0.60	0.67	0.46	0.41

12.1.3 Example for determining between-laboratory differences using one observer and the Chromatic Scale are given in Table III.

Table III—Crock Test Results

	Dry	Wet
Laboratory A	4.0	4.0
Laboratory B	3.5	3.0
Difference	0.5	1.0

Interpretation: For the dry crock test, because the difference between labs is less than the critical difference in 12.1.2 (0.63), the difference in results is not significant. For the wet crock test, since the difference is greater than the critical difference (0.86), the difference in results is significant.

12.2 *Bias*. The true value of colorfastness to crocking can only be defined in terms of a test method. Within this limitation, this test method has no known bias.

13. Notes

13.1 The AATCC Crockmeter provides a reciprocating rubbing motion simulating the action of a human finger and forearm. The counting device is useful when prolonged rubbings are required and is available at extra cost.

13.2 The AATCC Crockmeter is so designed that the crock block with rectangular

rubbing surface 19.0 × 25.4 mm moves to and fro, with each complete turn of the crank along a straight path approximately 100 mm in length on a textile floor covering specimen with a downward force in the order of 9 Newtons. The crock block must be mounted in one direction only; a cutout in the side of the stem receives the screw that holds it in the reciprocating arm. The flat head screw can be replaced by an Allen socket cap screw (see 13.6) or similar device that can be tightened and released by hand. A crock block holder can also be used to assist in the mounting of the cotton test cloth if so desired. Note that, with the rectangular slip-on sleeve provided with the crock block, the test cloth can be mounted with ease and speed while the crock block is still attached to the weighted arm of the crockmeter. The AATCC Crockmeter and accessories can be purchased from SDL Atlas L.L.C., 1813A Associate Lane, Charlotte NC 28217; tel: 704/329-0911; fax: 704/329-0914; e-mail: info@sdlatlas.com.

13.3 Crockmeter Test Cloth is available from Testfabrics Inc., P.O. Box 26, 415 Delaware St., W. Pittston PA 18643; tel: 570/603-0432; fax: 570/603-0433; e-mail: testfabric@aol.com; Textile Innovators Corp., div. of SDL Atlas L.L.C., P.O. Box 8, 101 Forest St., Windsor NC; tel: 252/794-9703; fax: 252/794-9704; e-mail: tic@sdlatlas.com.

13.3.1 Crockmeter Test Cloth should meet the following specifications:

Fiber	100%	10.3-16.8 mm
	combed cotton staple, desized, bleached, with no optical brightener or finishing material present	

Yarn	15 tex (40/1 cotton count), 5.9 turns/cm "z"
Thread count	32 ± 3 warp ends/cm; 33 ± 3 filling picks/cm
Weave	1/1 plain
pH	7 ± 0.5
Mass/sq meter	113 ± 5 g greige; 100 ± 3 g finished
Whiteness	W = 80 ± 2 (AATCC Method 110)

13.4 AATCC Chromatic Transference Scale, Gray Scale for Staining and White AATCC Textile Blotting Paper are available from AATCC, P.O. Box 12215, Research Triangle Park NC 27709; tel.: 919/549-8141; fax: 919/549-8933; e-mail: orders@aatcc.org.

13.5 The abrasive material currently supplied with the Crockmeter is Wet or Dry Waterproof Silicone Carbide, W-320-A. Replacement pieces are available from SDL Atlas L.L.C., 1813A Associate Lane, Charlotte NC 28217; tel: 704/329-0911; fax: 704/329-0914; e-mail: info@sdlatlas.com.

13.6 Allen socket head cap screw, 10-32 threads, 20 mm long.

13.7 A crock block holder is simply a weighted block with a hole bored in the top to accommodate the 16 mm diameter stem of the crock block when the latter has been inverted for mounting of the test cloth.

13.8 Experienced operators do not have to repeat this weighing procedure during a test session once the technique is established.

Foaming Propensity of Disperse Dyes

Developed in 1986 by AATCC Committee RA87; reaffirmed 1987, 1988, 1993, 1998, 2003; editorially revised 1989, 1991, 1997.

1. Purpose and Scope

1.1 Foam generation must be controlled in dyeing equipment such as jet machines which operate with high circulation and high agitation of the dye liquor at low bath ratios.

1.2 This test method provides a standard for measuring the foaming properties of disperse dye under controlled conditions and determines the relative contribution of a single disperse dye to generate dyebath foam.

2. Principle

2.1 A quantity of disperse dye is prediluted, preheated and placed in a regular kitchen blender (see 12.4). Using a predetermined blender speed, the dye dispersion is blended for a specific time, transferred to a glass graduated cylinder and the foam and liquid levels are measured.

3. Terminology

3.1 **foam, n.**—a dispersion of a gas in a liquid or solid (see 12.2).

4. Safety Precautions

NOTE: These safety precautions are for information purposes only. The safety precautions are ancillary to the testing procedures and are not intended to be all inclusive. It is the user's responsibility to use safe and proper techniques in handling materials in this test method. Manufacturers must be consulted for specific details such as material data sheets and other manufacturer's recommendations. All OSHA standards and rules must also be consulted and followed.

4.1 Handle all chemicals carefully. Use chemical goggles or face shield, impervious gloves and an impervious apron when handling the chemicals used in this procedure. An eyewash/safety shower should be located nearby for emergency use.

4.2 Wear safety glasses and a dust mask when handling powdered dyestuff.

4.3 If concentrated acetic acid is diluted to prepare the acetic acid for pH adjustment (7.1.4), use chemical goggles or face shield, impervious gloves and an im-

pervious apron during preparation. Handle concentrated acids only in an adequately ventilated laboratory hood. An eyewash/safety shower should be located nearby for emergency use. CAUTION: Always add acid to water.

4.4 Exposure to chemicals used in this procedure must be controlled at or below levels set by governmental authorities [e.g., Occupational Safety and Health Administration's (OSHA) permissible exposure limits (PEL) as found in 29 CFR 1910.1000 of January 1, 1989]. In addition, the American Conference of Governmental Industrial Hygienists (ACGIH) Threshold Limit Values (TLVs) comprised of Time Weighted Averages (TLV-TWA), short term exposure limits (TLV-STEL) and ceiling limits (TLV-C) are recommended as a general guide for air contaminant exposure which should be met (see 12.3).

5. Uses and Limitations

5.1 The test method provides a means of comparing lot-to-lot variation of foam generation in dye shipments versus a control or standard reference sample of the same dye.

5.2 The test procedure is not complex, uses readily available equipment and provides results that correlate with results from other more elaborate lab dye testing equipment (see 12.1).

5.3 The test method offers a specific procedure and set of conditions that are useful for comparative studies by an individual laboratory. Variability between laboratories using different equipment and operators can produce slightly different measurements but will distinguish among low, moderate and high foaming disperse dyes.

5.4 Variables which affect accuracy and reproducibility of the test are specified in the notes (see 12.5, 12.6 and 12.7).

6. Apparatus and Materials

6.1 Equipment:

6.1.1 500 mL glass graduated cylinder.

6.1.2 Kitchen blender (see 12.4).

6.1.3 Glass blender container.

6.1.4 Stopwatch.

6.1.5 pH meter

6.2 Materials:

6.2.1 Distilled water.

6.2.2 Acetic acid, 10% solution.

6.2.3 1993 AATCC Standard Reference Detergent WOB.

7. Preparation

7.1 Prepare dye dispersion.

7.1.1 Weigh out 5 g of 100% strength dye. (For other dye strengths adjust accordingly. Example: 200% strength dye—weigh 2.5 g.)

7.1.2 Paste dye in 25 mL distilled water in a 400 mL beaker.

7.1.3 Further dilute the dispersion with 175 mL of distilled water and heat to 50°C (122°F) while stirring.

7.1.4 Dilute dye dispersion to 1 L with distilled water. Using a pH meter, adjust to pH 5.5 ± 0.2 with acetic acid (see 12.5). Final temperature of dispersion should be 30°C (86°F) for the test.

7.2 Prepare detergent solution.

7.2.1 Prepare a 0.5 g/L solution of 1993 AATCC Standard Reference Detergent WOB in tap water at 30°C (86°F) to check for any blender contamination that would prevent foaming.

7.3 Check the blender for contamination.

7.3.1 Pour 200 mL of detergent solution in clean 1.4 L (1.5 qt) capacity container of the blender.

7.3.2 Operate the blender at its highest speed for 30 s and then stop it. Allow the dispersion to stand for 30 s. A minimum of 2.5 cm of foam should be present on top of the solution. If less foam is present, clean the container and repeat the procedure until enough foam is generated (see 12.6).

7.3.3 Thoroughly rinse the blender container and add 200 mL of distilled water.

7.3.4 Operate the blender for 30 s at highest speed and then stop it. No foam should be present after 30 s. If foam is present, rinse the blender container thoroughly and repeat the procedure until no foam is present.

8. Foam Test

8.1 Pour 200 mL of dye dispersion into the blender container. Place a lid on the container.

8.2 Select blender speed which corresponds to the blade speed 14,000-15,000 rpm, usually highest speed of blender (see 12.4).

8.3 Start the stopwatch simultaneously with starting the blender. Hold the container, but not the lid, to prevent any spills.

8.4 After 30 s, stop the blender but allow the stopwatch to continue running.

8.5 Immediately pour the contents of the blender into a dry 500 mL graduated

cylinder. When pouring, tilt the container only once, and allow the dye dispersion and foam to freely flow into the cylinder. Keep the container tilted over the cylinder until 60 s have elapsed on the stopwatch. Then remove the container.

8.6 After 150 s, read the bottom of the meniscus of both the foam and liquid levels in the cylinder. The reading will be erroneous if the top of the foam which clings to the sides of the cylinder is read as the foam level (see 12.8).

8.7 Record the volume of foam and liquid volume and subtract the liquid volume to determine the mL of foam produced.

9. Evaluation

9.1 Rate dyes according to following classifications:

Class A: 0-30 mL—Very Low Foam

Class B: 31-60 mL—Low Foam

Class C: 61-90 mL—Moderate Foam

Class D: 91-120 mL—High Foam

Class E: Greater than 120 mL—Very High Foam

10. Report

10.1 Report the class (see 9.1) for each dye tested.

10.2 A standard, control or reference sample of the same product should be tested and reported under the same conditions if the test is used for lot-to-lot comparisons of the dye.

11. Precision and Bias

11.1 *Precision Between-Laboratories.* Interlaboratory testing of 14 dyes by five laboratories in 1982 was conducted with a single operator in each laboratory making two tests with each dye. A standard deviation of 7.8 was calculated for the study, but some laboratories had data that were significantly different from others. Blender speed was the major contributor to variation in test results. Blender speeds

can vary with both model of blender and line voltage; there is even 10-15% variation in speed between blenders from the same manufacturer. Therefore, the test is not suggested for comparison between laboratories because variations were larger than expected.

11.2 *Precision Within-Laboratory.* The standard deviation of low, moderate and high foam dyes as evaluated by a single operator was determined by conducting five tests with each of five dispersions of each dye. Using a Duncan's multiple range test for variable value, less than 0.1% of the total variation is due to dispersion preparation. About 1.2% of the total variation is due to the test. Of the total variation, 98.7% is due to foam level. The test will distinguish with 95% confidence level or higher between low, moderate and high foam generating disperse dyes. Multiple dispersions of the same dye are not necessary. Unless test results are significantly different from those expected, multiple tests of the same dye dispersion are not necessary. Listed below are the standard deviations of low, moderate and high foam generating disperse dyes:

Dye Type	Standard Deviation (mL foam)
Low Foam	2.04
Moderate Foam	4.85
High Foam	9.16

11.3 *Bias.* No statement on bias can be made since the true value cannot be established by an independent method.

12. Notes

12.1 The Gaston County Lab Dye Tester gives very good correlation with the blender test using 30°C (86°F) and ambient pressure. The apparatus should first be checked to be sure that contaminants that could affect foam levels are not present. A suggested procedure to measure foam is listed below.

12.1.1 Prepare a dye dispersion as described in the blender test except use 2 L of

distilled water and 10 g of disperse dye.

12.1.2 Adjust the dye dispersion to pH 5.5 with acetic acid and raise the temperature to 30°C (86°F).

12.1.3 Circulate the dye dispersion for 30 s.

12.1.4 Move machine function switch to STAND BY which stops dye dispersion circulation.

12.1.5 After an additional 30 s, measure the foam volume.

12.1.6 For information regarding the Gaston County Lab Dye Tester, contact Gaston County Dyeing Machine Co., P.O. Box 308, Stanley NC 28164; tel: 704/822-5000; fax: 704/827-0476.

12.2 The mass of bubbles formed by agitation of a dye dispersion in a regular kitchen blender is very similar to that which dyers commonly observe on the surface of highly agitated dyebaths.

12.3 Available from Publications Office, ACGIH, Kemper Woods Center, 1330 Kemper Meadow Dr., Cincinnati OH 45240; tel: 513/742-2020.

12.4 A standard kitchen blender such as Waring, Osterizer, Hamilton Beach or other readily available kitchen blenders having an agitator blade speed selection of 14,000-15,000 rpm can be used. Blade speed selection can be determined by consulting the manufacturer, but is usually near the highest speed selection.

12.5 Measure pH with a pH meter rather than pH paper or liquid indicators. Excess acetic acid producing pH values in the range of 3.5-4.5 can significantly increase the foam generated by some disperse dyes.

12.6 Excess silicone lubricants in the bearing of the agitator blade of the blender in new propeller assemblies can cause defoaming action. In such cases, rinse the assembly in an appropriate solvent to remove the lubricants.

12.7 Reproducible readings for foam generation are best taken at a 120-180 s interval after blending rather than the 60 s or less. A 60-s reading is too variable because some dyes require longer foam-liquid separation time than others.

12.8 A detailed description of the development of this procedure can be found in the 1982 AATCC Intersectional Technical Paper Competition from the Piedmont Section entitled, A Method for Measuring the Foam Propensity of Disperse Dyes, *Textile Chemist and Colorist*, Vol. 15, No. 1, January 1983, p21.

Chelating Agents: Active Ingredient Content of Polyaminopolycarboxylic Acids and Their Salts; Copper PAN Method

Developed in 1987 by AATCC Committee RA90; reaffirmed 1988 (with title change), 2002; editorially revised and reaffirmed 1989, 1997; revised 1992.

1. Purpose and Scope

1.1 This test method is an alternate to AATCC Method 149, Chelating Agents: Chelation Value of Aminopolycarboxylic Acids and Their Salts; Calcium Oxalate Method.

1.2 The active ingredient content of ethylenediaminetetraacetic acid (EDTA), N-hydroxyethylethylenediaminetriacetic acid (HEDTA) and diethylenetriaminepentaacetic acid (DTPA) and their salts is usually expressed by the calcium chelation value (CaCV). Titration with a calcium salt using either oxalate or a dye indicator, as done in AATCC Method 149, yields a value which includes partially substituted EDTA, HEDTA, DTPA, nitrilotriacetic acid (NTA), iminodiacetic acid (IDA), glycolate and other weak chelating agents found in some commercial products. This alternative procedure excludes the effect of the partially substituted products, providing a more stringent value.

2. Principle

2.1 Calcium chelation value is determined experimentally by titrating a weighed specimen of chelating agent with a copper nitrate solution of known concentration in the presence of PAN (1-(2-pyridylazo)-2-naphthol). Initially, the color of the solution is yellow-green due to free indicator. When all of the chelating agent has reacted with copper nitrate, the color of the solution changes to a permanent purple which is the end point.

2.2 CaCV indicates the amount of calcium (as calcium carbonate) which will be sequestered by a known weight of chelating agent and is expressed as milligrams of calcium carbonate (CaCO_3) per gram of chelating agent (mg calcium carbonate/g chelating agent).

3. Terminology

3.1 **chelating agent**, *n.*—*in textile chemistry*, a chemical capable of deactivating metal ions by formation of a water soluble complex. SYN: *sequestering agent*.

4. Safety Precautions

NOTE: These safety precautions are for information purposes only. The precautions are ancillary to the testing procedures and are not intended to be all inclusive. It is the user's responsibility to use safe and proper techniques in handling materials in this test method. Manufacturers MUST be consulted for specific details such as material safety data sheets and other manufacturer's recommendations. All OSHA standards and rules must also be consulted and followed.

4.1 Good laboratory practices should be followed. Wear safety glasses in all laboratory areas.

4.2 All chemicals should be handled with care.

4.3 In preparing, dispensing and handling glacial acetic acid and sodium hydroxide use chemical goggles or face shield, impervious gloves and an impervious apron. Concentrated acids and bases should be handled only in an adequately ventilated laboratory hood. CAUTION: Always add acid to water.

4.4 Cupric nitrate 2.5 hydrate is corrosive to the eye and skin and is harmful if inhaled. It is an oxidizing material and may react with organic materials. It should be handled only in an adequately ventilated hood.

4.5 Methanol is harmful if inhaled or swallowed and is a flammable liquid and should be stored in the laboratory only in small containers away from heat, open flames and sparks. This chemical should not be used near an open flame and should be handled only in an adequately ventilated hood.

4.6 An eyewash/safety shower should be located nearby and a self-contained breathing apparatus should be readily available for emergency use.

4.7 Exposure to chemicals used in this procedure must be controlled at or below levels set by governmental authorities (e.g., Occupational Safety and Health Administration's [OSHA] permissible exposure limits [PEL] as found in 29 CFR 1910.1000 of January 1, 1989). In addition, the American Conference of Governmental Industrial Hygienists (ACGIH) Threshold Limit Values (TLVs) comprised of time weighted averages (TLV-TWA), short term exposure limits (TLV-STEL) and ceiling limits (TLV-C) are recommended as a general guide for air contaminant exposure which should be met (see 13.1).

5. Apparatus, Reagents, Materials

- 5.1 Acetic acid, 1.0N (CH_3COOH)
- 5.2 Cupric nitrate 2.5 hydrate ($\text{Cu}(\text{NO}_3)_2 \cdot 2.5\text{H}_2\text{O}$)
- 5.3 Ethylene diaminetetraacetic acid (free acid) (EDTA) ($\text{C}_{10}\text{H}_{16}\text{O}_8\text{N}_2$)
- 5.4 Methanol
- 5.5 1-(2-Pyridylazo)-2-naphthol, (PAN) ($\text{C}_{15}\text{H}_{11}\text{ON}_3$)
- 5.6 Sodium acetate trihydrate ($\text{CH}_3\text{COONa} \cdot 3\text{H}_2\text{O}$)
- 5.7 Sodium hydroxide, 1.0N (NaOH)

6. Conditioning

6.1 If solid chelating agent is being evaluated, dry a 2 g sample at the appropriate temperature for at least 2 h and cool in a desiccator before weighing specimens.

6.2 Dry free acid forms of chelating agents at 120°C.

6.3 Dry salt forms of chelating agents at 80°C.

7. Sampling

7.1 The test should be conducted in triplicate; i.e., three test specimens from a sample should be analyzed.

8. Specimens

8.1 Do not use aluminum or metallic weighing pans.

8.2 For analysis of solid EDTA, HEDTA, and DTPA (either free acid or salt forms) weigh a 0.24-0.26 g specimen of the dried chelating agent to an accuracy of 0.01 g.

8.3 For analysis of commercial solution, of salts of the chelating agents, weigh a 0.49-0.51 g specimen of the solution to an accuracy of 0.01 g.

9. Preparation of Reagents

9.1 Cupric Nitrate Solution: Dissolve 23.30 g of cupric nitrate 2.5 hydrate and dilute to 1.000 L in a volumetric flask. Calculate the molarity of the cupric nitrate solution (see 11.1).

9.2 PAN Indicator: Dissolve a 0.025 g of 1-(2-pyridylazo)-2-naphthol in 50 mL of methanol. Store in a refrigerator in a stoppered bottled. Prepare fresh weekly.

9.3 Acetate Buffer Solution: (pH = 4.65). Dissolve 34.0 g of sodium acetate

trihydrate in 500 mL of water and add 15 mL of glacial acetic acid. Mix well and store in a closed container.

9.4 Standardization of Copper-Nitrate Solution: Weigh to the nearest 0.0001 g approximately 0.5 g quantity of pure reagent grade EDTA acid powder into each of the three 250 mL Erlenmeyer flasks. Add 150 mL of distilled water and 6.5 mL of 1.0*N* sodium hydroxide (or five drops of 50% sodium hydroxide) and stir the mixture until the EDTA is dissolved. Add 25 mL of sodium acetate buffer. Adjust to pH 4.5-5.5 with 1.0*N* acetic acid or 1.0*N* sodium hydroxide, if necessary. Add 1 mL PAN indicator and titrate immediately with copper nitrate to a permanent purple end point. Calculate the molarity of copper as follows:

$$M = \frac{(W)(P)(K)}{V}$$

where:

- M* = Molarity of copper nitrate, expressed in moles/L
- W* = Weight of EDTA acid in grams
- P* = Percent purity of EDTA acid
- V* = Volume of copper nitrate titrant in mL

$$\begin{aligned} K &= 0.042994 \\ &= \frac{(1000) \text{ mL/L}}{(100)(232.59 \text{ g/mole})} \\ &= 0.042994 \frac{\text{mole} \cdot \text{mL}}{\text{g} \cdot \text{L}} \end{aligned}$$

10. Procedure

10.1 Quantitatively transfer the specimen to a 500 mL Erlenmeyer flask and add 150 mL of water (see 8.1, 8.2 and 8.3). Wash any residual chelating agent from the weighing paper or dish into the flask, and swirl to mix (dissolve).

10.2 Add 25 mL of pH 4.65 acetate buffer solution to the flask and swirl to mix. Check the pH and adjust to 4.5-5.5 with 1.0*N* acetic acid or 1.0*N* sodium hydroxide, if necessary.

10.3 Add 1 mL of PAN indicator to the flask and swirl to mix.

10.4 Titrate with 0.1000 M cupric nitrate solution to a purple end point that persists for at least 1 min.

11. Calculation

11.1 Calculate the calcium chelation value (CaCV) to 3 significant digits for each titration using the following equation:

$$\text{CaCV} = \frac{(100.1)(V)(M)}{W}$$

where:

- CaCV = Calcium chelation value, expressed as mg CaCO₃/g chelating agent
- V* = Volume of cupric nitrate titrant in mL
- M* = Molarity of cupric nitrate solution, expressed in mmoles/mL
- 100.1 = Molecular weight of calcium carbonate, expressed in mg/mole

12. Precision and Bias

12.1 *Precision*. The intralaboratory, single operator, single apparatus, same day precision of the test method is ± 2 (1.60) standard deviations. The interlaboratory precision of the test method (over five participating laboratories) is ± 1 (0.54) standard deviations.

12.2 *Bias*. The bias of this test method is being established.

13. Notes

13.1 Available from Publications Office, ACGIH, Kemper Woods Center, 1330 Kemper Meadow Dr., Cincinnati OH 45240; tel: 513/742-2020.

Weather Resistance of Textiles: Xenon Lamp Exposure

Developed in 1987 by Committee RA64; reaffirmed 1988, 1989; revised 1990, 2003; editorially revised and reaffirmed 1995.

1. Purpose and Scope

1.1 This test method provides a procedure for the exposure of textile materials of all kinds, including coated fabrics and products made thereof, in an artificial weathering apparatus using controlled conditions of test. This test method includes procedures for both controlled wetting and no wetting of the specimen.

1.2 Resistance to degradation is measured either as percent strength loss or percent residual strength (breaking, tearing, or bursting) and/or colorfastness of the material when evaluated under standard textile testing conditions.

2. Principle

2.1 Samples of the textile material to be tested and the agreed upon comparison standard are exposed simultaneously to a xenon lamp source under specified conditions. Resistance of the test material to degradation is compared to that of a comparison standard.

3. Terminology

3.1 **breaking strength**, n.—the maximum force applied to a specimen in a tensile test carried to rupture.

3.2 **bursting strength**, n.—the force or pressure required to rupture a textile by distending it with a force, applied at right angles to the plane of the fabric, under specified conditions.

3.3 **colorfastness**, n.—the resistance of a material to change in any of its color characteristics, to transfer of its colorant(s) to adjacent materials, or both, as the result of exposure of the material to any environment that might be encountered during processing, storage, use or testing of the material.

3.4 **irradiance**, n.—radiant power per unit area as a function of wavelength expressed as watts per square meter, W/m^2 .

3.5 **irradiation**, n.—the time integral of irradiance expressed in joules per square meter (J/m^2).

3.6 **radiant energy**, n.—energy traveling through space in the form of photons or electromagnetic waves of various lengths.

3.7 **radiant flux density**, n.—rate of flow of the radiant energy past the specimen.

3.8 **radiant power**, n.—energy per unit time emitted, transferred, or received as radiation.

3.9 **spectral energy distribution**, n.—the variation of energy due to the source over the wavelength span of the emitted radiation.

3.10 **spectral transmittance**, n.—the percent of incident radiant energy passing through a given material and not absorbed in the process, as a function of wavelength.

3.11 **standard atmosphere for testing textiles**, n.—air maintained at $21 \pm 1^\circ C$ ($70 \pm 2^\circ F$) and $65 \pm 2\%$ relative humidity.

3.12 **tearing strength**, n.—the average force required to continue a tear previously started in a fabric.

3.13 **total irradiance**, n.—radiant power integrated over all wavelengths at a point in time expressed in watts per square meter (W/m^2).

3.14 **weather**, n.—climatic conditions at a given geographical location, including such factors as sunlight, rain, humidity, and temperature.

3.15 **weather resistance**, n.—ability of a material to resist degradation of its properties when exposed to climatic conditions.

4. Safety Precautions

NOTE: These safety precautions are for information purposes only. The precautions are ancillary to the testing procedures and are not intended to be all inclusive. It is the user's responsibility to use safe and proper techniques in handling materials in this test method. Manufacturers MUST be consulted for specific details such as safety data sheets and other manufacturer's recommendations. All OSHA standards and rules must also be consulted and followed.

4.1 Do not operate the test equipment until the manufacturer's operating instructions have been read and understood. It is the responsibility of whoever operates the test equipment to conform to the manufacturer's directions for safe operation.

4.2 The test equipment contains high intensity lamps. The door of the test machine must be kept closed whenever it is running.

4.3 Before servicing xenon lamps, allow time for cool down after test machine is shut down.

4.4 When servicing the test machine, shut off both the off switch and, if applicable, unplug the machine from the wall

electrical socket. Insure that the main power indicator light on the machine front panel goes out.

5. Uses and Limitations

5.1 Results obtained by this test method should not be considered equivalent to those results obtained by weathering in an outdoor environment unless a mathematical correlation for a given material has been established and agreed upon by the contractual parties. Outdoor environments vary with respect to season, geography and topography and, as a consequence, the effects of outdoor exposure will vary accordingly. Not all materials are affected equally by the same environment. The instruments for determining weather resistance described in this test method are considered satisfactory, since they have been used extensively in the trade for acceptance testing of textile materials. The decision as to which machine type to use should be agreed upon by the purchaser and supplier based on their historical data and experience. There may be distinct difference in spectral distribution, water spray application, air and humidity sensor location, and test chamber size between weathering test machines supplied by different manufacturers that can result in differences in reported test results (see 16.1-16.8). Consequently, data obtained from machines supplied by different manufacturers and different size test chambers and xenon lamps cannot be used interchangeably unless a mathematical correlation has been established and agreed upon. No comparison between differently manufactured test apparatus is known to AATCC Committee RA64.

5.2 When using this test method, the contracting parties must agree upon a reasonable test program cycle incorporating light, humidity, and wetting effects. The cycle selected must reflect expected environmental conditions relative to season, geography, and topography associated with the use of the material (see Option 1, 7.2.1).

5.3 When using this test method, use a standard of comparison, which has a known change in property value after a specific exposure.

5.4 Other procedures for measuring resistance to degradation can be used as agreed upon between the contracting parties.

6. Apparatus

6.1 Different types of xenon-arc test apparatus may be utilized provided that the test apparatus is constructed of corrosion resistant material and shall provide for means of automatically controlling irradiance level, humidity level, chamber air temperature, and Black Panel or Black Standard Thermometer temperature.

6.2 Xenon-Arc Light Source. The xenon-arc test apparatus utilizes a long-arc quartz-jacketed xenon-arc lamp as the source of irradiance, which emits radiation from below 270 nm in the ultraviolet through the visible spectrum and into the infrared. While all of the xenon-arc lamps are of the same general type, different size lamps operated in different wattage ranges are employed in several sizes and types of apparatus. In each of the various models, the specimen rack varies according to the lamp size and the wattage at which it is operated to provide an irradiance at the face of the specimen of 0.35 W/m^2 measured at 340 nm or equivalent when exposed in standard holders. Operate the xenon-arc test apparatus in accordance to one of the selected test cycle Options 1-4 (see 7.2.1-7.2.4).

6.2.1 Filter—In order for xenon-arcs to simulate terrestrial daylight, filters must be used to remove short wavelength UV radiation. In addition, filters to remove infrared radiation may be used to prevent unrealistic heating of test specimens that can cause thermal degradation not experienced during outdoor exposures.

Xenon-Arc test apparatus shall be equipped with a Daylight Filter to provide the appropriate spectrum. The Daylight Filter shall comply with the relative spectral power distribution requirements specified in Appendix A.

6.2.2 Follow the xenon-arc test apparatus manufacturer's instructions for recommended maintenance. Refer to Notes section for specific test apparatus descriptions and suppliers. Unless otherwise specified, control the level of irradiance to $0.35 \pm 0.01 \text{ W/m}^2/\text{nm}$ bandpass at 340 nm, or $40 \pm 1.5 \text{ W/m}^2$ bandpass at 300-400 nm unless otherwise specified. Operate the xenon-arc test apparatus in accordance to one of the selected test cycle Options 1-4 (see 7.2.1-7.2.4).

7. Test Cycle Determination

7.1 The test cycle is determined by the influencing factors of the end-use, in particular, the climatic conditions. Not all materials are affected equally by the same environment. Results obtained by the use of any one test cycle may not be representative of those of any other test cycle or any outdoor weathering test. Acceleration factors derived for one

geographic location do not necessarily apply to any other geographic location. However, certain test cycles have been used to group similar climates with respect to the test cycle.

7.2 The nature of the test material contributes to the selection of the appropriate test cycle with respect to UV exposure, wetting, wet time and temperature. The apparatus may be equipped to monitor specific portions of a continuous spectrum, control the level of irradiance to $0.35 \pm 0.01 \text{ W/m}^2/\text{nm}$ bandpass at 340 nm, or $40 \pm 1.5 \text{ W/m}^2$ bandpass at 300-400 nm unless otherwise specified. The following test cycle options have been used for textile materials.

7.2.1 Option 1—This cycle has been used to approximate a semi-tropical climate such as found in South Florida: 120 min cycle, 90 min light only, $70 \pm 5\%$ RH, alternating with 30 min light and water spray, black panel temperature $77 \pm 3^\circ\text{C}$ ($170 \pm 5^\circ\text{F}$).

7.2.2 Option 2—This cycle has been used to approximate a semi-tropical climate such as found in South Florida when appropriate machine water supply is restricted: 120 min cycle, 60 min light only, $70 \pm 5\%$ RH, alternating with 60 min dark, black panel temperature $77 \pm 3^\circ\text{C}$ ($170 \pm 5^\circ\text{F}$), no water spray.

7.2.3 Option 3—This cycle has been used to approximate a semi-arid climate such as found in Phoenix, Arizona: Light on cycle, continuous light only, no water spray, black panel temperature $77 \pm 3^\circ\text{C}$ ($170 \pm 5^\circ\text{F}$), $27 \pm 3\%$ RH.

7.2.4 Option 4—This cycle has been used to approximate a temperate climate such as found in Columbus, Ohio: 120 min cycle, 102 min light only, $50 \pm 5\%$ RH, alternating with 18 min of light and water spray, black panel temperature $63 \pm 3^\circ\text{C}$ ($145 \pm 5^\circ\text{F}$).

7.3 The use of these cycles does not imply, expressly or otherwise, an accelerated weathering test. This test method is not restricted to the use of these cycles.

8. Standards for Comparison

8.1 Standards for comparison must be determined and agreed upon by the contractual parties. The standards can be any suitable textile material where a history of the rates of strength degradation or color change is known. Standards must be exposed simultaneously with the test specimen. The standard used with water spray options must not show any character change as a result of the water spray. The use of the standard is to determine time-to-time equipment and test procedure variations. If test results of the exposed standards differ by more than 10% from the known standard data, thoroughly review the test machine operating conditions, and correct any malfunctions or defective parts. Then, repeat the test. If the data still differ by more than 10% from the known data and there is no evidence of machine malfunction, then the standard should be questioned and re-evaluated.

8.2 When colorfastness is the sole evaluation criterion, Blue Wool Standards, as defined in AATCC Method 16, Colorfastness to Light, are acceptable for options using no water spray. However, use caution since the rate of any fade of the Blue Wool Standards by any one test method may not agree with that of other test methods.

8.3 Visual Comparison—equals the Step 4 color change of the Gray Scale for Color Change, or equals the L4 Standard of Fade applicable to the Lot designation used.

8.4 Instrumental Color Measurement—for Lot 5, AATCC Blue Wool Lightfastness Standard L4, equals 1.7 ± 0.3 CIELAB units of color change as determined by AATCC Evaluation Procedure 6, Instrumental Color Measurement. Other Lot designations of AATCC Blue Wool Lightfastness Standard L4 equals the CIELAB units of color change specified on the calibration certificate supplied with the standard as determined by AATCC Evaluation Procedure 6.

Table I—AATCC Fading Unit and Light Exposure Equivalents for AATCC Blue Wool Lightfastness Standards

AATCC Blue Wool Lightfastness Standard	AATCC Fading Units	Xenon Only $\text{kJ/m}^2/\text{nm}$ @ 420 nm	Xenon Only kJ/m^2 300-400 nm
L2	5	21	864
L3	10	43	1728
L4 ^a	20	85 ^b	3456
L5	40	170	6912
L6	80	340 ^b	13824
L7	160	680	27648
L8	320	1360	55296
L9	640	2720	110592

^a For color change of 1.7 ± 0.3 CIELAB units or Step 4 on the AATCC Gray Scale for Color Change.

^b Verified by experiment using Daylight Behind Glass and Xenon-Arc, Continuous Light. All other values are calculated (see Note 32.18 in AATCC TM 16).

9. Test Specimens

9.1 Number of Specimens—Use replicate specimens (see 16.9) of both the material to be tested and the standard for comparison as required to ensure accuracy.

9.2 Fabric Specimen Size, Initial—These dimensions are given as a general guide and in most cases will be adequate to perform the required evaluation. Certain materials may undergo dimensional change during exposure. The test equipment manufacturer, physical test apparatus, and number of replicate specimens required will affect the needed sample size. Review the test procedures given in 13.3 to ensure that a sufficient number of specimens are exposed for the individual tests of degradation (see 16.10). Minimize the effect of fabric variation by randomly selecting pairs of test specimens from a fabric sample. One specimen from each pair is used for the exposure, the second, is used for the control (unexposed) test. Each pair of specimens shall contain the same warp yarns for warpwise tests and the same fill yarns for fillingwise tests. No two pairs of test specimens cut parallel to the warp should contain the same set of warp ends, and no two pairs of test specimens cut parallel to the filling should contain the same set of filling picks. Cut samples for the specified test procedures as follows:

9.2.1 Breaking Strength—When strip breaking strength is required, cut strips of fabric at least 5×20 cm (2×8 in.) with the longer dimension parallel to the warp or machine direction unless otherwise specified. When grab breaking strength is specified, cut swatches of fabric at least 13×18 cm (5×7 in.) (see 16.11).

9.2.2 Bursting Strength—Cut swatches of fabric at least 15×15 cm (6×6 in.).

9.2.3 Tongue Tear Strength—Cut swatches of fabric at least 10×23 cm (4×9 in.) with the shorter direction parallel to the warp or machine direction unless otherwise specified (see 16.11 and 16.12).

9.2.4 Elmendorf Tear Strength—Cut swatches of fabric at least 10×13 cm (4×5 in.) with the longer dimension parallel to the warp or machine direction unless otherwise specified (see 16.11 and 16.12).

9.2.5 Trapezoid Tear Strength—Cut swatches of fabric at least 10×18 cm (4×7 in.) with the longer dimension parallel to the warp or machine direction unless otherwise specified (see 16.11 and 16.12).

9.2.6 Colorfastness—Cut swatches of fabric at least 3×6 cm (1.2×2.4 in.) with the exposed area measuring not less than 3×3 cm (1.2×1.2 in.) adjacent to an unexposed area having the same dimension.

9.2.7 When required to prevent raveling, the samples may be edged using a

flexible epoxy or similar resin.

9.2.8 Identify each sample using a label resistant to the environment encountered during the test.

9.3 Mounting.

9.3.1 Mount the samples on open-back frames, which are installed in the cabinet without backing unless otherwise specified (see 16.13).

9.3.2 Fabrics—Secure the samples to the frames to hold them smooth without curling of the edges. Fabrics may be stitched to a gauze backing.

9.3.3 Yarns—Wind or fasten yarns on frames to a length of 15 cm (6 in.) minimum. Only that portion of the yarns directly facing the radiant energy is tested for breaking (tensile) strength. Either single strand or multiple strand tests may be used. In multiple strand tests, wind the yarns on the frame closely packed to 2.54 cm (1.0 in.) width. The control sample must contain the same number of strands as the sample subjected to exposure. After the exposure has been completed and before the yarns are unwound for testing, bind together those yarns facing the light source using 2 cm (0.75 in.) masking or other suitable tape to keep the yarns closely packed on the exposure frame.

10. Conditioning

10.1 Condition samples after exposure by bringing all specimens, control and test, to moisture equilibrium in the atmosphere for testing textiles as directed in ASTM Practice D 1776, Standard Practice for Conditioning and Testing Textiles. Equilibrium is considered to have been reached when the increase in mass of the sample in successive weighings made at intervals of not less than 2 h does not exceed 0.1% of the mass of the sample. Generally, the industry approaches equilibrium from the "As Received" side.

10.2 It is recognized that in practice textile materials are frequently not weighed to determine when moisture equilibrium has been reached. While such a procedure cannot be accepted in cases of dispute, it may be sufficient in routine testing to expose the material to the standard atmosphere for testing for a reasonable period of time before the specimens are tested. Twenty-four hours has been found acceptable in most cases; however, certain fibers or treatments may exhibit slow moisture equalization rates from the "As Received" side. When this is known, a preconditioning cycle, as described in ASTM D 1776 may be agreed upon between contractual parties.

11. Preparation, Maintenance and Calibration of Test Apparatus

11.1 Install the test apparatus in a room where temperature and relative humidity are controlled to minimize the effects of

air supply variations.

11.2 Be sure that the test apparatus is calibrated at the start of each test within the limits specified by the manufacturer. The instruments associated with the exposure apparatus (that is, light monitor control system, Black Thermometers, chamber air sensor, humidity control system, UV sensors and radiometers) require periodic calibration. Whenever possible, calibration should be traceable to national or international standards. Calibration schedule and procedure should be in accordance with manufacturer's instructions.

11.3 Aging of the xenon burners or filters can result in changes in lamp spectrum. Changes in lamp spectrum may also be caused by accumulation of dirt or other residue in or on the burner envelope.

11.4 Replace filters when chipped, cracked, or when discoloration or milkiness develops. Discard xenon lamp tubes and filters at the manufacturer's recommended time intervals.

11.5 The black panel sensor unit indicates the absorbed irradiance minus the heat dissipated by conduction and convection. Keep the face of the black panel in good condition. Although it is coated with a high quality finish, when exposed in the weathering apparatus it is subject to deterioration. Therefore, periodically clean and polish it with a high grade automobile wax. Maintain a control black panel unit to periodically check the operating black panel unit for conformance. When an operating black panel unit falls outside the limits established for the test procedure, compared to the control unit, refinish or replace the unit.

11.6 For test programs with water spray, use deionized, demineralized or distilled water that contains less than 17 ppm of total solids and preferably water of 6-8 ppm to reduce deposits on the test specimen. Use water having a pH maintained at 7 ± 1 . Use stainless steel or other acceptable water transport lines that will not contaminate the water. Maintain water temperature entering the test chamber at $16 \pm 5^\circ\text{C}$ ($60 \pm 9^\circ\text{F}$).

11.7 Be sure the wattage and water supply during the test is as specified in the detailed description of the apparatus furnished by the manufacturer. Be sure the designated black panel temperature and relative humidity are provided.

11.8 Control the test environment as specified by the chosen test option.

11.9 Program or adjust the instrument to provide a continuous light test. Fill the specimen area with framed material and the black panel thermometer. The material is used to simulate air flow in the test chamber during the test exposure and should not include the actual test samples. Support the black panel thermometer in the specimen drum or rack in the

same manner as the material. Operate and control the test apparatus as defined by the manufacturer. Operate the test apparatus in this mode and adjust the chamber temperatures, and humidity controls to provide the required black panel temperature and relative humidity.

11.10 Shut down the test apparatus after operating at the controlled conditions for 60 min. Remove the material from the specimen rack.

12. Procedure

12.1 Program the xenon-arc test apparatus to run test conditions specified in 7.2.

12.2 Mount the framed test specimens on the specimen rack as recommended by the test apparatus manufacturer. Make sure that all materials are adequately supported and in proper vertical alignment. Any displacement of the material toward or away from the source, even by a small distance, may lead to variation in degradation between specimens. The specimen rack must be filled; extra material is used when the number of specimens being tested is insufficient to fill the specimen rack.

12.2.1 For single strand tests when material length exceeds 23 cm (9 in.) center the test specimens in the exposure area.

12.3 In the case of woven, knitted, and nonwoven fabrics, ensure that the side directly exposed to the radiant source is that normally used as the face. If for any reason, the face of the material is not exposed, report it with the data.

12.4 For test program cycles with water spray, ensure that the water spray strikes the test samples as a fine spray equally distributed over the surface exposed to the radiation.

12.5 Monitor exposure test chamber conditions with suitable recorders (optional).

12.6 Operate the test apparatus continually until the selected exposure has been completed. Avoid unnecessary delays when filters or lamps are changed and the exposure period continued, as such delays may contribute to variations in results or lead to errors.

12.7 To ensure uniform total irradiation over the specimen surface, reposition specimens in a sequence, which will provide each specimen equivalent exposure periods in each location. When the exposure interval does not exceed 24 h, locate each sample equidistant from the horizontal axis of the xenon lamp arc. Rotate the test samples after each 250 h of exposure. Other test methods of achieving uniform total irradiation may be employed if mutually agreed upon by the contractual parties.

12.8 Replace filters according to manufacturer's instructions, or when pro-

nounced discoloration or milkiness develops, whichever occurs first.

12.9 Operate the test apparatus on a time cycle of at least a seven day exposure.

12.10 When the exposure cycle is completed, remove the replicate standard and test specimens from the exposure rack. Transfer them to a standard atmosphere for testing textiles for conditioning to perform agreed upon physical tests.

12.10.1 If upon removal from the racks, the specimens are wet, dry them without tension at ambient laboratory conditions or at a temperature not exceeding 71°C (160°F) before transferring them to the conditioning atmosphere. Wet-out the unexposed reference standard (comparison standard) and the retained unexposed original. Treat them under the same conditions of drying and conditioning as the exposed test specimens before physical testing or colorfastness evaluation.

13. Evaluation

13.1 Rate either the durability or resistance to degradation of the material with respect to the standard of comparison by one or more of the following:

13.1.1 Percent strength retained or percent strength loss—Record percent strength loss or percent strength retained (breaking, tearing, or bursting as appropriate) of the material after the prescribed exposure time period.

13.1.2 Residual Strength—Record the initial and final strength values along with all other pertinent data.

13.1.3 In Terms of the Agreed Upon Comparison Sample or Standard:

a) Satisfactory—As durable or more durable than the comparison standard at the amount of exposure time period prescribed in the material standard.

b) Unsatisfactory—Less durable than the comparison sample at the amount of exposure time period prescribed in the material standard.

13.2 Test specimen preparation after exposure is preferred but may be done before exposure (see 16.7). For each test to be made on the material and control, exposed and unexposed, prepare test specimens by marking and raveling or cutting the central portion of each exposed sample to the dimensions specified in the respective test procedures (see 13.3.)

13.3 Physical Properties. Determine the change in properties of fabrics as directed in one or more of the following test methods:

13.3.1 Determine the breaking strength of fabrics as directed in ASTM Test Method D 5035, Breaking Force and Elongation of Textile Fabrics (Strip Test), using the appropriate procedure as specified.

13.3.2 Determine the breaking strength of yarns as directed in ASTM Test Method D 2256, Breaking Load (Strength) and Elongation of Yarn by the Single-Strand Method.

13.3.3 Determine the ball bursting strength of fabrics as directed in ASTM Test Method D 3787, Bursting Strength of Knitted Goods-Constant-Rate-of Traverse (CRT) Ball Burst Test.

13.3.4 Determine the diaphragm bursting strength of fabrics as directed in ASTM Test Method D 3786, Hydraulic Bursting Strength of Knitted Goods and Nonwoven Fabrics-Diaphragm Bursting Strength Tester Method. Use the Model C type tester for fabrics having a bursting strength of 200 psig or less; and the Model A type tester for fabrics having a bursting strength greater than 200 psig.

13.3.5 Determine the Tongue tear strength as directed in ASTM Test Method D 2261, Tearing Strength of Fabrics by the Tongue (Single Rip) Procedure (Constant-Rate-Of-Extension Tensile Testing Machine)

13.3.6 Determine the Elmendorf tear strength as directed in ASTM Test Method D 1424, Tearing Strength of Fabrics by Falling Pendulum Type (Elmendorf) Apparatus.

13.3.7 Determine the trapezoid tear strength as directed in ASTM Test Method D 5587, Test Method for Tearing Strength of Fabrics by Trapezoid Procedure.

13.3.8 Measure the color change of AATCC lightfastness standards as directed in AATCC Evaluation Procedure 6, Instrumental Color Measurement.

13.3.9 Average the data for the various replicates, or handle statistically as appropriate, and record a significant value of breaking, tearing, or bursting strength retention and/or colorfastness after exposure in relation to original strength or color, as applicable. It is appropriate to record the percent elongation characteristics of the unexposed controls and exposed specimens at rupture or at some prescribed point in the force-elongation curve as this is often times significant supplementary information (see 16.15).

14. Report

14.1 Include in the report the type of test apparatus, including model, serial number, and manufacturer's name, exposure program, elapsed exposure time, sample rotation schedule, irradiance level, black panel temperature, chamber air temperature, relative humidity, if black panel temperature was controlled by ambient (chamber air) or black panel and type of water supply.

14.2 Report the type of equipment used in measuring the strength characteristics of the fabric, the type of fiber(s) of which

the material is composed, which side of the fabric was exposed (in the event that the fibers differ on the face and back of the fabric), the fabric weight in g/m² (oz/yd²) and the nature of the fabric finish, if known.

14.3 Report any deviation from this method or the performance of the standard of comparison.

14.4 Report the rating and relative data for each property evaluated.

14.5 Report the operating schedule of the test apparatus.

15. Precision and Bias

15.1 Precision.

15.1.1 CIE Delta E Color Change Testing. Four samples of coated fabrics (Geo Textile Samples), 5 replicates of each, were tested according to AATCC TM 169-1991 in a Ci₆₅ Weather-Ometer. The test cycle consisted of 90 min of light only followed by 30 min of light and spray. Black Panel temperature 70 ± 3°C, relative humidity 55 ± 5%, specimen rotation—none.

15.1.2 Tensile Testing. Tensile tests were made on samples before and after exposure intervals of 409.5, 819 and 1228 kJ/m² @ 340 nm (325, 650 and 975 h) Test Method: ASTM D 1682, Two-inch Cut Strip Test.

Test Device: Instron Model 1000
Weight Beam Capacity: 1,000 lbs

Full Scale Load: 100, 200, 500, 1000 lbs
Cross head Speed: 12 in. per min

Gage Length: 3 in. Number of specimens per direction per sample: 5

Test Direction: machine

15.2 Bias. There is no referee method for determining the true value of weather resistance of textile materials. The bias of a xenon lamp exposure for acceptance testing cannot be determined; therefore, this method has no known bias.

16. Notes

16.1 Test apparatus are available from SDL Atlas L.L.C., 1813A Associate Lane, Charlotte NC 28217; tel: 704/329-0911; fax: 704/329-0914; e-mail: sdatlas.com; and Suga Test Instruments Co. Ltd., 5-4-14, Shinjuku, Shinjuku-ku, Tokyo, 160-0022, Japan; tel: +81 3 3354/5241; fax: +81 3 3354/5275.

16.2 Water-Cooled test apparatus. A water-cooled system, available in three test chamber sizes and various wattage capacities, and found suitable for use with this test method, is described in 16.3-16.5 below.

16.3 Test chamber type 1A, a xenon lamp type artificial weathering apparatus, consists of a water-cooled xenon lamp (long arc) radiant energy source positioned at the central axis of a 96 cm (37.75 in.) diameter vertical specimen rack.

16.4 Test chamber type 1B, a xenon lamp

Table II—CIE Delta E Color Change Testing
CIE Delta E*

sample ID	409.5kJ		819kJ		1638 kJ	
2-1	4.02		8.15		20.83	
2-2	2.40		9.18		20.43	
2-3	3.26		8.49		18.75	
2-4	3.42		5.08		18.23	
2-5	1.72		5.69		17.72	
Avg 2	2.96	0.91	7.32	1.82	19.19	1.37
3-1	9.62		6.51		7.80	
3-2	9.26		6.04		6.79	
3-3	9.65		6.55		6.88	
3-4	9.61		6.68		6.85	
3-5	9.47		6.54		7.41	
Avg 3	9.52	0.16	6.46	0.25	7.15	0.44
4-1	1.14		0.60		1.07	
4-2	1.39		0.52		0.95	
4-3	1.23		0.62		0.97	
4-4	1.41		0.64		0.92	
4-5	1.52		1.05		0.88	
Avg 4	1.34	0.15	0.69	0.21	0.96	0.07
5-1	6.65		11.50		25.34	
5-2	6.64		11.86		26.56	
5-3	6.55		12.80		26.30	
5-4	6.64		12.23		26.23	
5-5	7.32		13.13		27.09	
Avg 5	6.76	0.32	12.30	0.67	26.30	0.64

Table III—Tensile Strength Testing

Sample No.	409.5 kJ/m ² Breaking Load, lbs						Average	Std Dev	% Strength Loss
	Individual Values								
2	620	588	550	650	643	610	41.45		
	396	424	398	428	426	414	15.96	32.1%	
3	459	515	508	430	425	467	42.37		
	498	430	435	473	487	465	30.66	0.6%	
4	229	221	220	213	222	221	5.70		
	162	169	152	154	156	159	6.91	28.2%	
5	728	823	832	842	871	819	54.08		
	527	571	562	563	584	561	21.15	31.5%	
Sample No.	819 kJ/m ² Breaking Load, lbs						Average	Std Dev	% Strength Loss
	Individual Values								
2	620	588	550	650	643	610	41.45		
	324	328	330	297	322	320	13.35	47.5%	
3	459	515	508	430	425	467	42.37		
	333	349	338	344	322	337	10.43	27.9%	
4	229	221	220	213	222	221	5.70		
	105	98	101	96	98	100	3.51	54.9%	
5	728	823	832	842	871	819	54.08		
	432	447	391	443	427	428	22.20	47.8%	
Sample No.	1228 kJ/m ² Breaking Load, lbs						Average	Std Dev	% Strength Loss
	Individual Values								
2	620	588	550	650	643	610	41.45		
	214	211	216	221	207	214	5.26	65.0%	
3	459	515	508	430	425	467	42.37		
	174	180	175	174	171	175	3.27	62.6%	
4	229	221	220	213	222	221	5.70		
	55	49	56	52	49	52	3.27	76.4%	
5	728	823	832	842	871	819	54.08		
	200	201	212	206	209	206	5.13	74.9%	

type artificial weathering apparatus, consists of a water-cooled xenon lamp (long arc) radiant energy source positioned at the central axis of a 64.8 ± 0.3 cm (25.5 ± 0.125 in.) diameter inclined specimen rack.

16.5 Test chamber type 1C, a xenon lamp type artificial weathering apparatus, consists of a water-cooled xenon lamp (long arc) radiant energy source positioned at the central axis of a 51 ± 0.3 cm (20 ± 0.125 in.) diameter, vertical specimen rack.

16.6 Air-Cooled test apparatus. An air-cooled system, available in two test chamber sizes and various wattage capacities, also used and found suitable for use with this test method, is described in 16.7-16.8 below.

16.7 Test chamber type 2A, a xenon lamp type artificial weathering apparatus, consists of three air-cooled xenon lamps (long arc) as a radiant energy source positioned within a 61 ± 0.3 cm (24.1 ± 0.125 in.) diameter vertical specimen rack to provide a specified spectral energy distribution.

16.8 Test chamber type 2B, a xenon lamp type artificial weathering apparatus, consists of an air-cooled xenon lamp (long arc) as a radiant energy source positioned at the central axis of a 15.7 ± 0.3 cm (6.2 ± 0.125 in.) diameter vertical specimen rack to simulate a specified spectral energy distribution.

16.9 Unless otherwise agreed upon, as when specified in an applicable material specification, use a number of specimens such that the expected test result is not more than 5.0% of the average above or below the true average of the lot at the 95% probability level. Determine the number of specimens using coefficient of variation with one-side limits as directed in ASTM Practice D 2905, Number of Specimens Required to Determine the Average Quality of Textiles.

16.10 The material specification may fur-

ther define the use of wet breaking, tearing, or bursting strength tests in lieu of or to complement those tests done under standard textile testing conditions. Report conditions of test along with the data.

16.11 In general, the warp direction is used, but the filling direction may be used to complement or in place of the warp direction when specified. Warp yarns sometimes are protected from the irradiance due to fabric structure. When the filling is used, it must be reported.

16.12 Under certain conditions, by agreement between principals to a transaction, tearing strength of the material can be used in lieu of, or to complement, the breaking or bursting strength.

16.13 Make sample frames of stainless steel or suitably coated steel to avoid contaminating the specimens with metallic impurities that might catalyze or inhibit the degradation. When samples are fastened with staples, they should be of the nonferrous type over-coated to avoid contamination of the specimen by corrosion products. Metal frames must have a dull finish and be designed to avoid reflectance that could influence the performance of the material. Frames should conform to the curvature of the specimen rack. The size of the frame is determined by the type specimens required for individual property requirements.

16.14 When preparing specimens from the exposed material, consideration must be given to the usable part of the sample and the type test apparatus employed.

16.15 In the case of some fabric blends, the cellulosic component may be seriously damaged, but the high strength of the synthetic component may mask any significant strength loss. In those cases it may be advisable to evaluate the degradation effects by the weight loss procedure in test methods such as: ASTM D 3884, Abrasion resistance of Textile Fabrics

(Rotary Platform, Double-Head Method), or ASTM D 3512, Pilling Resistance and Other Related Surface Changes of Textile Fabrics: Random Tumble Tester Method.

APPENDIX A Xenon-Arc Light Spectrum

A1 Xenon-Arc test apparatus shall be equipped with a Daylight Filter to provide the appropriate spectrum. The Daylight Filter shall comply with the relative spectral power distribution requirements specified in Table A1 and in Fig. A1.

Table A1—Relative Spectral Power Distribution Specification for Xenon-Arc with Daylight Filter

Wave-length bandpass (nm)	Relative irradiance in percent (%) ¹⁾		CIE No. 85, Table 4
	minimum	maximum	
< 290		0.14	
290-320	1.0	7.8	5.4
320-360	27.6	42.8	38.2
360-400	47.3	71.7	56.4

¹⁾ expressed as a percentage of the total irradiance < 400 nm.

The UV irradiance (290-400 nm) is 11% and the VIS irradiance (400-800 nm) is 89% expressed as a percentage of the total irradiance from 290-800 nm (CIE No.85, Table 4). These values measured on specimen plane in instruments may vary when performing a test due to the reflectance properties and number of specimens.

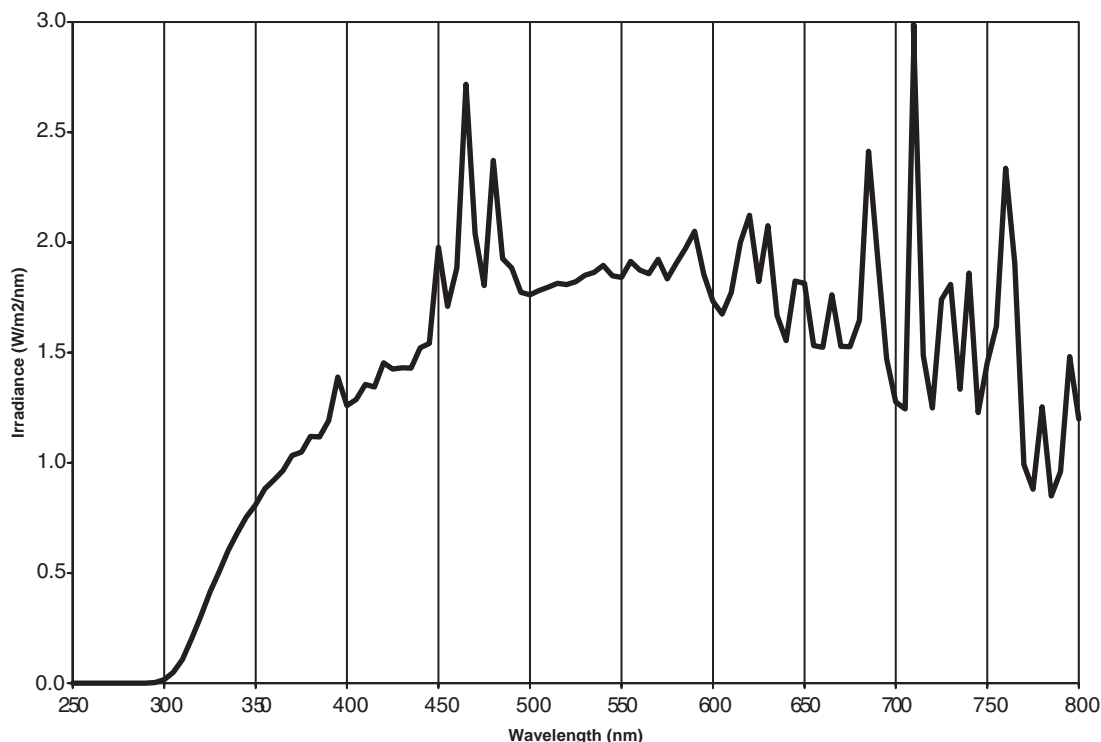

Fig. A1—Xenon Arc Spectral Power Distribution with Daylight Filters

Dusting Propensity of Powder Dyes: Evaluation of

Developed in 1987 by Committee RA87; editorially revised and reaffirmed 1988, 1989 (title change), 1996; editorially revised 1992, 2004; reaffirmed 2001.

1. Purpose and Scope

1.1 This test method provides a standard method for the evaluation of dusting properties of powder dyes.

1.2 The method of assessment permits the assignment of a numerical rating describing the degree of dusting; or, conversely, the degree of non-dusting of powder dyes.

1.3 This test method is not intended for a quantitative determination of dusting. Water soluble dyes may give an inferior rating than an equal amount of dusting caused by disperse dyes. Further studies indicated that not all factors; i.e., humidity, are fully controlled. Also the method does not distinguish between slow and fast settling dust.

2. Principle

2.1 Three, approximately equal, weighed portions of a 10 g powder dye sample are dropped consecutively and rapidly into a funnel which has a wet filter paper collar on the stem and is fitted into a cylinder. Any dust which forms rises and settles on the pre-wet filter paper collar.

2.2 The resulting coloration on the filter paper is then compared to a series of five standards and a numerical rating is assigned.

3. Terminology

3.1 **dusting**, n.—the tendency of particles of sufficiently low mass to become airborne when a powder material is handled or agitated.

3.2 **dye**, n.—a colorant applied to or formed in a substrate, via the molecularly dispersed state, which exhibits some degree of permanence.

4. Safety Precautions

NOTE: These safety precautions are for information purposes only. The precautions are ancillary to the testing procedures and are not intended to be all inclusive. It is the user's responsibility to use safe and proper techniques in handling materials in this test method. Manufacturers MUST be consulted for specific details such as material safety data sheets

and other manufacturer's recommendations. All OSHA standards and rules must also be consulted and followed.

4.1 Good laboratory practices should be followed. Wear safety glasses in all laboratory areas and a single-use dust respirator while handling powder dyes.

5. Apparatus and Materials

5.1 Funnel, 1.5 mm thick stainless steel, 110 mm diameter, 230 mm stem length with 15 mm stem diameter (see Fig. 1).

5.2 Cylinder, stainless steel, 50 mm diameter, 355 mm tall (approx. capacity

500 mL) with capability of grounding to prevent interference from static electricity (see 11.1).

5.3 Filter paper, Whatman No. 2, 39 mm diameter circle with 16 mm diameter center hole (see 11.2).

5.4 Pipettes, Pasteur (see 11.3).

5.5 Beakers, Griffin, 50 mL.

5.6 Photographic Scale for Rating (see 11.4, Fig. 2).

6. Preparation and Assembly

6.1 Slip a filter paper collar on the funnel stem and position it 100 mm from the bottom of the stem.

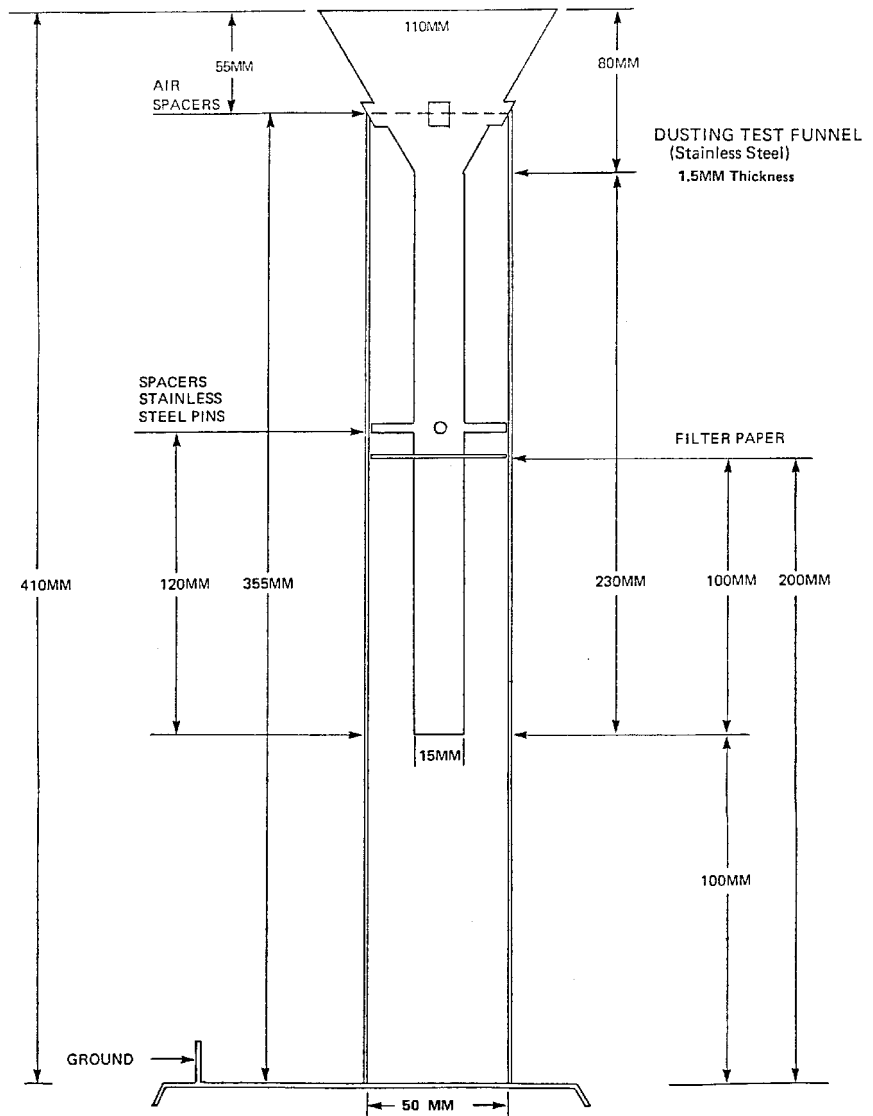

Fig. 1—Dusting test funnel.



Fig. 2—Dusting test scale.

6.2 Moisten the paper collar with three drops of distilled water at points approximately equidistant from one another around the stem of the funnel. Use care to avoid water running down the funnel stem.

6.3 Place the funnel, with wet collar, in the steel cylinder. Ground the cylinder (see 11.5). The paper collar should be 200 mm from the bottom of the steel cylinder.

7. Procedure

7.1 Use a 10 g sample of powder dye, weighing it out as 3.3 g portions, into three 50 mL beakers.

7.2 Pour the three portions of dye onto the side of the funnel at intervals of approximately 2-3 s.

7.3 Allow the apparatus to remain undisturbed for 3 min to avoid erroneous results due to any external effects on the air in the cylinder.

7.4 Remove the funnel and, with scissors, snip off the filter paper collar from its periphery to the stem for easy removal (see 11.6). Air dry the collar by placing it on a sheet of filter paper away from

possible sources of atmospheric “fly” or contaminants.

8. Evaluation

8.1 Compare the specimen with the scale (see 11.4) and assign the appropriate numerical rating. Intermediate ratings; e.g., 4-5 may be estimated.

8.2 The matching standard establishes a numerical rating for degree of dusting. A rating of 1 describes a very dusty material and a rating of 5 describes a non-dusting or minimally dusting dye.

8.3 Duplicate or triplicate tests may be conducted and the average noted.

9. Report

9.1 Report the numerical rating for degree of dusting.

10. Precision and Bias

10.1 *Precision.* Precision for this test method has not been established. Until a precision statement is generated for this method, use standard statistical techniques in making any comparisons of test results

for either *within-laboratory* or *between-laboratory* averages.

10.2 *Bias.* Dusting propensity can only be defined in terms of a test method. There is no independent method for determining the true value. As a means of estimating this property, the method has no known bias.

11. Notes

11.1 Stainless steel funnels and cylinders are available from AATCC, P.O. Box 12215, Research Triangle Park NC 27709; tel: 919/549-8141; fax: 919/549-8933; e-mail: orders@aatcc.org.

11.2 Filter paper collars required for this test are not commercially available but may be prepared in a number of different ways.

11.2.1 Larger circles of paper may be die cut or hand cut to size with scissors and the center hole punched out with a light blow on a #6 cork borer.

11.2.2 A die fabricated to cut the two concentric circles is available from Carolina Steel Rule Die, Inc., 3019 Pacific Ave., Greensboro NC 27406.

11.3 Pasteur Pipettes may be obtained from Fisher Scientific Co. as Borosilicate Disposable Pipettes, Cat. No. 13-678-20A or B.

11.4 The illustration of the dusting scale in the text of this method is inadequate for the evaluation. A standard scale (photographic replicas) must be used and is available from AATCC, P.O. Box 12215, Research Triangle Park NC 27709; tel: 919/549-8141; fax: 919/549-8933; e-mail: orders@aatcc.org.

11.5 The steel cylinder is grounded by connecting one end of a copper conductor (No. 14 solid wire) to the grounding screw at the base of the cylinder and the other end clamped to a metallic (not plastic) water pipe or any metallic electrical conduit.

11.6 Pulling the paper collar off the stem of the funnel without using the scissors causes a “squeegee” effect which could lead to erroneous results.

Carpets: Cleaning of; Hot Water Extraction Method

Developed in 1987 by AATCC Committee RA57; reaffirmed 1988, 1989, 2000, 2005; editorially revised 1991, 1997; revised 1995 (with title change).

Foreword

Over the years, Committee RA57, Floor Covering, has evaluated the various techniques for on-site cleaning of carpets as they have emerged. Information exchanged with professional carpet cleaning organizations led to the selection of the system described in this test method as typical of a majority of actual cleaning operations.

1. Purpose and Scope

1.1 This test method provides a laboratory procedure to clean textile floor coverings by a technique simulating cleaning of installed floor coverings by hot water extraction, sometimes erroneously called "steam cleaning."

1.2 This test method may be used to clean a carpet in a manner that duplicates the most popular (70%) means of actual on-floor cleaning of carpets.

1.3 This test method prepares specimens that can be tested for many properties; e.g., colorfastness, dimensional stability, permanency of finishes, ease of cleaning, etc.

2. Principle

2.1 The test is performed by securing a specimen of carpet, face up, on a floor or a mounting board. An extraction cleaning head is passed over each section of the specimen. The pile is erected with a brush or pile rake and the specimen is dried at room temperature.

3. Terminology

3.1 **carpet**, n.—all textile floor coverings not designated as rugs.

3.2 **carpet pile brush**, n.—a hand operated brush having long, semi-rigid bristles intended specifically for erecting the pile of small areas of carpet. (see also *pile lifter*).

3.3 **cleaning head**, n.—a vacuum head modified with spray nozzles for cleaning solution application. Some types include a powered brush unit to facilitate wetting and soil release.

3.4 **hot water extraction**, n.—a method of cleaning carpet by injecting a heated cleaning solution into the pile and quickly removing the solution and soil by

vacuum. (see also *steam cleaning*).

NOTE: Hot water extraction is often erroneously called "steam cleaning." Hot water is used at a temperature of $60 \pm 3^\circ\text{C}$ ($140 \pm 5^\circ\text{F}$). These temperatures are far below the temperature of steam of 100°C (212°F).

3.5 **pile**, n.—see *pile lifting*.

3.6 **pile lifter**, n.—a vacuum cleaning device with motorized rotating brushes designed to erect and agitate carpet pile to facilitate soil removal. (see also *carpet pile brush*).

3.7 **pile lifting**, n.—the act of erecting the pile tufts of a carpet with a *carpet pile brush*, *pile lifter*, or *pile rake* to allow imbedded soil to be more easily removed and erecting the pile after cleaning to restore a uniform overall appearance. (also called *pile*).

3.8 **pile rake**, n.—a hand tool with smooth circular plastic tines used for pile lifting.

3.9 **rug**, n.—a textile floor covering of limited area which is complete in itself and is intended for use as a partial covering of a floor or another floor covering.

3.10 **steam cleaning**, n.—see the correct term, *hot water extraction*.

3.11 **textile floor covering**, n.—an article having a use-surface composed of textile material and generally used for covering floors.

3.12 **use-surface**, n.—of *textile floor covering*, the part of a textile floor covering directly exposed to foot traffic.

3.13 **wand**, n.—a tool used to deliver cleaning solution to carpets and apply vacuum to remove the solution.

NOTE: A *wand* usually consists of an extension handle and a *cleaning head*. Various types are light weight wand, drag wood (heavy duty) and power wand which has a motorized rotating or vibrating part to aid soil release.

4. Safety Precautions

NOTE: These safety precautions are for information purposes only. The precautions are ancillary to the testing procedures and are not intended to be all inclusive. It is the user's responsibility to use safe, and proper techniques in handling materials in this test method. Manufacturers MUST be consulted for specific and other manufacturer's recommendations. All OSHA standards and rules must also be consulted and followed.

4.1 Good laboratory practices should be followed. Wear safety glasses in all laboratory areas.

4.2 All chemicals should be handled with care.

4.3 Eye protection should be used when mixing, handling or applying the detergent and detergent solutions.

4.4 Gloves or protective hand cream are recommended for handling detergents and solutions.

4.5 Observe operating procedures and precautions by the manufacturer of the extraction machine. Liquid under pressure and high vacuum can cause excessive splashing of liquids and/or hose "kick back."

5. Apparatus and Materials

5.1 AATCC Detergent #171, for all synthetic fiber carpets (see 11.1).

5.2 Hot water extraction unit (see 11.2).

5.3 Carpet brush or pile rake.

5.4 Mounting boards (see 11.3).

6. Test Specimens

6.1 The preferred minimum specimen size is 30×70 cm (12×27 in.) with the pile lay in the 70 cm (27 in.) direction (see 11.4).

6.2 If the entire specimen requires uniform cleaning, a border carpet of similar thickness is necessary for uniform extraction of the cleaning solution.

7. Procedure

7.1 Secure the specimen to the floor or mounting board with staples, tacks or other suitable means (see 11.4).

7.2 Prepare the cleaning solution according to the directions supplied.

7.3 Purge the system of cold cleaning solution before beginning each cleaning cycle.

7.4 Pour 8 L (2 gal) or more of preheated solution, 60°C (140°F), into the empty solution tank of the hot water extraction unit.

7.5 With water-feed spray and vacuum on, and the cleaning head in contact with the carpet surface, draw the cleaning head across the surface of the carpet in a direction against the lay of the pile. Without changing the position of the carpet, place the cleaning head in the same starting position of the carpet surface as before and with only the vacuum on (water-feed spray off) draw the cleaning head across the carpet as in the first pass. These two passes of the cleaning head constitute one cleaning cycle. In most cases, two cleaning cycles will be neces-

sary to obtain measurable results. However, the number of cycles may be increased depending on the degree of soiling and the purpose of the test.

7.6 The wand should be moved at about 46.0 cm/s (1.5 ft/s) to deliver between 0.4-0.6 L/m² (0.10-0.14 gal/yd²) of cleaning solution. The speed of the second (vacuum) stroke should be approximately the same as above, but may be decreased to achieve maximum liquid retrieval. CAUTION: Some jet size - jet height combinations may cause pile distortion from excessive liquid impact (see 11.2.6).

7.6.1 An effective professional unit should remove between 90-95% of the liquid, depending on fiber absorbency. A properly operating vacuum system should leave no more than 40.0 g/m² (1.2 oz/yd²) of liquid (that is in excess of natural regain) in a carpet specimen.

7.7 Should the cleaning of a larger area of carpet than covered by a single cleaning cycle be required, reposition the cleaning head on the carpet so that in successive cleaning cycles the cleaning head will overlap the previously cleaned area by 5 cm (2 in.).

7.8 Erect the pile with a carpet brush or pile rake in the direction opposite to the lay of the pile.

7.9 Remove the specimen from the mounting board or floor and dry it at ambient conditions in a horizontal position.

8. Evaluation

8.1 Specimens which are subjected to the cleaning procedure of this test method

may be tested for many properties; e.g., colorfastness, dimensional change, permanency of finishes, ease of cleaning, etc.

9. Report

9.1 State that the specimens were cleaned according to this procedure.

9.2 Report the number of cleaning cycles used.

9.3 State the pH of the diluted cleaning solution after it has been prepared according to directions provided by the supplier.

9.4 Report evaluation data and cite the test method for each property evaluated.

10. Precision and Bias

10.1 Precision and bias statements are not applicable because data are not generated by this test method.

11. Notes

11.1 AATCC Detergent 171 available from AATCC, P.O. Box 12215, Research Triangle Park NC 27709; tel: 919/549-8141; fax: 919/549-8933; e-mail: orders@aatcc.org.

11.1.1 Dilution:

U.S. 11-17 g/gal of tap water

U.K. 13-18 g/gal (Imperial)

Metric: 3.0-4.5 g/L

11.2 A commercial hot water extraction device of professional quality, either portable, dolly, or truck mount. Small units and "add on" devices are generally unsuitable because of insufficient liquid capacity, delivery pressure, and/or vacuum for liquid retrieval. The device should meet or exceed the following specifications:

11.2.1 The tank shall have a means of maintaining the liquid at 60 ± 3°C (140 ± 5°F) and a thermometer to measure this.

11.2.2 A liquid delivery pump delivering at least 3 L/min (0.75 gal/min) at a pressure of 207 kPa (30 psi) or more.

11.2.3 The liquid recovery vacuum pump shall have a minimum lift of 250 mm (100 in.) sealed and a flow of 43 L/s (90 cfm) open orifice.

11.2.4 A standard floor wand of 25 cm (10 in.) width.

11.2.5 Spray jet(s) to deliver 3.0-4.0 L/min (0.75-1.0 gal/min) with a line pressure of 207 kPa (30 psi). The spray pattern should give even liquid delivery over the entire wand width. There should be no heavy or light streaks. The liquid impact on the face of the carpet should not cause matting or other pile distortion. Jet(s) orifice size and/or distance from the carpet face should be adjusted to avoid pile distortion and give even liquid distribution. EXAMPLE: If spray pattern is too narrow and pile matts, increase height. If pattern is wide enough and pile matts, increase orifice size.

11.2.6 Units suitable for use can be obtained from: Professional Chemicals, Inc., P.O. Box 3138, Tempe AZ 85281; Hydra-Master Corp., 20309-64th Ave., W. Lynnwood WA 98036; Steam Way International, 3020 E. 43rd Ave., Denver CO 80216; Clarke/McGraw Edison, 2800 Estes St., Muskegon MI 49441; and Certified Chemical and Equipment Co., 5366 St. Clair Ave., Cleveland OH 44103.

11.3 The mounting boards should be constructed from 1.27 cm (0.5 in.) CD grade exterior plywood or better. Each board should measure 78.7 × 96.5 cm (31.0 × 38.0 in.).

11.4 The specimen and mounting board size may be adjusted to conform with other tests to be run on the sample. Examples: AATCC Methods 122, Carpet Soiling: Service Soiling Method, or 134, Electrostatic Propensity of Carpets.

Colorfastness to Non-Chlorine Bleach in Home Laundering

Developed in 1988 by AATCC Committee RA60; reaffirmed 1989, 1995, 2002; revised 1990, 1996, 1997, 2003; editorially revised 1994, 2004, 2005.

1. Purpose and Scope

1.1 This test method is designed to evaluate the colorfastness to non-chlorine bleach in home laundering of textiles which are expected to withstand frequent laundering. The fabric color changes resulting from the non-chlorine bleach, detergent solution and abrasive action of five home laundings are evaluated.

1.2 Results of this test method can be used for establishing care instructions. First establish the level of performance with non-chlorine bleach and if an effect is found, then retest with detergent alone. It may be necessary to use a water only wash to separate the effects of components like hardness, pH or chlorine content.

1.3 Since the non-chlorine bleaches currently available contain ingredients other than the non-chlorine bleach; such as fluorescent whitening agents, bluing, etc., it is the total effect of these chemicals on the color change that is being evaluated.

2. Principle

2.1 Specimens are laundered under appropriate conditions of temperature, detergent solution, non-chlorine bleach solution and abrasive action for five home laundering cycles. The laundered specimens are evaluated for color change.

3. Terminology

3.1 **bleach**, n.—*in home laundering*, a product that will clean, whiten, brighten and aid in the removal of soils and stains from textile materials by oxidation that is inclusive of chlorine and non-chlorine products.

3.2 **care instructions**, n.—*in textiles*, a series of directions describing which care practices should refurbish a product without adverse effects and warning of those care practices expected to have a harmful effect (see 12.1).

3.3 **colorfastness**, n.—the resistance of a material to change in any of its color characteristics, to transfer of its colorant(s) to adjacent materials or both, as a result of the exposure of the material to any environment that might be encountered during the processing, testing, stor-

age or use of the materials.

3.4 **laundering**, n.—*of textile materials*, a process intended to remove soil and/or stains by treatment (washing) with an aqueous detergent solution and normally including subsequent rinsing, extracting and drying.

3.5 **non-chlorine bleach**, n.—a bleach that does not release the hypochlorite ion in solution; i.e., sodium perborate, sodium percarbonate.

4. Safety Precautions

NOTE: These safety precautions are for information purposes only. The precautions are ancillary to the testing procedures and are not intended to be all inclusive. It is the user's responsibility to use safe and proper techniques in handling materials in this test method. Manufacturers MUST be consulted for specific details such as material safety data sheets and other manufacturer's recommendations. All OSHA standards and rules must also be consulted and followed.

4.1 Good laboratory practices should be followed. Wear safety glasses in all laboratory areas.

4.2 The 1993 AATCC Standard Reference Detergent WOB may cause irritation. Care should be taken to prevent exposure to skin and eyes.

4.3 Manufacturer's safety recommendations should be followed when operating laboratory testing equipment.

4.4 All chemicals should be handled with care.

4.5 The procedure for determining the oxidant content outlined in 12.8 should be handled only in an adequately ventilated laboratory hood. In preparing, dispensing and handling the reagents, use chemical goggles or face shield, impervious gloves and an impervious apron.

4.6 An eyewash/safety shower should be located nearby and an organic vapor respirator should be available for emergency use.

4.7 Exposure to chemicals used in this procedure must be controlled at or below levels set by governmental authorities (e.g., Occupational Safety and Health Administration's [OSHA] permissible exposure limits [PEL] as found in 29 CFR 1910.1000 amended as of January 1, 1989). In addition, the American Conference of Governmental Industrial Hygienists (ACGIH) Threshold Limit Values (TLVs) comprised of time weighted averages (TLV-TWA), short term exposure limits (TLV-STEL) and ceiling lim-

its (TLV-C) are recommended as a general guide for air contaminant exposure which should be met (see 12.2).

5. Apparatus and Materials

5.1 Automatic washing machine (see 12.3).

5.2 Automatic tumble dryer (see 12.4).

5.3 Conditioning/drying racks with pull-out screens or perforated shelves (see 12.5).

5.4 Ballast of $92 \times 92 \pm 3$ cm ($36 \times 36 \pm 1$ in.) hemmed pieces of bleached cotton sheeting (Wash load ballast type 1) or 50/50 polyester/cotton bleached of plain weave construction (Wash load ballast type 3) (see 12.6).

5.5 1993 AATCC Standard Reference Detergent WOB (see 12.7).

5.6 Facilities for drip and line drying.

5.7 Balance with at least 5 kg (20 lbs) capacity.

5.8 Non-chlorine bleach (see 12.8 and 12.9).

6. Test Specimens

6.1 The weight of the test specimen can influence the results of this test. The amount of fabric dilutes the surface that can be affected. Only one test specimen is to be laundered in a load. For ease in weighing fabrics, the test specimen weight is to be 110.0 ± 10.0 g (0.25 ± 0.02 lb). For garment testing, one garment is to be tested. If the garment weight exceeds the specified load weight of 1.8 kg or 4 lb, the total weight is to be included in the report. See 7.2.2 for exact weight specifications on load.

7. Procedure

7.1 Tables I, II and III summarize washing and drying conditions which can be used to test.

7.2 Washing.

7.2.1 Fill the washer with the specified water volume at the selected water temperature using the normal cycle setting. Measure and record the water hardness in any test.

7.2.2 Add 66 ± 1 g of 1993 AATCC Standard Reference Detergent WOB. Add the amount of the non-chlorine bleach recommended by the manufacturer (see 12.8). Add test specimen and enough ballast to make a 1.8 ± 0.1 kg (4.00 ± 0.25 lb) load. Set the washer on the cycle selected for washing and set the wash timer (see Tables I and II). Start the agitation and independently time the

Table I—Washing and Drying Conditions

Machine Cycle	Washing Temperatures	Drying Procedures
(1) Normal/Cotton Sturdy	(II) 27 ± 3°C (80 ± 5°F)	(A) Tumble:
(2) Delicate	(III) 41 ± 3°C (105 ± 5°F)	i. Cotton Sturdy
(3) Permanent Press	(IV) 49 ± 3°C (120 ± 5°F)	ii. Delicate
	(V) 60 ± 3°C (140 ± 5°F)	iii. Permanent Press
		(B) Line
		(C) Drip
		(D) Screen

Table II—Typical Washing Machine Operating Parameters¹

	Normal	Delicate	Permanent Press
(A) Water Level	68.1 ± 3.8 L (18 ± 1.0 gal)	68.1 ± 3.8 L (18 ± 1.0 gal)	68.1 ± 3.8 L (18 ± 1.0 gal)
(B) Agitator Rate	179 ± 2 spm ²	119 ± 2 spm	179 ± 2 spm
(C) Washing Time	12 min	8 min	10 min
(D) Spin Speed	645 ± 15 rpm ³	430 ± 15 rpm	430 ± 15 rpm
(E) Final Spin Cycle	6 min	4 min	4 min

¹ Per machine specifications.

² spm = strokes per minute.

³ rpm = revolutions per minute.

Table III—Dryer Conditions

	Normal or Cotton/Sturdy	Delicate	Permanent Press
Exhaust Temperature	High 66 ± 5°C (150 ± 10°F)	Low < 60°C (140°F)	High 66 ± 5°C (150 ± 10°F)
Cool Down Time	10 min	10 min	10 min

wash for reproducible results. Advance the dial to the end of the wash cycle and rinse at a temperature below 29°C (85°F). If this rinse temperature is not attainable, record the actual temperature of the rinse water used.

7.2.3 For specimens to be dried by procedures A, B or D, allow washing to proceed automatically through the final spin cycle. Remove test specimens immediately after the final spin cycle, separate any tangled pieces—taking care to minimize distortion—and dry by procedures A, B or D (see Tables I and III).

7.2.4 For specimens to be dried by procedure C, Drip Dry, stop the washer at the end of the final rinse cycle just before the water begins to drain. Remove the specimens soaking wet.

7.3 Drying.

7.3.1 (A) Tumble Dry. Place the washed load (test specimens and ballast) in the tumble dryer, set on the cycle which generates the correct exhaust temperatures as specified in Table III. For fibers that are heat sensitive, lower temperatures consistent with producer's recommendations are required and must be reported. Operate the dryer until the total load is dry. Remove the load immediately after machine stops.

7.3.2 (B) Line Dry. Hang each specimen by two corners with the fabric length

in the vertical direction. Allow the test specimens to hang in still air at room temperature until dry.

7.3.3 (C) Drip Dry. Hang each dripping wet specimen by two corners, with the fabric length in the vertical direction. Allow specimens to hang in still air at room temperature until dry.

7.3.4 (D) Screen Dry. Spread each specimen on a horizontal screen or perforated surface, removing wrinkles but not distorting or stretching, and allow to dry in still air at room temperature.

7.4 Repeat 7.2 and 7.3 for a total of five launderings.

7.5 After drying, condition the specimens for at least 4 h by laying each specimen separately on the screen or perforated shelf of a conditioning rack in an atmosphere of 21 ± 1°C (70 ± 2°F) and 65 ± 2% RH before evaluating color change.

8. Evaluation

8.1 Visual evaluation.

8.1.1 Rate the color change of the test specimens using the Gray Scale for Color Change. (Usage of the scale is discussed in Evaluation Procedure 1.)

Grade 5—negligible or no change as shown in Gray Scale Step 5.

Grade 4.5—change in color equivalent to Gray Scale Step 4-5.

Grade 4—change in color equivalent to Gray Scale Step 4.

Grade 3.5—change in color equivalent to Gray Scale Step 3-4.

Grade 3—change in color equivalent to Gray Scale Step 3.

Grade 2.5—change in color equivalent to Gray Scale Step 2-3.

Grade 2—change in color equivalent to Gray Scale Step 2.

Grade 1.5—change in color equivalent to Gray Scale Step 1-2.

Grade 1—change in color equivalent to Gray Scale Step 1.

9. Interpretation of Results

9.1 This test is a satisfactory end use test for demonstrating the effect of the 1993 AATCC Standard Reference Detergent WOB and non-chlorine bleach on textile materials in home laundering. The color change results will establish a level of performance that can be used to prepare care instructions to meet the requirements of the Federal Trade Commission (see 12.1).

9.2 If a significant color change is observed, an untreated duplicate sample could be retested using either this method with detergent only, or the 2A Test in AATCC Method 61, Colorfastness to Laundering, Home and Commercial: Accelerated, without the addition of non-chlorine bleach. This will determine whether the color change is due to dye instability or a bleach effect.

10. Report

10.1 Report the numerical average color change grade for each specimen tested.

10.2 Report washing procedure (Arabic and Roman Numerals) and drying procedure (capital letter from Table I; [i.e., (1) IIIA (iii)] means NORMAL cycle, wash water temperature of 41 ± 3°C (105 ± 5°F), tumble dry (permanent press).

10.3 Record the brand and quantity of the non-chlorine bleach used.

10.4 Report the oxidant content of the dosage.

10.5 Record the weight of fabric specimen or garment tested.

11. Precision and Bias

11.1 *Interlaboratory Test Data.* An interlaboratory study was carried out in 1986 to establish the precision of this test method for determining the effect of non-chlorine bleach in home laundering on the colorfastness of textile materials.

Four materials were tested separately for five cycles of home laundering in duplicate at each of the five laboratories using one brand of non-chlorine bleach. After completing the laundering, three

Table IV—Critical Differences, Rating Units for Conditions Noted^a

Number of Observations in each Average	Single-Operator Precision	Within-Laboratory Precision	Between-Laboratory Precision
1	0.61	0.85	0.85
3	0.35	0.69	0.69
5	0.27	0.65	0.65

^a The critical differences were calculated using $t = 1.950$, which is based on infinite degrees of freedom.

raters independently assessed the color change on each specimen of each fabric using the Gray Scale for Color Change. The washing and drying conditions were (1)IVa (see Table I for interpretation of code). Each of the 24 × 24 in. specimens that were washed separately ranged in weight from 72-97 g (0.16-0.21 lb). The fabrics were 100% cotton and polyester/cotton. Dyes were direct, pigment and disperse. The color change average grades for the three raters at the five laboratories were 3.33-3.93.

11.2 *Precision.* The components of variance as standard deviations of colorfastness grades were calculated to be as follows:

Single-operator component	0.22
Within-laboratory component	0.21
Between-laboratory component	0.00

For the components of variance reported above, the average of two color change grades should be considered significantly different at the 95% probability level if their difference equals or exceeds the critical differences listed in Table IV.

11.3 *Bias.* The true value of colorfastness to non-chlorine bleach in home laundering can only be defined in terms of a test method. Within this limitation, this method has no known bias.

12. Notes

12.1 Contact Federal Trade Commission, Washington DC 20580 for its Care Labeling of Textile Wearing Apparel and Certain Piece Goods Regulation and the January 2, 1984 amended rules identified as Federal Trade Commission Rule 16 CFR 423.

12.2 Available from Publications Office,

ACGIH, Kemper Woods Center, 1330 Kemper Meadow Dr., Cincinnati OH 45240; tel: 513/742-2020.

12.3 Contact AATCC, P.O. Box 12215, Research Triangle Park NC 27709; tel: 919/549-8141; fax: 919/549-8933; e-mail: orders@aatcc.org, for model number(s) and source(s) of current approved washer(s). Any other washer which is known to give comparable results can be used. Washing machine conditions given in Table II represent the actual speeds and times available on current specified model(s). Other washers may vary in one or more of these settings.

12.4 Contact AATCC, P.O. Box 12215, Research Triangle Park NC 27709; tel: 919/549-8141; fax: 919/549-8933; e-mail: orders@aatcc.org, for model number(s) and source(s) of current approved dryer(s). Any other dryer which is known to give comparable results can be used. Dryer machine conditions given in Table III represent the actual speeds and times available on current specified model(s). Other dryers may vary in one or more of these settings.

12.5 Screen or perforated conditioning/drying racks available from Somers Sheet Metal Inc., 5590 N. Church St., Greensboro NC 27405; tel: 336/643-3477; fax: 336/643-7443. Rack drawings are available from AATCC, P.O. Box 12215, Research Triangle Park NC 27709; tel: 919/549-8141; fax: 919/549-8933; e-mail: orders@aatcc.org.

12.6 Available from Testfabrics, P.O. Box 26, 415 Delaware St., W. Pittston PA 18643; tel: 570/603-0432; fax: 570/603-0433; e-mail: testfabric@aol.com; and Textile Innovators Corp., div. of SDL Atlas L.L.C., P.O. Box 8, 101 Forest St., Windsor NC; tel: 252/794-9703; fax: 252/794-9704; e-mail: tic@sdlatlas.com.

12.7 Available from AATCC, P.O. Box 12215, Research Triangle Park NC 27709; tel: 919/549-8141; fax: 919/549-8933; e-mail: orders@aatcc.org. AATCC Standard Reference Detergent WOB has been changed to a

0% phosphate compact formula named 1993 AATCC Standard Reference Detergent WOB. Critical evaluations made using AATCC Standard Reference Detergent WOB and used for standard comparisons should be repeated using the 1993 AATCC Standard Reference Detergent WOB.

12.8 Non-chlorine bleaches are available under a large number of trade names in supermarkets. Different brands will contain different ingredients and the same ingredients in differing quantities. Follow manufacturer's instruction for recommended usage. In conducting experiments with these materials, since they are blends of materials of different granule sizes and densities, or liquids, it is strongly recommended that sufficient product to conduct a group of experiments in the same time frame be thoroughly mixed in a composite before and during use. Keep in air tight containers. The product used to develop this method was Clorox 2.

12.9 To determine the percent available oxygen in non-chlorine bleaches or synthetic detergent products, grind the granules in a Waring blender prior to weighing. A 3 g sample size is satisfactory for products containing 0.5% available oxygen. For products containing 1.0% available oxygen use 1.5 g sample. Using an analytical balance which is accurate to 0.002 g, weigh 3.000 ± 0.001 g of sample into a 250-300 mL Erlenmeyer flask. Place the sample on a magnetic stirrer protecting it from the light with a cardboard box. Put a hole in the box top that allows a funnel to be used to add chemicals and support it with a ring and stand. Use a Teflon coated stir bar. Add 100 mL of 1.5N sulfuric acid (H₂SO₄), 15.0 mL of 15.0% potassium iodide (150 g KI/L) and 10.0 mL of methylene chloride (CH₂Cl₂). Stir, *in the dark* provided by the cardboard box, for at least 15 min but do not exceed 30 min. Provide indirect light as you titrate slowly but steadily with 0.1N sodium thiosulfate (Na₂S₂O₃) with constant stirring, to a pale yellow. Add about 2.0 mL of starch indicator (5.0% solution) and continue the titration a drop at a time until the disappearance of the blue starch-iodine color.

Calculation:

Percent Available Oxygen =

$$\frac{\text{mL Na}_2\text{S}_2\text{O}_3 \times N \times 0.008 \times 100}{\text{Sample Size}}$$

(where N = Normality of Na₂S₂O₃ solution)
Variation of ± 3% is acceptable within product test.

CMC: Calculation of Small Color Differences for Acceptability

Developed by AATCC Committee RA36 in 1989; reaffirmed 1990; editorially revised and reaffirmed 1991, 2005; revised and reaffirmed 1992; revised 1998. Partly related to ISO 105-J03.

1. Purpose and Scope

1.1 The CMC ($l:c$) formula is a modification of the corresponding CIELAB color-difference formula. It has color-difference symbol ΔE_{cmc} . Even though use of the CIE 1976 $L^*a^*b^*$ (CIELAB) equation provides industry with a 'standard' means of calculating and communicating color differences of trials from their standards (see 8.1), it is recognized that CIELAB color-difference values (ΔE^*) correlate poorly with visual assessments. The lack of correlation is caused by the non-uniformity of CIELAB color space (see Fig. 1). Significantly improved correlation between visual assessments and instrumentally measured color differences is given by the CMC ($l:c$) color-difference formula (see 7.1 to 7.3). The improvement in correlation between visual and instrumental color-difference reports yielded by the CMC ($l:c$) equation will usually permit the adoption of a single-number tolerance for judging the ac-

ceptability of a color match in most situations, regardless of both the color of the standard and the direction of the color difference of any trial from it. Another equation, CIE94 has been considered, but it has not shown any significant improvement over CMC (see 8.2).

1.2 The CMC ($l:c$) formula retains, in modified form, the partitioning of overall color difference into differences in lightness, chroma, and hue components (see Fig. 2) which is present in the CIELAB color-difference formula. Using the ellipsoidal semi-axes (lS_L , cS_C , and S_H) makes the CMC ($l:c$) equation suitable for a wide range of uses.

2. Principle

2.1 The CMC ($l:c$) modification to CIELAB provides a unit of measurement for the acceptance volume about a standard color. This volume takes the shape of an ellipsoid whose semi-axes are lS_L , cS_C , and S_H in the directions of lightness, chroma, and hue differences, respectively, in CIELAB color space. The CMC ($l:c$) formula varies the ratio of the lengths of these three semi-axes systematically throughout CIELAB color space according equality of lengths with visually equal color differences, regardless of both the color of the standard and direc-

tion of difference of any trial from it. Around any given standard color, the ratio $S_L:S_C:S_H$ is fixed regardless of the end use of the trials.

3. Terminology

3.1 **CIE 1976 $L^*a^*b^*$ equation**, n.—a commonly used equation which transforms CIE tristimulus values into a three-dimensional opposed color space. Generally abbreviated as CIELAB (see 8.1).

3.2 **CMC unit**, n.—in color difference evaluation, a measure of acceptability expressed in terms of the boundary for the CMC acceptability ellipsoid of $\Delta E_{cmc} = 1.0$.

3.2.1 CMC is an acronym for the Colour Measurement Committee of The Society of Dyers and Colourists which was largely responsible for the development of the CMC ($l:c$) equation.

3.3 **commercial factor (cf)**, n.—in color difference evaluation, a tolerance (specified in terms of ΔE_{cmc} units) which adjusts all axes of the unit CMC volume equally to create a volume of acceptance for commercial use.

3.4 ΔE_{cmc} , n.—in color difference evaluation, a single number defining the total color difference in CMC units of a trial from a standard.

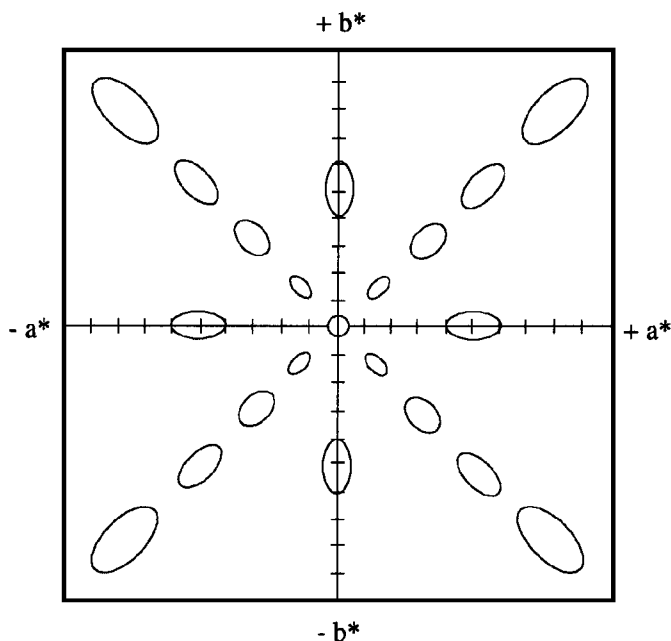

Fig. 1—CMC($l:1$) Unit ellipsoid cross sections in CIELAB a^*b^* diagram.

If CIELAB were uniform, these sections would be equal-sized circles.

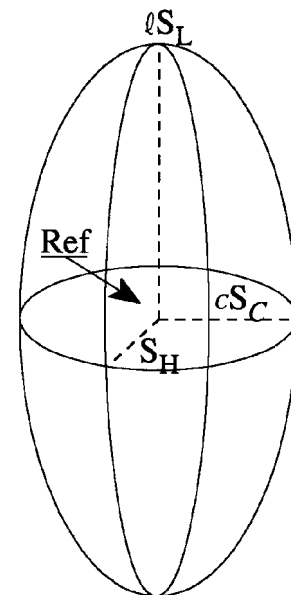

Fig. 2—Unit volume of acceptance.

Distance from standard to surface is one CMC($l:c$) unit.

3.5 semi-axes (ℓS_L , cS_C , and S_H), n.—in color difference evaluation, individual dimensions of the CMC volume which are used to calculate a ΔE_{cmc} value.

3.6 volume of acceptability, n.—in color difference evaluation, the volume of the ellipsoid obtained when each semi-axis (ℓS_L , cS_C , and S_H) is multiplied by cf—creating an agreed upon volume describing the limits of commercial acceptability for the color difference about a standard.

4. Procedure of Calculation

4.1 Calculation of CIELAB values.

4.1.1 Calculate the CIELAB L^* , C_{ab}^* , and h_{ab} values from the CIE tristimulus values X , Y , Z of each specimen using equations 1, 2, 3 and 4:

$$L^* = 116 (Y/Y_n)^{1/3} - 16 \quad (1)$$

if $Y/Y_n > 0.008856$
but

$$L^* = 903.3 (Y/Y_n) \quad (2)$$

if $Y/Y_n \leq 0.008856$
 $a^* = 500[f(X/X_n) - f(Y/Y_n)]$
 $b^* = 200[f(Y/Y_n) - f(Z/Z_n)]$

where $f(X/X_n) = (X/X_n)^{1/3}$

if $X/X_n > 0.008856$
but

$$f(X/X_n) = 7.787(X/X_n) + 16/116$$

if $X/X_n \leq 0.008856$
 $f(Y/Y_n) = (Y/Y_n)^{1/3}$

if $Y/Y_n > 0.008856$
but

$$f(Y/Y_n) = 7.787(Y/Y_n) + 16/116$$

if $Y/Y_n \leq 0.008856$
 $f(Z/Z_n) = (Z/Z_n)^{1/3}$

if $Z/Z_n > 0.008856$
but

$$f(Z/Z_n) = 7.787(Z/Z_n) + 16/116$$

if $Z/Z_n \leq 0.008856$

$$C_{ab}^* = (a^{*2} + b^{*2})^{1/2} \quad (3)$$

$$h_{ab} = \arctan b^*/a^* \quad (4)$$

expressed on a 0-360° scale with the a^* axis being 0° and the b^* axis at 90°.

4.1.2 For these equations, X_n , Y_n , and Z_n are the CIE tristimulus values for the chosen illuminant and observer. The preferred combination is CIE standard illuminant D_{65} and the CIE 1964 supplementary standard (10°) observer. Values for this combination and for some others are given in Table I. Values for combinations not in Table I should be obtained by referring to ASTM E 308 (see 8.3) or,

Table I—Tristimulus Values for Four Illuminant-Observer Combinations

Illuminant-Observer Combinations	Tristimulus Value		
	X_n	Y_n	Z_n
$D_{65}/10^\circ$	94.811	100.000	107.304
$D_{65}/2^\circ$	95.047	100.000	108.883
$C/10^\circ$	97.285	100.000	116.145
$C/2^\circ$	98.074	100.000	118.232

only if the required combination is not therein, CIE 15.2 (see 8.1).

4.2 Calculation of CIELAB color difference values.

4.2.1 Calculate the CIELAB ΔL^* , ΔC_{ab}^* , and ΔH_{ab}^* color difference values as follows, where subscripts S and R refer to the specimen and reference CIELAB values:

$$\begin{aligned} \Delta L^* &= L^*_S - L^*_R \\ \Delta a^* &= a^*_S - a^*_R \\ \Delta b^* &= b^*_S - b^*_R \\ \Delta C_{ab}^* &= C_{ab,S}^* - C_{ab,R}^* \\ \Delta E_{ab}^* &= [(\Delta L^*)^2 + (\Delta a^*)^2 + (\Delta b^*)^2]^{1/2} \\ \Delta H_{ab}^* &= pq[\Delta E_{ab}^*]^2 - (\Delta L^*)^2 - (\Delta C_{ab}^*)^2]^{1/2} \end{aligned}$$

where $p = 1$ if $m \geq 0$ or $p = -1$ if $m < 0$ and $q = 1$ if $|m| \leq 180$ or $q = -1$ if $|m| > 180$ where $m = h_{ab,S} - h_{ab,R}$ in which $|\dots|$ indicates that the positive value is to be used regardless of the sign of the expression between the two lines

4.2.2 An equivalent method of calculating ΔH_{ab}^* is to use Eq. 5:

$$\Delta H_{ab}^* = t[2(C_{ab,S}^* C_{ab,R}^* - a^*_S a^*_R - b^*_S b^*_R)]^{1/2} \quad (5)$$

where $t = 1$ if $a^*_S b^*_R \leq a^*_R b^*_S$ or $t = -1$ if $a^*_S b^*_R > a^*_R b^*_S$

4.3 Calculation of ΔE_{cmc} .

4.3.1 Calculate the color difference in CMC ($\ell:c$) units using Eq. 6:

$$\begin{aligned} \Delta E_{cmc} &= \left[\left(\frac{\Delta L^*}{\ell S_L} \right)^2 + \left(\frac{\Delta C_{ab}^*}{c S_C} \right)^2 \right. \\ &\quad \left. + \left(\frac{\Delta H_{ab}^*}{S_H} \right)^2 \right]^{1/2} \quad (6) \end{aligned}$$

where for the standard:

$$\text{for } L^*_S > 16 \quad S_L = \frac{0.040975 L^*}{1 + 0.01765 L^*}$$

$$\text{for } L^*_S \leq 16 \quad S_L = 0.511$$

$$S_C = \frac{0.0638 C_{ab}^*}{1 + 0.0131 C_{ab}^*} + 0.638$$

$$S_H = (FT + 1 - F) S_C$$

where

$$F = \left[\frac{(C_{ab}^*)^4}{(C_{ab}^*)^4 + 1900} \right]^{1/2}$$

and

$$T = 0.36 + abs [0.4 \cos (35 + h_{ab})]$$

unless h_{ab} is between 164° and 345° then

$$T = 0.56 + abs [0.2 \cos (168 + h_{ab})]$$

For the last two equations, 'abs' indicates the absolute—i.e., positive value—of the term inside the square brackets.

Note: If required, the components of CMC ($\ell:c$) color difference (ΔL_{cmc} , ΔC_{cmc} , and ΔH_{cmc}) may be calculated using the terms in the round brackets in the first line of the above equation, namely:

$$\Delta L_{cmc} = \frac{\Delta L^*}{\ell S_L}$$

$$\Delta C_{cmc} = \frac{\Delta C_{ab}^*}{c S_C}$$

$$\Delta H_{cmc} = \frac{\Delta H_{ab}^*}{S_H}$$

4.3.1.1 When $\ell = 2.0$ this equation fixes the ratio of the three terms ($S_L:S_C:S_H$) to correlate with visual assessment of typical textile samples. Other values of ℓ may be required in cases where the surface characteristics are significantly different. For example, other values may be required when measuring very dark trials, but the user should assume an ℓ value of 2.0 until actual results indicate a need for adjustment. In practice, "c" is always set to unity and it may be omitted from the equation.

4.3.2 Concept of unit volume/tolerance. The equation for $\Delta E_{cmc} \leq 1.0$ describes an ellipsoidal volume, with axes in the direction of lightness, chroma and hue centered about a standard. Ellipsoid semi-axis lengths of ℓS_L , $c S_C$ and S_H calculated for a given standard describe a unit volume of acceptance within which all samples are less than 1.0 ΔE_{cmc} unit from the standard.

NOTE: Size and orientation of the diagram shown in Fig. 2 varies considerably depending on location of standard in color space and is used here as a means of conceptualizing the semi-axes.

4.3.2.1 This volume—and the size and ratio of its semi-axes—become the basis for the establishment of an appropriately sized volume of acceptability for a given commercial situation by the application of a commercial factor (cf) to all dimensions.

4.3.2.2 The Volume of Acceptance is defined by $\Delta E_{cmc} \leq cf$.

4.4 Reporting of results. The use of illuminant D_{65} and 10° observer calculations and ($\ell:c$) ratio of 2:1 are recommended as the standard for calculating ΔE_{cmc} values. If other illuminants, observers or CMC ($\ell:c$) ratios are used they must be specified as part of the value

(i.e., $\Delta E_{cmc(1.37:1), C/2^\circ} = 1.56$ would denote using a 1.37:1 $\ell:c$ ratio, with CIELAB values calculated for illuminant C/2° observer).

5. Interpretation of Results

5.1 ΔE_{cmc} is a single number which represents the number of CMC color difference units of a trial from a standard. Any trial which is compared to its standard will fall into one of three categories:

5.1.1 If ΔE_{cmc} is less than the agreed commercial factor, the trial is acceptable;

5.1.2 If ΔE_{cmc} is close to the agreed commercial factor, the trial is borderline;

5.1.3 If ΔE_{cmc} is greater than the agreed commercial factor, the trial is unacceptable.

5.2 The semi-axes ℓS_L , cS_C and S_H provide a means of describing the “acceptability” of each dimension of color difference (lightness, chroma, hue) in terms of CMC units in each dimension.

5.2.1 In applications which require rating within or about a critical tolerance, multiple levels consisting of ellipsoidal volumes representing various levels of

color difference may be generated. This will result in a set of concentric volumes/tolerances which provide a uniform grading system when correlated to and are associated with a predefined set of terms.

6. Precision and Bias

6.1 An inter-laboratory trial to determine precision and bias of this method was begun in 1998. Results should be available by late 1998.

7. References

7.1 BS6923:1988, British Standard Method for Calculation of Small Colour Difference. Available from British Standards Institution, 2 Park Street, London W1A 2BS, England.

7.2 Clarke, F. J. J., R. McDonald and B. Rigg, Modification to the JPC79 Colour-Difference Formula, *Journal of The Society of Dyers and Colourists*, Vol. 100, 1984, p128-132 and p281-282.

7.3 McDonald, R., Acceptability and Perceptibility Decisions Using the CMC Colour Difference Formula, *Textile*

Chemist and Colorist, Vol. 20, No. 6, 1988, p31-37, and Errata, Vol. 20, No. 8, 1988, p10.

8. Notes

8.1 CIE Publication No. 15.2, *Colorimetry*, Second Edition, 1986. Available from U.S. National Committee, CIE c/o Mr. Robert A. McCully, Philips Lighting Co., P.O. Box 6800, Somerset NJ 08875-6800.

8.2 McDonald, Roderick and Kenneth J. Smith, “CIE94—A New Colour Difference Formula,” *Journal of the Society of Dyers and Colourists*, Vol. 111, No. 12, Dec. 1995, p376.

8.3 ASTM E 308, *Practice for Computing the Colors of Objects by Using the CIE System*, available from ASTM, 100 Barr Harbor, West Conshohocken PA 19428.

8.4 Simon, F.T., *die Farbe*, Vol. 10, 1961, p225.

8.5 Harold, R. W., *Textile Chemist and Colorist*, Vol. 19, No. 12, 1987, p23.

8.6 The value of 1.0 for the constant c in the formula is mandatory in AATCC Method 173. It is also recommended in the corresponding ISO test method 105-J03 but is given in a note and thereby not mandatory. AATCC has petitioned ISO to make it also mandatory. If and when this happens the two methods can again be considered technically equivalent.

Appendix A. Computer Program

```
10 'CMC (L:C) COLOR DIFFERENCE FORMULA
20 '#####
30 'Input data and LPRINT results
40 '#####
50 INPUT "Input CMC (l:c) weighting factors 'l', 'c' "; L, C
60 INPUT "Input X,Y,Z of standard"; X(1), X(2), X(3)
65 LPRINT "X,Y,Z of standard"; X(1), X(2), X(3): GOSUB 160: L1=CL: A1=CA: B1=CB
70 INPUT "Input X,Y,Z of trial"; X(1), X(2), X(3)
75 LPRINT "X,Y,Z of trial "; X(1), X(2), X(3): GOSUB 160: L2=CL: A2=CA: B2=CB
80 GOSUB 230
90 LPRINT "L*,a*,b*, Hue angle of standard "; L1, A1, B1, H1
100 LPRINT "L*,a*,b*, Hue angle of trial "; L2, A2, B2, H2
110 LPRINT "DL/lSl DC/cSc DH/Sh DEcmc("; l; ":" c ") "
120 LPRINT DL; DC; DH; DE: LPRINT : GOTO 60
130 '#####
140 'Calculate L*, a*, b* values (d65/10)
150 '#####
160 X(1) = X(1) / 94.811: X(2) = X(2) / 100: X(3) = X(3) / 107.304
170 FOR I = 1 TO 3: IF X(I) < 8.856001E-03 THEN FX(I) = 7.787*X(I)+16 /116
    ELSE FX(I)=X(I) ^ ( 1 / 3 )
180 NEXT
190 CL = 116 * FX(2) - 16: CA = 500 * (FX(1) - FX(2)): CB = 200 * (FX(2) - FX(3)): RETURN
200 '#####
210 'Calculate CMC color difference
220 '#####
230 DL=L2-L1: C1=SQR(B1*B1+A1*A1): C2=SQR(B2*B2+A2*A2): DC=C2-C1
240 S1 = DL*DL+(A2-A1)*(A2-A1)+(B2-B1)*(B2-B1)
250 DH =0: AA=S1-DL*DL-DC*DC: IF AA <= 0 THEN 260 ELSE DH = SQR(AA)
260 IF (A2*B2) =0 THEN 280 ELSE H2 =180-SGN(B2)*90 -ATN(A2/B2)*57.3
270 GOTO 300
280 BB2 = SGN(ABS(B2)): AA2 = SGN(A2 + B2)
290 H2 = 90 * (BB2 - AA2 + 1)
300 IF (A1*B1) =0 THEN 320 ELSE H1 =180-SGN(B1)*90-ATN(A1/B1)*57.3
310 GOTO 340
320 BB1 = SGN(ABS(B1)): AA1 = SGN(A1 + B1)
330 H1 = 90 * (BB1 - AA1 + 1)
340 IF H1 <= 164 OR H1 >= 345 THEN 350 ELSE GOTO 360
350 T = .36 + ABS(.4 * COS((H1 + 35) / 57.3)): GOTO 370
360 T = .56 + ABS(.2 * COS((H1 + 168) / 57.3))
370 S1 = .040975 * L1 / (1 + .01765 * L1): IF L1 <= 16 THEN LET S1 = .511
380 Sc = .0638*C1/(1+.0131*C1)+.638: F =SQR(C1^ 4/(C1^4+1900)): Sh =Sc*(T*F+1-F):
    DL =DL/(l*S1): DC =DC/(c*Sc): DH=DH/Sh
385 DA = H2 - H1: IF ABS(DA) > 180 THEN Y1 = -1 ELSE Y1 = 1
386 Y2 = Y1 * DA: IF Y2 <= 0 THEN DH = -DH
390 DE = SQR(DL * DL + DC * DC + DH * DH)
400 RETURN
```

Appendix B. Representative Test Data

To help check computer programs giving ΔE_{cmc} values from the CMC equation, some representative test data are given in Table II. The data are for illuminant D_{65} and the 10° observer using $X_n = 94.811$, $Y_n = 100.00$, $Z_n = 107.304$ (from Table I). The six reference pair colors shown are red, blue, yellow, green, grey, and another red. The $l:c$ ratio used is 2:1.

Table II—Test Data for the CMC(2:1) Equation ($D_{65}/10$)

Pair	Tristimulus Values			CIELAB Values			ΔE_{cmc}
	<i>X</i>	<i>Y</i>	<i>Z</i>	<i>L*</i>	<i>a*</i>	<i>b*</i>	
1	69.556	70.797	67.146	87.39	5.32	7.19	0.42
	68.614	69.698	65.942	86.85	5.59	7.29	
2	53.180	57.467	66.036	80.44	-3.35	-3.84	0.45
	54.385	58.760	67.111	81.16	-3.35	-3.52	
3	63.089	67.667	23.126	85.84	-2.45	55.67	0.27
	61.950	66.366	22.565	85.18	-2.26	55.52	
4	23.178	28.245	21.074	60.11	-15.42	14.97	0.97
	21.896	27.060	20.137	59.03	-16.64	14.86	
5	12.938	13.590	16.071	43.64	0.35	-3.39	0.81
	12.168	12.737	15.221	42.36	0.64	-3.68	
6	14.640	11.100	11.060	39.75	27.95	2.35	2.33
	14.520	11.190	12.220	39.90	26.57	-0.57	

Antimicrobial Activity Assessment of Carpets

Developed in 1991 by Committee RA31; revised 1992; editorially revised and re-affirmed 1993; reaffirmed 1998; editorially revised 2004.

1. Purpose and Scope

1.1 This test method is designed to determine the antimicrobial activity of new carpet materials and consists of three procedures:

1.1.1 A qualitative antibacterial assessment.

1.1.2 A quantitative antibacterial assessment.

1.1.3 A qualitative antifungal assessment.

1.2 This test method may also be used to evaluate the effect of a cleaning process (agreed upon by the interested parties) on the antimicrobial resistance of carpets.

2. Principle

2.1 This test method consists of three procedures, the principles of which are given in Sections 6, 14 and 22.

3. Terminology

3.1 **activity**, n.—*of an antimicrobial agent*, a measure of effectiveness of the agent.

3.2 **antibacterial agent**, n.—any chemical which kills bacteria (bactericide) or interferes with the multiplication, growth or activity of bacteria (bacteriostat).

3.3 **antifungal agent**, n.—any chemical which kills or inhibits the growth of fungi.

3.4 **antimicrobial agent**, n.—any chemical which kills or inhibits the growth of microorganisms.

3.5 **bacterial resistance**, n.—*in textiles*, resistance to the development of visible bacterial growth and accompanying odors, resulting from bacterial degradation of fibers or soil on them, as distinguished from musty fungal odors.

3.6 **mildew resistance**, n.—*in textiles*, resistance to the development of unsightly fungal growths and accompanying unpleasant, musty odors on carpet materials exposed to conditions favoring such growths.

3.7 **rot resistance**, n.—*in textiles*, resistance to deterioration of a carpet material as a result of fungal growth in or on it.

3.8 **zone of inhibition**, n.—clear area of no growth of a microorganism, cultured onto the surface of agar growth medium, in proximity to the borders of a specimen placed in direct contact with

this agar surface.

NOTE: A zone of inhibition occurs as result of the diffusion of an antimicrobial agent from the specimen.

4. Safety Precautions

NOTE: These safety precautions are for information purposes only. The precautions are ancillary to the testing procedures and are not intended to be all inclusive. It is the user's responsibility to use safe and proper techniques in handling materials in this test method. Manufacturers MUST be consulted for specific details such as material safety data sheets and other manufacturer's recommendations. All OSHA standards and rules must also be consulted and followed.

4.1 This test should be performed only by trained personnel. The U.S. Department of Health and Human Services publication *Biosafety in Microbiological and Biomedical Laboratories* should be consulted (see 27.1).

4.2 CAUTION: Some of the microorganisms used in these tests are allergenic and pathogenic; i.e., capable of infecting humans and producing disease. Therefore, every necessary and reasonable precaution must be taken to eliminate this risk to the laboratory personnel and to personnel in the associated environment. Wear protective clothing, respiratory protection, and impervious gloves when working with the organisms. NOTE: Choose respiratory protection that prevents penetration by the spores.

4.3 Good laboratory practices should be followed. Wear safety glasses in all laboratory areas.

4.4 All chemicals should be handled with care.

4.5 An eyewash/safety shower should be located nearby for emergency use.

4.6 Sterilize all contaminated samples and test materials prior to disposal.

4.7 Exposure to chemicals used in this procedure must be controlled at or below levels set by government authorities (e.g., Occupational Safety and Health Administration's [OSHA] permissible exposure limits [PEL] as found in 29 CFR 1910.1000 of January 1, 1989). In addition, the American Conference of Governmental Industrial Hygienists (ACGIH) Threshold Limit Values (TLVs) comprised of time weighted averages (TLV-TWA), short term exposure limits (TLV-STEL) and ceiling limits (TLV-C) are recommended as a general guide for air contaminant exposure which should be met (see 27.2).

5. Uses and Limitations

5.1 This test method is designed for use only for new carpets and must not be used for carpets that have been laid down and worn.

I. Qualitative Assessment of Antibacterial Activity on Carpets: Single Streak Method

6. Principle

6.1 Specimens of the test material, including corresponding untreated controls of the same material (if available but not required), are placed in intimate contact with nutrient agar which has been previously streaked with a bacterial culture. After incubation, a clear area of interrupted growth underneath and along the sides of the test material indicates antibacterial activity of the specimen. Standard strains of bacteria are used with *Staphylococcus aureus* (Gram positive) and *Klebsiella pneumoniae* (Gram negative), the representative organisms.

7. Test Organisms

7.1 *Staphylococcus aureus*, American Type Culture Collection No. 6538 (see 27.3).

7.2 *Klebsiella pneumoniae*, American Type Culture Collection No. 4352 (see 27.3).

8. Culture Medium

8.1 Suitable broth/agar media are Nutrient, Trypticase Soy and Brain-Heart Infusion (BHI).

8.2 Nutrient Broth

Beef Extract	3 g
Peptone	5 g
Distilled water	to 1000 mL

8.3 Heat to a boil to disperse ingredients. Adjust to pH 6.8 with 1*N* sodium hydroxide (NaOH) solution. (This is not necessary if prepared, dehydrated medium is used.)

8.4 Dispense in 10 mL amounts in conventional bacteriological culture tubes (i.e., 125 × 17 mm) plug and sterilize at 103 kPa (15 psi) for 15 min.

8.5 Nutrient Agar (see 27.4). Add 1.5% bacteriological agar to nutrient broth. Heat to boiling. Check pH and adjust to 7.0-7.2 using NaOH solution if necessary. Dispense in 15 mL amounts in conventional bacteriological culture tubes, plug and sterilize at 103 kPa (15 psi) for 15 min.

9. Maintenance of Culture of Test Organisms

9.1 Using a 4 mm inoculating loop, transfer the culture daily in nutrient broth for not more than two weeks. At the conclusion of two weeks, make a fresh transplant from stock culture. Incubate cultures at $37 \pm 2^\circ\text{C}$ ($99 \pm 3^\circ\text{F}$).

9.2 Maintain stock cultures on nutrient agar slants. Store at $5 \pm 1^\circ\text{C}$ ($41 \pm 2^\circ\text{F}$) and transfer once a month to fresh agar (see 27.5).

10. Test Specimens

10.1 Test specimens (non-sterile) are cut by hand or with a die. They may be any convenient size although oblong specimens cut 25×50 mm are recommended.

10.2 If possible, test a specimen of the same material treated in exactly the same way with whatever other finishing agents were used, but without the antibacterial agent. However, this is not essential for the validity of the test. Many standard finishing chemicals will give strong antibacterial activity even after many cleanings.

11. Procedure

11.1 If durability data are desired, carpet specimens must be tested before and after being cleaned by a test method agreed upon by the interested parties.

11.2 Dispense sterilized nutrient agar cooled to $45 \pm 2^\circ\text{C}$ ($113 \pm 4^\circ\text{F}$) by pouring 15.0 ± 2.0 mL into each 100.0 mm diameter flat bottomed Petri dish. Allow agar to gel firmly before inoculating.

11.3 Prepare inoculum by transferring 1.0 ± 0.1 mL of a 24 h broth culture into 9.0 ± 0.1 mL of sterile distilled water contained in a test tube or small flask. Mix well using appropriate agitation.

11.4 Using a 4 mm inoculating loop, load one loopful of the diluted inoculum and transfer it to the surface of the sterile agar plate by making one long streak of approximately 75 mm in length across the center of the plate. Do not break the surface of the agar while making the streak.

11.5 Gently press the test specimen transversely across the inoculum streak to ensure intimate contact with the agar surface. An easy technique is to press the specimen to the agar surface with a biological section lifter or with a spatula which has been sterilized in a flame and then air-cooled immediately before use. Test both the pile (face fibers) and the backing of the carpet on separate agar plates.

11.6 Incubate the plates at $37 \pm 2^\circ\text{C}$ ($99 \pm 3^\circ\text{F}$) for 18-24 h.

12. Evaluation and Report

12.1 Examine the incubated plates for interruption of growth along the streak of inoculum beneath the specimen and for a clear zone of inhibition beyond the speci-

men edge. The width of the zone of inhibition around the test specimen may be calculated using the following equation:

$$W = (T - D)/2$$

where:

W = width of clear zone of inhibition in mm

T = total diameter of test specimen and clear zone in mm

D = diameter of the test specimen in mm

12.2 The criterion for passing the test must be agreed upon by the interested parties. To constitute acceptable antibacterial activity, there must be no bacterial colonies directly under the sample in the contact area.

12.3 Report the results of testing the carpet both before and after cleaning. The number of cleanings is to be agreed upon by the interested parties.

12.4 The size of the zone cannot be construed as a quantitative evaluation of antibacterial activity. The report of results will include an observation of zones of inhibition and growth under the specimen if present.

13. Precision and Bias

13.1 A precision and bias statement is not applicable because data are not generated by this method.

II. Quantitative Assessment of Antibacterial Activity on Carpets

14. Principle

14.1 This test method provides a quantitative procedure for the evaluation of the degree of antibacterial activity.

14.2 Test carpets are inoculated with the test organisms. After incubation, the bacteria are eluted from the swatches by shaking in known amounts of liquid. The number of bacteria present in this liquid is determined, and the percent reduction by the specimen is calculated (see 27.7).

15. Test Organisms

15.1 See Section 7.

16. Culture Medium

16.1 See Section 8.

17. Maintenance of Culture of Test Organisms

17.1 See Section 9.

18. Test Specimens

18.1 Cut a circular disc of approximately 48 mm in diameter from the test carpet (preferably with a steel die). Place the disc in a 250 mL wide-mouth glass jar with screw cap. The carpet disc should lie flat at the bottom of the jar.

18.1.1 An uninoculated treated carpet may be used to determine the level of background organisms present on the carpet.

18.1.2 Do not sterilize carpet samples prior to testing. Sections 18.1.1 and 20.3 address any problems that might arise due to the presence of background organisms on the carpet.

19. Procedure

19.1 If durability data are required, test carpet specimens before and after being cleaned in accordance with a method agreed upon by the interested parties.

19.2 Apply 0.1-0.5 mL of an 18-24 h broth bacterial inoculum adjusted to $1-2 \times 10^5$ CFU on the prewetted carpet fibers. The dilution of the test organism may be prepared in sterile 0.85% saline solution or suitable buffer if a steady-state culture is needed during the contact period. If, however, this test is to be performed under in-use conditions, use nutrient broth as the dilution medium. The carpet disc may be prewetted by dipping it in sterile deionized water or in water containing 0.05% of a non-bacteriocidal wetting agent (see 27.6) and then briefly blotting it on filter paper.

19.3 Inoculate the carpet fibers evenly using a sterile pipette and place the specimen in a glass jar. Screw the jar top on tightly to prevent evaporation.

19.4 As soon as possible after inoculation (0 contact time), add 100 ± 0.1 mL of neutralizer solution to the jar (see 27.9).

19.5 Shake the jar, either mechanically or by hand, vigorously for 1 min. Make serial dilutions and plate (in duplicate) on nutrient (or appropriate) agar. Dilutions of 10^0 , 10^1 and 10^2 are usually suitable.

19.6 The neutralizer solution should include ingredients to neutralize the specific antibacterial carpet treatment and to adjust the pH to 6-8. Report the neutralizer used.

19.7 Incubation over contact periods. Incubate additional jars containing inoculated carpet discs at $37 \pm 2^\circ\text{C}$ ($99 \pm 3^\circ\text{F}$) for 6-24 h. Similar jars may be incubated over other periods (i.e., 1 or 6 h) to provide information about the bacteriocidal activity of the treatment over such periods.

19.8 Sampling of inoculated and incubated swatches. After incubation, add 100 ± 0.1 mL of neutralizer solution to jars containing treated carpet discs. Shake the jars vigorously for 1 min. Make serial dilutions and plate (in duplicate) on nutrient (or appropriate) agar. Dilutions of 10^0 , 10^1 and 10^2 are usually suitable for treated test specimens. Several different dilutions may be required for untreated control carpets depending on the incubation period.

19.9 Incubate all plates for 24 h at $37 \pm 2^\circ\text{C}$ ($99 \pm 3^\circ\text{F}$).

20. Evaluation

20.1 Report bacterial counts as the number of bacteria per specimen not as the number of bacteria per mL of neutralizer solution. Report 0 counts at 10^0 dilution as "less than 100."

20.2 Calculate percent reduction of bacteria by the specimen treatments by one of the following formulas:

- 1) $100(B - A)/B = R$
- 2) $100(C - A)/C = R$
- 3) $100(D - A/D) = R$

where:

A = the number of bacteria recovered from the inoculated treated test carpet in the jar incubated over the desired contact period.

B = the number of bacteria recovered from the inoculated treated test carpet in the jar immediately after inoculation (at 0 contact time).

C = the number of bacteria recovered from the inoculated untreated control carpet in the jar immediately after inoculation (at 0 contact time). If *B* and *C* are not similar, the larger number should be used. If *B* and *C* are not significantly different, $(B + C)/2$ should be used.

D = $(B + C)/2$

R = % reduction

20.3 If an untreated control for carpet is not available, use the following calculation which allows for any background organisms that might interfere with the test:

$$Bg = 100 \{(B - E) - (A - F)/B - E\}$$

where:

A, *B* = (see 20.2).

E = the number of bacteria initially (0 contact time) recovered from the uninoculated, treated test carpet (existing background organisms).

F = The number of bacteria are covered from the uninoculated, prewet treated test carpet after incubation in the jar over the desired contact period (existing background organisms after contact period).

Bg = background organisms

20.4 The criterion for passing the test must be determined by the interested parties.

20.5 Report the dilution medium used.

20.6 Report the results of testing the carpet both before and after cleaning. The number of cleanings is to be determined by the interested parties.

21. Precision and Bias

21.1 Studies (see 27.8) indicate the following *within-laboratory* precision of the Standard Plate Count (SPC) Test: (a) *among-analyst* variation of 18%, and (b) *within-analyst* variation of 8%.

III. Antifungal Activity Assessment of Carpet Materials: Mildew and Rot Resistance of Carpet Materials

22. Principle

22.1 The carpet is subjected to the growth of a common fungus on a nutrient agar medium.

23. Test Specimens

23.1 Cut 38.0 ± 1.0 mm (1.5 ± 0.04 in.) diameter discs from the sample. Other shapes and sizes can be used provided the anticipated sizes of growth-free zones are taken into consideration.

24. Test Procedure

24.1 If durability data are required, carpet specimens must be tested before and after being cleaned in accordance with a method agreed upon by the interested parties.

24.2 Organism: *Aspergillus niger*, American Type Culture Collection No. 6275 (see 27.1).

24.3 Culture medium: Sabouraud dextrose agar (see 27.2).

24.4 Inoculum: Add scrapings from a slant of ripe (7-14 days) fruiting culture of *Aspergillus niger* grown on the Sabouraud dextrose agar to a sterile Erlenmeyer flask containing 50 ± 2 mL of sterile water and a few glass beads. Shake the flask thoroughly to bring the spores into suspension. With the aid of a hemocytometer or a Petroff-Hausser bacteria counter, adjust the inoculum to contain one million conidia per milliliter, using sterile distilled water.

24.5 Inoculation: Distribute 1.0 ± 0.1 mL of the inoculum over the surface of the agar. Prewet the carpet fibers by dipping the carpet disc in sterile deionized water or in water containing 0.05% of a nonionic wetting agent (see 27.6), and then briefly blotting on filter paper. Distribute evenly over each disc 0.2 mL of fungal spore inoculum by means of a sterile pipette. Inoculate the carpet specimens with the face fibers up and also with the fibers down in separate petri dishes. Incubate the inoculated plates at $28 \pm 1^\circ\text{C}$ ($82 \pm 2^\circ\text{F}$) for seven days. Longer periods of incubation may be used to provide information about antifungal activity.

25. Evaluation and Report

25.1 Assess the activity of the carpet as follows:

25.1.1 From the plate with the specimen whose pile is down and whose backing is up, observe and measure the size of any growth-free zone (in mm) produced by the pile fibers. Also from the same plate, record fungal growth on the backing according to the scheme below.

25.1.2 From the other plate with the

specimen whose backing is down and whose pile is uppermost, observe and measure the size of any growth-free zone (in mm) from the backing and score the fungal growth on the pile side according to the scheme given below.

25.1.3 Scoring Scheme:

Observed Growth on Specimen

No growth (if present, report the size of the growth-free zone in millimeters)

Microscopic Growth (visible only under the microscope)

Macroscopic Growth (visible to the eye)

26. Precision and Bias

26.1 A precision and bias statement is not applicable because data are not generated by this method.

27. Notes and References

27.1 American Type Culture Collection, P.O. Box 1549, Manassas VA 20108; tel: 703/365-2700; fax: 703/365-2701.

27.2 Dehydrated agar may be obtained from Difco Laboratories, 920 Henry St., Detroit MI 48201. Dehydrated agar and broth can be custom formulated, upon request, from Baltimore Biological Laboratories, 250 Schilling Cir., Cockeysville MD 21030.

27.3 Consistent and accurate testing requires maintenance of a pure, uncontaminated, non-mutant test culture. Avoid contamination by using good sterile technique in plating and transferring. Avoid mutation by strict adherence to monthly stock transfers. Check culture purity by making streak plates periodically and observing for single species-characteristic type of colonies.

27.4 Publication available from U.S. Department of Health and Human Services CDC/NIH-HHS Publication No. (CDC) 84-8395.

27.5 Booklet available from Publications Office, ACGIH, Kemper Woods Center, 1330 Kemper Meadow Dr., Cincinnati OH 45240; tel: 513/742-2020.

27.6 Triton™ X-100 (Union Carbide Chemicals and Plastics Co., 39 Old Ridgebury Rd., Danbury CT 06817) has been found to be a good wetting agent. Suitable alternatives are dioctyl sodium sulfosuccinate or N-methyltauride derivatives.

27.7 The presence of antimicrobials and/or monomers in the backing of some carpets whose face fibers have not been treated may influence the results of the antibacterial quantitative test method. Positive and favorable results from this test method are not sufficient to qualify a carpet as being antimicrobial. A U.S. EPA registered biocide must be used in some part of the carpet before an antimicrobial claim can be made.

27.8 Peeler, J. T., J. W. Leslie and J. W. Messer, Replicate counting errors by analysts and bacterial colony counters. *Journal of Food Protection*, Vol. 45, 1982, pp238-240.

27.9 The following are examples of ingredients and their concentrations that may be added to the culture medium to neutralize inhibitory substances present in the sample: soy lecithin, 0.5%; and Polysorbate™ 20 and 80, 4.0% (ICI Americas Inc., Concord Pike and New Murphy Rd., Wilmington DE 19897; tel: 800/456-3669; fax: 302/652-8836).

Stain Resistance: Pile Floor Coverings

Developed in 1991 by AATCC Committee RA57; reaffirmed 1992; reaffirmed and editorially revised 1993, 1998, 2003.

1. Purpose and Scope

1.1 This test method is used to determine the resistance to staining by acid food colors on pile floor coverings.

2. Principle

2.1 A specimen of pile floor covering is stained with a small volume of a diluted aqueous solution of Food Drug & Cosmetic (FD&C) Red 40 adjusted to an acid pH. After allowing the stained specimen to remain at controlled conditions for 24 ± 4 h, it is rinsed in water to remove all unused FD&C Red 40 dye. Any residual stain is assessed after drying.

3. Terminology

3.1 **stainblocker**, n.—a chemical substance which, when applied to a textile substrate, imparts partial or total resistance to staining.

3.2 **stain**, n.—for pile floor covering, a discoloration due to a color adding material, such as food or liquid, that exhibits resistance to removal by standard cleaning methods.

4. Safety Precautions

NOTE: These safety precautions are for information purposes only. The precautions are ancillary to the testing procedures and are not intended to be all inclusive. It is the user's responsibility to use safe and proper techniques in the handling of materials in this test method. Manufacturers MUST be consulted for specific details such as material safety data sheets and other manufacturer's recommendations. All OSHA standards and rules must also be consulted and followed.

4.1 Good laboratory practices should be followed. Wear safety glasses in all laboratory areas.

4.2 All chemicals should be handled with care.

5. Apparatus and Materials

5.1 AATCC stain cup and 50 mm (2.0 in.) diam staining ring (see 12.1 and Fig. 1)

5.2 AATCC Red 40 Stain Scale (see 12.1 and Fig. 2)

5.3 FD&C Red 40 (C.I. Food Red 17)

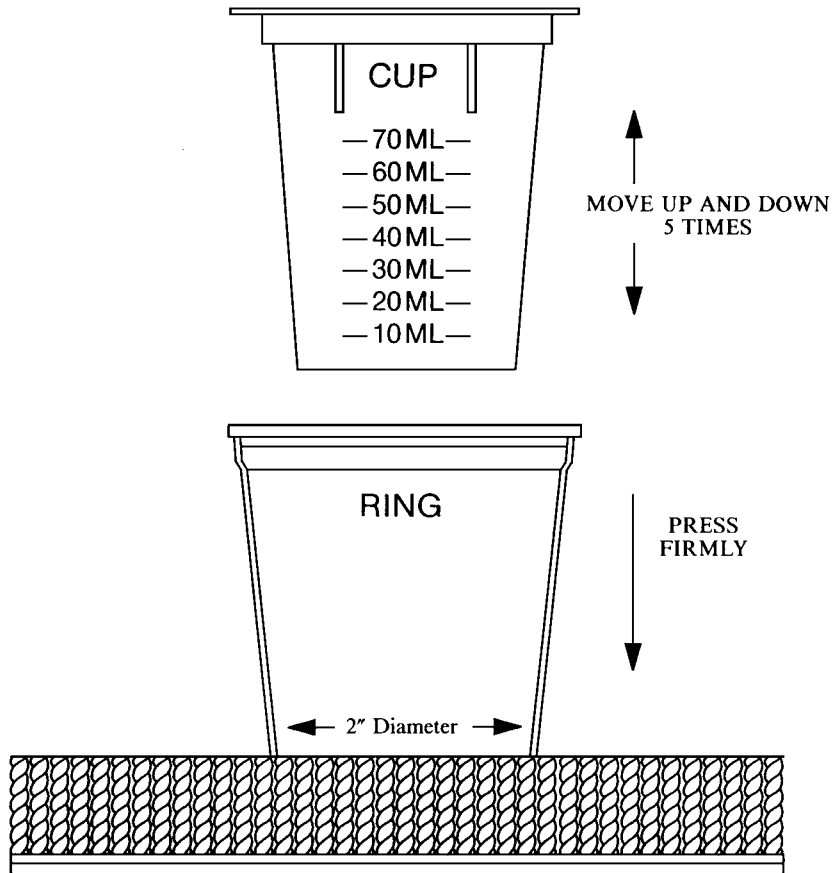

Fig. 1—AATCC stain cup and ring.

(see 12.1)

5.4 Citric acid (technical grade or better)

5.5 Deionized or distilled water

5.6 pH meter

5.7 Buffer solutions, pH 3.0 and 4.0

6. Staining Solution

6.1 Weigh 100 ± 1 mg of FD&C Red 40 and dissolve in $1 \text{ L} \pm 10$ mL of distilled or deionized water at $24 \pm 3^\circ\text{C}$ ($75 \pm 5^\circ\text{F}$).

6.2 Adjust the pH of this solution to 2.8 ± 0.1 with citric acid (approximately 3.2 g). Check the pH with a pH meter, calibrated with pH 3.0 and 4.0 buffer solutions. pH paper must not be used because of its lack of accuracy. If the pH of the prepared staining solution is below 2.7 discard this solution and prepare a new one.

7. Test Specimen

7.1 Cut one specimen at least 150 mm (6 in.) square for each test to be run.

7.2 Remove any extraneous surface materials by brushing and or vacuuming.

8. Procedure

8.1 Condition all test specimens, pile side up, on a nonabsorbent surface for 24 h at standard conditions of $21 \pm 1^\circ\text{C}$ ($70 \pm 2^\circ\text{F}$) and $65 \pm 2\%$ RH. Avoid contamination by contact with extraneous materials (see 12.2).

8.2 Place the 50 mm (2 in.) diameter staining ring in the center of the test specimen. While pressing down on the ring pour 20 mL of the staining solution into the center of the ring. Press the bottom of the stain cup through the ring into the pile, moving it up and down 5 times to facilitate wetting of the pile fiber from top to bottom. Do not rotate or twist the cup inside the ring since this may result in surface abrasion which may remove the stainblocker from the fiber surface. Carefully remove the staining ring and stain cup.

8.3 Recondition the stained specimen for 24 ± 4 h in a flat position, pile side up, at standard conditions of $21 \pm 1^\circ\text{C}$ ($70 \pm 2^\circ\text{F}$) and $65 \pm 2\%$ RH (see 12.2). Avoid any air draft which could result in an accelerated drying of the stained surface.

8.4 Rinse the stained specimen with running water at $21 \pm 6^\circ\text{C}$ ($70 \pm 10^\circ\text{F}$) until the rinse water is clear which indicates removal of all unfixed red dye. Make sure to rinse the backing thoroughly for removal of red dye. Removal of unfixed surface red dye is enhanced by squeezing the specimen in the rinse water.

8.5 Extract (centrifuge or vacuum) the wet specimen to remove excess water.

8.6 Oven dry the test specimen in a flat position, pile side up, at $100 \pm 5^\circ\text{C}$ ($212 \pm 9^\circ\text{F}$) for 90 min maximum or allow to air dry. NOTE: Excessive time in the oven can cause discoloration of the specimen.

8.7 If red dye wicks to the surface during drying, repeat 8.4, 8.5 and 8.6.

9. Evaluation of Results

9.1 Rate the stain resistance of the test specimen by use of the AATCC Red 40 Stain Scale, where a grade of 10 is no staining and 1 is severely stained (see 12.3).

9.2 Rotate the specimen and/or gently brush the pile to produce the maximum display of visual red stain. Place the Red 40 Stain Scale over the test specimen with the stained area of the test specimen between the two reference columns and the non-stained portion (original) of the test specimen directly under the numbered colored film square.

9.3 Illuminate the surfaces with north sky light or equivalent source with illumination of 538 lx (50 lumens per square foot) or more. The light should be incident upon the surfaces at $45 \pm 5^\circ$ and the direction of viewing $90 \pm 5^\circ$ to the plane of the surfaces (see Fig. 3). Those angles of incident light and viewing should minimize any gloss from the scale. If necessary, alter the angle of illumination to eliminate direct reflection of the incident light from the scale surface (see 12.4).

9.4 Compare the color of the stained portion of the test specimen to that of the closest numbered colored square of the Stain Scale. The rater may interpolate to the nearest $1/2$ grade in cases where the color depth of the stained specimen is between the steps of the scale (see 12.3).

10. Report

10.1 Report the numerical grade for stain resistance as determined in Section 9.

10.2 Report any deviation from the test procedure such as lighting conditions, angle of viewing, temperature, RH, etc.

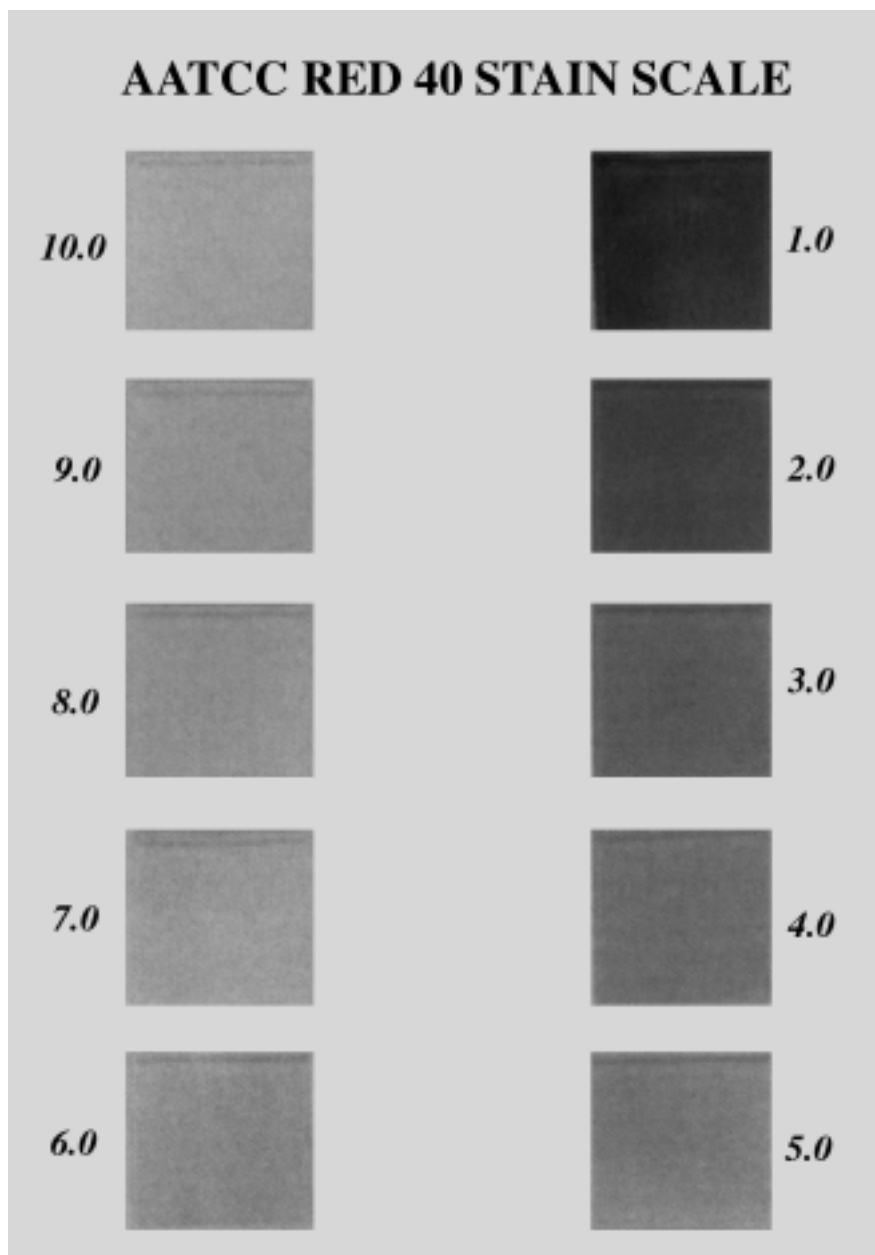
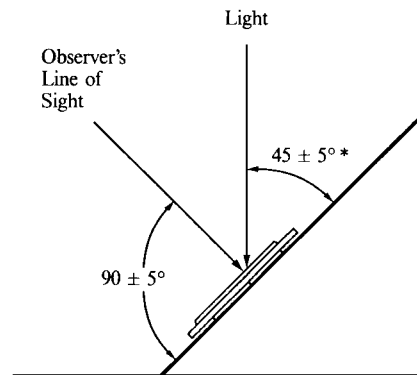

Fig. 2—Illustration of AATCC Red 40 stain scale.



*Adjust this angle to reduce light reflection (gloss) from the staining scale

Fig. 3—Illumination and viewing angles for rating samples.

11. Precision and Bias

11.1 Three interlaboratory tests were conducted in 1989 and 1990. The results of these tests indicate that the within-lab method precision standard deviation is 0.5 stain units. The within-lab 95% confidence interval is ± 1 . There were significant level differences between labs related to the application of the staining agent, so the total method precision sigma (including both the between and within-lab components) is 1. Therefore the between-lab

95% confidence interval is ± 2 .

11.2 No statement of bias can be made because the true stain value cannot be established by an independent method.

12. Notes

12.1 AATCC Red 40 Stain Scale is available from AATCC, P.O. Box 12215, Research Triangle Park NC 27709; tel: 919/549-8141; fax: 919/549-8933; e-mail: orders@aatcc.org.

12.2 The presence of vapors and fumes from a strong base; i.e., ammonia, etc., in the

test environment can increase the severity of staining.

12.3 Provision for a grade lower than 1 is provided for in Nomenclature for Subjective Rating Processes elsewhere in this TECHNICAL MANUAL. Any test specimen which has a change in color or contrast decidedly greater than a grade of 1 may be rated a 0.

12.4 Reflection of the incident light from the scale surface will make it difficult to properly evaluate the test specimen. The problem generally occurs when either the light source is too close to the scale or is too bright. These conditions should be avoided.

Speckiness of Colorant Dispersions: Evaluation of

Developed in 1992 by AATCC Committee RA87; reaffirmed 1993; editorially revised 1994, 2004; revised 1995, 1996 (with title change); editorially revised and reaffirmed 2001.

1. Purpose and Scope

1.1 Agglomerates in colorant dispersions may become apparent as specks on a continuously dyed (padded) or on a printed fabric, especially when pale and light shades are produced.

1.2 This test method is used to determine speckiness, primarily of disperse dye, vat dye and pigment dispersions.

2. Principle

2.1 A dispersion of a dye is filtered through a polyester/cotton blend fabric.

2.2 The degree of speckiness is assessed visually.

3. Terminology

3.1 **disperse dye**, n.—a nonionic dye which is sparingly soluble in water and which has substantivity, when properly dispersed, for polyester, polyamide and some other manufactured polymeric fibers.

3.2 **dispersion**, n.—in *textile wet processing*, a suspension of very fine particles in a liquid phase.

3.3 **pigment**, n.—a colorant in particulate form which is insoluble in the substrate, but which can be dispersed in the substrate to modify its color.

3.4 **speck**, n.—a small particle, such as an agglomerate in a liquid dispersion, or a very small spot of dark color on a dyed substrate.

3.5 **speckiness**, n.—in *textile dyeing and printing*, the quality or state of containing specks.

3.6 **vat dye**, n.—a water-insoluble dye, usually containing keto groups, which is normally applied to the fiber from an alkaline aqueous solution of the reduced enol (leuco) form which is subsequently oxidized in the fiber to the insoluble form.

4. Safety Precautions

NOTE: These safety precautions are for information purposes only. The precautions are ancillary to the testing procedures and are not intended to be all inclusive. It is the user's responsibility to use safe and proper techniques in handling materials in this test method. Manufac-

turers MUST be consulted for specific details such as material safety data sheets and other manufacturer's recommendations. All OSHA standards and rules must also be consulted and followed.

4.1 Good laboratory practices should be followed. Wear safety glasses in all laboratory areas.

4.2 All chemicals should be handled with care.

4.3 Use heat resistant gloves when working at hot air ovens and thermofixation devices.

4.4 Exposure to chemicals used in this procedure must be controlled at or below levels set by governmental authorities (e.g., Occupational Safety and Health Administration's [OSHA] permissible exposure limits [PEL] as found in 29 CFR 1910.1000 of January 1, 1989). In addition, the American Conference of Governmental Industrial Hygienists (ACGIH) Threshold Limit Values (TLVs) comprised of time weighted averages (TLV-TWA), short term exposure limits (TLV-STEL) and ceiling limits (TLV-C) are recommended as a general guide for air contaminant exposure which should be met (see 12.1).

5. Apparatus and Materials

5.1 Filter cloth: 65/35 polyester/cotton, bleached woven broadcloth (shirting weight), approx. 240 × 240 mm square (see 12.2). A fabric of similar construction and of varying blend ratios may be used, but it must then be stated in the report.

5.2 Funnel, Buchner, polypropylene, 110 mm diameter (see 12.3). Cut out the perforated bottom smoothly and even with the rim using a knife or other suitable implement. Both parts are used in the test.

5.3 Filtering flask, heavy wall with side tabulation, 2 L.

5.4 Rubber stopper, 1 hole, to fit the filtering flask.

5.5 Stirrer, small propeller type, diameter approx. 20 mm, speed up to 2,200 rpm.

5.6 Dishes, evaporating, glass or porcelain, 1 L (approx. 150 mm diameter), three, for testing vat dyes.

5.7 Ovens.

5.7.1 Drying, without air circulation.

5.7.2 Thermofixation.

6. Reagents (only for testing vat dyes)

6.1 Sodium hydroxide (NaOH) (30%).

6.2 Sodium hydrosulfite conc. powder ($\text{Na}_2\text{S}_2\text{O}_4$).

6.3 Hydrogen peroxide (H_2O_2) (30%).

6.4 Acetic acid (CH_3COOH) (80%).

7. Preparation of Liquid Dispersions for Sampling

7.1 On prolonged storage, liquid dispersions tend to settle and may develop a more or less tacky sediment. It is imperative to ensure complete homogeneity of the dispersion prior to testing. Thoroughly mix dispersions in drums using a mechanical mixing device, such as a propeller stirrer or homogenizer. The liquid must be smooth and free of sediment and lumps before removing a sample for testing. Thoroughly shake laboratory samples to ensure that all dried material adhering to the cover and sides of the container is re-incorporated into the liquid. Then remove the cover and stir the sample either mechanically or by hand until all sediment and/or lumps are completely redispersed. Replace the cover and again shake the sample to ensure complete homogeneity. Test the sample immediately after homogenization. When storing the sample for future use, thoroughly clean the lid and the container lip prior to closure.

8. Procedure

8.1 Identify the filter cloth with the experiment or sample number in one of the corners and ensure that it is free of extraneous specks.

8.2 Clean and dry the funnel. Prepare the funnel assembly by placing the top part of the funnel upside down on a clean surface and drape the fabric over it as flat as possible with the identification mark facing down towards the surface. The side of the fabric with the identification will then be on top during filtration and is used for subsequent evaluation (see 9.1). Snap and press the bottom half of the funnel to the top half, causing the fabric to become a tight, smooth filter in the funnel.

8.3 Place the assembled funnel straight on the filtering flask using the rubber stopper to ensure that the funnel remains upright (and the filter fabric horizontal) during filtration and rinsing.

8.4 Weigh 7.5 ± 0.075 g of 100% powder or 15.0 ± 0.15 g of 50% liquid (or an equivalent weight of other concentrations) in a weighing cup and transfer to a 400 mL graduated beaker containing approx. 200 mL deionized or distilled water at room temperature. Rinse the weighing cup with water from a spray bottle.

8.5 With powder and granular forms:

stir 3 min with the propeller of the stirrer in the center and just above the container bottom. Adjust the stirrer and speed to create a vortex terminating at the top of the propeller.

8.6 With liquid forms: stir as in 8.5 except for 30 s.

8.7 After stirring, transfer the dispersion to the 1 L beaker. Rinse the 400 mL beaker with 200 mL deionized or distilled water at room temperature and pour the rinse water into the 1 L beaker. Dilute the dispersion further to 800 mL.

8.8 Pre-wet the fabric in the filter with 200 mL water.

8.9 Stir the dispersion in the beaker for approx. 30 s and pour it into the funnel.

8.10 Rinse the beaker with 200 mL water and pour it into the funnel.

8.11 Rinse the funnel with an additional 200 mL water and let stand for about 1 min until dripping has completely stopped.

8.12 Carefully remove the filter cloth from the funnel and place it on a blotting paper to remove excess water.

8.13 For disperse dyes:

8.13.1 Dry the fabric in an oven without air circulation at $80 \pm 5^\circ\text{C}$.

8.13.2 Thermoflex for 60 s at $210\text{--}220^\circ\text{C}$.

8.14 For vat dyes proceed as follows:

8.14.1 Prepare 400 mL of a fresh reducing solution in an evaporating dish (see 12.4) at $60\text{--}70^\circ\text{C}$ containing 30 mL/L sodium hydroxide, 30%, and 20 g/L sodium hydrosulfite conc. powder.

8.14.2 Fully immerse the filter cloth in

the reducing solution in the evaporating dish for 5 min. Do not move the cloth during this time.

8.14.3 Immerse the filter cloth for 1 min without agitation in an evaporating dish containing deionized or distilled water at $15\text{--}25^\circ\text{C}$.

8.14.4 Prepare 100 mL of an oxidizing solution in an evaporating dish at $40\text{--}50^\circ\text{C}$ containing 10 mL/L hydrogen peroxide, 30%.

8.14.5 Fully immerse the filter cloth in the oxidizing solution in the evaporating dish for 2 min. Do not move the cloth during this time.

8.14.6 Neutralize the filter cloth for 2 min at $15\text{--}25^\circ\text{C}$ with 200 mL/L acetic acid, 80%, in a 400 mL beaker.

8.14.7 Rinse for approx. 30 s in cold running water.

8.14.8 Dry the fabric in an oven at $80 \pm 5^\circ\text{C}$.

8.15 For pigments:

8.15.1 Dry the fabric in an oven without air circulation at $80 \pm 5^\circ\text{C}$.

9. Evaluation

9.1 Visually examine the fabric for specks on the side with the identification mark. Count individual specks. Base the acceptability on user requirements; for example, acceptable, marginal, unacceptable.

10. Report

10.1 Report the dyestuff tested and weight used, the number of specks and

the speckiness rating.

11. Precision and Bias

11.1 *Precision.* Precision for this test method has not been established. Until a precision statement is generated for this method, use standard statistical techniques in making any comparisons of test results for either comparisons of test results for either *within-laboratory* or *between-laboratory* averages.

11.2 *Bias.* Speckiness of colorant dispersions can be defined only in terms of a test method. There is no independent method for determining the true value. As a means of estimating this property, the method has no known bias.

12. Notes

12.1 Available from Publications Office, ACGIH, Kemper Woods Center, 1330 Kemper Meadow Dr., Cincinnati OH 45240; tel: 513/742-2020.

12.2 Available as Style 7409 from Testfabrics Inc., P.O. Box 26, 415 Delaware St., W. Pittston PA 18643; tel: 570/603-0432; fax: 570/603-0433; e-mail: testfabric@aol.com.

12.3 Available as Cat. #10-362E from Fisher Scientific, 50 Fadem Rd., Springfield NJ 07081; tel: 201/467-6400. May also be available from other laboratory equipment suppliers.

12.4 The reason for using evaporating dishes for the reduction and oxidation of vat dyes is to keep the fabric flat and without agitation. This prevents any specks from dissolving and leveling.

Barré: Visual Assessment and Grading

Developed in 1992 by AATCC Committee RR97; revised 1993, 1994; editorially revised 1995, 1997; reaffirmed 1999, 2004.

1. Purpose and Scope

1.1 Barré is the optical result of physical or dye differences in the yarns, geometric differences in the fabric structure or any combination of these differences. This test method provides a standard procedure for evaluating barré intensity and for describing pattern characteristics based on visual comparison to a Uniformity Reference Scale and description of the barré pattern using a standard terminology. It can be used with knitted fabrics, woven fabrics and garments. The standard terminology is particularly useful in oral and written communications.

2. Principle

2.1 Continuous lengths of fabric on an inspection frame, individual garments, or samples of fabric are observed under specified conditions, rated for barré intensity, assessed for barré pattern characteristics and assigned an overall grade. Included in the grade are the following items:

2.1.1 An estimate of barré intensity on a 9 to 1 Uniformity Reference Scale as shown in Fig. 1 [from no barré (9) to severe barré (1)] (see 11.1).

2.1.2 A description of the barré pattern as "simple," "complex" or "banded" as defined in Section 3, Terminology.

2.1.3 A description of those yarns that contrast with the normal population such as "light," "bulky," etc. as defined in Section 3.

2.1.4 An estimate of the percentage of yarns within each pattern repeat containing the barré pattern.

2.2 Fabrics are examined but not rated for barré while they are moving over an inspection frame which is positioned at a $45 \pm 5^\circ$ angle to the horizontal (see Fig. 2 and 7.1.1-7.1.2) or as agreed upon by buyer and seller.

2.3 Garments are examined for barré while hanging vertically under overhead lighting (see Fig. 3 and 7.2.1-7.2.8) or as agreed upon by buyer and seller.

2.4 Barré intensity is rated by visual comparison with the Uniformity Reference Scale.

3. Terminology

3.1 Definitions

3.1.1 **barré**, n.—an unintentional, repetitive visual pattern of continuous bars and stripes usually parallel to the filling of woven fabric or the courses of circular knit fabric.

NOTE: The term barré is sometimes used as a synonym for "filling bands." Barré in warp knit fabrics is most often referred to as "warp streaks."

3.2 Descriptive Terms and Code Letters for Barré Patterns

3.2.1 **simple**, adj.—consisting of not more than two contrasting yarns—light, dark; lean, bulky; intermittent, uniform; etc.—spaced at regular intervals. (A)

3.2.2 **banded**, adj.—a simple pattern in which the contrasting yarns alternate in equal width intervals. (B)

3.2.3 **complex**, adj.—consisting of two or more interspersed simple patterns. (C)

3.3 Descriptive Terms and Code Letters for Yarn Appearance

3.3.1 **single yarn**, n.—one yarn that contrasts with adjacent yarns. (D)

3.3.2 **multiple yarns**, n.—two or more yarns that contrast with adjacent yarns. (E)

3.3.3 **lean yarn**, n.—a yarn having a smaller diameter than the normal population. (F)

3.3.4 **bulky yarn**, n.—a yarn having a greater diameter than the normal population. (G)

3.3.5 **light yarn**, n.—a yarn that appears to be lighter than the normal population. (H)

3.3.6 **dark yarn**, n.—a yarn that appears to be darker than the normal population. (I)

3.3.7 **intermittent yarn**, n.—a yarn that is nonuniform in color intensity along its length, appearing as light and dark sequences. (J)

3.3.8 **flashes**, n.—a type of intermittent yarn in which the lengths of the light/dark sequences are usually 2.5 cm (1.0 in.) or less. (K)

4. Safety Precautions

NOTE: These safety precautions are for information purposes only. The precautions are ancillary to the testing procedures and are not intended to be all inclusive. It is the user's responsibility to use safe and proper techniques in handling materials in this test method. Manufacturers MUST be consulted for specific details such as material safety data sheets and other manufacturer's recommendations. All OSHA standards and rules must also be consulted and followed.

4.1 Good laboratory practices should be followed.

4.2 Hands should not come in contact with the inspection frame while the fabric is in motion.

4.3 Inspection frames MUST be turned off while fabric samples are being graded with the Uniformity Reference Scale.

5. Apparatus and Materials

5.1 Uniformity Reference Scale (see 11.1).

5.2 Inspection frame.

5.3 An evaluation area arranged as shown in Fig. 2 using two 8-ft. Type F96 CW (cool white) preheat rapid-start fluorescent lamps (without baffle or glass) and a white enamel reflector (without baffle or glass) having a known lighting intensity of no less than 100 lx.

5.4 An evaluation area in an otherwise darkened room using the overhead lighting arrangement as shown in Fig. 3.

5.4.1 Lighting equipment for viewing test specimens with two 8-ft Type F96 CW (cool white) preheat rapid-start fluorescent lamps (without baffle or glass), a white enamel reflector (without baffle or glass) and a general type spring loaded swatch mount. Fabricate using 22 gauge sheet metal. A quarter-inch plywood mounting board having outside dimensions of 183×122 cm (6×4 ft), painted gray to match Grade No. 2 on the AATCC Gray Scale for Staining.

6. Test Specimens

6.1 Rate a minimum of three specimens of each textile item under evaluation and assign an average barré grade.

6.1.1 For fabrics, the full length and width of an entire roll constitutes one specimen. Where fewer than three rolls are available, three or more approximately equal but separate areas of the specimen length available must be marked for identification and rated. Each separate area constitutes a specimen.

6.1.2 For garments, one garment constitutes a specimen.

7. Procedure

7.1 Length of fabric.

7.1.1 View a single layer of the moving fabric on an inspection frame which is positioned at a 0.79 ± 0.09 rad ($45 \pm 5^\circ$) angle to the observer. The observer should be positioned approximately 1 m (1 yd) from the bottom edge of the inspection frame (see Fig. 2).

7.1.2 Three or more trained observers

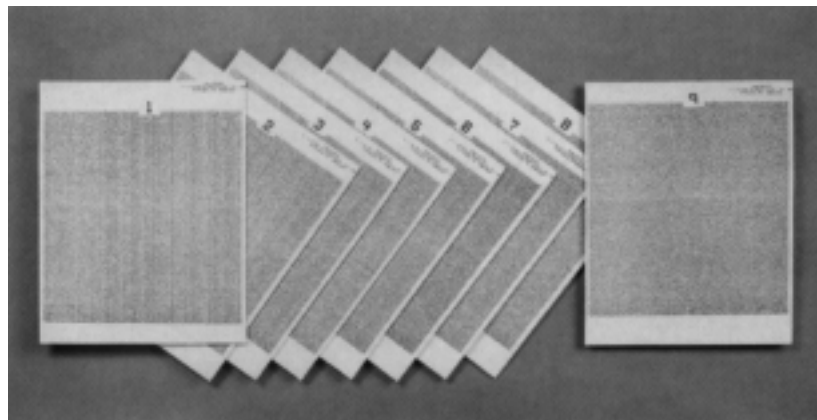

Fig. 1A—Illustration of Uniformity Reference Scale.

USE OF THE SYSTEM

This description consists of four elements the combination of which allows barré to be described in as much detail as needed. These are:

- 1) An estimate of barré intensity on a 9 to 1 scale,
- 2) A description of the barré pattern such as “simple,” “complex,” etc.,
- 3) An estimate of the percentage of yarns within each pattern repeat that are involved in the barré, and
- 4) A description of the yarns that contrast with the normal population such as “light,” “bulky,” etc.

Examples

1. 3, C, 10%, F, I.
A 3-intensity, complex pattern, in which 10% of the yarns appear to be either lean (low in bulk) or dark dyeing.
2. 4, B, 50%, H.
A 4-intensity banded pattern, in which 50% of the yarns are grouped together and appear lighter than the standard shade.
3. 4, A, 2%, D, I.
A 4-intensity, simple pattern of one dark end.
4. 4, C, 20%, E, F, K.
A 4-intensity pattern consisting of low bulk ends and ends containing dark and light sequences less than 2.5 cm long.

TERMINOLOGY

Definition for Barré

barré, n.—an unintentional, repetitive visual

pattern of continuous bars or stripes usually parallel to the filling of woven fabric or the courses of circular knit fabric.

NOTE: The term “barré” is sometimes used as a synonym for filling bands. Barré in warp knit fabrics is most often referred to as “warp streaks.”

Descriptive Terms for Barré Patterns

- A. **simple**—consisting of not more than two contrasting yarns—light, dark; lean, bulky; intermittent, uniform; etc.—spaced at regular intervals.
- B. **banded**—a simple pattern in which the contrasting yarns alternate in equal-width intervals.
- C. **complex**—consisting of two or more interspersed simple patterns.

Descriptive Terms for Yarn Appearance

- D. **single yarn**—one yarn that contrasts with adjacent yarns.
- E. **multiple yarns**—two or more yarns that contrast with adjacent yarns.
- F. **lean yarn**—a yarn having a smaller diameter than the normal population.
- G. **bulky yarn**—a yarn having a greater diameter than the normal population.
- H. **light yarn**—a yarn that appears lighter than the normal population
- I. **dark yarn**—a yarn that appears darker than the normal population
- J. **intermittent yarn**—a yarn that is non-uniform in color intensity along its length, appearing as light and dark sequences.
- K. **flashes**—a type of intermittent yarn, in which the lengths of the light/dark sequences are usually 2.5 cm or less.

Fig. 1B—Terminology for Uniformity Reference Scale.

shall rate each specimen.

7.1.3 Base the grade on the full fabric width.

7.1.4 Position the center of the light source 60-90 cm (2-3 ft) from the top edge of the inspection frame parallel to the fabric surface and above and in front of the viewer such that light rays are at a 90° angle to the fabric (see Fig. 2).

7.1.5 Assess the fabric using reflected light (see 11.2).

7.1.6 Stop the inspection frame and place the Uniformity Reference Scale on the inspection frame adjacent to the fabric with the long dimension of the scale panel parallel to the fabric length.

7.1.7 Rate the fabric and assign the appropriate grade as specified in Section 8.

7.2 Garments.

7.2.1 Designate those garment components which are important to the item’s appearance for barré.

7.2.2 Three or more trained observers shall rate each component independently.

7.2.3 Display the garments in the lighted evaluation area. Mount each item on the viewing board so that the area or component to be rated is approximately 150 cm (5 ft) from the floor as illustrated in Fig. 3 with the Uniformity Reference Scale placed adjacent to the item being rated with the long dimension of the scale panel parallel to the item length.

7.2.4 The overhead fluorescent light should be the only light source for the viewing board; turn off all other lights in the room.

7.2.5 Light reflected from the walls near the viewing board can interfere with the rating results. Therefore, the walls should be painted black or blackout curtains should be mounted on either side of the viewing board to eliminate reflection.

7.2.6 The observer shall stand directly in front of the test item 120 cm (4 ft) away from the board. Normal variations in the height of the observer above and below the arbitrary 150 cm (5 ft) eye level have no significant effect on the grade given.

7.2.7 Rate the individual components of the item for barré and assign them the appropriate grades as specified in Section 8.

7.2.8 Similarly, the observer independently rates each additional specimen. The other two observers proceed in the same manner, assigning grades independently.

7.3 Fabric samples.

7.3.1 Lay the fabric sample on a flat table using the largest fabric dimensions possible with that side of the fabric visible which the customer will use on the garment face.

7.3.2 Illuminate the fabric with fluorescent light at an intensity of no less than 100 lx (see 5.3).

7.3.3 Lay one or more uniformity scale

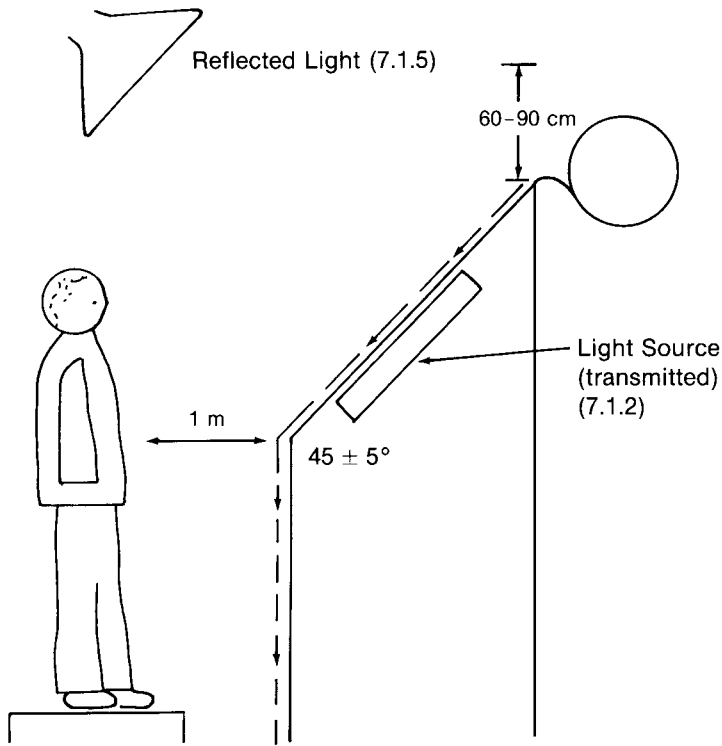

Fig. 2—Arrangement for viewing continuous lengths of fabric.

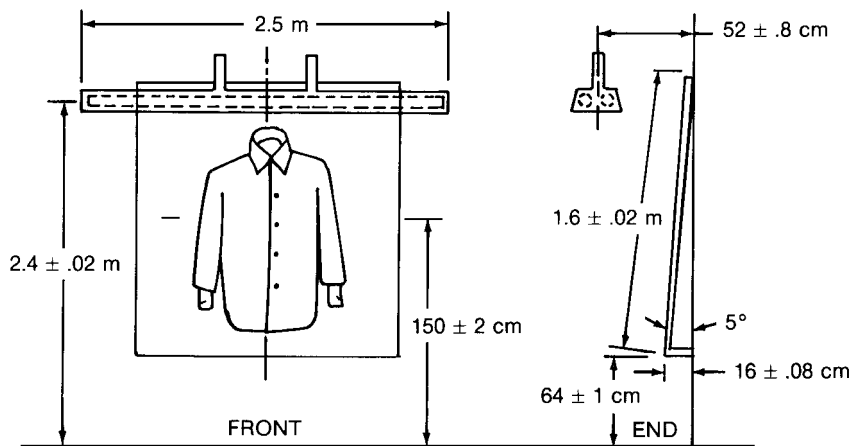

Fig 3—Arrangement for viewing garments or short lengths of fabric.

panels on or beside the fabric with the long dimension of the panel parallel to the fabric stripiness.

7.3.4 The observer shall not be in one fixed position, but be free to move around the table and away from it as necessary so as to view the fabric at various angles.

7.3.5 Rate the fabric sample at the most critical viewing angle and assign grades as specified in Section 8.

7.3.6 If more than one observer is available, repeat the process, and report the results as specified in Section 8.

8. Rating

8.1 Assign the number of the Uniformity Reference Scale that most nearly matches the barré intensity of the test specimen or assign a number midway between those whole-number standards if

the barré of the test specimen warrants it.

8.2 Assign A, B or C to describe the barré pattern.

8.3 Assign D, E, F, G, H, I, J and/or K to describe yarn appearance. Include all yarn appearances observed.

8.4 Assign a percentage estimate as to the overall coverage of barré in the test specimen.

8.5 Example—A grade of 3, C, 10%, F, I shows this fabric to have an intensity rating of 3 with a complex pattern (C), in which 10% of the yarns appear to be either lean (F) (low in bulk) or dark dyeing (I).

9. Report

9.1 Report the average numerical grade to the nearest 0.1 and, if different, letter grades for all specimens for all observers.

9.2 Report whether lengths of fabric, garments or fabric samples were rated.

10. Precision and Bias

10.1 *Precision.* An interlaboratory test was conducted in 1991-1992 to establish precision of the test method. Sixteen raters from Laboratory A and 15 raters from Laboratory B were tested using ten uniformity reference panels plus a replicate and five fabric panels in a four-by-four balanced lattice design with appropriate lighting. Five Laboratory A raters performed ratings at Laboratory B and five Laboratory B raters performed ratings at Laboratory A. Eight Laboratory A raters then re-rated at Laboratory A. There was no significant location or time effect. For the 10 to 1 Uniformity Reference Scale, the standard deviation for one reading by one rater calculated to be 0.73 (see 11.3).

10.2 *Bias.* Within the limitations of this test method, the test method has no known bias.

11. Notes

11.1 Available from AATCC, P.O. Box 12215, Research Triangle Park NC 27709; tel: 919/549-8141; fax: 919/549-8933; e-mail: orders@aatcc.org. This scale is copyrighted by the DuPont Co. and is based on U.S. Patent 4984181, August 28, 1990, Method of Simulating By Computer the Appearance Properties of a Fabric, Harvey L. Kliman and Royden H. Pike, assignors to E.I. du Pont Company, Wilmington, DE.

11.2 Should physical barré be suspected, view with transmitted light instead of reflected light.

11.3 For the purpose of this test method, the number 10 reference panel is not used.

Skewness Change in Fabric and Garment Twist Resulting from Automatic Home Laundering

Developed in 1994 by AATCC Committee RA42; revised 1995, 2004; reaffirmed 1996; editorially revised and reaffirmed 2001; editorially revised 2005.

1. Purpose and Scope

1.1 This test method determines change in skewness in woven and knitted fabrics or twist in garments when subjected to repeated automatic laundering procedures commonly used in the home. Washing and drying procedures used for shrinkage tests and other home laundering tests are specified for this method.

1.2 For some fabrics the degree of twist of fabric in garments is not solely dependent on its behavior in the unsewn state; it also may be dependent on the manner of garment assembly.

2. Principle

2.1 Change in skewness in fabric or twist in garment specimens resulting from procedures typical of home laundering practices is measured using bench marks applied to the specimens before laundering.

3. Terminology

3.1 **garment twist**, *n.*—a rotation, usually lateral, between different panels of a garment resulting from the release of latent stresses during laundering of the woven or knitted fabric forming the garment. Twist may also be referred to as torque or spirality.

3.2 **laundering**, *n.*—of textile materials, a process intended to remove soils and/or stains by treatment (washing) with an aqueous detergent solution and normally including rinsing, extraction and drying.

3.3 **skewness**, *n.*—a fabric condition resulting when filling yarns or knitted courses are angularly displaced from a line perpendicular to the edge or side of the fabric (see ASTM Terminology D 123-92).

4. Safety Precautions

NOTE: These safety precautions are for information purposes only. The precautions are ancillary to the testing procedures and are not intended to be all inclusive. It is the user's responsibility to use safe and proper techniques in handling materials in this test method. Manufac-

turers MUST be consulted for specific details such as material safety data sheets and other manufacturer's recommendations. All OSHA standards and rules must also be consulted and followed.

4.1 Good laboratory practices should be followed. Wear safety glasses in all laboratory areas.

4.2 The 1993 AATCC Standard Reference Detergent may cause irritation. Care should be taken to prevent exposure to skin and eyes.

4.3 Manufacturer's safety recommendations should be followed when operating laboratory testing equipment.

5. Apparatus and Materials

5.1 Indelible ink marking pen (see 12.6).

5.2 Right triangle, L-square (see 12.7), or marking template (see 12.8).

5.3 Tape or rule marked in millimeters, tenths of an inch or smaller increments.

5.4 Conditioning/drying racks with pull-out screens or perforated shelves (see 12.3).

5.5 Automatic washing machine (see 12.1).

5.6 1993 AATCC Standard Reference Detergent (see 12.4 and 12.14).

5.7 Scale with at least 5 kg (10 lb) capacity.

5.8 Ballast of $920 \times 920 \pm 30$ mm ($36 \times 36 \pm 1$ in.) hemmed pieces of bleached cotton sheeting (Wash load ballast type 1) or 50/50 polyester/cotton bleached mercerized plain weave (Wash load ballast type 3) (see 12.5 and 12.14).

5.9 Automatic tumble dryer (see 12.2).

5.10 Facilities for drip drying and line drying.

5.11 Digital Imaging System (see 12.15).

6. Test Specimens

6.1 Sampling and Preparation.

6.1.1 Prior to marking, pre-condition and then condition test specimens as directed in ASTM Practice D 1776, Standard Practice for Conditioning and Testing Textiles. Condition each specimen for at least 4 h in an atmosphere of $21 \pm 1^\circ\text{C}$ ($70 \pm 2^\circ\text{F}$) and $65 \pm 2\%$ RH by laying each test specimen separately on a screen or perforated shelf of a conditioning rack. If garments would normally be hung on a hanger, they should be conditioned on a hanger.

6.1.2 Fabrics or garments that are distorted in their unlaundered state due to

faulty finishing of the fabric or faulty assembly of garments may give deceptive results when laundered by any procedure. In such cases, it is recommended that specimens not be used, or if used, the results be considered as indicative of these specimens only.

6.2 Test Specimens from Fabric Samples.

6.2.1 Test three specimens of each sample to **increase** precision of the average.

6.2.2 Where possible, cut specimens from different areas of the fabric so that each specimen will contain different groups of lengthwise and widthwise yarns. Identify fabric face; mark lengthwise direction on each specimen.

6.2.3 If it is of interest to determine whether the direction of the change in skewness is different from one side of the fabric to the other, prepare three sets of specimens from each area of interest. Identify area from which each set of specimens was taken; i.e., left-side, center or right-side.

6.2.4 Test specimens prepared for AATCC Method 124, Appearance of Fabrics after Repeated Home Laundering, and AATCC Method 135, Dimensional Changes of Fabrics after Home Laundering, may be used for this test method when marking by Method 1 (see 12.9).

6.3 Test Specimens from Garment Samples.

6.3.1 Test three garment specimens or a total of three areas of two garments to **increase** precision of the average. Use the largest panels in the garments.

6.3.2 Test specimens prepared for AATCC Method 143, Appearance of Apparel and Other Textile End Products after Repeated Home Laundering, and AATCC Method 150, Dimensional Changes of Garments after Home Laundering, may be used for this test method when marking by Method 1.

6.4 Marking of Specimens.

6.4.1 Marking Method 1 (see 12.10).

6.4.1.1 On each 380×380 mm (15 × 15 in.) fabric test specimen or garment panel, mark two 250 mm (10 in.) pairs of bench marks parallel to the length of the specimen and two 250 mm (10 in.) pairs of bench marks perpendicular to the length of the specimen. Draw a line through each of the four sets of adjacent bench marks so that a square is formed. Label corners as A, B, C and D in clockwise direction starting with lower left

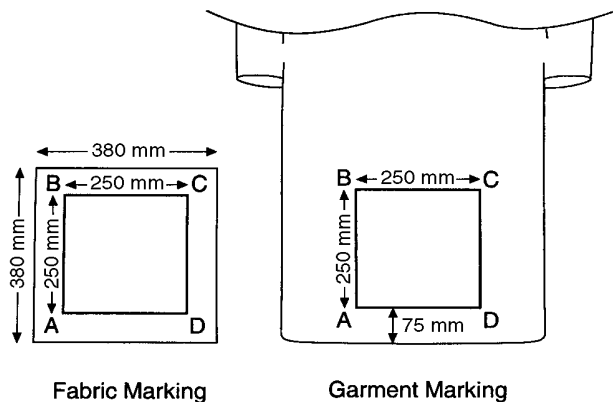

Fig. 1—Method 1: square marking.

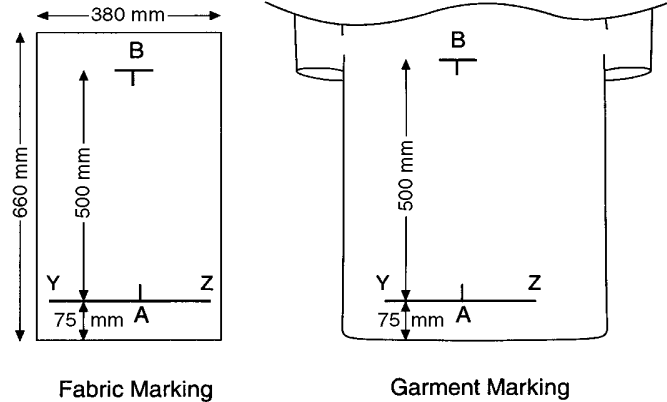

Fig. 2—Method 2: inverted T marking.

corner (see Fig. 1). Any alternate size specimens and bench marks used must be indicated in report (see 12.11 and 12.12).

6.4.1.2 Flat and circular knit fabrics: Tubular finished knit fabric samples representing goods used in the tubular state; i.e., underwear, sweat shirts, polo shirts, etc., are to be tested in the tubular state. Tubular finished knit fabric samples representing goods used in the slit open width state; i.e., for dresses, slacks, suits, etc., are to be slit and handled flat.

6.4.2 Marking Method 2.

6.4.2.1 On a 380 × 660 mm (15 × 26 in.) fabric specimen or garment panel, use a suitable marking device to draw reference line YZ across the width of the specimen panel (see Fig. 2). Line YZ should be approximately 75 mm (3 in.) above the bottom edge (or hem of garment). If the bottom edge or hem is not straight, draw the reference line perpendicular to the vertical axis of symmetry of the specimen. Place bench mark A perpendicular to and midway on Line YZ. Place one leg of a right angle marking device along Line YZ so that the second leg is on a perpendicular upward from Point A. Draw a bench mark parallel to Line YZ 500 mm (20 in.) directly above Point A. Draw another bench mark 480 mm (19 in.) from Point A perpendicular to Line YZ to intersect previous bench mark. Label the intersection of the bench marks as Point B. If the specimen size is insufficient to mark a 500 mm (20 in.) length, mark the longest available length which is at least 75 mm (3 in.) below the upper edge of the test specimen. Any alternate size specimen or dimensions of bench marks must be indicated in the report.

7. Procedure

7.1 Tables I, II and III summarize alternative washing and drying conditions and settings.

7.2 Washing.

7.2.1 Use specified water level and fill

Table I—Alternative Washing and Drying Conditions

Machine Cycle	Washing Temperatures	Drying Procedures
(1) Normal/Cotton Sturdy	(II) 27 ± 3°C (80 ± 5°F)	(A) Tumble:
(2) Delicate	(III) 41 ± 3°C (105 ± 5°F)	i. Cotton Sturdy
(3) Permanent Press	(IV) 49 ± 3°C (120 ± 5°F)	ii. Delicate
	(V) 60 ± 3°C (140 ± 5°F)	iii. Permanent Press
		(B) Line
		(C) Drip
		(D) Screen

Table II—Washing Machine Setting Conditions without Load

Cycle ¹	X	Y	Z
Water Level	18 ± 1 gal	18 ± 1 gal	18 ± 1 gal
Agitator Speed	179 ± 2 spm ²	119 ± 2 spm	119 ± 2 spm
Washing Time	12 min	8 min	10 min
Spin Speed	645 ± 15 rpm ³	645 ± 15 rpm	430 ± 15 rpm
Final Spin Cycle	6 min	6 min	4 min

¹ Cycle names vary with machine model. "X" generally corresponds to "Heavy Duty." "Y" generally corresponds to "Delicate." "Z" generally corresponds to "Permanent Press."

² spm = strokes per minute.

³ rpm = revolutions per minute.

Table III—Tumble Dry Conditions

Designation	Cycle	Maximum Exhaust Stack Temperature with Loaded Dryer
a	Normal or Permanent Press	67 ± 6°C (154 ± 10°F) after 1983 [65 ± 6°C (150 ± 10°F) before 1983]
b	Delicate, Synthetic, Low	< 62°C (144°F) after 1983 [< 60°C (140°F) before 1983]
Cool down time	Normal and Delicate Permanent Press [All]	5 min 10 min 10 min after 1983]

machine, the selected water temperature for the washing cycle and a rinse temperature of less than 29°C (85°F). If this rinse temperature is not attainable, record actual rinse temperature.

7.2.2 Add 66 ± 1 g of 1993 AATCC Standard Reference Detergent. In soft water areas the weight may be reduced to

avoid excessive sudsing.

7.2.3 Add test specimens and enough ballast to make a 1.8 ± 0.1 kg (4.00 ± 0.25 lb) load. A 3.6 ± 0.1 kg (8.00 ± 0.25 lb) load may be used (see 12.13). Set the washer for the selected washing cycle and time (see Tables I and II).

7.2.4 For specimens to be dried by Pro-

cedures A, B or D, allow washing to proceed automatically through the final spin cycle. Remove the test specimens immediately after the final spin cycle, separate tangled pieces, taking care to minimize distortion, and dry by Procedures A, B or D (see Table I).

7.2.5 For specimens to be dried by Procedure C, Drip Dry, remove the specimens from the washer soaking wet before the water begins to drain from the final rinse cycle.

7.3 Drying.

7.3.1 (A) Tumble Dry. Place the washed load (test specimens and ballast pieces) in the tumble dryer and set the temperature control to generate the correct exhaust temperature as specified in Table III. For fibers that are heat sensitive, lower temperatures consistent with fiber producer's recommendations are required and must be reported. Operate the dryer until the total load is dry. Remove the load immediately after machine stops, handling to minimize wrinkling prior to conditioning.

7.3.1.1 Spread the fabric samples flat after tumble drying.

7.3.1.2 Depending on the type of garment either spread flat or hang from suitable hanger.

7.3.2 (B) Line Dry.

7.3.2.1 Hang each fabric specimen by two corners with the length in the vertical direction.

7.3.2.2 Hang each garment on an appropriate hanger straightening and smoothing facings, seams, etc. Hang pants and skirts by waistband at side seams.

7.3.2.3 Allow the test specimen to hang in still air at room temperature until dry.

7.3.3 (C) Drip Dry.

7.3.3.1 Hang each dripping wet fabric specimen by two corners, with the length in the vertical direction.

7.3.3.2 Hang dripping wet pants and skirts by waistband at side seams. Hang other dripping wet garment specimens on an appropriately sized hanger.

7.3.3.3 Allow the test specimen to hang in still air at room temperature until dry.

7.3.4 (D) Screen Dry.

7.3.4.1 Spread each specimen, fabric or garment, on a horizontal screen or perforated surface, removing wrinkles but not distorting or stretching it.

7.3.4.2 Allow specimen to dry in still air at room temperature.

7.3.5 Repeat the selected washing and drying cycle four more times or to agreed number of cycles.

7.4 Conditioning of Specimens.

7.4.1 After the completed washing and drying interval, pre-condition and then condition the specimens for at least 4 h by laying each specimen separately on the screen or perforated shelf of a conditioning rack in an atmosphere of $21 \pm 1^\circ\text{C}$

($70 \pm 2^\circ\text{F}$) and $65 \pm 2\%$ RH (see ASTM Practice D 1776).

7.4.1.1 If garments would normally be hung on a hanger, they should be conditioned on a hanger.

8. Measurement

8.1 After conditioning, lay each test specimen without tension on a flat, smooth horizontal surface.

8.1.1 The wrinkles in most fabrics flatten sufficiently under pressure of a measuring instrument at the time of measurement not to cause measurement error.

8.1.2 Calculation Option 1 or 2 can be used for marking Method 1. Calculation Option 3 should be used for marking Method 2.

8.2 Measurement of square markings using calculation Option 1.

8.2.1 Measure and record the length of the diagonal line AC and diagonal line BD to the nearest millimeter, or tenth of an inch or smaller increment (see Fig. 3a).

8.3 Measurement of square markings using calculation Option 2.

8.3.1 Extend line AD in each direction

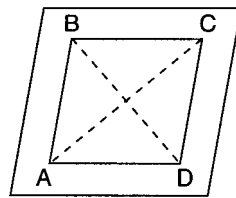

a. Diagonal lines for Option 1

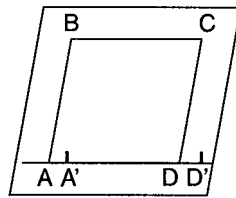

b. Offset marks for Option 2

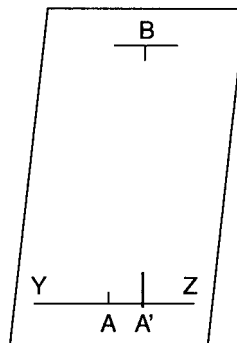

c. Offset mark for Option 3

Fig. 3—Marking specimen for specific calculation option.

across the width of the specimen. Place one leg of a right angle marking device along line AD so that the second leg is on a perpendicular downward from point B . Draw bench mark A' to intersect horizontal line AD . Next place one leg of marking device along line AD so that the second leg is on a perpendicular downward from point C . Draw bench mark D' to intersect horizontal line AD (see Fig. 3b). Measure and record the length of lines AA' , DD' , AB , and CD with a suitable tape or ruler to the nearest millimeter or tenth of an inch or smaller increment.

8.3.2 Where change in skewness has occurred, indicate whether the bottom of the parallelogram has shifted to the left or the right.

8.4 Measurement of inverted T markings using calculation Option 3.

8.4.1 Place one leg of a right angle marking device along Line YZ so that the second leg is on a perpendicular downward from point B . Draw a bench mark along the perpendicular on line YZ . The intersection of the bench mark and line YZ corresponds with point A' in Fig. 3c. Measure and record the length of lines AA' and AB with a suitable tape or ruler to the nearest millimeter or tenth of an inch or smaller increment.

8.4.2 Indicate whether point A has shifted to the left or right.

8.5 Points A' , for Options 2 and 3, plus D' , for Option 2, are used after five or an agreed upon number of washings. Points after subsequent washings should be indicated by numbers or other symbols to differentiate measurements.

9. Calculation and Interpretation

9.1 Calculation of Change in Skewness.

9.1.1 Option 1 (see Fig. 3a).

9.1.1.1 Calculate percent change in skewness to the nearest 0.1% as follows:

$$X = 100 \times [2 (AC - BD)/(AC + BD)]$$

where:

X = % change in skewness

9.1.1.2 A positive percent change indicates skewness to the left; a negative percent change indicates skewness to the right.

9.1.2 Option 2 (see Fig. 3b).

9.1.2.1 Calculate percent change in skewness to the nearest 0.1% as follows:

$$X = 100 \times [(AA' + DD')/(AB + CD)]$$

where:

X = % change in skewness

9.1.3 Option 3 (see Fig. 3c).

9.1.3.1 Calculate percent change in skewness to nearest 0.1% as follows:

$$X = 100 \times (AA'/AB)$$

where:

X = % change in skewness

9.1.4 The calculation of Option 1 is related on a mathematical basis to the calculations of Options 2 and 3. However, when comparing data between laboratories the same option should be used for calculations.

9.1.5 Average the results for any of the above measuring techniques.

9.1.6 If the test is used to establish the condition of the fabric across the width (see 6.2.3), calculate averages for each area separately.

9.2 Interpretation of Change in Skewness.

9.2.1 If the change in skewness for fabric or garment specimens after one washing and drying cycle is within a specification previously agreed on, continue until an agreed upon number of cycles have been completed.

9.2.2 If the change in skewness exceeds a specification previously agreed on, terminate the test.

10. Report

10.1 Report for each sample tested:

10.1.1 Percent change in skewness or garment twist.

10.1.2 Washing procedure (Arabic number and Roman numeral) and drying procedure (capital letter) from Table I, II and III; i.e., (1)IIIA(iii) means normal cycle, wash water at $41 \pm 3^\circ\text{C}$ ($105 \pm 5^\circ\text{F}$), tumble dry (permanent press). Also indicate size of load; i.e., 1.8 kg (4.0 lb) or 3.6 kg (8.0 lb).

10.1.3 Number of complete washing and drying cycles (see 9.2.1).

10.1.4 Direction of change in skewness or garment twist.

10.1.5 Alternate size specimens and/or bench marks if used.

11. Precision and Bias

11.1 Precision for this method has not

been established. Until a precision statement is generated, use standard statistical techniques in making any comparisons of test results for either *within-laboratory* or *between-laboratory* averages.

12. Notes

12.1 Contact AATCC, P.O. Box 12215, Research Triangle Park NC 27709; tel: 919/549-8141; fax: 919/549-8933; e-mail: orders@aatcc.org, for model number(s) and source(s) of current approved washer(s). Any other washer which is known to give comparable results can be used. Washing machine conditions given in Table II represent the actual speeds and times available on the current specified model(s). Other washers may vary in one or more of these settings.

12.2 Contact AATCC, P.O. Box 12215, Research Triangle Park NC 27709; tel: 919/549-8141; fax: 919/549-8933; e-mail: orders@aatcc.org, for model number(s) and source(s) of current approved dryer(s). Any other dryer which is known to give comparable results can be used. Dryer machine conditions given in Table III represent the actual temperatures and cool-down times available on the current specified model(s). Other dryers may vary in one or more of these settings.

12.3 Screen or perforated conditioning/drying racks available from Somers Sheet Metal Inc., 5590 N. Church St., Greensboro NC 27405; tel: 336/643-3477; fax: 336/643-7443. Rack drawings available from AATCC, P.O. Box 12215, Research Triangle Park NC 27709; tel: 919/549-8141; fax: 919/549-8933; e-mail: orders@aatcc.org.

12.4 The 1993 AATCC Standard Reference Detergent is available from AATCC, P.O. Box 12215, Research Triangle Park NC 27709; tel: 919/549-8141; fax: 919/549-8933; e-mail: orders@aatcc.org.

12.5 Ballast fabrics are available from Testfabrics Inc., P.O. Box 26, 415 Delaware St., W. Pittston PA 18643; tel: 570/603-0432; fax: 570/603-0433; e-mail: testfabric@aol.com, or Textile Innovators Corp., div. of SDL Atlas L.L.C., P.O. Box 8, 101 Forest St., Windsor NC; tel: 252/794-9703; fax: 252/794-9704; e-mail: tic@sdlatlas.com.

12.6 Marking pens with different size tips

are available from Mark-Tex Corp., P.O. Box 681, Englewood NJ 07631; and AATCC, P.O. Box 12215, Research Triangle Park NC 27709; tel: 919/549-8141; fax: 919/549-8933; e-mail: orders@aatcc.org.

12.7 Available from office supply or drafting equipment businesses.

12.8 A ruled template marked in percent to measure dimensional change is available from AATCC, P.O. Box 12215, Research Triangle Park NC 27709; tel: 919/549-8141; fax: 919/549-8933; e-mail: orders@aatcc.org.

12.9 When using specimens for AATCC Method 135, extend corner markings to form right angles.

12.10 Constraints of garment component size may necessitate the use of Method 2.

12.11 Marks of 460 mm (18 in.) are commonly used on fabric specimens to give better measurement precision (see 12.9).

12.12 If alternate size specimens or bench marks are used, change in fabric skewness and garment twist results may not be equal to those obtained with 250 mm (10 in.) marks.

12.13 Change in skewness and garment twist results obtained using a 1.8 kg (4.0 lb) washer load may not be equal to those obtained with a 3.6 kg (8.0 lb) washer load.

12.14 The AATCC Technical Center conducted a study to compare the 1993 AATCC Standard Reference Detergent, AATCC Standard Reference Detergent 124 and two different types of fabrics (current and proposed) to be used as ballast, under the following test conditions:

Machine cycle: (1)—Normal/Cotton Sturdy
Washing Temp: (V)— $60 \pm 3^\circ\text{C}$ ($140 \pm 5^\circ\text{F}$)
Drying Procedure: (A)i—Tumble dry, cotton sturdy cycle

Fabrics tested: White Twill (100% cotton)
Beige Twill (100% cotton)
Grey Poplin (100% cotton)
Blue Twill (50/50 poly/cotton)

No significant differences were found in the results using either detergent or ballast load fabrics.

12.15 A digital imaging system may be used as a measuring device in place of the prescribed manual measurement devices if it is established that its accuracy is equivalent to the manual devices.

Colorfastness to Light at High Temperatures: Daylight Temperature and Humidity Controlled Apparatus

Adopted in 1996 by AATCC Committee RA50 with permission from the Society of Automotive Engineers, Inc. SAE J2230[®] 1993; editorially revised and reaffirmed 1997, 2004; revised 2005.

1. Purpose and Scope

1.1 This test method specifies the operating procedures for the exposure of automotive interior trim materials in an outdoor behind-glass apparatus in which the temperature is controlled in a 24 h cycle. The humidity is controlled during the dark(night) portion of the cycle.

1.2 Specimen preparation, test durations and performance evaluation procedures are covered in material specifications of the different automotive manufacturers.

2. Principle

2.1 Samples of the textile material to be tested and the agreed upon comparison standard(s) are exposed simultaneously under specified conditions designed to accelerate the amount of irradiance imposed upon the specimens. The amount of exposure is determined with respect to a specified degree of color change, or alternately to a specific amount of radiant energy. The colorfastness of the specimen is evaluated by comparison of the color change of the exposed portion with the masked control portion of the test specimen or unexposed original material, using the Gray Scale for Color Change or by instrumental color measurement.

3. Terminology

3.1 **black panel thermometer**, n.—a temperature measuring device, the sensing unit of which is coated with black designed to absorb most of the radiant energy encountered in lightfastness testing.

3.2 **blue wool lightfastness standard**, n.—one of a group of dyed wool fabrics which are sensitive to the amount of light, heat, and moisture to which they are exposed.

NOTE: Because of the unstable nature of these materials they are also sensitive to the heat and moisture conditions which exist before exposure testing, after exposure testing and prior to measurement.

3.3 **color change**, n.—as used in *colorfastness testing*, a change in color of any kind (whether a change in hue, saturation or lightness).

3.4 **irradiation**, n.—the time integral of irradiance expressed in joules per square meter (J/m^2).

3.5 **laboratory sample**, n.—a portion of material taken to represent the lot sample, or the original material, and used in the laboratory as a source of test specimens.

3.6 **radiant exposure**, n.—time integral of irradiance.

3.7 **reference standard**, n.—a homogeneous lot of material having a known or accepted value for one or more physical or chemical properties and selected for use to verify performance of a test apparatus under specified operating conditions.

3.8 **specimen**, n.—a specific portion of a material or laboratory sample upon which a test is performed or which is selected for that purpose.

3.9 **total irradiance**, n.—radiant power integrated over all wavelengths at a point in time expressed in watts per square meter (W/m^2).

3.10 **ultraviolet radiation**, n.—radiant energy for which the wavelengths of the monochromatic components are smaller than those for visible radiation and more than about 100 nm.

NOTE: The limits of the spectral range of ultraviolet radiation are not well defined and may vary according to the user. Committee E-2.1.2 of the CIE distinguishes in the spectral range between 400 and 100 nm:

UV-A	315-400 nm
UV-B	280-315 nm
UV-C	100-280 nm

4. Safety Precautions

NOTE: These safety precautions are for information purposes only. The precautions are ancillary to the testing procedures and are not intended to be all inclusive. It is the user's responsibility to use safe and proper techniques in handling materials in this test method. Manufacturers MUST be consulted on specific details such as material safety data sheets and other manufacturer's recommendations. All OSHA standards and rules must also be consulted and followed.

4.1 Daylight exposure of the skin and eyes for prolonged periods may be hazardous and, therefore, caution should be employed to protect these areas. Under any circumstances, do not look directly at the sun or equipment and materials that

may increase the sun's intensity, such as mirrors.

4.2 Good laboratory practices should be followed. Wear prescribed safety glasses in all laboratory areas.

5. Uses and Limitations

5.1 This test method is designed to simulate extreme environmental conditions encountered inside a vehicle due to sunlight, heat, and humidity for the purpose of predicting the performance of automotive interior trim materials.

5.2 Variations in results may be expected when operating conditions are varied within the accepted limits of this test method, or tests are conducted in different geographical locations. Therefore, no reference shall be made to results from the use of this method unless accompanied by a report detailing the specific operating conditions and location conformance (see Section 12).

6. Apparatus and Materials

6.1 Mounting stand, capable of tracking the sun in elevation and rotation with an accuracy of $\pm 1^\circ$ in order to maintain the front surface of the cabinet normal to the direct beam of the sun (see Fig. 1).

6.2 Test cabinet (see Fig. 1 and 15.1), constructed of corrosion-resistant metal and containing the following:

6.2.1 Glass cover, a single piece of 3 mm (1/8 in.) thick clear tempered safety glass, such as Herculite (see 15.2), or equivalent.

6.2.2 Specimen rack, designed and positioned such that the test specimens may be mounted with the plane of the test surface parallel to, and not less than 75 mm (3 in.) below the glass.

6.2.3 Sensor, heater(s), fan(s) and a control system capable of maintaining a specified air temperature to within $\pm 5^\circ C$ ($\pm 9^\circ F$) at any location within the specimen exposure area. An example of such a system is given in Fig. 1.

6.2.4 Sensor, controller, and solenoids, evaporators, or ultrasonic humidifiers capable of controlling the relative humidity to within $\pm 10\%$ of the set humidity during the night portion of the cycle. Optionally, the wet-bulb temperature or dew point may be controlled in order to maintain the required humidity level.

6.3 Radiometer, ultraviolet, to measure irradiance, and connected to an inte-

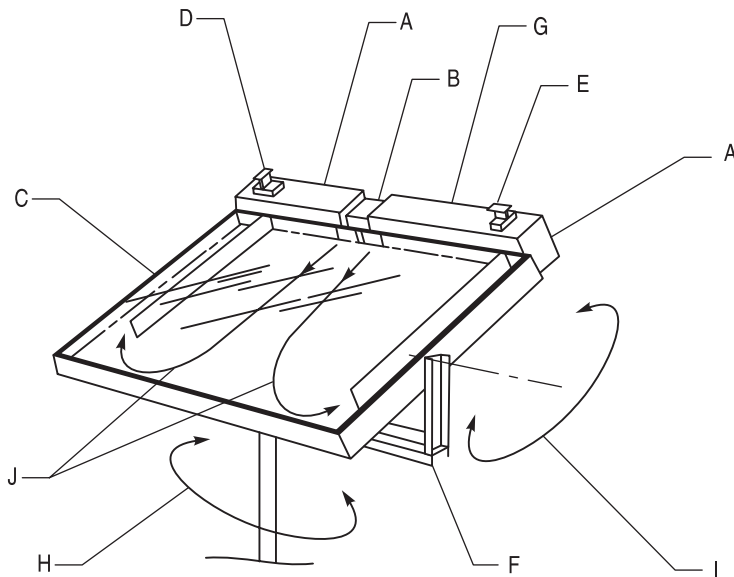

- A - Air Duct
- B - Air Blower
- C - Glass Cover
- D - Solar Cells (Azimuth Control)
- E - Solar Cells (Elevation Control)
- F - Support Yoke
- G - Air Heater (Inside Air Duct)
- H - Rotation (Azimuth Direction)
- I - Rotation (Elevation Direction)
- J - Air Circulation Pattern

Fig. 1—Exposure apparatus.

grator for computing ultraviolet radiant exposure. The ultraviolet radiometer shall be mounted behind glass, such as Herculite (see 15.2), or equivalent, in a ventilated enclosure to avoid overheating the instrument. The enclosure containing the radiometer shall maintain the same orientation as the test cabinet. Two different types of radiometers may be used:

6.3.1 A wide-band ultraviolet radiometer (see 15.3), an instrument which measures irradiance at wavelengths 295-385 nm or 300-400 nm.

6.3.2 A narrow-band ultraviolet radiometer (see 15.4), an instrument which measures irradiance centered at a wavelength of 340 ± 2 nm.

7. Calibration and Verification

7.1 Maintain and calibrate the apparatus described in Appendices A and B. Appendix A contains maintenance and calibration instructions. Appendix B describes the use of reference materials which may assist in determining the performance of the apparatus, and interpreting exposure results when compared to previous tests.

7.2 Use purified water for humidification that is free of silica and has no more than 20 ppm total dissolved solids.

8. Test Specimen Preparation

8.1 Unless otherwise specified, cut test

specimens 75×150 mm (3×6 in.), with a maximum thickness of 25 mm (1 in.). For specimens over 25 mm (1 in.) thick, formed or configured specimens, and large components, specific instructions must be agreed upon between the purchaser and the supplier.

8.2 Replicate specimens are preferred to provide a record of the changes encountered at different radiant exposure levels. Retain an unexposed specimen for comparison to the exposed specimen.

9. Conditioning

9.1 No conditioning is required except for assessment of exposed specimens as described in 11.1.

10. Procedure

10.1 Mount test specimens to the specimen rack. To minimize variations in results caused by non-uniform exposure conditions, the specimen exposure area is restricted to the dimensions provided in Appendix A.

10.2 Ensure the timer and temperature set points are accurate for the test conditions specified below:

Parameters	Day Conditions	Night Conditions
Temperature	$70 \pm 5^\circ\text{C}$ Air ($158 \pm 9^\circ\text{F}$)	$38 \pm 5^\circ\text{C}$ Air ($100 \pm 9^\circ\text{F}$)
Humidity	Not Controlled	$75 \pm 10\%$ R.H.
Hours	8 a.m.-6 p.m.	6 p.m.-8 a.m.

10.2.1 Operate continuously, except for performing maintenance as specified in Appendix A, inspecting specimens, removing specimens or starting new tests.

10.3 Use one of the following procedures for timing the exposure.

10.3.1 Expose specimens for the specified radiant exposure measured in MJ/m^2 total ultraviolet, 295-385 nm or 300-400 nm.

10.3.2 Expose specimens for the specified radiant exposure measured in $\text{kJ}/\text{m}^2/\text{nm}$ at 340 ± 2 nm.

11. Evaluation

11.1 After the test exposure is completed, remove the test specimens and any comparison standards from exposure. Condition in a dark room at standard conditions for testing textiles $21 \pm 1^\circ\text{C}$ ($70 \pm 2^\circ\text{F}$) and RH of $65 \pm 2\%$ for a minimum of 4 h before evaluation.

11.2 Evaluate and report the degree of fade as specified between the contractual parties. Instrumental values are recommended.

11.2.1 Instrumental Measurement.

11.2.1.1 Determine the color difference values in CIELAB units by instrumentally measuring the specimen before and after a specified amount of radiant exposure. The instrument used for specimen measurement shall conform to that specified in Appendix B.2.

11.2.2 Visual Assessment.

11.2.2.1 Assign colorfastness grades using the Gray Scale for Color Change in accordance with AATCC Evaluation Procedure 1 (see 15.6).

11.2.2.2 Using the viewing conditions specified in AATCC Evaluation Procedure 1, quantify the color change using the following terminology:

- NONE: No change in hue, lightness or chroma.
- SLIGHT: A change in lightness and/or chroma which can be determined only upon close examination but no change in hue.
- NOTICEABLE: A change in lightness and/or chroma which can easily be seen and/or a change in hue.
- SEVERE: An extreme change in lightness, chroma, and/or hue.

12. Report

12.1 The final report form shall contain the following:

12.1.1 Laboratory and location.

12.1.2 Type and serial number of exposure apparatus.

12.1.3 Test method.

12.1.4 Specimen exposure area temperature controlled at $xx^\circ\text{C}$ (black panel or air).

12.1.5 Specimen identification.

12.1.6 Total radiant exposure (MJ/m²/295-385 nm or 300-400 nm) or (kJ/m²/340 nm).

12.1.7 Date specimen exposure was initiated.

12.1.8 Date specimen exposure was completed.

12.1.9 Special conditions which may have existed during a specific test period, such as control failure, unusual atmospheric conditions, etc.

13. Precision and Bias

13.1 *Precision.* Precision for this test method has not been established. Until a precision statement is generated for this method, use standard statistical techniques in making any comparisons of test results for either *within-laboratory* or *between-laboratory* averages.

13.2 *Bias.* The colorfastness to light at high temperatures can only be defined in terms of a test method. There is no independent method for determining the true value. As a means of estimating this property, the method has no known bias.

14. References

14.1 AATCC Evaluation Procedure 1, Gray Scale for Color Change, AATCC TECHNICAL MANUAL (see 15.6).

14.2 ASTM E 824, Standard Method for Transfer of Calibration From Reference to Field Pyranometers, ASTM, 100 Barr Harbor Dr., West Conshohocken PA 19428; tel: 610/832-9500; fax: 610/832-9555.

14.3 SAE J1545, Instrumental Color Difference Measurement for Exterior Finishes, Textiles, and Colored Trim, Society of Automotive Engineers Inc., 400 Commonwealth Dr., Warrendale PA 15096-0001.

14.4 SAE J2230, Accelerated Exposure of Automotive Interior Trim Materials Using Outdoor Under-Glass Controlled Sun-Tracking Temperature and Humidity Apparatus, Society of Automotive Engineers Inc. (see 14.3).

15. Notes

15.1 Available from SDL Atlas L.L.C., 1813A Associate Lane, Charlotte NC 28217; tel: 704/329-0911; fax: 704/329-0914; e-mail: info@sdatlas.com, or equivalent.

15.2 Herculite is a registered trademark of PPG Industries.

15.3 Available as model TUVR from Eppley Laboratories, 12 Sheffield Ave., Newport, RI 02840; tel: 401/847-1020, or equivalent.

15.4 Available as model LM3A from SDL Atlas L.L.C., 1813A Associate Lane, Charlotte NC 28217; tel: 704/329-0911; fax: 704/329-0914; e-mail: info@sdatlas.com, or equivalent.

15.5 Franklin, Grain long-felt side up, 1101500 white index made by Union Camp or 9016 White Bristol Card Stock are suitable for this purpose. Franklin white index is usually available from local office supply or art stores and is also available from Dilliard Paper Co. Any equivalent may be used.

15.6 Available from the AATCC, P.O. Box

12215, Research Triangle Park NC 27709; tel: 919/549-8141; fax: 919/549-8933; e-mail: orders@aatcc.org.

15.7 Polystyrene Plastic Lightfastness Standard (PPLS) may be obtained from Testfabrics Inc., P.O. Box 26, 415 Delaware St., W. Pittston PA 18643; tel: 570/603-0432; fax: 570/603-0433; e-mail: testfabric@aol.com.

APPENDIX A

A1. Maintenance

A1.1 *Specimen Mounting.* Check specimens daily to ensure they are properly mounted.

A1.2 *Glass Cover.* Inspect the glass cover weekly, and both surfaces cleaned whenever there is visual evidence of dirt accumulation or other undesirable deposits.

A1.3 *Ultraviolet Radiometer.* Clean the glass cover and the diffusing lens daily with deionized water. Replace the desiccant visible through the sight glass whenever the color changes from dark blue to light pink.

A1.4 *Temperature, Humidity Control System.* Check temperature and humidity readouts once during the day cycle and once during the night cycle each day to ensure proper operation of the thermocouples, humidity sensors, heaters, air circulation fans, etc.

A2. Calibration

A2.1 *Temperature.* Check the temperature sensor that controls the chamber temperature using a NIST traceable temperature sensor at the chamber set points at least every 6 months. Adjust or replace the sensor when the measured temperature fails to agree with the reference by an average of more than $\pm 1.5^\circ\text{C}$ ($\pm 3.0^\circ\text{F}$).

A2.2 *Temperature Uniformity.* Check the temperature uniformity within the planned exposure area at least every 6 months using Type T thermocouples placed as shown in Fig. A2.1.

A2.2.1 Monitor thermocouples at least every 15 min for a 24 h period. Limit the exposure area to the area over which the temperature can be maintained within

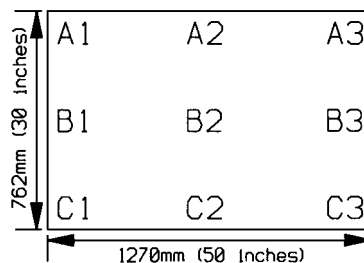

Fig. A2-1—Thermocouple placement/exposure area.

$\pm 5^\circ\text{C}$ ($\pm 9^\circ\text{F}$) of the temperature setpoint.

A2.3 *Irradiance.* Perform an absolute calibration at least every 6 months either by using a spectroradiometer, by returning the unit to the manufacturer, or by comparing the instrument to a reference instrument in accordance with ASTM E 824.

APPENDIX B

B1. General

B1.1 This appendix describes the procedure for using an AATCC Blue Wool Lightfastness Standard (L4) (see 15.6) and a Polystyrene Plastic Lightfastness Standard (PPLS) (see 15.7) as reference materials for the purpose of determining whether the exposure cabinet is operating within the required range.

NOTE: It has not been verified that these reference materials can be used as a check on a test cabinet or operating conditions for outdoor exposure tests due to seasonal variations in ultraviolet, temperature, relative humidity and time of wetness during the uncontrolled portion of the test.

B1.2 Color difference values in CIELAB ΔE units for the L4 and CIELAB Δb units for the PPLS are obtained by measuring the reference materials before and after a specified radiant exposure.

B1.3 Expose the L4 and PPLS reference materials for 20.0 MJ/m² at 295-385 nm.

B2. Instrumentation

B2.1 Instruments used to determine color difference for this procedure require capability for providing CIELAB color values using illuminant D₆₅, 10° standard observer data. If an instrument with diffuse geometry is used, the specular component of reflectance shall be included in the measurement (refer to SAE J1545 for additional information).

B2.1.1 Do not use an aperture diameter smaller than 20.0 mm (0.8 in.) for these measurements.

B2.2 Calibrate the instrument to be used for the color measurements according to the manufacturer's recommendations.

B3. AATCC Blue Wool Lightfastness Standards

B3.1 Back the reference fabric to be measured with white cardboard (see 15.5). Condition the backed reference fabric in a standard atmosphere $50 \pm 5\%$ RH and $21 \pm 1^\circ\text{C}$ ($70 \pm 2^\circ\text{F}$) for a minimum of 2 h. Insert one layer of unexposed material of the same lightfastness standard between the reference fabric and the backing prior to measurement.

NOTE: The reference fabrics are light

sensitive. Therefore, the piece used as the backing layer during measurement will need to be replaced when noticeable color change has occurred (after approximately 50 uses).

B3.2 Place the reference fabric against the sample port of the instrument in such a way that a smooth surface of the face of the fabric is presented for measurement.

B3.3 After taking an initial reading in CIELAB units, rotate the reference fabric 90° and take a second reading. Average the readings and store as the standard measurement for the identified piece of reference fabric. REMOVE THE BACKING FABRIC AND PLACE IN A LIGHT TIGHT CONTAINER FOR LATER USE.

NOTE: The measurement obtained in B3.3 cannot be used for different pieces of reference fabric. Each individual piece must be conditioned and measured prior to exposure.

B3.4 Place cardboard backed reference fabric (single layer) at the center of the sample exposure area.

B3.5 After the specified radiant exposure, remove the reference fabric and the

white cardboard backing from the exposure apparatus.

B3.6 Repeat the conditioning and color measurement steps specified in B3.1 through B3.3 on the exposed reference fabric(s), and using the previously stored pre-exposure measurement determine the ΔL^* , a^* , b^* and E^* .

B3.7 As each group of reference fabrics completes its specified radiant exposure, record the color change information in terms of ΔL^* , a^* , b^* and E^* . Retain these data and make available upon request, for at least one year.

B4. Polystyrene Plastic Lightfastness Standard

B4.1 *Reflectance Mode.*

B4.1.1 Place a piece of unexposed reference plastic, backed with a white calibration tile against the sample port of the instrument.

B4.1.2 Take an initial reading and store it as the standard measurement for the identified piece of reference plastic.

B4.2 *Transmission Mode.*

B4.2.1 Place a piece of unexposed ref-

erence plastic in the proper location for measuring transmittance as recommended by the manufacturer of the instrument in use.

B4.2.2 Place the white tile used for calibration against the outer sample port of the instrument.

B4.2.3 Take an initial measurement and store it as the standard measurement for the identified piece of reference plastic.

B4.3 Place the PPLS reference material at the center of the sample exposure area.

B4.4 After the specified radiant exposure, remove the reference plastic from the apparatus.

B4.5 Repeat the color measurement steps specified in B4.1-B4.2 on the exposed reference plastic(s), and using the previously stored pre-exposure measurement determine the Δb^* .

B4.6 As each group of reference plastics completes its specified radiant exposure, record the color change information in terms of Δb^* . Retain these data and make available upon request for at least one year.

Relative Color Strength of Dyes in Solution

Established in 1998 by AATCC Committee RA98; under jurisdiction of AATCC Committee RA36; reaffirmed 1999, 2005; editorially revised and reaffirmed 2000. Technically equivalent to ISO 105-Z10.

1. Purpose and Scope

1.1 This is a test method to determine the color strength of a dye sample relative to a reference dye by means of spectrophotometric transmittance measurements on solutions of each. It is a comparison of the color strength of the dyes in a chosen solvent which may or may not correspond to strengths when applied to a textile substrate.

1.2 To be valid as a measurement of the relative color strength of a dye for a particular textile end-use, additional tests must be performed to demonstrate that the relative strength in solution is equal to the relative strength when applied to the textile substrate (see 5.4).

1.3 The test is often used by dye manufacturers and users because of its speed, repeatability and reproducibility.

2. Principle

2.1 Solutions of the test dye and the reference dye are prepared in known concentrations and their transmittance values are determined using a spectrophotometer. The relative color strength for the test dye is then calculated using absorbance and concentration values.

3. Terminology

3.1 **absorbance**, *n.*—the logarithm to the base 10 of the reciprocal of transmittance.

NOTE: Absorbance is proportional to the mass of absorbing material in the path length of a spectrophotometer cell (*syn: absorbance value*).

3.2 **color strength**, *n.*—a measure of the ability of a dye to impart color to other materials.

NOTE: Color strength is evaluated by light absorption in the visible region of the spectrum (see 13.1).

3.3 **relative color strength**, *n.*—*in spectrophotometric testing of dyes*, the percentage of the color strength of a sample relative to that of a reference dye assigned a color strength of 100% (see 10.2).

3.4 **transmittance**, *n.*—*of light*, that fraction of the incident light of a given wavelength which is not reflected or absorbed, but passes through a substance.

NOTE: In this test, the transmittance of the material is measured on a spectrophotometer, and corrected for that of pure solvent for the same path length.

4. Safety Precautions

NOTE: These safety precautions are for information purposes only. The precautions are ancillary to the testing procedures and are not intended to be all inclusive. It is the user's responsibility to use safe and proper techniques in handling materials in the test method. Manufacturers MUST be consulted for specific details such as material safety data sheets and other manufacturer's recommendations. All OSHA standards and rules must also be consulted and followed.

4.1 Good laboratory practices should be followed. Wear safety glasses in all laboratory areas.

4.2 All chemicals should be handled with care.

4.3 Use chemical goggles or face shield, impervious gloves, and an impervious apron during dispersing and mixing of acids, alkalis and organic solvents. Concentrated acids, alkalis and organic solvents should be handled in a well ventilated hood. CAUTION: Always add acid to water.

4.4 Acetone, methyl alcohol and ethyl alcohol are highly volatile liquids and should be stored in the laboratory only in small containers away from heat, open flames and sparks. These chemicals should not be used near an open flame.

4.5 Cellosolve (2-ethoxyethanol) is combustible and may be harmful or fatal if ingested or inhaled. It is also a reproductive hazard and should only be used when absolutely necessary.

4.6 An eyewash/safety shower should be located nearby and an organic vapor respirator and a self contained breathing apparatus should be readily available for emergency use.

4.7 Exposure to chemicals used in this procedure must be controlled at or below levels set by government authorities [e.g., Occupational Safety and Health Administration's (OSHA) permissible exposure limits (PEL) as found in 29 CFR 1910.1000 of January 1, 1989]. In addition, the American Conference of Industrial Hygienists (ACGIH) Threshold Limit Values (TLVs) comprised of time weighted averages (TLV-TWA), short term exposure limits (TLV-STEL) and ceiling limits (TLV-C) are recommended as a general guide for air contaminant exposure which should be met (see 14.1).

5. Uses and Limitations

5.1 This method is not applicable to all dyestuffs; e.g., pigments, due to solubility and/or other limitations. Dyes that are commonly measured include acid, basic, direct and disperse. Many reactive dyes are not easily measured using this procedure.

5.2 Basic requirements for this method are that the dye solutions do not scatter light and do obey the Lambert-Beer or Beer-Bouguer Laws as well as having identical or similar absorption curves of the samples and the reference dyes in the visible region of the spectrum (see 13.9).

5.3 Identical or similar absorption curves are usually obtained if the tests are carried out for the purpose of dye production control of batches/deliveries of the same dye. This method is not applicable for the evaluation of dyes with distinctly different hues or strengths or chemical compositions.

5.4 The method may be useful in the prediction of relative dye strength in process applications; e.g., dyeing. It is generally accepted that some reasonable correlation can be obtained between application and solution measurements. Exceptions occur where there is a significant difference in the relative amount of colored but non-exhausting or non-fixing impurities between the specimen under test and the reference dye; e.g., reactive dyes. Exceptions may also occur for some reactive dyes which exhibit shade differences between their hydrolyzed and unreacted forms (see additional caution for reactive dyes in 8.3.3).

5.5 As the relative color strength is determined by a comparison with a reference dye, the reference dye is assumed to remain constant. It is essential, therefore, to ensure careful storage and control of the reference dye. Many dyes are hygroscopic and sensitive to oxidation. Protect the reference dye from exposure to light in firmly sealed containers that are impervious to moisture.

6. Apparatus and Materials

6.1 Flasks, volumetric class A.

6.2 Pipettes, volumetric class A.

6.3 Analytical balance with accuracy of weighing to 0.0005 g.

6.4 Cells for spectrophotometers, 5 mm or 10 mm path length as needed, analytical grade or optical quality. May be cuvette or flow-through cell.

6.5 Spectrophotometer.

7. Reagents

- 7.1 Sulfuric acid—H₂SO₄.
- 7.2 Acetic acid—CH₃COOH.
- 7.3 Sodium hydroxide—NaOH.
- 7.4 Sodium carbonate—Na₂CO₃.
- 7.5 Buffering agents.
- 7.6 Solvents (see 13.3).
 - 7.6.1 For water-soluble dyes:
 - 7.6.1.1 Water, demineralized.
 - 7.6.2 For water-insoluble dyes:
 - 7.6.2.1 Methyl alcohol (CH₃OH, methanol), anhydrous.
 - 7.6.2.2 Acetone (CH₃COCH₃).
 - 7.6.2.3 N-methyl-2-pyrrolidone.
 - 7.6.2.4 Ethylene glycol monoethyl-ether (2-ethoxyethanol, Cellosolve).
 - 7.6.2.5 Mixtures of the above solvents as well as other solvents appropriate for the test dye.

8. Preparation of Dye Solutions

- 8.1 Storage of dyes.
 - 8.1.1 Store the samples in tightly sealed containers to avoid erroneous results arising from changes in moisture levels. Condition powder samples in a controlled atmosphere for 4 h as described in ASTM D 49.
- 8.2 Stock solutions.
 - 8.2.1 Weigh an amount of not less than 0.5 g to avoid errors attributable to micro-inhomogeneities to the nearest 0.0005 g (see 13.4 and 13.8).
 - 8.2.2 Transfer the weighed dye quantitatively to a volumetric flask containing approximately one-third of the total volume of solvent, then dissolve/disperse it. In general, pre-dissolve/disperse the dye in about 20 mL of the selected solvent. A mixture of solvents or an additive may be needed.
 - 8.2.2.1 Water-soluble dyes may need to be heated to effect dissolution. If heated, cool the dissolved/dispersed mixture to room temperature (see 13.5).
 - 8.2.3 Make up the volumetric flasks to the mark and homogenize the solution/dispersion by stirring or by turning the flask end over end.
 - 8.3 Test solutions.
 - 8.3.1 Dilute the concentrated stock solution as directed (see 13.6) to obtain maximum absorption (the minimum transmittance at the lowest point) within the range of 10-60% transmittance (see 13.5). (The same solvents used to make the concentrated stock solution may not be the appropriate choice for dilution. For example, many disperse dyes are dispersed into water for the stock solution, and then pipetted into a solvent/water mixture for dilution.)
 - 8.3.2 Some additives may be recommended to improve the stability and reproducibility.
 - 8.3.3 To adjust the pH of water soluble dyes use an acid such as acetic or sulfuric, a base such as sodium carbonate or

sodium hydroxide, or a buffering agent. (However, sodium carbonate or sodium hydroxide should not be used with reactive dyes.)

8.3.4 To eliminate the influence of unwanted metal ions use a sequestering agent.

8.3.5 To prevent agglomeration in water use a surfactant; e.g., ethylene oxide adducts to alkanols.

8.3.6 Use a dispersing agent or an antioxidant, if appropriate.

8.3.7 Volumetric equipment and solvents should be at ambient temperature.

9. Procedure

9.1 When a dye specimen is measured for the first time, it is advisable to confirm the validity of the relationship (Beer's Law) under the conditions selected (concentration, solvent) within a range of concentrations equal to one-half and twice the concentration actually used.

9.2 Determine the wavelength (λ) of minimum % transmittance. The test and the reference specimens should have the same wavelength of minimum % transmittance.

9.3 Carry out the measurement as soon as possible after preparation of the solution to exclude the influence of changes in solution.

9.4 Adopt appropriate techniques with light sensitive solutions; e.g., using darkened flasks, or working in dimly lit surroundings (see 13.7).

9.5 Measure the transmittance of the solution in cells (cuvette or flow-through cell) of identical path length (usually 5 mm or 10 mm).

9.5.1 The difference in absorbance between the test dye and reference dye shall not exceed 20%, to minimize the influence of variations in the spectrophotometric response over a relatively wide range of concentrations.

9.5.2 The transmittance, T , of the dye solution is obtained differently with a double-beam spectrophotometer compared to a single-beam spectrophotometer, but yields the same result. With a double-beam instrument, simultaneous measurements may be made with a cell of pure solvent placed in the reference beam, and the dye solution in the sample beam. Single-beam instruments require that the instrument first be standardized with pure solvent. Then, the dye specimens are measured successively in the same cell.

9.5.3 Some narrow (0.5-2.0 nm) band-pass, analytical spectrophotometers used for dye strength determination measure both transmittance and absorbance, directly. In this case, it is not necessary for the system or the user to calculate the absorbance separately.

10. Calculations

10.1 Base the evaluation on Beer's law, using the following equation:

$$A = \log_{10}(1/T_{\lambda}) \quad (1)$$

10.1.1 A is the absorbance at wavelength of minimum transmittance (see 13.2).

10.1.2 T_{λ} is the transmittance (in decimal fraction form, where 100% = 1.0) at wavelength of minimum transmittance.

10.2 Calculate the relative color strength to the nearest 0.1% using the following equation:

$$F_s = 100 (A_2 C_1 / A_1 C_2) \quad (2)$$

where:

F_s is relative color strength in percent
 C is the dye concentration
subscript 1 refers to the reference dye
subscript 2 refers to the dye under test

10.2.1 Assuming $C_1 = C_2$, the following simplified equation is obtained:

$$F_s = 100 (A_2 / A_1) \quad (3)$$

11. Report

- 11.1 Identification of test dye.
- 11.2 Dye mass.
- 11.3 Solvent used (if solvent system is light-sensitive, note illumination conditions).
- 11.4 Dissolving conditions (e.g., temperature, also include names and concentrations of any additives used to improve stability and reproducibility, per 8.4).
- 11.5 Dilution factor.
- 11.6 Concentration and temperature of measured solution.
- 11.7 Measuring instrument (e.g., type and band width).
- 11.8 Cell path length.
- 11.9 Wavelength of analysis, also note bandpass and reporting interval of spectrophotometer.
- 11.10 Relative color strength.
- 11.11 Conditions under which dye was stored.

12. Precision and Bias

12.1 Precision.

12.1.1 An interlaboratory study by ten laboratories was conducted in 1987. Absorbance was measured using aqueous visible transmittance spectroscopy. A round-robin test battery yielded the results of the test. Several different spectrophotometers were used to determine variance between instruments as well as laboratories. Sample preparation varied as described by this test method for readily soluble dyes and solvent/aqueous solution soluble dyes (disperse dyes). These data are on file at the AATCC Technical Center.

12.1.2 Intra-Lab Variation: The maxi-

imum percent coefficient of variation (%C.V.) calculated as:

$\%C.V. = s/\text{mean} \times 100$ for any given lab was 5.20% for Disperse Blue 56.

12.1.3 Typical %C.V. for water-soluble dyes are below 1%, provided they are sufficiently dissolved. Acid dyes used in the test had typical %C.V. values of 2.0%. Many of the labs in the study indicated that their internal standards for day-to-day and intra-lab variation is $\pm 0.5\%$.

12.1.4 Inter-Lab Variation: The maximum %C.V. for between-lab analysis was 6.55% for Disperse Blue 56. Typical %C.V. for water-soluble dyes are below 5%, provided they are sufficiently dissolved.

12.1.5 Spectroscopic measurement of disperse dyes in aqueous/solvent mixtures often yield worse precision than shown for water-soluble dyes, due largely to variances in the solubilities of the disperse dyes. As solubility decreases, light scattering increases, which will lead to higher error levels. For this reason, a given dye is best characterized when it is best dissolved.

12.1.6 One major source of deviation was the use of different spectrophotometers. In several studies, no one single wavelength of maximum absorptivity (transmittance minimum) was used for any of the dyes. Other possible sources of error often include differences in time after initial dissolution; a dye's absorptivity can increase over time after initial dilution until it reaches a maximum. Solution temperature and cis-trans (and azo-hydrazone) isomerism can lead to variability. It is possible and recommended that laboratories develop correction factors (correlation models) between instruments and

laboratories to reduce these errors.

12.1.7 Table I shows *inter-* and *intra-laboratory variability* for the disperse dyes (worst case) studied. Some data points from the study failed the 1.5 IQR fit test and were not included in the data analysis.

12.2 Bias.

12.1.1 There is no independent referee analytical method for determining a true value of this property. This test method has no known bias.

13. Notes

13.1 Color strength is traditionally a coloristic concept, being based essentially on visual assessment. Therefore, color strength determined instrumentally should not contradict visual assessment. Such a contradiction would not be expected if the samples to be compared exhibit concentration-dependent differences in absorption only; i.e., their absorption curves in the visible region are identical or show only small differences when the strength of the absorption curves is made equal.

13.2 If the absorption curves differ more markedly (hue or chroma differences), a better visual assessment may be obtained if the summed weighted color strength in the visible region is used.

13.3 When selecting solvents the following aspects are important:

13.3.1 Solubility of dye.

13.3.2 Stability of solutions.

13.3.3 Reproducibility of test.

13.3.4 Applicability of result to other media or practical applications.

13.4 It is essential to ensure that uptake of moisture by hygroscopic dye samples does not lead to errors during weighing.

13.5 It is essential to ensure that the solubility limit is not exceeded during subsequent cooling. Solubility specifications are available from the dye suppliers.

13.6 To avoid errors in dilution, no pipette of total volume less than 5 mL nor volumetric

flask less than 100 mL should be used.

13.7 In certain instances, the solution to be measured may be influenced adversely by the light energy of the source in the measuring instrument (e.g., heat-sensitive or photo-sensitive products). If so, monochromatic illumination, shutter or flash light source should be used.

13.8 When measuring liquid dye samples, it is essential that the sample be thoroughly mixed before an aliquot is taken. If the sample is retained for future use, it must be sealed in a container protected from exposure to light and impervious to moisture.

13.9 A simple method to determine qualitatively the presence of solid dye/dispersing agents in what may appear to be clear solutions is to filter the dye solution through a sub-micrometer filter using a simple syringe filter as is often used in HPLC and determine the absorbance before and after filtration.

14. References

14.1 Publications Office, ACGIH, Kemper Woods Center, 1330 Kemper Meadow Dr., Cincinnati, OH 45240; tel: 513/742-2020.

14.2 General procedure for the determination of relative dye strength by spectrophotometric transmittance measurement (report of the ISCC): R. G. Kuehni, *Textile Chemist and Colorist*, Vol. 4, 1972, p133.

14.3 Difficulties in preparing dye solutions for accurate strength measurement: T. R. Commerford, *Textile Chemist and Colorist*, Vol. 6, 1974, p14.

14.4 Reproducibility of dye strength evaluation by spectrophotometric transmission measurement (report of the ISCC): C. D. Sweeny, *Textile Chemist and Colorist*, Vol. 8, 1976, p31.

14.5 ISO proposed test method 105-Z10, 94/341270.

14.6 AATCC (Committee RA98) training video tape "Techniques for Solution Measurement Used in Dye Strength Determination," (1995) AATCC Committee RA98, Assessment of Dye Strength and Shade Test Methods.

14.7 Possible Test Method for Determining Strength of Acid Dyes: B. L. McConnell, *Textile Chemist and Colorist*, Vol 24, No. 2, February 1992, p23.

14.8 Can A Standard Test Be Developed For Measuring the Strength of Disperse Dyes?, M. D. Hurwitz, *Textile Chemist and Colorist*, Vol 25, No. 9, September 1993, p71.

Table I—Inter- and Intra-Laboratory Variability

Disperse Dye	Yellow 54	Red 60	Blue 56
Intra-Lab %C.V. Maximum	0.75%	1.27%	5.20%
Inter-Lab %C.V. Maximum	1.07%	1.42%	6.55%

Transmittance or Blocking of Erythemally Weighted Ultraviolet Radiation through Fabrics

Developed in 1998 by AATCC Committee RA106; reaffirmed 1999, 2000; revised 2004.

1. Purpose and Scope

1.1 This standard test method is used to determine the ultraviolet radiation blocked or transmitted by textile fabrics intended to be used for UV protection.

1.2 This method provides procedures for measuring this fabric property with specimens in either the dry or wet states.

2. Principle

2.1 The transmission of ultraviolet radiation (UV-R) through a specimen is measured on a spectrophotometer or spectroradiometer at known wavelength intervals.

2.1.1 The ultraviolet protection factor (UPF) is computed as the ratio of the erythemally weighted ultraviolet radiation (UV-R) irradiance at the detector with no specimen to the erythemally weighted UV-R irradiance at the detector with a specimen present.

2.1.2 The erythemally weighted UV-R irradiance at the detector with no specimen present is equal to the summation between wavelength intervals of the measured spectral irradiance times the relative spectral effectiveness for the relevant erythral action spectra times the UV-R weighting function of the appropriate solar radiation spectrum times the appropriate wavelength interval.

2.1.3 The erythemally weighted UV-R irradiance at the detector with a specimen present is equal to the summation between wavelength intervals of the measured spectral irradiance times the relative spectral effectiveness for the relevant erythral action spectrum times the spectral transmittance for the specimen times the wavelength interval.

2.1.4 The percent blocking of UVA and UVB radiation is also calculated.

3. Terminology

3.1 erythema, n.—abnormal redness of the skin (sunburn) due to capillary congestion (as in inflammation).

3.2 percent UV blocking, n.—100 minus the UV transmission.

3.3 ultraviolet protection factor (UPF), n.—the ratio of the average effective ultraviolet radiation (UV-R) irradi-

ance transmitted and calculated through air to the average effective UV-R irradiance transmitted and calculated through fabric.

3.4 ultraviolet radiation, n.—radiant energy for which the wavelengths of the monochromatic components are smaller than those for visible radiation and more than about 100 nm.

NOTE: The limits of the spectral range of ultraviolet radiation are not well defined and may vary according to the user. Committee E-2.1.2 of the International Commission on Illumination (CIE) (see 15.4) distinguishes in the spectral range between 400 and 100 nm:

UV-A	315-400 nm
UV-B	280-315 nm
UV-R	280-400 nm

4. Safety Precautions

NOTE: These safety precautions are for information purposes only. The precautions are ancillary to the testing procedures and are not intended to be all inclusive. It is the user's responsibility to use safe and proper techniques in handling materials in this test method. Manufacturers MUST be consulted on specific details such as material safety data sheets and other manufacturer's recommendations. All OSHA standards and rules must also be consulted and followed.

4.1 Under any circumstances, do not look directly at the equipment and materials that may increase the light source intensity, such as mirrors.

4.2 Good laboratory practices should be followed. Wear prescribed safety glasses in all laboratory areas.

5. Uses and Limitations

5.1 This method can also be used to determine the UPF of fabrics in a stretched state. However, the techniques for stretching the specimens are not part of this method and are addressed in a separate test procedure. It must be noted that stretching the specimens could change the UPF properties.

6. Apparatus and Materials

6.1 A spectrophotometer or spectroradiometer equipped with an integrating sphere (see 15.1 and, for a more complete description of an instrument, Appendix A).

6.2 As indexed in catalogues: Filter, Schott Glass UG11 (see 15.2).

6.3 Clear plastic food wrap for use with wet samples (polyvinylidene chloride or polyvinylchloride film).

6.4 AATCC Blotting paper (see 15.5).

7. Instrument Verification and Calibration

7.1 Calibration. Calibrate the spectrophotometer or spectroradiometer according to manufacturer instructions. The use of physical standards are recommended for validating the measurement of spectral transmittance.

7.1.1 When running a wet sample place the plastic wrap over the port and repeat calibration.

7.2 Wavelength scale. Calibrate the wavelength scale of the spectrophotometer or spectroradiometer using the spectral emission lines of an electrical discharge in mercury vapor. The wavelength calibration of a spectrophotometer can be performed using the absorption spectra of a holmium oxide glass filter. Reference wavelengths for both mercury arc emission and holmium oxide absorption are provided in ASTM Practice E 275, Standard Practice for Describing and Measuring Performance of Ultraviolet, Visible and Near-Infrared Spectrophotometers.

7.2.1 Transmittance scale. Set the transmittance scale to a 100% value by operating the instrument without a sample in the optical path; therefore, referenced to air. The 0% value can be subsequently verified by fully obstructing the sample beam path with an opaque material. Validate the linearity of the transmittance scale by means of either calibrated neutral density filters or calibrated perforated screens supplied by the instrument manufacturer or standardizing laboratories.

8. Specimens

8.1 Test a minimum of two (2) specimens from each sample for the wet and the dry testing. Cut each specimen at least 50 × 50 mm (2.0 × 2.0 in.) or 50 mm (2.0 in.) in diameter. Avoid distorting the specimen during preparation and handling.

8.1.1 Should the fabric have areas of different colors or structure, test each color or structure if its size is sufficient to cover the measuring port.

8.2 See Appendix A5 for specimens exhibiting fluorescence.

9. Conditioning

9.1 For dry specimens.

9.1.1 Prior to testing, precondition and condition the test specimens as directed in ASTM D 1776, Standard Practice for Conditioning and Testing Textiles. Condition each specimen for at least 4 h in an atmosphere of $21 \pm 1^\circ\text{C}$ ($70 \pm 2^\circ\text{F}$) and $65 \pm 2\%$ RH by laying each test specimen separately on a perforated shelf or conditioning rack.

10. Procedure

10.1 Dry Evaluation.

10.1.1 Place the specimen flush against the sample transmission port opening in the sphere.

10.1.2 Make one UV transmission measurement with the specimen oriented in one direction, a second measurement at 0.79 rad (45°) to the first and a third at 0.79 rad (45°) to the second. Record the individual measurements.

10.1.3 On multicolored specimens, determine the area of highest UV transmission and make the three measurements in that area.

10.2 Wet Evaluation

10.2.1 Weigh the test specimen. Thoroughly wet out the specimen in distilled water by placing it flat in the bottom of a beaker and then pour distilled water into the beaker until the specimen is covered. Allow the specimen to remain submerged for 30 minutes. Press and move the specimen from time to time to ensure a good and uniform penetration. Prepare only one specimen at a time.

10.2.2 Bring the wet pick-up to $150 \pm 5\%$ by squeezing the wet specimen between blotting paper (see 6.4) through a hand wringer or similar convenient means (such as squeeze between two glass rods). If the fabric has low moisture absorption, repeat the soaking and wringing steps. Note, some samples may not be capable of achieving the specified wet pick-up such as tightly woven synthetic fabrics.

10.2.3 Use plastic wrap over viewing port to protect instrument from water.

10.2.4 Continue as directed in 10.1. Avoid evaporative reduction of the moisture content below the specified level before the actual UV transmission measurements are made.

11. Calculations

11.1 Calculate the average spectral transmittance for the three measurements on each specimen.

11.2 Calculate the Ultraviolet Protection Factor (UPF) of each specimen using Equation 1:

Table I—Relative Erythral Effectiveness Function (E_λ)^a

nm	response	nm	response	nm	response
280	1.00e+00	320	8.55e-03	360	4.84e-04
282	1.00e+00	322	5.55e-03	362	4.52e-04
284	1.00e+00	324	3.60e-03	364	4.22e-04
286	1.00e+00	326	2.33e-03	366	3.94e-04
288	1.00e+00	328	1.51e-03	368	3.67e-04
290	1.00e+00	330	1.36e-03	370	3.43e-04
292	1.00e+00	332	1.27e-03	372	3.20e-04
294	1.00e+00	334	1.19e-03	374	2.99e-04
296	1.00e+00	336	1.11e-03	376	2.79e-04
298	1.00e+00	338	1.04e-03	378	2.60e-04
300	6.49e-01	340	9.66e-04	380	2.43e-04
302	4.21e-01	342	9.02e-04	382	2.26e-04
304	2.73e-01	344	8.41e-04	384	2.11e-04
306	1.77e-01	346	7.85e-04	386	1.97e-04
308	1.15e-01	348	7.33e-04	388	1.84e-04
310	7.45e-02	350	6.84e-04	390	1.72e-04
312	4.83e-02	352	6.38e-04	392	1.60e-04
314	3.13e-02	354	5.96e-04	394	1.50e-04
316	2.03e-02	356	5.56e-04	396	1.40e-04
318	1.32e-02	358	5.19e-04	398	1.30e-04
				400	1.22e-04

Note: The intervals in Table I are in 2 nm. For 5 nm UV transmission data use the interpolated data between those ending in a "4" and a "6."

^a CIE Publication 106/4 available from CIE National Committee of USA, c/o TLA-Lighting Consultants Inc., 7 Pond St., Salem, MA 01970.

Table II—Solar Spectral Irradiance of Noonday, July 3, Sunlight, Albuquerque, NM (S_λ)^a

nm	W/cm ² /nm	nm	W/cm ² /nm	nm	W/cm ² /nm
280	4.12e-11	320	3.14e-05	360	5.64e-05
282	2.37e-11	322	3.32e-05	362	6.00e-05
284	3.14e-11	324	3.61e-05	364	6.48e-05
286	4.06e-11	326	4.45e-05	366	7.18e-05
288	6.47e-11	328	5.01e-05	368	7.62e-05
290	3.09e-10	330	5.32e-05	370	7.66e-05
292	2.85e-09	332	5.33e-05	372	7.50e-05
294	2.92e-08	334	5.23e-05	374	6.61e-05
296	1.28e-07	336	5.04e-05	376	6.66e-05
298	3.37e-07	338	4.99e-05	378	7.46e-05
300	8.64e-07	340	5.39e-05	380	7.54e-05
302	2.36e-06	342	5.59e-05	382	6.42e-05
304	4.35e-06	344	5.35e-05	384	5.85e-05
306	7.19e-06	346	5.34e-05	386	6.26e-05
308	9.68e-06	348	5.37e-05	388	6.72e-05
310	1.34e-05	350	5.59e-05	390	7.57e-05
312	1.75e-05	352	5.89e-05	392	7.16e-05
314	2.13e-05	354	6.13e-05	394	6.55e-05
316	2.43e-05	356	6.06e-05	396	6.81e-05
318	2.79e-05	358	5.38e-05	398	8.01e-05
				400	1.01e-04

Note: The intervals in Table II are in 2 nm. For 5 nm UV transmission data use the interpolated data between those ending in a "4" and a "6."

^a Sayre, R. M., et al., "Spectral Comparison of Solar Simulators and Sunlight," *Photodermatol Photoimmunol. Photomed.*, 7, 159-165 (1990).

$$UPF = \frac{\sum_{280}^{400} E_{\lambda} \times S_{\lambda} \times \Delta\lambda}{\sum_{280}^{400} E_{\lambda} \times S_{\lambda} \times T_{\lambda} \times \Delta\lambda} \quad (1)$$

where:

- E_{λ} = relative erythral spectral effectiveness (see Table I)
- S_{λ} = solar spectral irradiance (see Table II)
- T_{λ} = average spectral transmittance of the specimen (measured)
- $\Delta\lambda$ = measured wavelength interval (nm)

NOTE: Although integration is indicated from 280 nm to the stated wavelengths, little or no contribution will occur in the 280-290 nm region.

11.3 Calculate the average A-range ultraviolet (UV-A) transmittance using Equation 2:

$$T(UV-A)_{AV} = \frac{\sum_{315}^{400} T_{\lambda} \times \Delta\lambda}{\sum_{315}^{400} \Delta\lambda} \quad (2)$$

11.4 Calculate the average B-range ultraviolet (UV-B) transmittance using Equation 3:

$$T(UV-B)_{AV} = \frac{\sum_{280}^{315} T_{\lambda} \times \Delta\lambda}{\sum_{280}^{315} \Delta\lambda} \quad (3)$$

11.5 Calculate the percent blocking for UV-A and for UV-B using Equation 4 and Equation 5:

$$= 100\% - T(UV-A) \quad (4)$$

$$= 100\% - T(UV-B) \quad (5)$$

where:

$T(UV-A)$ or $T(UV-B)$ is expressed as a percentage.

12. Report

12.1 Report the following by sample identification:

- 12.1.1 The ultraviolet protection factor, UPF
- 12.1.2 The UV-A transmittance, $T(UV-A)$
- 12.1.3 The UV-B transmittance, $T(UV-B)$
- 12.1.4 The percent blocking (UV-A)
- 12.1.5 The percent blocking (UV-B)
- 12.1.6 The actual percent wet pick-up if other than 150%.

13. Precision and Bias

13.1 *Precision*. In March 1998, an ul-

traviolet transmittance scan was performed on the same specimen of 100% polyester woven fabric fifteen (15) times and the UPF calculated according to this procedure. The average UPF was 19.41 and the standard deviation was 0.18. *Between-laboratory* precision has not been established for this test method. Until such precision information is available, users of the method should use standard statistical techniques in making any comparison of test results for *between-laboratory* averages.

13.2 *Bias*. Transmittance or blocking of erythemally weighted ultraviolet radiation through fabrics can be defined only in terms of a test method. There is no independent method for determining the true value. As a means of estimating this property, the method has no known bias.

14. References

- 14.1 ASTM D 1776, Standard Practice for Conditioning and Testing Textiles (see 15.3).
- 14.2 ASTM E 179, Guide for Selection of Geometric Conditions for Measurement of Reflection and Transmission Properties of Materials (see 15.3).
- 14.3 ASTM E 275, Practice for Describing and Measuring Performance of Ultraviolet, Visible and Near-Infrared Spectrophotometers (see 15.3)
- 14.4 ASTM G 159, Standard Tables for References Solar Spectral Irradiance at Air Mass 1.5: Direct Normal and Hemispherical for a 37° Tilted Surface (see 15.3).
- 14.5 ASTM E 1247, Test Method for Identifying Fluorescence in Object-Color Specimens by Spectrophotometry (see 15.3).
- 14.6 ASTM E 1348, Test Method for Transmittance and Color by Spectrophotometry using Hemispherical Geometry (see 15.3).

15. Notes

- 15.1 Spectrophotometers or spectroradiometers that meet the requirements of this test method are available from a large number of manufacturers.
- 15.2 Available from Schott Inc., 400 York Ave., Duryea PA 18642; tel: 717/457-4485.
- 15.3 Available from ASTM, 100 Barr Harbor Dr., West Conshohocken PA 19428-2959; tel: 610/832-9500; fax: 610/832-9555.
- 15.4 Commission International de L'Éclairage (CIE), Bureau Central de la CIE, Paris, France.
- 15.5 Available from AATCC, P.O. Box 12215, Research Triangle Park NC 27709; tel: 919/549-8141; fax: 919/549-8933; e-mail: orders@aatcc.org.

Appendix A

Spectrophotometer or Spectroradiometer Specifications

A1. The integrating sphere surface is internally coated or constructed using a material that is both diffuse and highly

reflecting in the ultraviolet region. The total surface area consumed by all port openings required shall not exceed 3% of the total surface area of the integrating sphere.

A2. Illumination and viewing geometries.

A2.1 Directional illumination/hemispherical collection (0/T). In this geometry the specimen is illuminated with an unidirectional beam whose axis is not greater than 0.14 rad (8°) from the surface normal of the sample. Any ray of this beam shall not exceed 0.09 rad (5°) from the beam axis. The cross-sectional area of the illuminating beam shall be at least 10 times the dimension of the largest hole in the test material. The total flux transmitted by the specimen is collected by the integrating sphere.

A2.2 Hemispherical illumination/directional viewing (T/0). In this geometry the specimen is illuminated by an internally illuminated integrating sphere. The specimen is viewed unidirectionally with an axis not greater than 0.14 rad (8°) from the surface normal of the sample. Any ray of this beam shall not exceed 0.09 rad (5°) from the beam axis.

The cross-sectional area of the viewing beam shall be at least 10 times the dimension of the largest hole in the test material.

A2.3 Sample substitution errors. Integrating spheres can experience "sample substitution" error due to contributions of the reflectance of the specimen on the internal illumination of the sphere. The error can be eliminated in either geometry by use of a separate reference beam that traverses its own port opening in the sphere. The reference beam impinges on either a portion of the sphere wall or a reference material mounted at a diametrically opposed port opening.

A3. Spectral requirements. The spectrophotometer or spectroradiometer shall have a spectral bandpass of 5 nm or less over the spectral range of 280 nm (or less) to 400 nm (or more). The measured wavelength interval over this spectral range should not be greater than 5 nm.

A4. Stray radiation. The contribution of stray radiation within the instrument, including that due to sample fluorescence, shall produce an error of less than 0.005 in the value of spectral transmittance being measured.

A5. Sample fluorescence. The contribution of sample fluorescence on spectral transmittance measurements on certain dyes and whitening agents present in fabrics that may fluoresce could result in artificially high values of spectral transmittance.

A5.1 Monochromatic illumination. In spectrophotometers where the monochromator precedes the specimen within the optical path, the artificially high val-

ues of transmittance appear at the excitation wavelengths of the fluorescing agent. This includes nearly all wavelengths in the UVR spectral region. The error due to the fluorescence can be removed by placing a UV transmitting, visible blocking filter after the sample. A Schott Glass UG11 filter has been found to be satisfactory. However, the decrease in transmission of the filter with increasing wavelength may reduce the usefulness of the long wavelength UVA

measurement.

A5.2 Polychromatic illumination. In spectrophotometers and spectroradiometers where the illumination is polychromatic and the monochromator follows the specimen in the optical path, the artificially high values of transmittance appear at the emission wavelengths of the fluorescing agent. The effects of fluorescence are, therefore, eliminated at most UVR wavelengths. The use of an illuminating light source

that conforms to the spectral distribution requirements for solar simulators will most accurately include the contribution of sample fluorescence to the long wavelength UVA measurement. However, because the fluorescent component does not contribute to the UPF, the spectral distribution of the source is irrelevant, so long as it provides sufficient energy to cover the spectral range of interest to acceptable signal to noise ratios in the spectral data.

Dusting Behavior of Dyes: Determination of

Developed in 1998 by AATCC Committee RA87; reaffirmed 1999, 2000, 2005. Based on and equivalent to ISO 105-Z05.

1. Purpose and Scope

1.1 This test method provides a means to assess the dusting behavior of dyes.

2. Principle

2.1 Dust is generated from a dye sample by means of a dust-generating device, extracted from the dust-bearing air by vacuum and conveyed to a detection point, where the amount of dust generated is estimated visually or determined quantitatively by a gravimetric or photometric option.

3. Terminology

3.1 **dust**, *n.*—fine particles of solid material dispersed in a gas.

4. Safety Precautions

NOTE: These safety precautions are for information purposes only. The precautions are ancillary to the testing procedures and are not intended to be all inclusive. It is the user's responsibility to use safe and proper techniques in handling materials in this test method. Manufacturers MUST be consulted for specific details such as material safety data sheets and other manufacturer's recommendations. All OSHA standards and rules must also be consulted and followed.

4.1 Follow good laboratory practices. Wear safety glasses in all laboratory areas.

4.2 An eyewash safety shower should be located nearby and a self-contained breathing apparatus should be readily available for emergency use.

5. Uses and Limitations

5.1 Dyestuff dust is formed during handling operations such as dispensing, transferring, sprinkling, etc.

5.2 The dustiness of dyestuffs is an important characteristic when considering aspects of hygiene, health and safety in the dyestuff consuming industry. It is important, therefore, that a reliable and reproducible method exists to measure this property.

5.3 Although other methods of dust measurements exist, the method given in this test procedure is both more represen-

tative of and comparable with actual practice when handling dyestuffs. With respect to a comparison of dyestuffs or the reliability limits, it should be understood that the resulting value is not a specific value like density.

5.4 Solid dyes are sold in different physical forms (powdered, granulated, etc.). The particle-size distribution of commercial products varies considerably. The mean particle diameter may be less than 50 μm or as much as several millimeters. The range of particle-size distribution of a solid dye may also be narrow or wide.

5.5 The particle-size distribution of dyestuff dust is largely independent of the physical form of the dyestuff. Two typical particle-size distributions for dyestuff dust are shown in Fig. 1.

6. Apparatus and Materials

6.1 Balance, accurate to ± 0.1 g, for weighing the dye.

6.2 Dust-generating device, with filter holder and connecting joints, and incorporating the following additional components (see Figs. 2 and 3, and 13.1 and 13.2).

6.2.1 Filter, white, diameter 50 ± 2 mm, capable of trapping the dust quantitatively (pore size $< 5 \mu\text{m}$), for gravimetric and photometric options made of cellulose acetate nitrate. For the visual option, suitable glass fiber filters can be used.

6.2.2 Vacuum pump with a suction capacity of at least 20 L/min.

6.2.3 Regulator for adjusting the air flow rate.

6.2.4 Flowmeter capable of monitoring the air flow rate between 10-20 L/min.

6.2.5 Timer for opening the slide valve to start suction, and for timing the period of suction.

6.3 Dust assessment apparatus.

6.3.1 For visual option, Gray Scale for Staining (see 13.3 and 13.4).

6.3.2 For gravimetric option, analytical balance.

6.3.3 For photometric option, photometer.

6.4 Analytical balance, accurate to ± 0.01 mg, for weighing the dust collected on the filter (see 6.2.1) (gravimetric assessment option), and/or photometer, for extinction measurement of the dust collected and dissolved in a suitable solvent (photometric assessment option).

6.5 Cleaning device; e.g., brush or vacuum cleaner, for cleaning the apparatus.

6.6 Tweezers for removing filter paper from the holder after dust generation.

7. Procedure

7.1 Place the filter holder with the filter (see 6.2.1) in the dust generating apparatus (see 6.2) and close it to give an airtight fit. If the gravimetric option of assessment is used, condition and weigh the filter before insertion into the filter holder.

7.2 Using the balance (see 6.1), carefully weigh 10.0 ± 0.1 g of the dye and place it in the hopper at the top of the apparatus. Start the timer (see 6.2.5) to open the slide valve with a sudden action, allowing the dye to drop down through the tube into the dust chamber below.

7.3 Five seconds after the slide has opened, apply a vacuum to extract the dust from the chamber for collection on the filter (see 6.2.1) under the following conditions:

7.3.1 Air flow rate: 15 L/min.

7.3.2 Extraction time: 120 s (starting 5 s after dye has dropped).

7.3.3 Height of fall: 815 ± 5 mm.

7.4 Using tweezers (see 6.6), carefully remove the dust-laden filter from the holder and evaluate it by one of the options given in Section 8.

7.5 Clean the equipment thoroughly (see 6.5) after each test. If the equipment is wet-cleaned, take particular care that it is dried thoroughly.

8. Assessment of Filter

8.1 Visual option. Compare the dust-laden filter visually with the Gray Scale for Staining (see 6.3.1) rate the filter using Table 1 of Evaluation Procedure 2. Half-grades may be used.

Table 1—Dust Assessment Rating Scale

Grade	Description
5	No dust
4	Slightly dusty
3	Moderately dusty
2	Dusty
1	Very dusty

8.2 Gravimetric option. Weigh the dust-laden filter on the analytical balance (see 6.4) to the nearest 0.01 mg. Since with low-dusting products the mass of dust is very small (< 1 mg), considerable errors are to be expected with the gravimetric

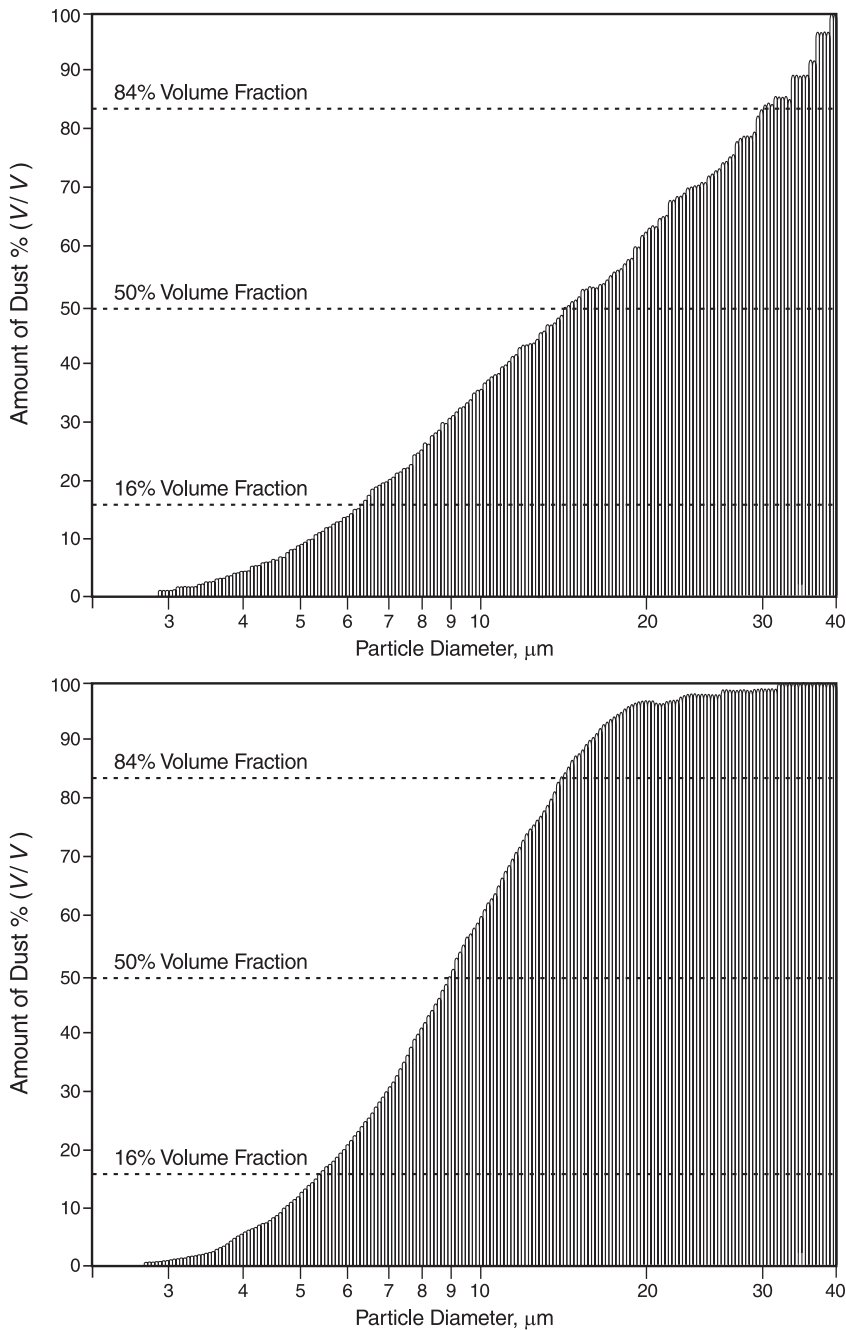

NOTE — The x-axis of both graphs has a logarithmic scale.

Fig. 1—Typical graphical representation of the amount of dust (by volume) as a function of the dust-particle diameter.

option. In such cases preference should be given to photometric measurement.

8.3 Photometric option. For photometric measurement of the amount of dust, dissolve the dyestuff by shaking well the dust-laden filter in a suitable solvent at room temperature. When a clear solution has formed, measure the transmission with a photometer and read the corresponding amount of dust off a previously prepared calibration graph (see 12.1).

9. Evaluation

9.1 The generation and detection of dust depend on a great number of parameters. For this reason, the determination of the amount of dust yields results which are valid for the specified test conditions. This means that a direct comparison of either the visual or the quantitative results of dust behavior with results from other test methods is not possible. However,

the relative order of results of a set of test specimens from one test method is likely to be comparable with that from other test methods.

9.2 Visual option. Express the results of the visual option as the Gray Scale rating obtained in 8.1.

9.2.1 A quantitative determination of the amount of dust produced by a dye is not possible by the visual option. The main reasons for this are different particle size distributions, particle sizes and shades of the dust in each case.

9.2.2 Visual assessment is subjective and depends on factors such as the experience of the examiner, the hue of the layer of dust and the nature of the filter surface (smooth or rough). Variations of up to half a grading unit are inherent in this system. Empirically, the total error under reproducibility conditions (same apparatus and laboratory) does not exceed this value.

9.3 Gravimetric and Photometric options.

9.3.1 Record the results obtained from 8.2 and 8.3 in milligrams of dyestuff dust collected.

9.3.2 In both of the quantitative options (gravimetric and photometric), the determination is based on the amount of dust trapped on the filter. Because the amount of dust is measured in milligrams, in the gravimetric option, variations in the conditioning of the filter and electrostatic influences can lead to substantial errors. If the amount of dust is determined by photometry, care must be taken that the transmission is measured on clear solutions. According to the experience of various laboratories, a reproducibility of about 10% (coefficient of variation) can be attained under favorable conditions.

9.4 Scatter of results. In some cases, scattering of the results may occur. The main causes of this are:

9.4.1 Factors specific to the apparatus:

9.4.1.1 The air flow rate is incorrectly adjusted.

9.4.1.2 The air flow rate through the apparatus is not constant, or the vacuum is incorrectly applied.

9.4.1.3 The timing control is imprecise.

9.4.2 External factors:

9.4.2.1 Humidity.

9.4.2.2 Electrostatic charges inside the vertical tube and the dust chamber.

9.4.2.3 Inhomogeneous distribution of the dust within the sample.

10. Report

10.1 The report should include the following information:

10.1.1 A full description of the sample tested.

10.1.2 The mass of the test specimen.

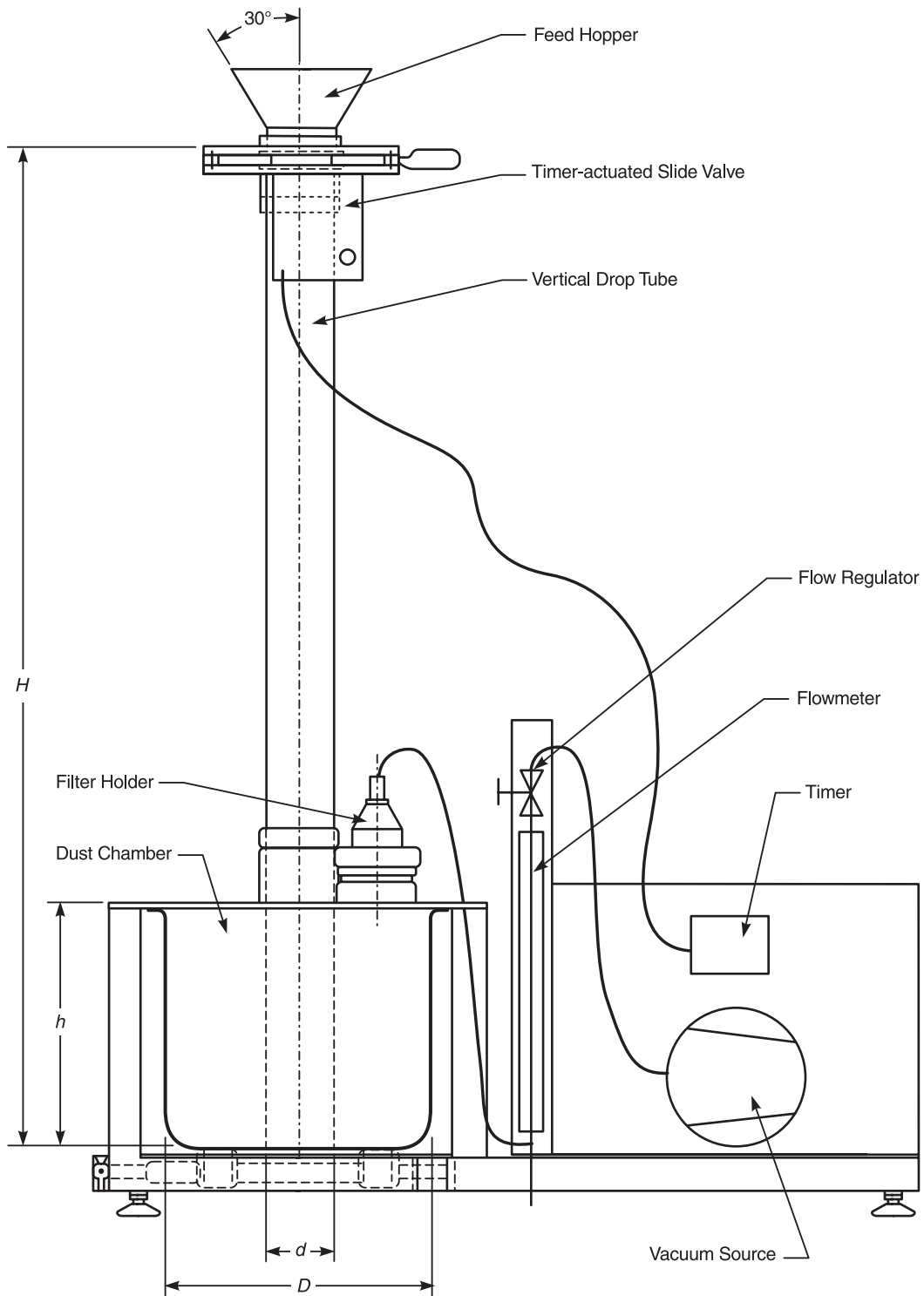

H	Total fall height ¹	815 mm	± 5 mm
h	Dust chamber height	195 mm	± 5 mm
D	Dust chamber diameter	Ø 210 mm	± 5 mm
d	Drop tube diameter	Ø 47 mm	± 1 mm

¹Total fall height is measured from the top side of the slide valve plate to the inside face of the dust chamber.

Fig. 2—Apparatus for dust determination.

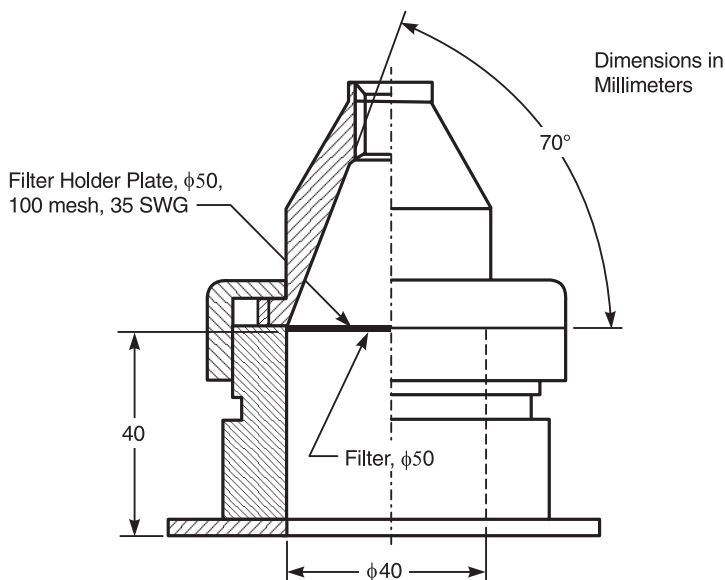

Fig. 3—Filter holder.

10.1.3 The assessment option used and the result obtained, expressed as in 9.2 and 9.3.

10.1.4 Details of any deviation from the procedure.

11. Precision and Bias

11.1 *Summary.* The precision is based on data for the gravimetric option contained in Annex A of ISO 105-Z05:1996, Determination of the dusting behaviour of dyes. Four laboratories participated in

the study, testing three dyes at two time periods at 10 determinations each period. Three laboratories were judged to be at a similar performance level. Testing at the two time periods showed no effect. All of the data from the three laboratories were included in the analysis, using analysis of variance.

11.2 *Precision.* Because of the limited test plan, this is included as an interim precision statement.

11.2.1 Components of variance are given as standard deviations, with units

of mg/filter, and as variances, with units of $(\text{mg}/\text{filter})^2$, in the following table:

Components of Variance	Std. Deviation	Variance
Between-Laboratory	0	0
Laboratory X Dye Interaction	0.187	0.035
Within-Laboratory	0.276	0.076

11.2.2 *Critical Differences.* A difference between two averages, under the appropriate precision category, is statistically significant at the 95% confidence level, if the difference is equal to or greater than the table value shown (see Table II).

Most comparisons are likely to be under the single dye category. However, if comparisons are made across dyes, use the multiple dye columns which include the effect of the interaction component of variance.

11.3 *Bias.* This test method has no known bias. There is no referee method for determining a true value for the dusting behavior of dyes by which bias may be established.

12. References

12.1 AATCC Method 182, Relative Color Strength of Dyes in Solution (see 13.3).

13. Notes

13.1 Available from Roaches International, UpperHulme, Leek, Staffordshire UK; tel: 44 01538 300425; fax: 44 01538 300364.

13.2 Instead of a filter and filter holder, other dust-detection devices may be fitted to the apparatus, such as an impactor or an optical particle counter.

13.3 Available from AATCC, P.O. Box 12215, Research Triangle Park NC 27709; tel: 919/549-8141; fax: 919/549-8933; e-mail: orders@aatcc.org.

13.4 It is also possible to carry out a visual assessment of colorless solid materials. However, special care has to be exercised in such cases. Black filters may be helpful, but require separate preliminary trials. It is preferable to use the gravimetric or photometric option.

Table II

N	Single Dye Comparisons		Multiple Dye Comparisons	
	Within-Laboratory	Between-Laboratory	Within-Laboratory	Between-Laboratory
5	0.34	0.34	0.62	0.62
10	0.24	0.24	0.57	0.57
15	0.20	0.20	0.56	0.56

Chelating Agents: Percent Content in Hydrogen Peroxide Bleach Baths; Copper PAN Indicator Method

Developed in 1998 by AATCC Committee RA90; reaffirmed 1999, 2000.

1. Purpose and Scope

1.1 This test method measures the chelating agent content in a hydrogen peroxide bleach solution.

1.2 The method is designed to permit routine or periodic titration of the peroxide saturator section of a plant preparation range, or other prepared peroxide bleach solutions, to determine the concentration of chelating agent present.

1.3 The method is restricted to chelating agents based on ethylenediaminetetraacetic acid (EDTA), N-hydroxyethyl-ethylenediaminetriacetic acid (HEDTA), and diethylenetriaminepentaacetic acid (DTPA). This includes any proprietary products (referred to herein as "product") containing possible multiple ingredients, one or more of which may be chelating agents.

2. Principle

2.1 The percent chelating agent or product in the hydrogen peroxide bleach bath is determined in two steps: first, a direct titration of the chelating agent or product using a known concentration of copper sulfate in the presence of an indicator (PAN, 1-(2-pyridylazo)-2-naphthol), and second, a similar titration of the bleach solution containing the chelating agent using a more dilute concentration of the copper sulfate as the titrant.

3. Terminology

3.1 **chelating agent**, *n.*—*in textile chemistry*, a chemical capable of deactivating metal ions by formation of a water soluble complex. SYN. *sequestering agent*.

3.2 **copper chelation value (CuCV)**, *n.*—the milligrams of copper sulfate pentahydrate chelated by one gram of a chelating agent or product containing a chelating agent.

4. Safety Precautions

NOTE: These safety precautions are for information purposes only. The precautions are ancillary to the testing procedures and are not intended to be all inclusive. It is the user's responsibility to use safe and proper techniques in handling

materials in this test method. Manufacturers MUST be consulted for specific details such as material safety data sheets and other manufacturer's recommendations. All OSHA standards and rules must also be consulted and followed.

4.1 Good laboratory practices should be followed. Wear safety glasses in all laboratory areas.

4.2 All chemicals should be handled with care. Many of the chemicals used in this procedure are corrosive or a strong irritant.

4.3 In preparing, dispensing and handling sulfuric acid (98%), glacial acetic acid and sodium hydroxide use chemical goggles, or face shield, impervious gloves and an impervious apron. Concentrated acids should be handled only in an adequately ventilated hood. CAUTION: Always add acid to water.

4.4 Methanol is a flammable liquid and should be stored in the laboratory only in small containers away from heat, open flame and sparks.

4.5 An eyewash/safety shower should be located nearby and a high efficiency particulate respirator with organic vapor cartridges and a full face piece should be readily available for emergency use.

4.6 Exposure to chemicals used in this procedure must be controlled at or below levels set by governmental authorities (e.g., Occupational Safety and Health Administration's [OSHA] permissible exposure limits [PEL] as found in 29 CFR 1910.1000 of January 1, 1989). In addition, the American Conference of Governmental Industrial Hygienists (ACGIH) Threshold Limit Values (TLVs) comprised of time weighted averages (TLV-TWA), short term exposure limits (TLV-STEL) and ceiling limits (TLV-C) are recommended as a general guide for air contaminant exposure which should be met (see 13.1).

5. Uses and Limitations

5.1 Results may be affected by any of the following:

5.1.1 Pre-chelation of iron or copper ions contained in the bleach solution will reduce the apparent, calculated concentration of chelating agent originally present in the bath.

5.1.2 Oxidation of uncombined chelating agent by hydrogen peroxide will reduce the apparent concentration in the bleach bath.

5.1.3 Cyanide ions, ammonia, and most amines will form molecular compounds with copper ions without affecting the PAN indicator, resulting in false positive results.

5.2 The percent chelating agent in the bleach bath will not be affected by changes in the active ingredient content of the chelating agent or product.

5.2.1 AATCC Method 168, Chelating Agents: Active Ingredient Content of Polyaminopolycarboxylic Acids, should be conducted on each new lot of the chelating agent or product to determine if the active ingredient content has changed.

5.2.2 The copper chelation value (CuCV) determined in this method is a direct indication of the active ingredient content of the chelating agent or product and can be monitored for this purpose.

6. Reagents

6.1 The reagents used in this method should be ACS reagent grade quality.

6.1.1 Acetic acid, glacial (CH₃COOH)

6.1.2 Copper sulfate pentahydrate (CuSO₄ · 5H₂O)

6.1.3 Methanol (CH₃OH)

6.1.4 PAN, 1-(2-pyridylazo)-2-naphthol (C₁₅H₁₁ON₃)

6.1.5 Sodium acetate trihydrate (NaC₂H₃O₂ · 3H₂O)

6.1.6 Sodium hydroxide, pellets (NaOH)

6.1.7 Sulfuric acid, 98% (H₂SO₄)

7. Sampling

7.1 Test two specimens of the chelating agent or product and two specimens of the bleach bath.

8. Preparation of Reagents

8.1 Reagent A (12.500 g/L copper sulfate). Dissolve 12.500 g ± 0.002 g of copper sulfate pentahydrate in distilled water and dilute to 1 L in a volumetric flask.

8.2 Reagent B (2.500 g/L copper sulfate). Transfer 200 mL of Reagent A to a 1 L volumetric flask and dilute to volume with distilled water.

8.3 PAN indicator. Dissolve 0.025 ± 0.001 g of PAN in 50.0 mL of methanol. Store in a stoppered bottle in a refrigerator. Prepare fresh weekly.

8.4 Sodium acetate buffer solution. Dissolve 34.0 ± 0.1 g of sodium acetate

trihydrate in 500 ± 1 mL of distilled water and add 15.0 ± 0.1 mL of glacial acetic acid. Mix well and store in a closed container.

8.5 Sodium hydroxide (20% by volume). Dissolve 200 ± 1 g of sodium hydroxide in 800 mL of distilled water with stirring. Cool, transfer to a 1 L volumetric flask and adjust to volume with distilled water.

8.6 Sulfuric acid (20% by volume). Slowly add 200 ± 1 g of sulfuric acid to 500 mL of distilled water. Cool, transfer to a 1 L volumetric flask and adjust to volume with distilled water.

9. Procedure

9.1 Chelation value of chelating agent or product.

9.1.1 Weigh a 0.9-1.1 g specimen of chelating agent or product to nearest 0.01 g. Dilute to 75 mL with distilled water.

9.1.2 Add 25 mL of sodium acetate buffer solution and adjust the pH to 4.5-5.5 with glacial acetic acid or 20% sodium hydroxide as required.

9.1.3 Add 1 mL of PAN indicator and titrate to a permanent purple end point with Reagent A. Record the volume used to the nearest 0.01 mL and use this volume in Equation 1 (see 13.2).

9.2 Chelating agent in bleach bath.

9.2.1 Weigh a 90-110 g specimen of the hydrogen peroxide bleach solution to the nearest 0.01 g. If the specimen is taken from the saturator, ensure that it is free of debris and foam.

9.2.2 Adjust the pH to 7.0-9.0 with 20% sulfuric acid.

9.2.3 Add 35 mL sodium acetate buffer solution. Adjust the pH to 4.5-5.5 with glacial acetic acid or 20% sodium hydroxide if necessary.

9.2.4 Add 1 mL of PAN indicator and titrate to a permanent purple end point with Reagent B. Record the volume used to nearest 0.01 mL and use this volume in Equation 2 (see 13.2).

10. Calculations

10.1 Calculate the copper chelation value of the chelating agent or product to two decimal places using Equation 1:

$$\text{CuCV} = 12.5 (V)/W \quad (1)$$

where:

CuCV = Copper chelation value
 V = volume of Reagent A used, mL
 W = weight specimen, g

10.2 Calculate the average copper chelation value.

10.3 Calculate the chelating agent content in the bleach bath to the nearest 0.01% using Equation 2:

$$\text{CA} = 2.5(100)(V_2)/(W_2)(S) \quad (2)$$

where:

CA = chelating agent content, %
 V_2 = volume Reagent B used, mL
 W_2 = weight of specimen, g
 S = average CuCV (from 10.2)

10.4 Calculate the average percent chelating agent content in the bleach bath.

11. Report

11.1 Report the average percent chelating agent content.

12. Precision and Bias

12.1 Precision.

12.1.1 In 1990, an interlaboratory study was completed which included seven laboratories, one operator in each, running two determinations per sample on three samples in Step 9.1 of the procedure, and running two determinations per bath on three baths for Step 9.2 of the procedure. No prior assessment was made of the relative level of the participating laboratories in performance of the test method. Results from one lab were not included in the analysis.

12.1.2 Analysis of the data sets yielded components of variance and critical differences as displayed in Tables I, II and III. Differences between two averages of N determinations, for the appropriate precision parameter, should reach or exceed the table value to be statistically significant at the 95% confidence level.

12.2 Bias.

12.2.1 The values for CuCV can only be defined in terms of a test method. There is no independent, referee method for determining the true values. The method has no known bias.

Table I—Components of Variance

Component	Variance Step 9.1	Variance Step 9.2
Laboratory V(L)	2.61	0.000111
Interaction V(SL)	0.76	0.000157
Within V	0.81	0.000030

Table II—Chelating Agent or Product Critical Differences (95% Confidence)

Det. in Avg (N)	Within Laboratory	Between Laboratory
(Single Sample Comparisons)		
1	2.49	5.13
2	1.76	4.81
3	1.44	4.71
(Multiple Sample Comparisons)		
1	2.49	5.67
2	1.76	5.39
3	1.44	5.29

Table III—Bleach Bath Critical Differences (95% Confidence)

Det. in Avg (N)	Within Laboratory	Between Laboratory
(Single Bath Comparisons)		
1	0.015	0.033
2	0.011	0.031
3	0.009	0.031
(Multiple Bath Comparisons)		
1	0.015	0.048
2	0.011	0.047
3	0.009	0.046

13. Notes

13.1 Available from Publications Office, ACGIH, Kemper Woods Center, 1330 Kemper Meadow Drive, Cincinnati OH 45240; tel: 513/742-2020.

13.2 A 12.5 g/L solution of copper sulfate (Reagent A) is used to titrate the chelating agent product, whereas a 2.5 g/L solution of copper sulfate (Reagent B) is used for greater accuracy to titrate the more dilute chelating agent contained in the peroxide bleach solution.

Weather Resistance: UV Light and Moisture Exposure

Developed in 1999 by AATCC Committee RA64; revised 2000; editorially revised and reaffirmed 2001.

1. Purpose and Scope

1.1 This test method provides a procedure for the exposure of textile materials of all kinds, including coated fabrics and products made thereof, in a laboratory artificial weathering exposure apparatus employing fluorescent UV lamps as a light source and using condensing humidity and/or water spray for wetting.

2. Principle

2.1 Specimens are exposed to a fluorescent UV light source and to periodic wetting under controlled conditions. Resistance to degradation is rated in terms of a comparison standard and the exposure criteria, percent loss in strength or percent residual strength (breaking or bursting as appropriate) and/or color change of the material when evaluated under standard textile conditions.

3. Terminology

3.1 **breaking strength**, n.—the maximum force applied to a specimen in a tensile test carried to rupture.

3.2 **bursting strength**, n.—the force or pressure required to rupture a textile by distending it with a force, applied at right angles to the plane of the fabric, under specified conditions.

3.3 **fluorescent UV lamp**, n.—a lamp in which radiation at 254 nm from a low-pressure mercury arc is transformed to longer wavelength UV by a phosphor.

3.4 **irradiance**, n.—radiant power per unit area as a function of wavelength expressed as watts per square meter, W/m².

3.5 **radiant energy**, n.—energy traveling through space in the form of photons or electromagnetic waves of various lengths.

3.6 **spectral energy distribution**, n.—the variation of energy due to the source over the wavelength span of the emitted radiation.

3.7 **standard atmosphere for testing textiles**, n.—air maintained at $21 \pm 1^\circ\text{C}$ and $65 \pm 2\%$ relative humidity.

3.8 **ultraviolet radiation**, n.—radiant energy for which the wavelengths of the monochromatic components are smaller than those for visible radiation and more than about 100 nm.

NOTE: The limits of the spectral range

of ultraviolet radiation are not well defined and may vary according to the user. Committee E-2.1.2 of the CIE distinguishes in the spectral range between 400 and 100 nm:

UV-A	315-400 nm
UV-B	280-315 nm
UV-R	280-400 nm

3.9 **UV-A Type Fluorescent UV lamp**, n.—a fluorescent UV lamp where radiant emission below 300 nm is less than 2% of its total light output.

3.10 **UV-B Type Fluorescent UV lamp**, n.—a fluorescent UV lamp where radiant emission below 300 nm is more than 10% of its total light output.

3.11 **weather**, n.—climatic conditions at a given geographic location, including such factors as sunlight, rain, humidity and temperature.

3.12 **weather resistance**, n.—ability of a material to resist degradation of its properties when exposed to climatic conditions.

4. Safety Precautions

NOTE: These safety precautions are for information purposes only. The precautions are ancillary to the testing procedures and are not intended to be all inclusive. It is the user's responsibility to use safe and proper techniques in handling materials in this test method. Manufacturers MUST be consulted for specific details such as material safety data sheets and other manufacturer's recommendations. All OSHA standards and rules must also be consulted and followed.

4.1 Good laboratory practices should be followed. Wear safety glasses in all laboratory areas.

4.2 Do not operate the test equipment until the manufacturer's operating instructions have been read and understood. It is the responsibility of whoever operates the test equipment to conform to the manufacturer's directions for safe operation.

4.3 The test equipment contains high intensity lamps. Do not look directly at the light source. The door to the test chamber must be kept closed when the equipment is in operation.

4.4 Before servicing the light sources, allow 30 min for cool-down after the lamp operation has been terminated.

4.5 When servicing the test equipment, shut off both the "off" switch on the front panel and the main power disconnect switch. When equipped, ensure that the main power light on the machine front

panel goes out.

5. Uses and Limitations

5.1 The use of this procedure is intended to simulate the deterioration caused by the UV energy in sunlight and water. Exposures are not intended to simulate the deterioration caused by localized weather phenomena, such as atmospheric pollution, biological attack and salt water exposure.

5.2 Cautions. Variation in results may be expected when operating conditions are varied within the accepted limits of this procedure. Therefore, no reference shall be made to results from the use of this procedure unless accompanied by a report detailing the specific operating conditions in conformance with the section on Report.

5.3 Results obtained from this procedure can be used to compare the relative durability of materials subjected to the specific test cycle used. Comparison of results from specimens exposed in different types of apparatus should not be made unless correlation has been established among devices for the material to be tested. Variations in results may be expected when operating conditions vary within the limits of this procedure. Because of the variability in results obtained using this practice and the variability in results from exterior exposures, use of a single "acceleration factor" that relates hours of an accelerated exposure to a specific period of outdoor exposure is not recommended. Because of possible variations in results, no reference should be made to results obtained from tests conducted in the apparatus using this procedure unless accompanied by the information required in the section on Report.

5.4 There are a number of factors that may decrease the degree of correlation between accelerated tests using laboratory light sources and actual use exposures.

5.4.1 Differences in the spectral distribution between the laboratory light source and sunlight.

5.4.2 Shorter than normal wavelength exposures are often used to obtain faster failure rates in laboratory accelerated exposure tests. For outdoor exposures, the cut-on for short wavelength UV radiation is generally considered to be 300 nm. Exposures to UV radiation of wavelengths less than 300 nm, may produce degradation reactions, which do not occur when the material is used outdoors. If a laboratory light source used in an accelerated test contains UV radiation of wave-

lengths shorter than that found in the actual use condition, the mechanism of degradation and stability ranking of materials can be dramatically different in the accelerated test.

5.5 It may not be necessary to simulate daylight over the entire spectrum, if radiation in a specific region is known to produce the type of degradation of interest in the materials being tested and does not alter stability ranking of materials. Laboratory light sources, which have a very strong emission in a narrow band relative to the rest of the ultraviolet or visible spectrum, however, may cause a particular reaction to be favored relative to others which may be very important. This type of light source also may not produce changes caused in exposures to daylight. Exposures to light sources, which only produce ultraviolet radiation may not produce color fade caused by visible radiation, and may cause polymer yellowing that is more pronounced than that produced in exposures to daylight.

6. Apparatus (See 17.1)

6.1 Test chamber (see 17.2).

6.2 UV-A type fluorescent UV lamp (see 17.7).

6.3 Moisture system.

6.3.1 Condensation. The moisture system may be used to generate either condensation or water spray or both (see 17.7).

6.3.2 Water spray. The test chamber may be equipped with a means to introduce intermittent water spray onto the test specimens under specified conditions. The spray shall be uniformly distributed over the samples. The spray system shall be made from corrosion resistant materials that do not contaminate the water employed.

6.4 Black panel thermometer (see 17.8 and 17.9).

6.5 Specimen holders (see 17.10).

6.6 Test chamber location (see 17.11).

7. Test Samples

7.1 Number of Specimens. Replicate specimens of the material to be tested and a comparable number of the standard for comparison should be used as required to ensure accuracy. It is recommended that at least three replicates of each material evaluated be exposed in each test to allow for statistical evaluation of results.

Expose a sufficient number of specimens so that the expected test result is not more than 5% of the average above or below the true average of the lot at the 95% probability level. Determine the number of specimens using standard deviation with one-sided limits as directed in ASTM Practice D 2905.

7.2 Specimen Dimensions. Certain materials may exhibit a dimensional change

as a result of exposure. The test equipment manufacturer, physical test apparatus and number of replicate specimens required will affect the needed specimen dimension. The test procedures which will be used to assess the change in properties should be reviewed to ensure that specimen size is appropriate for performing the subsequence procedures.

Cut strips of fabric at least 102×152 mm with the longer dimension parallel to the warp of machine direction, unless otherwise specified, for the following tests:

7.2.1 Bursting Strength (Ball Burst).

7.2.2 Breaking Strength (Grab Tensile).

7.2.3 Color Change.

7.2.4 When required to prevent raveling, the specimens may be edged using a flexible epoxy resin or similar material.

7.2.5 Label each specimen for identification using material resistant to the environment encountered during the test.

8. Test Cycle Determination

8.1 The test cycle is best determined by the influencing factors of the end use, in particular, the climatic conditions. Not all materials are affected equally by the same environment. Results obtained by the use of any one test cycle may not be representative of those of any other test cycles or any outdoor weathering test. Any acceleration factor derived for one geographic location does not necessarily apply to any other geographic location. However, certain test cycles are suggested to group similar climates with respect to the test cycle.

8.2 The nature of the test material contributes to the selection of the appropriate test cycle with respect to UV exposure, wetting, wet time and temperature. The following test cycles options have been used for textile materials.

8.2.1 Option 1, General Applications: 8 h UV at an irradiance of 0.77 W/m^2 @ 340 nm at 60°C followed by 4 h condensation at 50°C . This option is used for general applications such as outdoor furniture fabrics, tent material, etc.

8.2.2 Option 2, Thermal Shock Applications: 8 h UV at an irradiance of 0.77 W/m^2 @ 340 nm at 60°C ; followed by 0.25 h water spray; followed by 3.75 h condensation at 50°C . This option has been used for architectural and other applications where thermal shock may be an issue.

8.2.3 Option 3, Automotive Exterior: 8 h UV at an irradiance of 0.72 W/m^2 @ 340 nm at 70°C followed by 4 h condensation at 50°C . UV irradiance may be monitored and maintained by the manual method or by the feed-back-loop method as described in SAE J2020.

8.3 The use of these cycles does not imply, expressly or otherwise, an acceler-

ated weathering test, nor is this method restricted to the use of these cycles. The degree of correlation to any actual outdoor weathering exposure must be determined by quantitative analysis.

9. Standards of Comparison

9.1 Standards for comparisons can be made of any suitable textile material where a history of strength degradation or color change rates are known depending upon individual test needs. They must be exposed simultaneously with the test specimen to be investigated. The intent of these standards is to demonstrate uniformity between separate machine and test runs. When test data of the exposed standards differ by more than 10% from the known data, the test machine operating conditions must be thoroughly reviewed and any malfunctions or defective parts corrected. The test is then repeated. If the data still differ by more than 10% from the known data and there is no evidence of machine malfunction, then the test standard should be questioned and re-evaluated. Test data obtained with questionable standards must be treated with caution and resolution provided with quantitative analysis.

10. Procedure

10.1 Maintain and calibrate the apparatus in accordance with the manufacturer's recommendations.

10.2 Before beginning the exposure test, bring all specimens, control and test, to moisture equilibrium in the atmosphere for testing textiles in accordance with ASTM D 1776, Standard Practice for Conditioning and Testing Textiles. Equilibrium is considered to have been reached when the increase in mass of the specimen in successive weightings made at intervals of not less than 2 h does not exceed 0.1% of the mass of the specimen. Perform any necessary tests or evaluations necessary to establish a base line for comparing the unexposed specimens to the exposed specimens.

10.3 Specimen Mounting. Mount the specimens in the frames which are supplied with the cabinet with the test surfaces facing the lamp. When the test specimens do not completely fill the racks, the empty spaces must be filled with blank panels to maintain the test conditions within the chamber.

10.3.1 To provide rigidity, flexible specimens may be attached to a backing panel made of aluminum or other noncorrosive heat conductive material.

10.3.2 Holes in specimens and any openings larger than 1 mm around irregularly shaped specimens shall be sealed to prevent loss of water vapor. Porous specimens shall be backed with a vapor barrier such as aluminum or plastic.

10.3.3 Fabrics. Flexible fabric specimens are mounted by simply wrapping them around an aluminum blank and clamping them into place with the spring ring clip. The specimens should present a smooth face to the inside of the chamber (see Fig. 1).

10.3.4 Yarns. Yarns should be wound on frames to a length of 150 mm minimum. Only that portion of the yarns directly facing the radiant energy is tested for breaking (tensile) strength. Single strand or multiple strand testing may be performed. When multiple strand testing is to be performed, the yarns are wound on the frame closely packed to 25.4 mm width. The control specimens must contain the same number of strands as the specimen subjected to exposure. After the exposure has been completed and before the yarns are unwound for testing, those yarns facing the light source are bound together by the use of 20 mm masking or other suitable type tape to maintain the closely packed arrangements on the exposure frame.

10.3.5 In the case of woven, knitted and nonwoven fabrics ensure that the side directly exposed to the radiant source is the one normally used as the face.

10.4 Program the device to achieve the required test conditions and operate the apparatus continuously within the limits specified above. Use test conditions specified in 8.2 or agreed to by mutual consent or as required by a product quality specification.

10.5 Operate continuously, repeating the cycle, except for servicing the instrument and inspection of specimens. Inspect specimens daily during the middle of a condensation cycle to make sure all specimens are uniformly wetted.

10.6 To minimize any effects from temperature or UV light variation, it is recommended that specimens be repositioned as shown in Fig. 2. Rotate samples horizontally once each week by (1) moving the two extreme right hand specimen holders to the far left of the exposure area

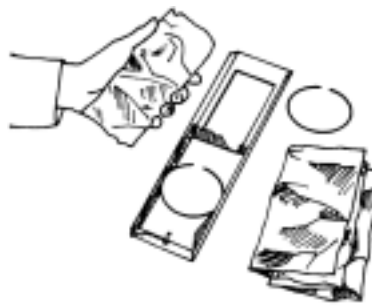

Fig. 1—Typical mounting for flexible fabric specimens.

and (2) sliding the remaining specimen holders to the right.

11. Periods of Exposure

11.1 Use one of the following methods to determine the duration of the exposure:

11.1.1 A specified number of total hours.

11.1.2 The number of total hours of exposure required to produce an amount of change in either the test specimen or an agreed upon standard sample.

12. Conditioning

12.1 If the test and control samples are wet upon removal from the tester, dry them at ambient laboratory conditions or at a temperature not exceeding 71°C.

12.2 Condition the test and control samples in the controlled atmosphere for testing textiles. Bring all specimens to moisture equilibrium. Equilibrium is considered to have been reached when the increase in mass of the specimen in successive weighings made at intervals of not less than 2 h does not exceed 0.1% of the mass of the specimen. In general practice, the industry approaches equilibrium from the "As Received" side.

12.3 For each test to be made on the material and control, exposed and unexposed, prepare test specimens by marking

and raveling or cutting the central portion of each exposed specimen to the dimensions specified in the respective test procedure. Marking and raveling or cutting of the test specimens is preferred after the exposure but may be done before exposure. Control specimens not exposed are similarly prepared and are wet-out and allowed to dry without tension before testing.

13. Evaluation of Results

13.1 Changes in exposed test specimens shall be evaluated or rated by applicable AATCC, ASTM or ISO test methods.

13.2 Physical Properties

13.2.1 Ball Bursting Strength of Fabrics. Determine the ball bursting strength of fabrics as directed in ASTM Test Method D 3787, Test Method for Bursting Strength of Knitted Goods: Constant Rate of Traverse (CRT) Ball Burst Test.

13.2.2 Grab Tensile Test. Determine the grab tensile strength as directed in ASTM D 5034, Test Method for Breaking Strength and elongation of Textile Fabrics (Grab Test).

13.3 Color Change.

13.3.1 Evaluate the color change as directed in AATCC Method 16, Colorfastness to Light.

14. Report

14.1 Report the following information on exposure conditions:

14.1.1 Manufacturer and model of fluorescent UV/condensation apparatus.

14.1.2 The manufacturer's designation for the fluorescent UV lamp.

14.1.3 Exposure cycle, for example, 4 h UV/60°C, 4 h CON/50°C.

14.1.4 Total exposure time.

14.1.5 Total UV light exposure time.

14.1.6 Any deviation from the exposure test method

14.2 Report the following information on the test specimen:

14.2.1 The type of fiber(s) of which the material is composed, which side of the fabric was exposed (in the event that the fibers differ on the face and back of the fabric), the fabric weight in g/m² and the nature of the fabric finish, if known.

14.3 Report the following information on the evaluation:

14.3.1 The evaluation method, rating and relative data for each property evaluated.

14.3.2 The standard used for comparative evaluation, if any.

14.3.3 Data. Average the data for the various replicates, or handle statistically as appropriate, and record a significant value of breaking or bursting strength retention and/or color change after exposure in relation to original strength or color as applicable. Report must contain as a minimum:

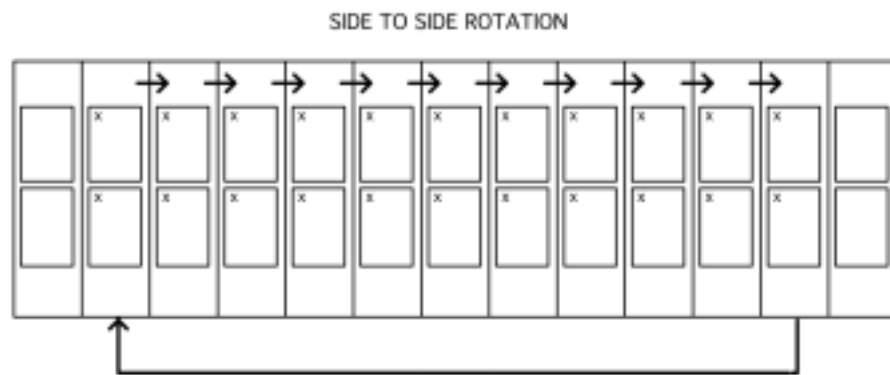

Fig. 2—Specimen rotation.

- (a) Arithmetic mean or average,
- (b) The number of tests,
- (c) Standard deviation or coefficient of variation.

Statement of a mean without the number of tests and precision is essentially useless.

15. Precision and Bias

15.1 Precision.

15.1.1 *Laboratory Study.* In early 1999, a small study was done in a single laboratory to get an estimate of intra-laboratory precision. One fabric (greige, #400 style cotton print cloth) was exposed under conditions of this test method and values determined for ΔE^*_{ab} , grab tensile after exposure, and ball burst after exposure.

15.1.2 *Intra-Laboratory Precision.* Components of variance and *within-laboratory* precision shown as critical differences are given for each of these properties, respectively, in Tables I, II and III.

15.1.3 For each of the properties noted,

Table I— ΔE^*_{ab}		
Mean	Sample Variance	Standard Deviation
9.7	0.2	0.4
95% Level		
Values in Average	Standard Error	Critical Difference
1	0.4	1.2
2	0.3	0.8
3	0.2	0.7
4	0.2	0.6
5	0.2	0.5
6	0.2	0.5
7	0.2	0.5
8	0.2	0.4
9	0.1	0.4
10	0.1	0.4

Table II—Grab Tensile after Exposure

Exposed Grab		
Mean	Sample Variance	Standard Deviation
59	29	5.4
95% Level		
Values in Average	Standard Error	Critical Difference
1	5.4	15.1
2	3.8	10.4
3	3.1	8.7
4	2.7	7.5
5	2.4	6.7
10	1.7	4.8
Control Grab		
Mean	Sample Variance	Standard Deviation
75.2	6.6	2.6

Table III—Ball Burst after Exposure

Exposed Ball Burst		
Mean	Sample Variance	Standard Deviation
83	81	9
95% Level		
Values in Average	Standard Error	Critical Difference
1	9.0	25.2
2	6.4	17.8
3	5.2	14.6
4	4.5	12.6
5	4.0	11.3
10	2.8	8.0
Control Ball Burst		
Mean	Sample Variance	Standard Deviation
87	55	7.4

when differences are due only to chance causes, the differences between test results should not exceed the value shown in 95 of the 100 comparisons.

15.1.4 Analysis of variance or *t*-tests may be used to compare averages. See any standard statistical text for more information.

15.2 Bias.

15.2.1 There is no referee test method for determining definitive values to establish bias in this test method. The test method has no known bias.

16. Referenced Documents

16.1 The following AATCC documents are referenced:

16.1.1 Evaluation Procedure 6, Instrumental Color Measurement (see 17.3).

16.1.2 Test Method 16, Colorfastness to Light (see 17.3).

16.2 The following ASTM documents are referenced:

16.2.1 ASTM D 123, Standard Terminology Relating to Textiles (see 17.4)

16.2.2 ASTM D 3787, Test Method for Bursting Strength of Knitted Goods: Constant Rate of Traverse (CRT) Ball Burst Test (see 17.4).

16.2.3 ASTM D 5034, Test Method for Breaking Strength and Elongation of Textile Fabrics (Grab Test) (see 17.4)

16.3 The following SAE document is referenced:

16.3.1 SAE J2020, Standard Test Method for Accelerated Exposure of Automotive Exterior Materials Using a Fluorescent UV and Condensation Apparatus (see 17.5).

17. Notes

17.1 Apparatus and lamps which conform to this test method are available from the following companies: Q-Panel Lab Products, 26200 First St., Cleveland OH 44145; tel: 440/835-8700; fax: 440/835-8738; SDL Atlas L.L.C., 1813A Associate Lane, Charlotte NC 28217; tel: 704/329-0911; fax: 704/329-0914; e-mail: info@sdlatlas.com; and Suga Test Instruments, 5-4-14 Shinjuku-Ku, Tokyo 160, Japan; tel: 81 (3) 3354 5248; fax: 81 (3) 3354-5275.

17.2 The exposure chamber shall be a Fluorescent UV/Condensation Apparatus constructed of corrosion-resistant materials enclosing eight fluorescent UV lamps, a heated water pan, water spray system (optional), test specimen racks and provisions for controlling and indicating operating times and temperatures

17.3 Available from AATCC, P.O. Box 12215, Research Triangle Park NC 27709; tel: 919/549-8141; fax: 919/549-8933; e-mail: orders@aatcc.org.

17.4 Available from ASTM 100 Barr Harbor Dr., West Conshohocken PA 19428; tel: 610/832-9500; fax: 610/832-9555.

17.5 Available from SAE International, 400 Commonwealth Dr., Warrendale PA 15098-0001; tel: 412/776-4841.

17.6 The limits of the spectral range of ultraviolet radiation are not well defined and may vary according to the user. Committee

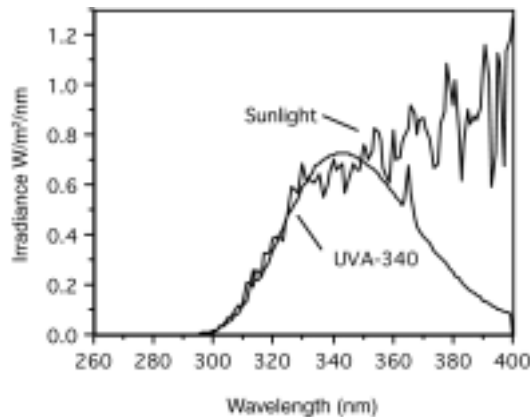

Fig. 3—Representative spectral power distribution, UVA-340 fluorescent lamps

E-2.1.2 of CIE distinguishes in the spectral range between 400 and 100 nm:

UV-A	315-400 nm
UV-B	280-315 nm
UV-C	100-280 nm

Unless otherwise specified, the lamps shall be UV-A Type Fluorescent UV lamps with a peak emission at 343 nm and a spectral energy distribution (SED) as shown in Fig. 3.

17.7 Condensation Mechanism. Water vapor shall be generated by heating a water pan extending under the entire specimen mounting area and containing a minimum water depth of 25 mm. Specimen racks and the test specimens themselves shall constitute the sidewalls of the chamber. The backside of the specimens shall be exposed to cooling effects of ambient room air. The resulting heat transfer causes water to condense on the test surface.

17.7.1 The specimens are arranged so that condensate runs off the test surface by gravity and is replaced by fresh condensate in a continuous process. Vents along the bottom of the test chamber shall be provided to permit an exchange of ambient air and water vapor to prevent oxygen depletion of the condensate.

17.7.2 Water supply with an automatic control to regulate the level in the water pan shall be provided. Distilled, deionized or potable tap water are equally acceptable for purposes of the test, because the condensation process itself distills water onto the test surface.

17.8 Specimen temperature shall be measured by a Black Panel Thermometer with a

remote sensor attached to a black aluminum panel. The thermometer shall be precise to $\pm 1^\circ\text{C}$ through a range from 30-80°C and shall be positioned in the center of the exposure area so that the sensor is subject to the same conditions as the specimens.

17.9 During UV exposure, the selected equilibrium temperature shall be maintained within $\pm 3^\circ\text{C}$ by supplying heated air to the test chamber. During condensation exposure, the selected equilibrium temperature shall be maintained within $\pm 3^\circ\text{C}$ by heating the water in the water pan.

17.10 The test specimens shall be mounted in stationary racks with the plane of the test surface facing the lamps and exposed within an area 210 mm in height by 900 mm wide on each side of the apparatus located as shown in Fig. 4. It is possible to mount specimens above, below, and beside the 210 × 900 mm area, but specimens so mounted will be exposed to lower UV intensities.

17.11 Apparatus shall be located in an area maintained at a temperature between 20°C and 30°C. The room temperature shall be measured by thermometers mounted on interior walls or columns approximately 1500 mm above the floor level and at least 300 mm from any heated apparatus. Three or more thermometers located at various points will show any temperature variation in the area.

17.11.1 It is recommended that the apparatus be located at least 300 mm from walls or other apparatus. Nearby heat sources, such as ovens or heated test apparatus, should be avoided or shielded, because such heat sources can reduce the cooling required for condensation.

17.11.2 The room where the apparatus is located shall be ventilated to remove the heat and moisture produced and to maintain the temperatures specified above. Two to four air changes per hour will normally provide sufficient ventilation.

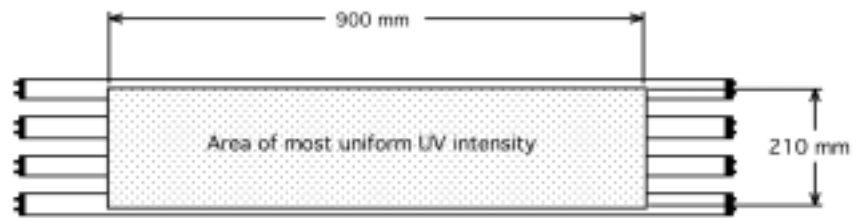

Fig. 4—Area of most uniform light intensity.

Dimensional Changes of Fabrics: Accelerated

Developed in 2000 by AATCC Committee RA42; reaffirmed 2001, 2002; revised 2004.

1. Purpose and Scope

1.1 This test method is an accelerated procedure for determination of the dimensional change of fabrics. The procedure uses an apparatus with programmable settings that simulate multiple home or commercial laundering actions as well as wet processing operations.

1.2 This method does not replace dimensional change test methods currently in use.

2. Principle

2.1 Dimensional changes are determined by comparing the distances between length and width direction benchmarks before and after a programmed test cycle.

3. Terminology

3.1 **dimensional change**, n.—a generic term for changes in length or width of a fabric specimen subjected to specified conditions. The change is usually expressed as a percentage of the initial dimension of a specimen.

3.2 **growth**, n.—of textile materials, a dimensional change resulting in an increase of length or width of a specimen.

3.3 **laundering**, n.—of textile materials, a process intended to remove soils and/or stains by treatment (washing) with an aqueous detergent solution and normally including subsequent rinsing, extracting and drying.

3.3 **shrinkage**, n.—of textile materials, dimensional change resulting in a decrease in the length or width of a specimen.

4. Safety Precautions

NOTE: These safety precautions are for information purposes only. The precautions are ancillary to the testing procedures and are not intended to be all-inclusive. It is the user's responsibility to use safe and proper techniques in handling materials in this test method. Manufacturers MUST be consulted for specific details such as material safety data sheets and other manufacturer's recommendations. All OSHA standards and rules must also be consulted and followed.

4.1 Good laboratory practices should be followed. Wear safety glasses in all laboratory areas.

4.2 Manufacturer's safety recommendations should be followed when operating accelerated testing equipment.

5. Uses and Limitations

5.1 Although data have been generated comparing the dimensional change of some textile materials after home laundering and this accelerated apparatus, the user will find it necessary to determine the correlation between the results from a selected program for this apparatus and the dimensional change results from other chosen test methods or wet processes.

5.2 Dimensional changes exhibited by articles produced from textile fabrics are primarily (but not entirely) dependent on dimensional changes exhibited by the fabric.

5.3 While the term "laundering" includes the use of an aqueous detergent solution, this accelerated method does not use detergents.

6. Apparatus and Materials

6.1 Accelerated laundering apparatus (see 14.1).

6.2 Indelible ink marking pen. Select marking pens with the smallest tip (see 14.2).

6.3 Tape or ruler marked in millimeters.

6.4 For 250 mm bench marks, a tape or ruled template marked with, or from which, percent dimensional change to 0.5% or smaller increment can be directly read (see 14.2).

6.5 Digital Imaging System (see 14.3).

7. Sampling

7.1 Take a sufficient number of samples from a lot to provide an adequate number of data points to generate satisfactory precision.

7.2 It is recommended that a minimum of four specimens with different length and widthwise yarns in each specimen be taken from each sample.

8. Specimens

8.1 Cut specimens parallel to the lengthwise fabric direction as shown in Fig. 1a. Diagonal alignment of specimens may be selected to minimize the need for over-edging specimens and to obtain larger bench mark dimensions (see Fig. 1b).

8.2 The size of specimens may depend upon the model of the apparatus and the type, number and configuration of its basket chambers.

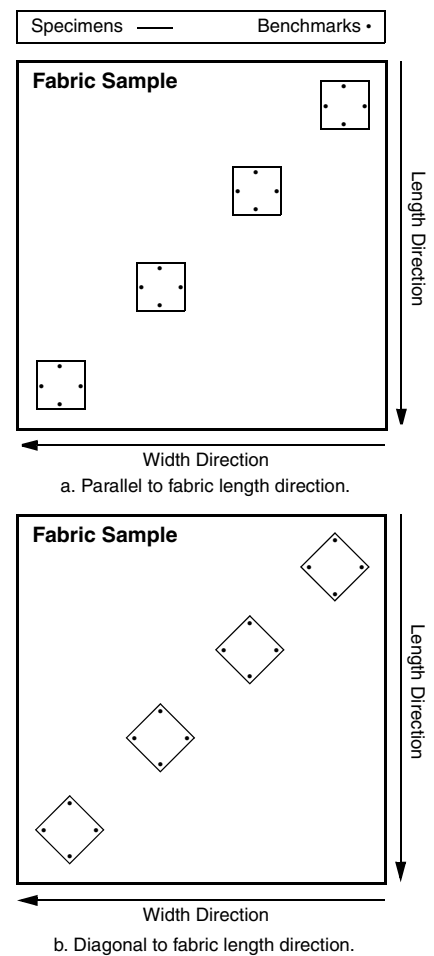

Fig. 1—Specimen and bench mark placement.

8.2.1 Specimens, 190 × 190 mm, aligned with the fabric length and width directions and marked with 125 mm bench mark distances are recommended by the instrument manufacturer. Alternatively, 230 × 230 mm specimens can be cut diagonally to accommodate 250 mm bench mark distances that are aligned with the actual length and width directions of the fabric (see Fig. 1b).

8.3 The use of standard textile conditioning prior to or after a test cycle program completion is not required.

8.4 To improve the accuracy and precision of dimensional change calculations based on the bench mark distances applied to the specimens as in 8.2.1, measure and record the distance between each pair of bench marks with suitable tape or ruler to the nearest millimeter before starting the test. This is measurement A. If using a template or ruler from which direct percent dimensional change can be

read, verify that the original bench mark distances are exact.

9. Test Procedure

9.1 Using the program in Table I, determine whether the results obtained from this program correlate with testing the same fabric by selected end-use test procedure. If the program in Table I does not generate satisfactory correlation with dimensional change results from the selected end-use test procedure, alter program elements such as number of rinses and drying time.

9.2 Follow the equipment manufacturer's recommendations for the number of specimens to be tested in each basket chamber.

9.3 Start the machine and allow the program to run through to completion.

9.4 Ensure that specimens are completely dry at the end of the drying program. If specimens hang up in the chamber during drying, they will not be completely dry. If this occurs, discard the crumpled tested specimens. Prepare additional specimens and repeat the test program.

9.5 After completion of the selected program, remove specimens and place them on a flat surface for a minimum of 5 min prior to measurement.

10. Measurement

10.1 Measure and record bench mark distances for each specimen in each fabric direction to the nearest increment of the ruler or device used. This is measurement B (see 11.2).

10.2 Measure and record, to the nearest incremental unit in each fabric direction, the percent dimensional change from the ruler or device used.

11. Calculation

11.1 If measurements were taken in units of percent dimensional change, average the measurements in each direction separately to the nearest 0.1%.

11.2 If bench mark measurements were

taken, calculate the individual and average dimensional change results in each direction separately to the nearest 0.1% as follows:

$$\%DC = 100[(B-A)/A]$$

where:

- DC = Dimensional change
- A = Original bench mark distance
- B = Bench mark distance after laundering test cycle

11.3 A final measurement smaller than the original measurement indicates negative dimensional change which is shrinkage (minus sign). A final measurement larger than the original measurement indicates positive dimensional change which is growth (plus sign).

12. Report

12.1 For each sample tested, report:

- (a) Individual and average percent length and width dimensional change, separately, to the nearest 0.1% with the appropriate dimensional sign (shrinkage negative/growth positive);
- (b) Program used; and
- (c) Specimen size, alignment (see Figs. 1a or 1b) and number of specimens in each basket chamber.

13. Precision and Bias

13.1 Precision.

13.1.1 In a preliminary multiple lab study, five fabrics were tested in ten labs. One operator tested samples on two different days in each lab. Study samples were: 80 cotton/20 polyester knit fleece, 100% cotton twill, 50 cotton/50 polyester knit jersey, 100% cotton oxford and 100% cotton knit pique. Lab results were reported as the average of ten specimens for each fabric. Lab results were obtained on two different days for each fabric. While the total study included test results from five accelerated cycles, the data used in this precision analysis were the reported dimensional change results obtained from only the first accelerated test cycle.

13.1.2 The reported precision was ob-

tained from a component of variance analysis. Two different standard deviations were calculated: the standard deviation of within lab variation (Se) and the standard deviation of lab-to-lab and within lab variations combined (Sc).

13.1.3 The preliminary precision was obtained from a component of variance analysis. Tables II and III show the interaction of the analysis and standard deviations: the standard deviation of within-lab variation (Se) and the standard deviation of lab-to-lab and within-lab variations combined (Sc) for each fabric direction. Average dimensional change percent and component of variance analysis for each sample is shown in Appendix A.

13.1.4 Tables IV and V show single fabric and multiple fabric *within-* and *between-laboratory* standard error (SE) and critical difference (CD) values.

13.2 Bias.

13.2.1 Dimensional change (%) can be defined only in terms of a test method or procedure. This test method has no known bias.

14. Notes

14.1 Quickwash Plus™ System may be obtained from SDL Atlas L.L.C., 1813A Associate Lane, Charlotte NC 28217; tel: 704/329-0911; fax: 704/329-0914; e-mail: info@sdlatlas.com.

14.2 Marking pens are available from Mark-Tex Corp., P.O. Box 6, Englewood NJ 97631; and AATCC, P.O. Box 12215, Research Triangle Park NC 27709, tel: 919-549-8141; fax: 919-549-8933; e-mail: orders@aatcc.org. Measuring ruler available from AATCC.

14.3 A digital imaging system may be used as a measuring device in place of the prescribed manual measurement devices if it is established that its accuracy is equivalent to the manual devices.

Table I—Accelerated Machine Program Settings*

Program Operation	Number of Cycles	Time per Cycle, s	Temperature, °C
Wash**	1		60°C
Agitation time		165 s	
Rinse/dry	3		60°C
Agitation time		45 s	
Spin time		35 s	
Dry time		240 s	
Air pressure, 3.8 bars			
Water level, 3 L			

*According to the machine manufacturer, prior tests have established that this program generates 95% of the total dimensional change in 95% of fabrics tested.

**The term "wash" implies the use of detergent, but correlation tests by users have shown that the addition of detergent is not necessary in this accelerated test. Due to the nature of the action of the accelerated test procedure, even a slight amount of detergent foams and impedes the test.

Table II—Component of Variance Analysis

COV	Variance Length	Variance Width
Lab V(L)	0.26	0.11
Fab/Lab V(FL)	0.32	0.23
Days W/I Fabric V(D(F))	0.36	0.00
Samples W/I Days and Fabric V(S(DF))	0.00	0.08
Error V	0.19	0.08

Table III—Within Lab and Combined Lab-to-Lab and Within Lab Percent Dimensional Change at the 95% Probability Level = 2Se and 2Sc

FABRIC	LENGTH		WIDTH	
	Se	Sc	Se	Sc
Knit Fleece	0.49	0.69	0.38	0.70
Twill	0.34	1.01	0.20	0.35
Knit Jersey	0.34	0.95	0.37	0.52
Oxford	0.53	0.88	0.55	1.06
Knit Pique	0.29	0.66	0.17	0.48

Table IV—Length Precision

Det/Avg	Single Fabric Within Lab		Comparison Between Labs		Multiple Fabric Within Lab		Comparisons Between Labs	
	(Single Op)				(Single Op)			
N	SE	CD	SE	CD	SE	CD	SE	CD
1	0.42	1.17	0.66	1.84	0.71	1.96	0.87	2.41
2	0.30	0.83	0.59	1.64	0.64	1.77	0.82	2.27
3	0.24	0.68	0.57	1.57	0.62	1.71	0.80	2.22
4	0.21	0.59	0.55	1.53	0.60	1.67	0.79	2.19
5	0.19	0.52	0.54	1.51	0.60	1.65	0.79	2.18
7	0.16	0.44	0.53	1.48	0.59	1.63	0.78	2.16

Table V—Width Precision

Det/Avg	Single Fabric Within Lab		Comparison Between Labs		Multiple Fabric Within Lab		Comparisons Between Labs	
	(Single Op)				(Single Op)			
N	SE	CD	SE	CD	SE	CD	SE	CD
1	0.29	0.80	0.44	1.23	0.56	1.54	0.65	1.80
2	0.21	0.57	0.39	1.09	0.52	1.42	0.61	1.71
3	0.17	0.46	0.38	1.04	0.50	1.39	0.61	1.68
4	0.15	0.40	0.37	1.02	0.50	1.38	0.60	1.67
5	0.13	0.40	0.36	1.00	0.49	1.36	0.60	1.65
7	0.11	0.30	0.35	0.98	0.49	1.35	0.59	1.64

Appendix A. Component of Variance Analysis for Individual Fabrics*

Fabric	Direction	DC% AVG	Lab V(L)	Day V(D)	Lab/Day V(L/D)	Fabrics V(F W/I D)	Error V
Fleece 80c/20p	length	11.34	0.24	1.19	0.12	0.00	0.49
	width	5.40	0.16	0.15	0.00	0.19	0.14
Twill 100c	length	3.84	0.91	0.17	0.26	0.28	0.34
	width	1.21	0.08	0.01	0.01	0.00	0.04
Jersey 50c/50p	length	6.06	0.61	0.10	0.36	0.90	0.34
	width	1.11	0.13	0.00	0.04	0.00	0.14
Oxford 100c	length	2.87	0.48	0.05	0.14	0.00	0.54
	width	4.72	0.83	0.04	0.00	0.00	0.30
Pique 100c	length	9.05	0.35	0.29	0.11	0.02	0.29
	width	6.98	0.20	0.01	0.08	0.00	0.03

*DC = Dimensional change
V = Variance
L = Lab
D = Day
F = Fabric
W/I = Within

Colorfastness to Sodium Hypochlorite Bleach in Home Laundering

Developed in 2000 by AATCC Committee RA60; editorially revised and reaffirmed 2001; reaffirmed 2002; revised 2003; editorially revised 2004.

1. Purpose and Scope

1.1 This test method is used to determine the colorfastness to sodium hypochlorite bleach, commonly called "chlorine bleach," in home laundering of textiles which are expected to withstand frequent laundering.

1.2 Results of this test method may be used in combination with other testing for establishing care instructions (see 5.1, 9.6 and 12.8).

1.3 If a chlorine bleach contains ingredients other than the sodium hypochlorite, it is the total effect of these chemicals on the color change that is being evaluated.

1.4 This test method is designed for home laundering devices. An accelerated colorfastness test simulating multiple home laundering (including those with sodium hypochlorite) is described in Test Method 61, Colorfastness to Laundering, Home and Commercial: Accelerated. There is no known correlation between those sections of Method 61 and this method.

2. Principle

2.1 Specimens are laundered under appropriate conditions of temperature, detergent solution, chlorine bleach solution and abrasive action for five home laundering cycles. The laundered specimens are evaluated for color change.

3. Terminology

3.1 **bleach**, n.—*in home laundering*, a product that will clean, whiten, brighten and aid in the removal of soils and stains from textile materials by oxidation that is inclusive of chlorine and non-chlorine products.

3.2 **care instructions**, n.—*in textiles*, a series of directions describing which care practices should refurbish a product without adverse effects and warning of those care practices expected to have a harmful effect (see 12.1).

3.3 **colorfastness**, n.—the resistance of a material to change in any of its color characteristics, to transfer of its colorant(s) to adjacent materials or both, as a result of the exposure of the material to any environment that might be encountered during the processing, testing, storage or use of the materials.

3.4 **laundering**, n.—*of textile materials*, a process intended to remove soil and/or stains by treatment (washing) with an aqueous detergent solution and normally including subsequent rinsing, extracting and drying.

3.5 **sodium hypochlorite bleach**, n.—4-6% solution of sodium hypochlorite (NaOCl), pH 9.8-12.8, commonly called "chlorine bleach."

4. Safety Precautions

NOTE: These safety precautions are for information purposes only. The precautions are ancillary to the testing procedures and are not intended to be all inclusive. It is the user's responsibility to use safe and proper techniques in handling materials in this test method. Manufacturers MUST be consulted for specific details such as material safety data sheets and other manufacturer's recommendations. All OSHA standards and rules must also be consulted and followed.

4.1 Good laboratory practices should be followed. Wear safety glasses in all laboratory areas.

4.2 Manufacturer's safety recommendations should be followed when operating laboratory testing equipment.

4.3 The 1993 AATCC Standard Reference Detergent may cause irritation. Care should be taken to prevent exposure to skin and eyes.

4.4 All chemicals should be handled with care.

4.5 In preparing, dispensing and handling bleach and detergent, use chemical goggles or face shield, impervious gloves and an impervious apron.

4.6 If concentrated sulfuric acid is diluted to prepare the 10% acid (see 14.8.1 and 14.8.3), use chemical goggles or face shield, impervious gloves and an impervious apron. Concentrated acids should be handled only in an adequately ventilated hood. CAUTION: Always add acid to water.

4.7 An eyewash/safety shower should be located nearby and an organic vapor respirator should be available for emergency use.

4.8 Exposure to chemicals used in this procedure must be controlled at or below levels set by governmental authorities (e.g., Occupational Safety and Health Administration's [OSHA] permissible exposure limits [PEL] as found in 29 CFR 1910.1000 amended January 1, 1989). In addition, the American Congress of Governmental Industrial Hygienist

(ACGIH) Threshold Limit Values (TLVs) comprised of time weighted averages (TLV-TWA), short term exposure limits (TLV-STEL) and ceiling limits (TLV-C) are recommended as a general guide for air contaminant exposure which should be met (see 14.1).

5. Uses and Limitations

5.1 Specimens may be tested using these procedures, but without sodium hypochlorite bleach, to determine the effect of laundering with water and/or water and detergent alone (see 9.6 and 12.8). To test for colorfastness to non-chlorine bleach, see AATCC Method 172, Colorfastness to Non-Chlorine Bleach in Home Laundering (see 14.2).

6. Apparatus and Materials

6.1 Automatic washing machine (see 14.3).

6.2 Automatic tumble dryer (see 14.4).

6.3 Conditioning/drying racks with pull-out screens or perforated shelves (see 14.5).

6.4 Ballast of 920 × 920 mm hemmed pieces of cloth (see 14.6). Choose one of the following.

6.4.1 Ballast type 1, bleached cotton sheeting.

6.4.2 Wash load ballast type 3, 50/50 polyester/cotton plain weave.

6.5 1993 AATCC Standard Reference Detergent WOB (see 14.7).

6.6 Drip and line drying facilities.

6.7 Balance with at least 5 kg minimum capacity and sensitivity to ± 0.1 g.

6.8 Lab timer.

6.9 AATCC Gray Scale for Color Change (see 14.7) or suitable colorimeter or spectrophotometer for color change.

7. Reagents

7.1 Sodium hypochlorite (NaOCl), 4-6%.

7.2 Distilled water.

7.3 Sulfuric acid, H₂SO₄, (10% solution).

7.4 Potassium iodide, KI, (10% solution).

7.5 Sodium thiosulfate, Na₂S₂O₃, (0.1N).

8. Test Specimens

8.1 Use one specimen weighing 110.0 ± 10.0 g from a sample. If a garment or textile item (towel, bed sheet, etc.) is to be used as a specimen, weigh the entire item to 0.1 g. If the garment weight exceeds the specified load weight of 1.8 kg,

the total weight is to be included in the report. See 9.2.3 for exact weight specifications on load.

9. Procedure

9.1 Tables I, II and III summarize washing and drying conditions which may be used in the test.

9.2 Washing.

9.2.1 Fill the washer with the specified water volume at the selected water temperature using the normal cycle setting. Measure and record the water hardness in any test.

9.2.2 Add 66 ± 1 g of 1993 AATCC Standard Reference Detergent WOB (see 6.5). Add 240 ± 5 mL (1 cup) of sodium hypochlorite bleach or the amount recommended by the manufacturer for a full load of laundry. Run the washer for 2 min to ensure proper mixing of liquor.

9.2.3 Add enough ballast to the specimen to make a 1.8 ± 0.1 kg load. Set the washer on the cycle selected for washing and set the wash timer (see Tables I and II). Start the agitation and independently time the wash for reproducible results. When the desired wash time is complete, stop washer and advance the dial to the end of the wash cycle. Restart washer to rinse, drain and spin the load.

9.2.4 For the specimen to be dried by procedures A, B or D, allow washing to proceed through the rinse and final spin cycle. Remove test specimens immediately after the final spin cycle, separate any tangled pieces, taking care to minimize distortion, and dry by procedures A, B or D (see Tables I and III).

9.2.5 For the specimen to be dried by procedure C, Drip Dry, stop the washer at the end of the final rinse cycle just before the water begins to drain. Remove the specimens soaking wet.

9.3 Drying.

9.3.1 (A) Tumble Dry. Place the washed load (test specimens and ballast) in the tumble dryer, set on the cycle which generates the correct exhaust temperatures as specified in Table III. For fabrics that are heat sensitive, lower temperatures consistent with producer's recommendation are required and must be reported. Operate the dryer until the total load is dry. Remove the load immediately after the machine stops.

9.3.2 (B) Line Dry. Hang each specimen by two corners with the fabric length in the vertical direction. Allow the test specimens to hang in still air at room temperature until dry.

9.3.3 (C) Drip Dry. Hang each dripping wet specimen by two corners, with the

fabric length in the vertical direction. Allow specimens to hang in still air at room temperature until dry.

9.3.4 (D) Screen Dry. Spread each specimen on a horizontal screen or perforated surface, removing wrinkles but not distorting or stretching and allow to dry in still air at room temperature.

9.4 Repeat 9.2 and 9.3 for a total of five launderings or to an end point of color change (see 14.2).

9.5 On completion of the fifth laundry cycle, (or after each cycle where end point criteria are to be met), condition the specimens for at least 4 h by laying each specimen separately on the screen or perforated shelf of a conditioning rack at an atmosphere of $21 \pm 1^\circ\text{C}$ and 65 ± 2 RH before evaluating color change.

9.6 If this test method is to be used to develop care instructions, specimens may also have to undergo further testing. Non-chlorine bleach sensitivity may need to be tested using AATCC Method 172. To separate the effects of components such as hardness, pH or bleach content (see 5.1, 12.8 and ASTM Method D 3938), this method with detergent only and/or this method using water only may be used.

10. Evaluation

10.1 Visual evaluation.

10.1.1 Using an unwashed specimen from the sample as a control, rate the color change of the test specimen in at least three places on the specimen or three times in one place using the Gray Scale for Color Change (see AATCC Evaluation Procedure 1).

Grade 5—negligible or no change as shown in Gray Scale Step 5.

Grade 4.5—a change in color equivalent to Gray Scale Step 4-5.

Grade 4—a change in color equivalent to Gray Scale Step 4.

Grade 3.5—a change in color equivalent to Gray Scale Step 3-4.

Grade 3—a change in color equivalent to Gray Scale Step 3.

Grade 2.5—a change in color equivalent to Gray Scale Step 2-3.

Grade 2—a change in color equivalent to Gray Scale Step 2.

Grade 1.5—a change in color equivalent to Gray Scale Step 1-2.

Grade 1—a change in color equivalent to Gray Scale Step 1.

10.1.2 Ratings may be made compared to an unexposed control cut from the test sample or compared to a laundered control specimen of known fastness.

10.2 Instrumental evaluation.

10.2.1 Instrumental measurements comparing unexposed and exposed, (washed), specimen or garments may be used (see AATCC Evaluation Procedures 6 and 7 and AATCC Method 173).

Table I—Washing and Drying Conditions

Machine Cycle	Wash Temperatures	Drying Procedures
(1) Normal or Cotton/Sturdy	(II) $27 \pm 3^\circ\text{C}$ ($80 \pm 5^\circ\text{F}$)	(A) Tumble: i. Cotton/Sturdy
(2) Delicate	(III) $41 \pm 3^\circ\text{C}$ ($105 \pm 5^\circ\text{F}$)	ii. Delicate
(3) Permanent Press	(IV) $49 \pm 3^\circ\text{C}$ ($120 \pm 5^\circ\text{F}$)	iii. Permanent Press
	(V) $60 \pm 3^\circ\text{C}$ ($140 \pm 5^\circ\text{F}$)	(B) Line
		(C) Drip
		(D) Screen

Table II—Typical Washing Machine Operating Parameters¹

	Normal	Permanent Press	Delicate
(A) Water Level (Without Load)	64.3 ± 3.8 L	64.3 ± 3.8 L	64.3 ± 3.8 L
(B) Agitator Rate	179 ± 2 spm ²	179 ± 2 spm	119 ± 2 spm
(C) Washing Time	12 min	10 min	8 min
(D) Spin Speed	645 ± 15 rpm ³	430 ± 15 rpm	430 ± 15 rpm
(E) Final Spin Cycle	6 min	4 min	4 min

¹ Per machine specifications.

² spm = strokes per minute.

³ rpm = revolutions per minute.

Table III—Dryer Conditions

	Normal or Cotton/Sturdy	Permanent Press	Delicate
Exhaust Temperature	High $66 \pm 5^\circ\text{C}$ ($150 \pm 10^\circ\text{F}$)	High $66 \pm 5^\circ\text{C}$ ($150 \pm 10^\circ\text{F}$)	Low < 60°C (< 140°F)
Cool Down Time	10 min	10 min	10 min

11. Interpretation of Results

11.1 This test is a satisfactory end use test for demonstrating the effect of the 1993 AATCC Standard Reference Detergent WOB and chlorine bleach on textile materials in home laundering. The color change results will establish a level of performance that can be used to prepare care instructions (see ASTM D 3938; 14.9).

11.2 If a significant color change is observed, an untreated duplicate sample should be retested using this method with water only and/or by following AATCC Method 172 (see 9.6).

12. Report

12.1 Report the numerical average color change grade for each specimen tested.

12.2 Report washing conditions (Arabic and Roman Numerals) and drying conditions (capital letter from Table I; [i.e., (1) IIIA (iii)] means NORMAL cycle, wash water temperature of $41 \pm 3^\circ\text{C}$, tumble dry (permanent press)).

12.3 Report the brand, sodium hypochlorite activity, and amount of the chlorine bleach used.

12.4 Report the available chlorine content delivered to the wash by the dosage (see 14.8.3).

12.5 Report the weight of fabric specimen or garment tested, if other than found in 8.1.

12.6 Report the number of wash cycles tested, if other than 5.

12.7 Report water hardness.

12.8 If the information gained through this testing is to be used in establishing care instructions, results of washing using detergent and non-chlorine bleach, detergent alone or water alone may have to be included (see 5.1 and 9.6).

13. Precision and Bias

13.1 Precision.

13.1.1 In 2001 a single laboratory study was performed. The same operator tested all samples.

13.1.2 Samples tested consisted of three fabrics dyed with three different dyes. Washing conditions tested consisted of 60°C and 49°C wash temperatures. Both tests used 200 ppm levels of sodium hypochlorite. Each sample was evaluated instrumentally three times and

averages were calculated.

13.1.3 *Within-laboratory* Standard Errors and Critical Differences are shown in Table IV. Data are on file at the AATCC Technical Center.

13.2 *Bias*. The colorfastness to chlorine bleach in home laundering can be defined only in terms of a test method. There is no independent method for determining the true value. As a means of estimating this property, the method has no known bias.

14. Notes

14.1 Available from Publications Office, ACGIH, Kemper Woods Center, 1330 Kemper Meadow Dr., Cincinnati OH 45240; tel: 513/742-2020.

14.2 While the design of this method is to expose specimens to 5 cycles of washing and drying, the number of cycles may be shortened or lengthened if the end point is a specific grade for color change.

14.3 Contact AATCC, P.O. Box 12215, Research Triangle Park NC 27709; tel: 919/549-8141; fax: 919/549-8933, for model number(s) and source of current approved washer(s). Any other washer which is known to give comparable results may be used. Washing machine conditions given in Table II represent the actual speeds and times available on current specified model(s). Other washers may vary in one or more of these settings.

14.4 Contact AATCC (see 14.3) for model number(s) and source(s) of current approved dryer(s). Any other dryer which is known to give comparable results can be used. Dryer machine conditions given in Table III represent the actual speeds and times available on current specified model(s). Other dryers may vary in one or more of the settings.

14.5 Screen or perforated conditioning/drying racks available from Somers Sheet Metal Inc., 5590 N. Church St., Greensboro NC 27455; tel: 336/643-3477. Drawings of racks are available from AATCC (see 14.3).

14.6 Available from Textile Innovators Corp., div. of SDL Atlas L.L.C., P.O. Box 8, 101 Forest St., Windsor NC; tel: 252/794-9703; fax: 252/794-9704; e-mail: tic@

sdlatlas.com; or Testfabrics, P.O. Box 26, 415 Delaware St., W. Pittston PA 18643; tel: 570/603-0432; fax: 570/603-0433; e-mail: testfabric@aol.com.

14.7 Available from AATCC (see 14.3).

14.8 Use sodium hypochlorite bleach purchased within the last six months. Keep the bleach sealed in an airtight container and in a cool, dry place.

14.8.1 To confirm the sodium hypochlorite bleach's activity, weigh 2.00 g sodium hypochlorite into an Erlenmeyer flask and dilute to 50 mL with deionized water. Add 10 mL of 10% sulfuric acid and 10 mL of 10% potassium iodide. Titrate with 0.1N sodium thiosulfate until colorless.

Calculation:

% sodium hypochlorite =

$$\frac{\text{mL Na}_2\text{S}_2\text{O}_3(0.1N)(0.03722)}{2.0 \text{ g NaOCl}} \times 100$$

The factor 0.03722 is derived by multiplying the molecular weight of NaOCl (74.45 g/mol) by 0.001 (mL to L conversion) and dividing by 2 (mols of thiosulfate per hypochlorite).

14.8.2 Oxidizing power of sodium hypochlorite is typically expressed in terms of available chlorine, the equivalent amount of diatomic chlorine present. A 5.25% NaOCl solution contains 50,000 ppm available chlorine.

14.8.3 To determine the available chlorine delivered to the wash solution, weigh a 50 g wash water sample into an Erlenmeyer flask. Add 10 mL of 10% sulfuric acid and 10 mL of 10% potassium iodide. Titrate with 0.01N sodium thiosulfate until colorless.

Calculation:

ppm available chlorine =

$$\frac{\text{mL Na}_2\text{S}_2\text{O}_3(0.01N)(35.45)(1000)}{(50 \text{ g wash water sample})}$$

NOTE: No buffering agent is required since the solution is already buffered by the detergent.

14.9 ASTM methods available from ASTM, 100 Barr Harbor Dr., West Conshohocken PA 19428; tel: 610/832-9500; fax: 610/832-9555.

Table IV—Within-Laboratory Standard Errors and Critical Differences* (95% Probability) n-3)

Wash Temperature	Average DE*	Standard Error	Critical Difference
60°C wash	22.19	0.22	0.61
49°C wash	19.56	0.31	0.86

*Note: In this single laboratory test, estimates of standard error and critical differences may be either underestimated or overestimated to a considerable extent and should be used with special caution. The values should be viewed as minimal data with regards to precision. Confidence intervals are not well established.

Fluorine Content of Carpet Fibers

Developed in 2000 by AATCC Committee RA57; editorially revised and reaffirmed 2001; reaffirmed 2002; editorially revised 2005.

1. Purpose and Scope

1.1 This method is for determining the amount of fluorocarbon soil-resist agent present on carpet fibers by measurement of elemental fluorine on the pile fiber. It is useful for measurement of fluorocarbon present on carpet pile fiber as tested within the practical range of 100-1000 µg/g (ppm). It may also be used for yarns treated with fluorocarbon anti-soiling agents.

2. Principle

2.1 A weighed fiber specimen is burned in an oxygen combustion flask and the released hydrogen fluoride is absorbed into a sodium hydroxide solution. The fluorine content is measured as dissolved sodium fluoride at a constant pH and ionic strength using a fluoride ion activity electrode and a specific ion meter.

3. Terminology

3.1 **fluorine content**, *n*.—*in textile floor coverings*, the ratio of the weight of total elemental fluorine to the total weight of carpet fibers.

3.2 **soil resist agent**, *n*.—a material applied to, or incorporated in, carpet face fiber which retards and/or limits the build-up of soil.

4. Safety Precautions

NOTE: These safety precautions are for information purposes only. The precautions are ancillary to the testing procedures and are not intended to be all inclusive. It is the user's responsibility to use safe and proper techniques in handling materials in this test method. Manufacturers MUST be consulted for specific details such as material safety data sheets and other manufacturer's recommendations. All OSHA standards and rules must also be consulted and followed.

4.1 Good laboratory practices should be followed. Wear safety glasses in all laboratory areas.

4.2 All chemicals should be handled with care. Use chemical goggles or face shield, impervious gloves and an impervious apron during the dispensing and mixing of the fluoride and sodium hydroxide standards. The standards should be made and dispensed in a hood.

4.3 An eyewash/safety shower should be located nearby and a self-contained breathing apparatus should be readily available for emergency use.

4.4 Exercise care in cutting the specimens with the scalpel or razor blade; protective gloves may provide additional protection.

4.5 Oxygen supply pressure from the pressure regulator should not exceed 14 kPa (2 psi).

4.6 Do not operate the test equipment until the manufacturer's operating instructions have been read and understood. It is the responsibility of whoever operates the test equipment to conform to the manufacturer's directions for safe operation.

4.7 Exposure to chemicals used in this procedure must be controlled at or below levels set by governmental authorities (e.g., Occupational Safety and Health Administration's [OSHA] permissible exposure limits [PEL] as found in 29 CFR 1910.1000 of January 1, 1989). Fluoride salts and sodium hydroxides are listed with OSHA permissible exposure limits [PEL]. In addition, the American Conference of Governmental Industrial Hygienists (ACGIH) Threshold Limit Values (TLVs) comprised of time weighted averages (TLV-TWA), short term exposure limits (TLV-STEL) and ceiling limits (TLV-C) are recommended as a general guide for air contaminant exposure which should be met (see 12.1).

5. Apparatus, Reagents, Materials

5.1 1000 mL combustion flask with ball stopper (with platinum wire hook) and clamp (one each per specimen; reusable).

5.2 Platinum carrier basket (one per sample; reusable).

5.3 Infrared ignition cabinet.

5.4 Black paper specimen wrappers (one per sample).

5.5 Specific ion meter.

5.6 Fluoride ion selective electrode.

5.7 Reference electrode.

5.8 0.001*N* Sodium Hydroxide (NaOH).

5.9 TISAB (Total Ionic Strength Adjustment Buffer with CDTA (1,2-cyclohexanediaminetetraacetic acid) or formulated for fluorine analysis to prevent aluminum interference) (see 12.2).

5.10 Re-pipette or bottle-top dispenser (optional).

5.11 Sodium Fluoride (NaF) standard (see Appendix A).

5.12 Mechanical shaker (optional).

6. Calibration

6.1 Calibrate the specific ion meter using the procedures described in the operation manuals for the fluoride ion activity electrode and the specific ion meter. Calibrate the voltage output on the specific ion meter to read 40.0 for every 1 µg/g (ppm) fluoride in the standard solution (see 12.3, 12.4). Calibration should be done on a daily or every shift basis.

7. Sampling

7.1 Prepare the yarn sample by removing the tufts from the carpet sample with a scalpel or razor blade. Cut the tufts as close to the primary backing as possible having a stubble not greater than 1 mm. Twenty to 40 tufts are required for a single sample, depending on carpet construction. Place the tufts in a paper envelope and identify by test number.

7.1.1 *Sampling Option #1*. To determine an overall average fluorine content of carpet fibers, take samples from across the entire width of the carpet to compensate for possible variability in application and combine the tufts in a single envelope.

7.1.2 *Sampling Option #2*. To determine the variability of fluorine content across a carpet sample, take multiple samples from various areas of the carpet and analyze each set of carpet tufts separately (see 12.5).

8. Procedure

8.1 Weigh samples using tared weighing pans. Weigh between 0.110 g and 0.150 g of randomly selected tufts from each sample and record the weight. Fold all of the weighed tufts into the black paper sample holder and place the paper holder into the platinum basket. Suspend the basket from the platinum wire hook on the flask stopper.

8.2 Number each combustion flask and plastic cup.

8.3 Pipette 20.0 mL of the 0.001*N* sodium hydroxide solution into the oxygen combustion flask (see 12.6).

8.4 Turn on the oxygen supply. Place the flexible plastic tube into the oxygen combustion flask. Turn on the pressure regulator and allow oxygen to fill the flask for about 5-20 s. Turn off the oxygen flow (see 12.7).

8.5 Immediately place the flask stopper with the platinum basket suspended from the hook on the flask and clamp in place. Do not allow the sample basket to become wet or the sample will not ignite.

8.6 Place the flask in the infrared ignition cabinet. Adjust the flask level so that the test specimen in the suspended platinum basket is in the center of the infrared light beam and the tab on the black paper exposed to the infrared light. Turn on the infrared light until the sample ignites. Turn off the infrared light once the sample ignites. Allow the flame to burn out. Do not open the cabinet until the flaming has completely ceased. Confirm that the test specimen has burned completely. If any portion of the sample remains unburned, abort the test. Remove the flask from the ignition cabinet using a flask grip or gloves, as the flask will be hot.

8.7 Shake the flask.

8.7.1 If a mechanical shaker is used, place the flask into the holder and secure into position. Turn on the mechanical shaker for 1.5-2 min. Remove the flask.

8.7.2 If shaking is done by hand, shake vigorously for a minimum of 1 min.

8.8 Open the flask and pour all of the sodium hydroxide solution into a 100 mL plastic cup labeled with the test number.

8.9 Dispense 20.0 mL of TISAB into the empty flask. When dispensing, lift the flask stopper as little as possible to prevent any loss of gases. Replace the stopper and clamp in place. Repeat step 8.7 above. Pour all of the TISAB solution into the cup containing the sodium hydroxide solution.

8.10 Remove the platinum basket from the solution using tweezers. Cover the cup and allow the mixture to cool by sitting at room temperature for a minimum of 30 min.

8.11 Place the fluoride ion activity and reference electrodes into the cup containing the cooled test solution from the flask. Stir slowly and allow the meter to stabilize. Read and record the meter reading alongside the sample weight (see 12.8).

8.12 Discard the solutions in the plastic cups and to prevent cross-contamination, do not reuse the cups. Wash the platinum baskets and glassware, rinse with deionized or distilled water, and dry prior to using in a new test.

9. Calculation

9.1 Calculate the results as follows (if calibrated according to 6.1):

Fluorine content on carpet fiber $\mu\text{g/g}$ (ppm) =

$$\frac{\left[\begin{array}{c} \text{Meter reading (millivolt)} \\ \text{from step 8.11 above} \end{array} \right]}{\left[\text{sample weight (grams)} \right]}$$

9.1.1 Measured levels of less than 100 $\mu\text{g/g}$ (ppm) fluorine are considered as background levels and below the detection limit of this method.

10. Precision & Bias

10.1 *Interlaboratory test data.* An interlaboratory study was conducted in 1998 utilizing eight laboratories and two nylon face fiber carpets. Each laboratory made five determinations from each specimen using a single operator.

10.2 *Components of variance.* The components of variance shown as variances and the square root of the variances (to show appropriate units of measure) are listed in Tables I and II.

10.3 *Precision parameters.* For the components of variance reported in Table I, two averages of observed values should be considered significantly different at the 95% probability level if the difference equals or exceeds the critical differences listed in Table II.

10.3.1 Because only two carpets were used in this evaluation, users of the test method are advised to apply statistical caution in comparison of other carpets.

10.4 *Bias.* Fluorine content can be defined only in terms of a test method. While there are other independent means to determine fluorine content, any bias of this method in comparison to them have not been established.

11. Report

11.1 Report carpet description and date of testing.

11.2 Report any variation from procedure.

11.3 Report test result from 9.1.

12. Notes

12.1 Available from Publications Office, ACGIH, Kemper Woods Center, 1330 Kemper Meadow Dr., Cincinnati OH 45240; tel: 513/742-2020.

12.2 Total Ionic Adjustment Buffer (TISAB) is available from most laboratory supply companies. The buffer solution contains the following: sodium citrate, sodium hydroxide, acetic acid and water.

12.3 These calibrations of the electrode and meter simplify the calculations of fluorine content on carpet fibers. This 40:1 ratio accounts for the dilution of the hydrogen fluoride gas in the 40 mL of sodium hydroxide and TISAB solution.

12.4 In keeping with standard laboratory practices, two-point calibrations across the range to be tested give better precision and accuracy in determining fluoride content of solutions. For example, a two-point calibration may use 1 $\mu\text{g/g}$ (ppm) and 3 $\mu\text{g/g}$ (ppm) fluoride standards for 40.0 and 120.0 voltage output meter readings, respectively.

12.5 In order to prevent confusion, a sample numbering system should be established wherein all items to be used with a specific test specimen are numbered the same; i.e., paper envelopes, plastic cups, combustion flasks, etc.

12.6 For convenience in processing large numbers of samples, re-pipette dispensers may be used for the stock solutions of sodium hydroxide and TISAB buffer. If so, they should be checked for calibration daily.

12.7 The pressure from the pressure regulator should not exceed 14 kPa (2 psi). Exces-

Table I—Components of Variance for Fluorine Content (Expressed as Variances and Standard Deviations^a)

Component	Variance	Standard Deviation $\mu\text{g/g}$ (ppm)
Specimens within materials and laboratories	630.0	25.1
Laboratories	378.0	19.4
Interaction: Materials times laboratories	59.6	7.7

^aSquare roots of the components of variance are reported to express the variability in the appropriate units of measure rather than as the squares of those units of measure.

Table II—Critical Differences for the Conditions Noted 95% Probability Level, Single Material Comparisons $\mu\text{g/g}$ (ppm) Fluorine

Number of Test Results in each Average	Within-Laboratory Precision		Between-Laboratory Precision	
	Standard Error	Critical Difference	Standard Error	Critical Difference
1	25.1	70	31.7	88
2	17.8	49	26.3	73
3	14.5	40	24.2	67
4	12.6	35	23.1	64
5	11.2	31	22.4	62
7	9.5	27	21.6	61
9	8.9	23	21.2	59

NOTE 1—The tabulated values of the critical differences should be considered to be a general statement, particularly with respect to between-laboratory precision.

sive pressure may cause splashing.

12.8 Keep the electrodes immersed in the 2 $\mu\text{g/g}$ (ppm) fluoride standard solution when not in use in order to maintain electrode conditioning.

Appendix A—Standard Preparation

A1 Examples of fluoride standards:

A1.1 2000 $\mu\text{g/g}$ (ppm) fluoride standard: Weigh 4.4200 ± 0.0001 g of oven dried sodium fluoride (NaF) and transfer to a 1 L volumetric flask. Add distilled

water to the 1 L mark and shake until dissolved.

A1.2 20 $\mu\text{g/g}$ (ppm) fluoride standard: Pipette 10.0 mL of the above 2000 $\mu\text{g/g}$ (ppm) solution into a 1 L volumetric flask. Add distilled water to the 1 L mark and shake.

A1.3 2 $\mu\text{g/g}$ (ppm) fluoride standard: Pipette 100.0 mL of the 20 $\mu\text{g/g}$ (ppm) fluoride solution into a 1 L volumetric flask. Add distilled water to the 1 L mark and shake.

A1.4 0.001*N* sodium hydroxide solution: Pipette 2.00 mL of 0.500*N* NaOH into a 1 L volumetric flask. Fill to the 1 L mark with distilled water and shake.

Appendix B—Maintaining Laboratory Level

B1 It is strongly suggested that nylon fiber with known amount of non-volatile fluorocarbon treatment be used to develop and maintain a control chart of testing.

Colorfastness to Home Laundering with Activated Oxygen Bleach Detergent: Accelerated

Developed in 2001 by AATCC Committee RA60; reaffirmed 2002, 2003. Partly equivalent to ISO 105-C09.

1. Purpose and Scope

1.1 This test method is a diagnostic test intended to screen dyed cotton textiles sensitive to oxygen bleach detergents. It provides an accelerated procedure to assess the shade changes of dyed textiles when exposed to activated oxygen bleach detergent (simulating multiple home launderings, typically 10 or more). This procedure is most appropriately used during the dye selection process, prior to the production of washable textiles.

1.2 This method does not reflect the contribution to shade change of optical brighteners, which are present in some commercial washing products, or finishes that may be applied to the textile during production.

2. Principle

2.1 A specimen of the dyed textile is laundered, rinsed, and dried. Specimens are tested under defined conditions of temperature, bleach concentration and time to assess whether fading will occur after multiple home launderings. The color difference between the test specimen and the original textile is assessed instrumentally or visually.

3. Terminology

3.1 **activated oxygen bleach**, n.—a bleaching system comprising an oxygen bleach and a bleach activator.

3.2 **bleach activator**, n.—a bleach agent precursor, which converts a less potent bleaching species into a more powerful one.

3.3 **colorfastness**, n.—the resistance of a material to change in any of its color characteristics, to transfer of its colorant(s) to adjacent materials, or both, as a result of the exposure of the material to any environment that might be encountered during the processing, testing, storage or use of the material.

3.4 **laundering**, n.—of *textile materials*, a process intended to remove soils and/or stains by treatment (washing) with an aqueous detergent solution and normally including subsequent rinsing, extracting and drying.

3.5 **oxygen bleach**, n.—a bleach agent which can liberate hydrogen peroxide by

hydrolysis upon dissolving in water.

4. Safety Precautions

NOTE: These safety precautions are for information purposes only. The precautions are ancillary to the testing procedures and are not intended to be all inclusive. It is the user's responsibility to use safe and proper techniques in handling materials in the test method. Manufacturers MUST be consulted for specific details such as material safety data sheets and other manufacturer's recommendations. All OSHA standards and rules must also be consulted and followed.

4.1 Good laboratory practices should be followed. Wear safety glasses in all laboratory areas.

4.2 All chemicals should be handled with care.

4.3 The 1993 AATCC Standard Reference Detergent WOB may cause irritation. Care should be taken to prevent exposure to skin and eyes.

4.4 Use suitable gloves when handling hot canisters.

4.5 An eyewash/safety shower should be located nearby for emergency use.

4.6 Manufacturer's safety recommendations should be followed when operating laboratory testing equipment.

5. Apparatus, Reagents and Materials

5.1 Apparatus

5.1.1 An accelerated tester used for rotating closed canisters in a thermostatically controlled ($\pm 2^\circ\text{C}$ of prescribed temperature) water bath at 40 ± 2 rpm (see 12.1).

5.1.2 Stainless steel lever lock canisters (see 12.1) 550 ± 50 mL, 75×125 mm. For heavy weight fabrics, stainless steel lever lock canisters (see 12.1) 1200 mL, 90×200 mm may be used.

5.1.3 Teflon fluorocarbon gaskets, optional (see 7.5.2, 12.1 and 12.2).

5.1.4 Preheater/storage module, optional (see 7.5, and 12.1).

5.1.5 NOTE: Steel balls are NOT used in this testing.

5.2 Suitable colorimeter, spectrophotometer or AATCC Gray Scale for Color Change (see 12.4).

5.3 Reagents and Materials

5.3.1 1993 AATCC Standard Reference Detergent (without fluorescent whitening agent and without phosphate) (see 10.3 and 12.5).

5.3.2 Bleach activator (see 12.6).

5.3.3 Sodium perborate monohydrate (PB1) (see 12.4).

5.3.4 Water, distilled or deionized having <15 ppm hardness.

5.3.5 Balance, accurate to ± 0.01 g.

5.3.6 Electric or automatic stirrer.

5.3.7 Blotting paper.

5.3.8 Screen or drying rack.

5.3.9 White cards (specimen mounts) with *Y* tristimulus value at least 85%.

6. Test Specimens

6.1 Prepare a 50×100 mm specimen of the sample being tested. Woven fabrics may be stitched around edges with colorfast (preferably white) thread to prevent raveling.

6.2 Yarn may be knit on an appropriate sample knitting machine.

6.3 Keep one specimen of each sample as an unwashed original.

6.4 Weigh the specimen using the balance (see 5.3.5) to aid in accurate liquor ratio volumes.

6.5 Test only one specimen in each canister.

6.6 Three replicates are advised for improved precision. Replicates should be tested in separate accelerated test cycles.

7. Procedure

7.1 Adjust the accelerated tester to maintain $20 \pm 2^\circ\text{C}$.

7.2 A minimum of 1 L detergent solution should be prepared and freshly made immediately prior to each accelerated test.

7.3 Prepare the wash liquor by dissolving 10 g of the 1993 AATCC Standard Reference Detergent (WOB) powder (see 5.3.1) plus 4 g bleach activator (*100% activity*) (see 12.6) and 3 g sodium perborate monohydrate (PB1) per liter of water (see 5.3.4). Preheat this solution to $20 \pm 2^\circ\text{C}$ and stir with electric/automatic stirrer for 10 ± 1 min to ensure thorough dispersion of chemicals. The level of bleach activator can vary according to identity and level of bleach activation desired.

7.4 Add to each accelerated test canister the appropriate volume of wash liquor to provide a liquor:specimen ratio of 100 mL wash liquor:1 g of fabric. (Test one specimen per accelerated test canister.)

7.5 Two options for preheating the canisters to the test temperature are acceptable. Use either the accelerated tester or the preheater/storage unit. If the canisters

are to be preheated in accelerated tester, proceed to 7.5.2.

7.5.1 Place the canisters in the pre-heater module at $20 \pm 2^\circ\text{C}$. They are to remain in the module for at least 2 min. Enter a test specimen into each canister.

7.5.2 Clamp the covers on the canisters. A Teflon fluorocarbon gasket (see 5.1.3) may be inserted between the neoprene gasket and the top of each canister to prevent contamination of the wash solution by the neoprene. Fasten the 75×125 mm lever lock canisters in the adapters on the rotor of the accelerated tester. Place an equal number of canisters on each side of the shaft. For canisters preheated in the module, proceed to 7.8.

7.6 Start the rotor and run for at least 2 min to preheat the canisters.

7.7 Stop the rotor and with a row of canisters in an upright position, unclamp the cover of one canister, enter a test specimen into the solution and replace the cover, but do not clamp it. Repeat this operation until all the canisters in the row have been loaded. Then clamp the covers in the same order in which the canisters were loaded (delay clamping the covers to allow equalization of pressure). Repeat this operation without stopping until all rows of canisters have been loaded.

7.8 Close the container and commence rotation immediately after all canisters have been loaded.

7.9 Increase the temperature at a maximum of $2^\circ\text{C}/\text{min}$ to $60 \pm 2^\circ\text{C}$ and continue to run for a further 30 min at $60 \pm 2^\circ\text{C}$.

7.10 Stop the machine, remove the canisters and empty the contents into beakers keeping each test specimen in a separate beaker. Rinse each test specimen three times, in beakers, in water (see 5.3.4) at $40 \pm 3^\circ\text{C}$ for 1 min periods with occasional stirring or hand squeezing.

7.11 Squeeze the test specimen by hand to remove the excess water.

7.12 Dry the specimen by hand pressing flat between blotting papers to remove excess water. Then lay the specimen flat on a drying rack or screen not exceeding 60°C .

7.13 Allow the specimens to condition at $65 \pm 2\%$ RH and $21 \pm 1^\circ\text{C}$ for 1 h before evaluating.

7.14 Prepare tested fabric specimens for evaluation by trimming off raveled yarns and lightly brushing off any loose fiber and yarn on the fabric surfaces. Brush pile fabric specimens in required direction to restore them as nearly as possible to the same pile angle as the untreated specimens. Specimens should be hand smoothed or flattened if they are wrinkled due to washing and/or drying. Specimens may be mounted on cards to facilitate identification and handling in their evaluation. For consistency in backing material, use a white mounting card

with Y tristimulus value of at least 85%. Mounting material must not be visible in the area to be viewed and must not interfere with rating as specified in AATCC Evaluation Procedure 7, Instrumental Assessment of the Change in Color of a Test Specimen.

8. Evaluation

8.1 Evaluation of color change.

8.1.1 The color change can be quantitatively determined by measuring the color difference between the unwashed sample and a test specimen using a suitable colorimeter or spectrophotometer with the appropriate software (see AATCC Evaluation Procedure 7, Instrumental Assessment of the Change in Color of a Test Specimen).

8.1.2 To evaluate the color change of the test specimens visually, follow Evaluation Procedure 1, Gray Scale for Color Change, using the Gray Scale for Color Change. For improved precision and accuracy the specimens should be rated by more than one rater.

9. Interpretation of Results

9.1 Results from the test are intended to estimate the sensitivity of dyed textiles to activated oxygen bleach detergent. This is an accelerated test, and in obtaining the required degree of acceleration some of the conditions, such as temperature, were purposely exaggerated. Laundry detergents, washers and dryers, laundry practices and fabrics continue to change (see monograph "Standardization of Home Laundry Test Conditions," elsewhere in this TECHNICAL MANUAL). Consequently, caution in interpreting test results is advised.

10. Report

10.1 Report the color change results determined in 8.1.

10.2 State the evaluation method (see 8.1.1 and 8.1.2) and scale used (refer to Evaluation Procedure 7 and AATCC Test Method 173, CMC: Calculation of Small Color Differences for Acceptability).

10.3 Report the detergent used (see 12.5).

10.4 Report which accelerated tester was used.

11. Precision and Bias

11.1 An interlaboratory test was conducted in 1999 to establish the precision of the test method. Testing was conducted under the normal atmospheric conditions of each laboratory. One operator at each of seven laboratories evaluated six dyed fabrics in three replications using the accelerated test method. Color change (CIELAB) was measured on a spectrophotometer using an aperture of 25.4 mm, illuminant $D_{65}/10^\circ$ observer. Components of variance and critical differences are outlined below of fabrics representing different sensitivities to activated oxygen bleach detergent.

11.2 Components of variance as standard deviations of $\Delta E^* \text{CIELAB}$ readings are given in Table I.

11.3 *Critical Differences.* For the component of variance in Table I for this interlaboratory test, two averages of observed value should be considered significantly different at the 95% probability level if the difference equals or exceeds the critical differences shown in Table II.

12. Notes

12.1 An accelerated tester, the Launder-Ometer (a registered trademark of AATCC), is available with accessories from SDL Atlas L.L.C., 1813A Associate Lane, Charlotte NC 28217; tel: 704/329-0911; fax: 704/329-0914; e-mail: info@sdlatlas.com.

Table I—Components of Variance

Dyed Fabric	Average ΔE^*	Single-Operator Component	Between-Laboratory Component
#1	1.21	0.185	0.487
#2	6.13	0.222	1.055
#3	18.16	2.27	10.936

Table II—Critical Differences

Dyed Fabric	Average ΔE^*	No. of Observations	Single-Operator Component	Between-Laboratory Component
#1	1.21	3	0.696	2.074
#2	6.13	3	0.761	2.975
#3	18.16	3	2.436	9.574

12.2 Teflon is a registered trademark of the DuPont Co., Wilmington DE 19898.

12.3 The preheater/storage unit may be a side unit to the accelerated tester or a separate module with its individual electric heater and thermostat to control water bath temperatures for heating containers and solutions prior to loading the accelerated tester.

12.4 Available from AATCC, P.O. Box 12215, Research Triangle Park NC 27709;

tel: 919/549-8141; fax: 919/549-8933; e-mail: orders@aatcc.org.

12.5 The 1993 AATCC Standard Reference Detergent WOB (without fluorescent whitening agent), a compact formulation, is the detergent to be used in this test method. The detergent is available from AATCC, P.O. Box 12215, Research Triangle Park NC 27709; tel: 919/549-8141; fax: 919/549-8933; e-mail: orders@aatcc.org.

12.6 The quantities of bleach activator used in this method are specifically for sodium nonanoyloxybenzene sulfonate. Other bleach activators do exist, but the levels used may differ from that of sodium nonanoyloxybenzene sulfonate. Sodium nonanoyloxybenzene sulfonate is available from AATCC, P.O. Box 12215, Research Triangle Park NC 27709; tel: 919/549-8141; fax: 919/549-8933; e-mail: orders@aatcc.org.

Acid Cellulase Enzymes, Effect of: Top Loading Washer

Developed in 2002 by AATCC Committee RA41; reaffirmed 2003; editorially revised and reaffirmed 2004; editorially revised 2005.

1. Purpose and Scope

1.1 This test method provides a simple testing procedure to evaluate the effect of acid cellulase enzymes on cellulose by laundering.

1.2 The evaluations are carried out as listed in Section 8.

1.3 Other cellulase enzymes, i.e., modified acid and neutral types, may be evaluated by this test procedure. However, the concentration, pH, and time should be followed as recommended by the enzyme supplier.

1.4 A specific concentration of enzyme, buffer, and detergent are required in the bath to achieve the desired improvements. Since this test method utilizes an automatic washing machine to simulate the action of rotary drum machines, paddle machines, or jets used in production type operations (that usually operate at low liquor ratios), the concentrations required in this test method are based on grams/liter (g/L), to compensate for the difference in liquor ratios.

2. Principle

2.1 This test method determines the reaction of cellulosic fabrics to treatment with acid cellulase enzymes. Such treatments usually result in improvements in the hand, drape, fuzz and pill appearance of cellulosic fabrics together with the removal of linters and immature/dead cotton fibers. The agitation in the washer simulates the action in rotary drum machines, paddle machines and jets.

3. Terminology

3.1 **cellulase enzyme**, n.—an enzyme that attacks cellulose.

4. Safety Precautions

NOTE: These safety precautions are for information purposes only. The precautions are ancillary to the testing procedures and are not intended to be all-inclusive. It is the user's responsibility to use safe and proper techniques in handling materials in this test method. Manufacturers MUST be consulted for specific details such as material safety data sheets and other manufacturer's recommenda-

tions. All OSHA standards and rules must also be consulted and followed.

4.1 Good laboratory practices should be followed. All chemicals should be handled with care. Wear safety glasses and rubber gloves when working with chemicals. Material Safety Data Sheets should be obtained for all the chemicals used in the method.

4.2 An eyewash/safety shower should be located nearby, and readily accessible in case of an emergency.

5. Apparatus

5.1 Automatic washing machine, (the term *top loading washer* used in this method is synonymous with an automatic washing machine) (see 10.1).

5.2 Automatic tumble dryer (see 10.1).

5.3 Ballast of 920 × 920 ± 30 mm (36 × 36 ± 1 in.) hemmed pieces of bleached cotton sheeting (Wash load ballast type 1), or 50/50 polyester/cotton plain weave (Wash load ballast type 3) (see 10.2 and 10.3).

5.4 Reagents

5.4.1 Nonionic detergent; linear alcohol with 9 moles of ethylene oxide.

5.4.2 Buffer AC, sodium acetate (see 10.3).

6. Test Specimens

6.1 Take four to eight garments, or four to eight full width fabric specimens, 0.9 m (1 yd) in length. It is recommended that the cut edges of fabric specimens be sealed by sewing or some other means.

6.2 Two to four garment/fabric specimens are to be used to run the test cycle with enzyme.

6.3 The other two to four garment/fabric specimens are to be used to run through the test cycle without enzyme, for comparison.

7. Procedure

7.1 Use very hot water setting at 60°C (140°F) as listed in the AATCC mono-

graph of standardized home laundry test conditions.

7.2 Set the home laundry machine on low, small load (12 gal water), approximately 41 kg (90 lbs.) water and hot wash/cold rinse temperature setting.

7.3 Fill the washer using the regular cycle (12 mins wash cycle).

7.4 Add a nonionic detergent (1/g/L); volume 40 mL and weight 40 gm.

7.5 Add sodium acetate buffer (6 g/L), volume 195 mL and weight 240 gm.

7.5.1 Stir well; pH 4.5-5.0 (if too high, add acetic acid. pH should not be below 4.5; if so, add caustic, 50%).

7.6 Add acid cellulase enzyme as shown in Table I.

7.6.1 For 100% cotton garments or fabrics, normally 1-2 g/L acid cellulase enzyme is recommended.

7.6.2 For 50/50 cotton/polyester blends, normally 1-2 g/L acid cellulase enzyme is still used since a certain enzyme concentration in the bath must be maintained to achieve the desired effect on the cotton portion of the fabric.

7.6.3 For linen garments or fabrics, and its blends, normally 0.25-0.50 g/L acid cellulase enzyme is recommended.

7.6.4 For rayon and lyocell garments or fabrics, normally 4 g/L acid cellulase enzyme is recommended. The acid cellulase enzyme attacks these fibers much slower; therefore, four wash cycles (48 min) is required.

7.7 Place the garments or fabrics together with ballast, if needed for good agitation, in the water. Two to four garments or two to four fabrics 0.9 m (1 yd length) is sufficient.

7.8 Start the washer and complete only the wash portion.

7.9 Repeat the complete wash cycle and let it continue through its rinse and spin cycles to the termination of the wash cycle. Note: It is necessary to expose the samples to 24 mins in the enzyme bath.

7.10 Remove test specimens and ballast immediately. Place in a tumble dryer ion Normal or cotton-sturdy setting. Operate the dryer until the total load is dry.

Table I—Acid Cellulase Enzyme Portions

Volume		Weight	Fiber Content of Test Specimens	Number of Wash Cycles
(g/L)	mL	Gm		
(0.5)	20	21.3	100% linen and its blends	2
(2.0)	80	85.0	100% cotton and its blends	2
(4.0)	160	170.0	rayon or lyocell	4

Note drying time. Remove the load immediately after the dryer stops. Avoid over drying.

8. Evaluation

8.1 Evaluate and compare the hand of tested specimens exposed to acid cellulase enzyme with that of tested specimens not exposed to acid cellulase enzyme using AATCC Evaluation Procedure 5, Fabric Hand: Guideline for the Subjective Evaluation of.

8.2 Visually compare the appearance of tested specimens exposed to acid cellulase enzyme with tested specimens not exposed to acid cellulase enzyme to determine the degree of improvement in fabric fuzz, pill appearance, and degree of removal of linters and immature/dead cotton fibers. Visual ratings should be identified as none, slight, distinct, or considerable differences or improvement.

8.3 If desired, determine the strength of tested specimens exposed to acid cellulase enzyme and compare with that of tested specimens not exposed to acid cel-

lulase using ASTM D 3786-87, Hydraulic Bursting Strength of Knitted Goods for Knits, and the current version of ASTM D 5035, Breaking Force and Elongation of Textile Fabrics-Strip Method for Woven Fabrics.

9. Precision and Bias

9.1 *Precision.* Precision for this test method has not been established. Until a precision statement is generated for this method, use standard statistical techniques in making any comparisons of test results for either *within-laboratory* or *between-laboratory* averages. Analysis of variance or *t*-tests may be used to compare averages. See any standard statistical text for more information.

9.2 *Bias.* The evaluation of acid cellulase enzymes in an automatic washing machine can be defined only in terms of a test method. There is no independent method for determining the true value. As a means of estimating this property, the method has no known bias.

10. Notes

10.1 Contact AATCC, P.O. Box 12215, Research Triangle Park NC 27709; tel: 919/549-8141; fax: 919/549-8933; e-mail: orders@aatcc.org, for model number(s) and source(s) of current approved washer(s) and dryer(s).

10.2 Ballast are available from Testfabrics Inc., P.O. Box 26, 415 Delaware St., W. Pittston PA 18643; tel: 570/603-0432; fax: 570/603-0433; e-mail: testfabric@aol.com; and Textile Innovators Corp., div. of SDL Atlas L.L.C., P.O. Box 8, 101 Forest St., Windsor NC; tel: 252/794-9703; fax: 252/794-9704; e-mail: tic@sdlatlas.com.

10.3 In addition to acting on the cellulose of the test specimens, the cellulase enzyme used in this test will also act on the cellulose content of the ballast fabric. Hence, ballast fabrics used in this method may not be reusable to the same extent as in other methods. It is, therefore, recommended that if ballast are reused, they be weighed prior to each use, to ensure that they have not incurred weight loss greater than 75% from their original weight. If they have, they should be replaced with new ballast.

10.4 Contact AATCC, P.O. Box 12215, Research Triangle Park NC 27709; tel: 919/549-8141; fax: 919/549-8933; e-mail: orders@aatcc.org.

Weather Resistance of Textiles: Sunshine-Arc Lamp Exposure With and Without Wetting

Developed in 2003 by AATCC Committee RA64; reaffirmed 2004, 2005.

1. Purpose and Scope

1.1 This test method provides a means for determining the weather resistance of textile materials.

1.2 The test options described below are applicable to fibers, yarns and fabrics and products made therefrom, including coated fabrics, whether natural, colored, finished or unfinished. Test options included are:

A—Sunshine-Arc Lamp Exposure with Wetting

B—Sunshine-Arc Lamp Exposure without Wetting

1.3 The use of these options does not imply, expressly or otherwise, an accelerated test for a specific application. The degree of correlation between any weather resistance test and the actual exposure in use must be determined mathematically and agreed upon by the contractual parties.

1.4 Test duration and performance evaluation procedures are covered in material specifications agreed upon by the contractual parties.

1.5 This test method contains the following sections that assist in the use and implementation of the various options for determining the weather resistance of textiles.

	Section
Principle	2
Terminology	3
Safety Precautions	4
Uses and Limitations	5
Apparatus and Materials	6
Comparison Standards	7
Calibration and Verification	8
Test Specimen Preparation	9
Test Specimen Mounting	9.1
Conditioning	10
Preparation of Apparatus	11
Procedure	12
Evaluation	13
Report	14
Precision and Bias	15
Reference	16
Notes	17
Specimen Size and Preparation	Table I
Machine Start-Up Conditions by Cycles	Table II

Specification of test specimens for the breaking strength	Table III
Precision all Cycles, Breaking Strength, N	Table IV
Specification of test specimen for the color measurement	Table V
Precision all Cycles, Colorfastness, ΔE	Table VI
Apparatus and Materials, Machine Exposure	Appendix A
Suggested Machine Calibration and Maintenance Schedule	Appendix B

2. Principle

2.1 Test specimens and the agreed upon comparison standard(s) are exposed simultaneously to light source under specified conditions of either relative humidity or wetting. The amount of exposure is determined with respect to a specified degree of degradation such as color change, strength loss, etc. The weather resistance of the specimen is evaluated by comparison of a specified degradation of exposed portion of the test specimen to the unexposed original material: using one or more of the procedures recommended in this test method.

3. Terminology

3.1 AATCC Blue Wool Lightfastness Standard, n.—one of a group of dyed wool fabrics distributed by AATCC for use in determining the amount of light exposure of specimens during lightfastness testing.

NOTE: Because of the unstable nature of these materials they are also sensitive to the heat and moisture conditions which exist before exposure testing, after exposure testing, and prior to measurement.

3.2 Black Panel Thermometer, n.—a temperature measuring device, the sensing unit of which is coated with black designed to absorb most of the radiant energy encountered in lightfastness testing.

NOTE: This device provides an estimation of the maximum temperature a specimen may attain during exposure to natural or artificial light (see 17.1).

3.3 breaking strength, n.—the maximum force applied to a specimen in a tensile test carried to rupture.

3.4 bursting strength, n.—the force or

pressure required to rupture a textile by distending it with a force applied at right angles to the plane of the fabric, under specified conditions.

3.5 color change, n.—as used in colorfastness testing, a change in color of any kind (whether a change in hue, chroma, or lightness).

3.6 irradiation, n.—the time integral of irradiance expressed in joules per square meter (J/m^2).

3.7 laboratory sample, n.—a portion of material taken to represent the lot sample, or the original material, and used in the laboratory as a source of test specimens.

3.8 reference fabric, n.—one or more blue wool lightfastness standards selected for exposure as a check on a test apparatus and operating conditions.

3.9 reference plastic, n.—a clear polystyrene plastic standard selected for exposure as a check on a test apparatus and operating conditions.

NOTE: It has not been verified that these reference materials can be used as a check on a test cabinet or operating conditions for outdoor exposure tests due to seasonal variations in ultraviolet, temperature, relative humidity, and time of wetness during the uncontrolled portion of the test (see 17.14).

3.10 specimen, n.—a specific portion of a material or a laboratory sample upon which a test is performed or which is selected for that purpose.

3.11 spectral energy distribution, n.—the variation of energy due to the source over the wavelength span of the emitted radiation.

3.12 standard atmosphere for testing textiles, n.—air maintained at $21 \pm 1^\circ C$ ($70 \pm 2^\circ F$) and $65 \pm 2\%$ relative humidity.

3.13 tearing strength, n.—the average force required to continue a tear previously started in a fabric.

3.14 weather, n.—climatic conditions at a given geographic location, including such factors as sunlight, rain, humidity and temperature.

3.15 weather resistance, n.—ability of a material to resist degradation of its properties when exposed to climatic conditions.

4. Safety Precautions

NOTE: These safety precautions are for information purposes only. The precautions are ancillary to the testing procedure.

dures and are not intended to be all inclusive. It is the user's responsibility to use safe and proper techniques in handling materials in this test method. Manufacturers MUST be consulted on specific details such as material safety data sheets and other manufacturer's recommendations. All OSHA standards and rules must also be consulted and followed.

4.1 Do not operate the test equipment until the manufacturer's instructions have been read and understood. It is the operator's responsibility to conform to the manufacturer's directions for safe operation.

4.2 The test equipment contains high intensity light source. The door of the test chamber must be kept closed when the equipment is in operation.

4.3 Before servicing light sources, allow 30 min for cool-down after lamp operation is terminated.

4.4 When servicing the test equipment, shut off both the off switch on the front panel and the main power disconnect switch. When equipped, ensure that the main power indicator light on the machine front panel goes out.

4.5 Daylight exposure of the skin and eyes for prolonged periods may be hazardous and therefore caution should be employed to protect these areas. Do not look directly at the sun under any circumstances.

4.6 Good laboratory practices should be followed. Wear prescribed safety glasses in all laboratory areas.

5. Uses and Limitation

5.1 Not all materials are affected equally by the same light source and environment. Results obtained by the use of any one test option may not be representative of those of any other test option or any end-use application has been established between contractual parties.

5.2 Radiation emitted by the open flame carbon arc contains significant levels of very short wavelength UV (less than 260 nm) and must be filtered. None of the filter types used changes the spectral power distribution of the open flame carbon arc to make it match daylight in the long wavelength UV or the visible light regions of the spectrum. Although these filters are specified in many tests because of historical precedent, they transmit significant energy below 300 nm (the typical cut-on wavelength for terrestrial sunlight) and may result in aging processes not occurring outdoors.

5.3 Option A is intended for use in evaluating the resistance to degradation of a textile and related material, including coated fabrics, when subjected to simulated weathering including wetting, and radiant energy factors, and are further intended to check the level of durability represented in a material specification.

Option B is intended for use in evaluating the resistance to degradation due to weathering and sunlight exposure under conditions where wetting is not a factor.

5.4 In interpreting the results of these test options, it should be remembered that resistance to degradation under simulated sunlight exposure is dependant upon such factors as:

5.4.1 The inherent properties of the material, its physical state, mass and compactness.

5.4.2 Spectral energy distribution and density of the radiant flux (from artificial source).

5.4.3 The temperature and relative humidity of the air about the textile specimen during exposure.

5.4.4 The effect of leaching or degradation of additive products, including fiber stabilizers, by rain or water sprays.

5.4.5 Atmospheric contaminants.

5.4.6 The action of additive finishes and colorants including spectral absorption characteristics.

5.4.7 Where applicable, the action of residual laundry or dry cleaning chemicals.

5.5 The relative rates of degradation of different textile materials do not necessarily change to the same degree as those factors themselves change. Consequently, the relative durability of textile and related materials under the varying conditions of use cannot be predicted with certainty with any one test. Therefore, it is common practice to investigate the durability of materials by exposure to the variety of conditions under which they can be used to arrive at a full understanding of the performance that can be expected from them.

5.6 Having once established the acceptability of a given material, subsequent lots of it can be rated by direct comparison between the test specimen and the initially accepted material using the agreed upon option(s) provided in this test method. Although these options lead to results that are in general agreement for the majority of textiles, they do not lead to the same result for all textiles. When significantly different levels of resistance to degradation are found between the natural sunlight and weather methods and their artificial (laboratory) counterparts, the results obtained from direct sunlight and the elements of the weather will be regarded as the level of durability of the particular material for the purposes of intended end use.

5.7 When using this test method, the test option selected should incorporate light, humidity, wetting and temperature effects based upon historical data and experience. The test option selected should also reflect expected end-use conditions associated with the material to be tested.

5.8 When using this test method, use a standard of comparison. This comparison

material should have a known history in terms of a change in property value after a specific exposure.

5.9 Variations in results may be expected when operating conditions are varied within the accepted limits of this method. Therefore, no reference shall be made to results from the use of this method unless accompanied by a report detailing the specific operating conditions and locations in conformance with Section 14.

5.10 In case of a dispute arising from differences in reported test results when using this test method for acceptance testing of commercial shipments, the purchaser and the supplier should conduct comparative tests to determine if there is a statistical bias between their laboratories. Statistical analysis is recommended for the investigation of bias. As a minimum, the two parties should take a group of test specimens that are as homogeneous as possible and that are from a lot of material of the type in question. Test specimens should then be randomly assigned in equal numbers to each laboratory for testing. The average results from the two laboratories should be compared using the appropriate Student's t-test and an acceptable probability level chosen by the two parties before testing is begun. If a bias is found and corrected or the purchaser and the supplier must agree to interpret future test results with consideration for the known bias.

6. Apparatus and Materials

6.1 If possible, install the test apparatus in a room where temperature and relative humidity are controlled to minimize the effects of air supply variations.

6.2 Sunshine-arc type exposure apparatus with means of providing water sprayed to the specimen (see 17.2 and Appendix A).

6.3 Sunshine-arc type exposure apparatus without providing water sprayed to the specimen (see 17.2 and Appendix A).

7. Comparison Standards

7.1 Standards for comparison must be determined and agreed upon by the contractual parties. They can be made of any suitable textile material where a history of strength degradation or color change rates are known, depending upon individual test needs. They must be exposed simultaneously with the test specimen to be investigated. The intent of these standards is to demonstrate uniformity between separate machine exposures or outdoor test locations. When test data of the exposed standards differ by more than 10% from the known data, the test apparatus machine malfunction, then the test standard should be questioned and re-evaluated. Test data obtained with ques-

tionable standards must be treated with caution and resolution provided with quantitative analysis.

7.2 When colorfastness is the sole evaluation criterion, Blue Wool Standards, as defined in AATCC Method 16, Colorfastness to Light (see Section 16.2.1), have been found acceptable for exposures without water spray (see 17.3). However, caution should be employed since the rate of fade of the Blue Wool Standards by any one method may not agree with other methods.

8. Calibration and Verification

8.1 Maintain and calibrate the apparatus described in the manufacturers instructions.

9. Test Specimen Preparation and Mounting

9.1 Specimen Preparation.

9.1.1 Prepare specimens for the specified test procedures of at least the size given in Table I. When applicable, cut specimens with the longer direction parallel to the warp or filling direction as required in a material specification or contract order.

9.1.2 Prepare specimens as required to meet the needs of the applicable test method given in Table I (see 17.4, 17.5, 17.6 and 17.7).

9.1.3 These dimensions are given as a general guide and in most cases will be adequate to perform the required evaluation. Certain materials may exhibit a dimensional change with respect to the exposure. The test equipment manufacturer, physical test apparatus and number of specimens required will affect the needed specimen size. In any event, the test procedures given in Table I should be reviewed to ensure sufficient specimens are exposed for individual needs.

9.1.4 Unless otherwise specified, test specimens shall be a maximum thickness of 25 mm (1 in.). For specimens over 25 mm (1 in.) thick, formed or configured

specimens, and large components, specific instructions must be agreed upon between the purchaser and the supplier.

9.1.5 When required to prevent raveling, the specimens may be edged using a flexible epoxy resin or similar material, or they may be edged by sewing, pinking or fusing.

9.1.6 Label each specimen. Replicant specimens are preferred to provide a record of the changes encountered at different radiant exposure levels. Retain an unexposed specimen for comparison to the exposed specimen.

9.2 Specimen Mounting.

9.2.1 Mount the specimens on frames which are installed in the test chamber without backing, unless otherwise specified (see 17.8).

9.2.2 Fabrics. Secure the specimens to the frames to hold them smoothly without curling of the edges. Fabrics may be stitched to a gauze backing. For colorfastness determinations, mount the specimens in frames as directed in AATCC Method 16.

9.2.3 Yarns. Wind yarns on frames. Only that portion of the yarns directly facing the radiant energy is tested for breaking strength. Single strand or multiple strand testing may be performed. When multiple strand testing may be performed, the yarns are wound on the frame closely packed to 2.5 cm (1.0 in.) width. The control specimens must contain the same number of strands as the specimen subjected to exposure. After the exposure has been completed and before the yarns are removed from the frame for testing, those yarns facing the light source are bound together using 2.0 cm (0.75 in.) wide masking or other suitable tape to maintain the closely packed arrangements on the exposure frame.

10. Conditioning

10.1 When the exposure cycle is completed, remove the test and control specimens from the exposure rack and transfer them to a standard atmosphere for testing

textiles for conditioning.

10.2 If the specimens are wet upon removal from the racks, dry them at ambient laboratory conditions or at a temperature not exceeding 71°C (160°F) before placing them in the conditioning atmosphere. The unexposed reference standard (comparison standard) and the retained unexposed original should be treated under exactly those same conditions of drying and conditioning as the test specimens.

10.3 Bring all specimens, control and test, to moisture equilibrium in the atmosphere for testing textiles. Equilibrium is considered to have been reached when the increase in mass of the specimen in successive weightings made at intervals of not less than 2 h does not exceed 0.1% of the mass of the specimen. In general practice, the industry approaches equilibrium from the 'as received' side.

10.3.1 It is recognized that, in practice, textile materials are frequently not weighed to determine when moisture equilibrium has been reached. While such a procedure cannot be accepted in cases of dispute, it may be sufficient in routine testing to expose the material to the standard atmosphere for testing for a reasonable period of time before the specimens are tested. Twenty-four hours has been found acceptable in most cases: however, certain fibers may exhibit slow moisture equalization rates from the "as received" wet side. When this is known, a preconditioning cycle, as described in ASTM Practice D 1776 may be agreed upon between contractual parties.

10.4 For each test to be made on the test material and control, exposed and unexposed, prepare test specimens by marking and raveling or cutting the central portion of each exposed specimen to the dimensions specified in the respective test methods given in Table I. The marking and raveling or cutting of the test specimens is preferred after the exposure but may be done before exposure. Control specimens not exposed are similarly prepared. For samples exposed are similarly prepared. For samples exposed with wetting, control specimens are wet-out and allowed to dry without tension before testing. All specimens, control and test, are conditioned simultaneously to the standard atmosphere for testing textiles for a minimum of 24 h and preferably longer, depending upon the material, and tested at the same time.

11. Preparation of Test Apparatus Machine Exposure

11.1 Prior to running a new set of conditions, operate the machine for 24 h to ensure conformance to the specified operating conditions as described in Table II. Verify the test apparatus temperature

Table I—Specimen Size and Preparation

Property	Test Method	Specimen Size
Breaking Strength:		
Strip Test	ASTM D 5034	5 × 20 cm (2 × 8 in.)
Grab Test	ASTM D 5035	13 × 28 cm (5 × 7 in.)
Single Strand	ASTM D 2256	15 cm (6 in.)
Bursting Strength:		
Woven Fabric	ASTM D 3786	15 × 15 cm (6 × 6 in.)
Nonwoven Fabric	ASTM D 3786	15 × 15 cm (6 × 6 in.)
Knit Fabric	ASTM D 3787	15 × 15 cm (6 × 6 in.)
Test Strength:		
Elmendorf	ASTM D 1424	10 × 13 cm (4 × 5 in.)
Trapezoid	ASTM D 1117	10 × 18 cm (4 × 7 in.)
Colorfastness	AATCC 16	3 × 6 cm (1.25 × 2.4 in.)

Table II—Machine Start-Up Conditions by Cycle

Component	Cycle			
	1	2	3	4
Cycle Duration, min	120	120	Continuous	120
Light Only, min	90	60	Continuous	102
Dark Only, min	0	60	0	0
Light & Water Spray, min	30	0	0	18
Black Panel Temperature	77 ± 3°C (170 ± 5°F)	77 ± 3°C (170 ± 5°F)	77 ± 3°C (170 ± 5°F)	63 ± 3°C (145 ± 5°F)
Relative Humidity, %				
Light Cycle	70 ± 5	70 ± 5	27 ± 3	50 ± 5
Water Spray Nozzles	F-80 (4)	None	None	F-80 (4)
Filter Type		Corex D		
Specimen Rack, rpm		1		
Light Source		Sunshine Open-Flame		
Carbon Type		Copper Clad		
Voltage				
Across Arc		50 V		
Power In		200 V		
Ampere		60 A		
Water Requirements (Input)				
Type		Demineralized, Distilled, or Reverse Osmosis		
Solid, ppm		One or Less		
PH		7 ± 1		
Temperature		Ambient 16 ± 5°C (61 ± 9°F)		

and relative humidity monitoring sensors at the start of each test (see 17.6 and Appendix B).

11.1.1 Turn off all rack and specimen spray units.

11.1.2 The Black Panel and Black Standard Thermometer units indicate the absorbed irradiance minus the heat dissipated by conduction and convection. Keep the black face of these thermometer units in good condition. When exposed in the test apparatus, it is subject to deterioration. Therefore, periodically clean and polish it with a high-grade automobile wax. Maintain a control thermometer unit to periodically check the operating thermometer unit for conformance. When an operating thermometer unit falls outside the limits established for the test procedure compared to the control unit, replace the unit.

11.1.3 Set machine operating conditions according to Table II and the specified option.

11.1.4 Program the test apparatus to achieve the specified cycle. Fill the specimen rack with blank or dummy specimens and the black panel thermometer unit. This simulated airflow in the test chamber during the test exposure and should not include the actual test specimens. Support the black panel thermometer unit in the specimen drum or rack in the same manner as the test specimen frames. When exterior indicators are not available, read the black panel thermometer unit through the window in the test chamber door. Operate and control the test apparatus as specified in Table II and further defined by the manufacturer. Operate the test apparatus in this mode and adjust the chamber dry and wet bulb tem-

peratures, or chamber thermometer and hygrometer, to provide the required black panel temperature and relative humidity.

11.1.5 Shut off the test apparatus after operating at the controlled conditions for a minimum of 24 h. Remove the blank or dummy specimens from the specimen rack.

12. Procedure

12.1 Mount the framed test specimens on the specimen rack. Make sure that all materials are adequately supported, both top and bottom, in proper alignment. Any displacement of the material toward or away from the source, even by a small distance, may lead to variation between specimens. The specimen rack must be filled: blank or dummy specimens are used when the number of specimens being tested is insufficient to fill the specimen rack. When alternate light and dark cycles are required, begin exposure at the start of the light cycle.

12.2 In the case of textile fabrics, unless otherwise specified, ensure that the side normally used as the face is directly exposed to the radiant source.

12.3 Check at regular intervals to ensure the apparatus provides the designated temperatures and relative humidity. When available, monitor exposure test chamber conditions with suitable recorders. If necessary, readjust the controls to maintain the specified test conditions and verify calibrations of the test apparatus.

12.4 Install the appropriate cycle cam from the agreed upon operating cycle.

12.5 **For Option A**, ensure that the water from the specimen spray strikes the test

specimens in the form of a fine spray equally distributed over the test specimens.

12.6 **For Option B**, ensure that specimen water sprays are turned off.

12.7 Ensure the current, voltage and water supply during the test meet the requirements of Table II. Ensure the test cycle provides the designated black panel temperature and relative humidity.

12.8 To ensure uniform total irradiation over the specimen surface, reposition specimens vertically in a sequence which will provide each specimen equivalent exposure periods in each location. When the exposure interval does not exceed 24 h, each specimen should be located equidistant from the horizontal axis of the arc. Unless otherwise specified, rotate the test specimens after each 250 h of exposure.

12.9 In some laboratories, the test apparatus is operated on a time cycle of continuous five days exposure followed by two days of rest (machine off) until the designated period of exposure is completed. This provides for operation during weekdays followed by non-operation on weekends, which is a normal schedule for many laboratories. In some laboratories, the test apparatus is operated on a continuous schedule. In any event, the operating schedule must be reported.

12.10 Operate the test apparatus continually until the carbons are consumed. Avoid unnecessary delays when carbons are changed and the exposure period continued, as such delays may contribute to variations in results or lead to errors.

12.11 Conduct physical test using the test methods listed in Section 16, as applicable (see 17.9).

12.12 Average the data for the various replicates, or handle statistically as appropriate, and record a significant value of breaking, tearing, or bursting strength retention and/or colorfastness after exposure in relation to original strength or color, as applicable. It is appropriate to record the percent elongation characteristics of the unexposed controls and exposed specimens at rupture or at some prescribed point in the force-elongation curve as this is frequently significant supplementary information.

13. Evaluation

13.1 Classify the durability or resistance to degradation of the material with respect to the standard of comparison by one of the following:

13.1.1 Percent Strength Retained or Percent Strength Loss. Record percent strength loss or percent strength retained (breaking, tearing, or bursting as appropriate) of the material after the prescribed exposure time period.

13.1.2 Residual Strength. Record the initial and final strength values along with all other pertinent data as above.

13.1.3 Colorfastness. Classify the colorfastness of the material as directed in AATCC Method 16, Option 6 (see 17.10).

13.2 In Terms of an Agreed Upon Comparison Sample or Standard. **Satisfactory:** As durable as or more durable than the comparison sample at the amount of radiant exposures and/or exposure time period prescribed in the material standard. **Unsatisfactory:** Less durable than the comparison sample at the amount of radiant exposure and/or exposure time period prescribed in the material standard.

13.3 For the purpose of defining the relative durability of a test material to an agreed upon comparison standard an index, S_nX , can be defined as the ratio of

the percent residual strength in the test specimen compared to be as resistant to degradation as the standard. With the index a specimen is considered to be as resistant to degradation as the standard when the S_nX value is 1; more durable when the S_nX index exceeds 1; less durable when the S_nX index is less than 1.

NOTE: An index of this nature has particular value when recording the relative durability of a series of materials to a common standard and can be actually more useful in research than in the routine assessment of the durability of materials for purpose of commerce.

14. Report

14.1 Use the following guide and report all applicable information:

14.2 Report any deviation from this test method or the performance of the comparison standard.

14.3 Report all information in 14.1 for the same conditions that the samples and reference materials are exposed.

14.4 Report all applicable properties evaluated in Section 13.

14.5 Report the direction of the test if not in warp direction.

15. Precision and Bias

15.1 *Interlaboratory Test Data, Breaking Strength Determination.* The sunshine carbon-arc test was convened by Suga Weathering Technology Foundation, and the exposure was carried out at five laboratories in Japan in 2000 and 2001.

The randomly drawn samples of four

Exposure Option Used (A or B) _____

Operators Name _____ Date _____

Sample Identification _____

Material exposed: Face _____ Back _____

Colorfastness to Light Rating _____

Lightfastness Classification: _____ No _____

Test Specimen Compared To: Masked Portion _____

Unmasked Portion _____

Unexposed Original _____

Colorfastness to Light Rating Determined By:

AATCC Gray Scale For Color Change _____

Instrumentally, Name Type _____

Classification Method: _____

Comparison Standard: _____

Temperature Controlled: By Ambient _____ °C

By Black Panel _____ °C

By Black Standard _____ °C

Exposure Controlled: By AATCC Blue Wool Lightfastness Standards _____

By Radiant Energy _____

Other _____

Total Radiant Energy _____

Type of Test Apparatus _____ Model number _____

Specimen Rack: _____ Inclined _____ 1-Tier _____ 3-Tier _____ Horizontal

Serial Number _____ Manufacturer's Name _____

Type of Water Supply _____

Option Employed _____ Elapsed Exposure Time _____

Mounting Procedure: Backed _____ Unbacked _____

Sample Rotation Schedule _____ Relative Humidity % _____

test fabrics and three specimen of each were exposed at the laboratories according to AATCC Test Method 111. All the machines start up conditions Cycle 1 to 4 in AATCC Test Method 111 were carried out. These conditions by Cycle are as in AATCC Test Method 111 and listed in Table III. And the specifications of the four test fabrics are in Table IV.

Each laboratory made the same test three times. The running hours of these tests were 230 h for all four Cycles. The test of the same cycle condition was repeated every 230 h. So, these *within-laboratory* and *between-laboratory* precision programs were performed in short-term repeats.

All the samples exposed were gathered

to Suga Weathering Technology Foundation, Technical committee, and measured by the same machine.

The breaking strength of all specimens was determined as directed in ASTM test method D 5035, Test method for Breaking Strength and Elongation of Textile fabrics (Strip method), using a constant rate of extension tensile tester in two directions.

Table III—Specification of Test Specimens for the Breaking Strength

	Textile		Dyestuff	Color Index	Color
A	Acrylic	Warp	Aizen Cation Blue K-GLH	Blended	Blue
		Woof			
B	Cotton	Warp	Remazol Brill. Orange 3R	C.I. Reactive Orange 16	Orange
		Woof			
C	Wool	Warp	Kayanol Milling Brown 4GW	C.I. Acid Brown 13	Brown
		Woof			
D	Polyamide (Nylon)	Warp	Kayanol Milling Red BW	C.I. Acid Red 138	Red
		Woof			

Table IV—Precision All Cycles Breaking Strength, *N*

Sample	Orientation	Test	Mean Level (<i>M</i>)	Within a Lab			Between Labs		
				Sr	r	CV% _r	SR	R	CV% _R
Acrylic	warp	cycle 1	337.26	8.43	23.60	7.00	8.43	23.61	7.00
		cycle 2	336.37	8.04	22.50	6.69	8.27	23.16	6.88
		cycle 3	333.58	8.79	24.61	7.38	9.52	26.66	7.99
		cycle 4	342.65	6.14	17.19	5.02	6.14	17.19	5.02
	woof	cycle 1	210.41	9.52	26.67	12.68	11.33	31.72	15.08
		cycle 2	215.06	6.90	19.33	8.99	6.90	19.32	8.98
		cycle 3	212.57	8.75	24.50	11.53	8.75	24.50	11.53
		cycle 4	213.26	8.59	24.05	11.28	8.99	25.17	11.80
Cotton	warp	cycle 1	276.30	16.68	46.72	16.91	16.68	46.70	16.90
		cycle 2	370.62	11.70	32.75	8.84	23.36	65.41	17.65
		cycle 3	307.00	10.52	29.47	9.60	16.65	46.62	15.19
		cycle 4	349.80	12.93	36.20	10.35	20.88	58.46	16.71
	woof	cycle 1	132.86	11.42	31.97	24.06	18.75	52.51	39.52
		cycle 2	162.40	10.30	28.83	17.75	15.55	43.54	26.81
		cycle 3	162.69	10.55	29.54	18.16	15.10	42.28	25.99
		cycle 4	170.81	11.16	31.25	18.30	14.95	41.86	24.51
Wool	warp	cycle 1	370.36	24.31	68.08	18.38	24.31	68.07	18.38
		cycle 2	380.37	17.11	47.91	12.60	25.62	71.74	18.86
		cycle 3	326.63	11.88	33.27	10.19	21.31	59.67	18.27
		cycle 4	410.40	13.31	37.27	9.08	13.31	37.27	9.08
	woof	cycle 1	323.18	19.82	55.50	17.17	26.03	72.88	22.55
		cycle 2	295.08	11.18	31.31	10.61	17.17	48.08	16.29
		cycle 3	244.79	11.23	31.44	12.85	12.73	35.64	14.56
		cycle 4	394.35	22.06	61.76	15.66	27.46	76.89	19.50
Polyamid	warp	cycle 1	59.14	4.40	12.32	20.84	4.40	12.32	20.83
		cycle 2	104.79	5.14	14.39	13.73	7.73	21.64	20.65
		cycle 3	51.24	4.64	13.00	25.37	4.64	12.99	25.36
		cycle 4	99.40	5.18	14.50	14.59	5.18	14.50	14.59
	woof	cycle 1	79.52	5.44	15.22	19.14	6.27	17.56	22.08
		cycle 2	122.46	5.28	14.80	12.08	8.18	22.90	18.70
		cycle 3	73.20	4.15	11.62	15.88	4.15	11.62	15.87
		cycle 4	114.28	7.07	19.80	17.33	8.49	23.77	20.80
Pooled or Average values	warp	cycle 1	260.76	13.46	37.68	14.45	13.46	37.68	14.45
		cycle 2	298.04	10.50	29.39	9.86	16.25	45.49	15.26
		cycle 3	254.61	8.96	25.09	9.85	13.03	36.48	14.33
		cycle 4	300.56	9.39	26.29	8.75	11.38	31.86	10.60
	woof	cycle 1	186.49	11.55	32.34	17.34	15.60	43.67	23.42
		cycle 2	198.75	8.42	23.57	11.86	11.95	33.46	16.84
		cycle 3	173.31	8.67	24.28	14.01	10.18	28.51	16.45
		cycle 4	223.17	12.22	34.22	15.33	14.97	41.92	18.78

Mean value, repeatability standard deviation S_r , 95% repeatability limit (in measurement units) r , repeatability coefficient of variation (in percent) (CV% r), reproducibility standard deviation S_R , 95% reproducibility limit (in measurement units) R , and reproducibility coefficient of variation (in percent) (CV% R) are used as specified in ASTM Practice E 177, Standard Practice for Use of the Terms Precision and Bias in ASTM Test Methods, and listed in Table IV.

15.2 Interlaboratory Test Data, Color Change Determinations. For the same Interlaboratory program described above, color measurements were made prior to and after the sunshine carbon arc exposure. Color change determinations were determined as directed in AATCC Evaluation Procedure 6. The specifications of the four test fabrics are in Table V. The running hours for the color measurement tests were 80 h for all four cycles.

Mean value, repeatability standard deviation S_r , 95% repeatability limit (in measurement units) r , repeatability coefficient of variation (in percent) CV% r , reproducibility standard deviation S_R , 95% reproducibility limit (in measurement units) R , and reproducibility coefficient of variation (in percent) CV% R are used

as specified in ASTM Practice E 177 and listed in Table VI.

15.3 Precision. 95% repeatability limit r and repeatability coefficient of variation CV% r of the breaking strength and color difference ΔE has been established. For example, the repeatability coefficient of variation CV% r of the color difference ΔE of Acrylic fabric tested by Cycle 1 was 9.77%. Two single measurements performed in the same laboratory that differ by more than 9.77% (expressed as percentage of their color difference, ΔE) must be considered suspect, i.e. having arisen from different sample population.

95% reproducibility limit R and reproducibility coefficient of variation CV% R of the breaking strength and color difference ΔE , has been established. The reproducibility coefficient of variation CV% R of the color difference ΔE of Acrylic fabric tested by Cycle 1, was 10.70%. Two single measurements performed in separate laboratories that differ by more than 10.70% (expressed as a percentage of their average value) must be considered as suspect, i.e. having come from different sample population.

15.4 Bias. An accepted reference value is not available; therefore, the bias cannot be established.

16. References

16.1 ASTM Standards (see 17. 11).

16.1.1 D 5034 Test Method for Breaking Strength and Elongation of Textile Fabrics (Grab Test).

16.1.2 D 5035 Test Method for Breaking Strength and Elongation of Textile Fabrics (Strip Test).

16.1.3 D 2256 Test Method for Tensile Properties of Yarns by the Single-Strand Method.

16.1.4 D 3787 Test Method for Bursting Strength of Knitted Goods.

16.1.5 D 3786 Test Method for Hydraulic Bursting Strength of Knitted Goods and Nonwoven Fabrics.

16.1.6 D 1424 Test Method for Tear Resistance of Woven Fabrics by Falling Pendulum (Elmendorf) Apparatus.

16.1.7 D 1117 Methods of Testing Nonwoven Fabrics, Trapezoid Tear Procedure.

16.1.8 G 24 Standard Practice for Conducting Exposures to Daylight Filtered through Glass

16.1.9 G 152 Standard Practice for Operating Open Flame Carbon-Arc Light Apparatus for Exposure of Nonmetallic Materials.

16.1.10 D 2905 Number of Specimens Required to Determine the Average Qual-

Table V—Specification of Test Specimens for the Color Measurement

	Textile	Dyestuff	Color Index	Color
A	Acrylic	Aizen Cation Blue K-GLH	Blended	Blue
B	Polyester	Kayacelon Yellow E-3GL	C.I. Disperse Yellow 64	Yellow
C	Polyamide (Nylon)	Lanyl Red B	C.I. Acid Red 215	Red
D	Wool	Suminol Leveling Sky Blue R extra conc	Acid Blue 62	Blue

Table VI—Precision All Cycles Colorfastness, ΔE

Sample	Test	Mean Level	Within a Lab			Between Labs		
			S_r	r	CV% r	SR	R	CV% R
Acryl	cycle 1	6.12	0.21	0.60	9.77	0.23	0.65	10.70
	cycle 2	2.52	0.11	0.31	12.29	0.11	0.31	12.29
	cycle 3	3.37	0.17	0.48	14.12	0.19	0.54	15.99
	cycle 4	4.97	0.15	0.43	8.72	0.25	0.69	13.87
Polyester	cycle 1	3.90	0.19	0.53	13.55	0.19	0.53	13.72
	cycle 2	2.74	0.10	0.27	9.83	0.18	0.50	18.20
	cycle 3	3.77	0.13	0.37	9.68	0.22	0.61	16.03
	cycle 4	2.55	0.12	0.34	13.25	0.32	0.91	35.47
Polyamid	cycle 1	6.20	0.27	0.75	12.12	1.24	3.48	56.19
	cycle 2	3.12	0.14	0.39	12.57	0.84	2.36	75.48
	cycle 3	5.15	0.09	0.24	4.71	0.72	2.02	39.15
	cycle 4	4.08	0.15	0.43	10.57	0.52	1.45	35.51
Wool	cycle 1	32.73	1.23	3.45	10.53	1.79	5.00	15.28
	cycle 2	15.14	0.57	1.59	10.47	1.04	2.92	19.29
	cycle 3	18.92	0.25	0.70	3.68	0.94	2.62	13.86
	cycle 4	27.06	0.47	1.31	4.82	1.07	3.00	11.08
Pooled or Average values	cycle 1	12.24	0.48	1.33	10.88	0.86	2.42	19.76
	cycle 2	5.88	0.23	0.64	10.87	0.54	1.52	25.88
	cycle 3	7.80	0.16	0.44	5.70	0.52	1.45	18.52
	cycle 4	9.67	0.22	0.63	6.49	0.54	1.51	15.63

ity of a Textile.

16.1.11 D 1776 Standard Practice for Conditioning and Testing Textiles.

16.2 AATCC Test Methods (see 17.3).

16.2.1 Method 16, Colorfastness to Light.

16.2.2 Evaluation Procedure 1, Gray Scale for Color Change.

16.3 SAE Test Methods (see 17.13).

16.3.1 J1545 Instrumental Color Difference Measurement for Exterior Finishes, Textiles, and Colored Trim.

16.4 ISO Test Methods (see 17.12).

17. Notes

17.1 For Black Panel Thermometers. Testing temperature is measured and regulated by a Black Panel Thermometer unit mounted on the specimen rack to permit the face of it to receive the same exposure as the test specimen. It consists of a 1 mm (0.038 in.) thick black stainless steel panel 70 × 150 mm (2.75 × 5.88 in.) to which is mechanically fastened a stainless steel bimetallic dial-type thermometer or resistance temperature device (RTD). The thermometer has a stem 4 mm (1.75 in.) in diameter with a 44 mm (1.75 in.) dial. The sensitive portion extending 38 mm (1.5 in.) from the end of the stem is located in the center of the panel 64 mm (2.5 in.) from the top and 48 mm (1.88 in.) from the bottom of the panel. The face of the panel with the thermometer stem attached should be finished with two coats of a baked-on black enamel selected for its resistance to light and water and should have at least 95% absorbency.

17.2 One or more of the test apparatus types and materials are available from SDL Atlas L.L.C., 1813A Associate Lane, Charlotte NC 28217; tel: 704/329-0911; fax: 704/329-0914; e-mail: info@sdlatlas.com; and Suga Test Instruments Co. Ltd., 5-4-14, Shinjuku, Shinjuku-ku, Tokyo, 160-0022, Japan; tel: +81 3 3354/5241; fax: +81 3 3354/5275.

17.3 Available from AATCC, P.O. Box 12215, Research Triangle Park NC 27709; tel: 91 9/549-8141; fax: 919/549-8933; e-mail: orders@aatcc.org

17.4 Unless otherwise agreed upon, as when specified in an applicable material specification, take a number of specimens such that the user may expect at the 95% probability level that the test result is not more than 5.0% of the average above the true average of the lot. Determine the number of specimens using standard deviation with one-sided limits as directed in ASTM Practice D 2905 (see 16.1.10).

17.5 Pile fabrics, such as carpets, which have fibers that may shift position, or texture which may make evaluations in small areas difficult should be tested with an exposed area of not less than approximately 40.0 mm (1.6 in.) × 50.0 mm (2.0 in.). Exposed sufficient size or multiple specimens to include all colors in the sample.

17.6 In some cases high humidity, in combination with atmospheric contaminants, has been found to produce property changes as great as those produced by light. When requested, prepare a duplicate set of test specimens and standards and expose simultaneously in another cabinet or rack of

the same type used in the light exposures but covered with an opaque material to exclude the light. Because there is a combined effect of light, temperature, humidity and atmospheric contaminants, it cannot be assumed that a comparison between specimens exposed in the covered cabinet and in the uncovered cabinet under glass will permit separating the effects produced by light only. However, a comparison of the two sets of specimens with a piece of the original which has not been an exposure cabinet will indicate whether a material is sensitive to moisture and atmospheric contaminants. This may also help to explain why different results may be obtained with the same amount of radiant energy in daylight exposures made at different times and at different locations.

17.7 In general, the warp direction is used, but the filling direction may be used to complete or in place of the warp direction when specified. Warp yarns sometimes are protected from the radiation due to fabric structure. When the filling direction is used, it must be reported.

17.8 Specimen frames must be made of stainless steel or suitably coated steel to avoid contaminating the specimens with metallic impurities that might catalyze or inhibit the degradation. When specimens are fastened with staples, they should be of the nonferrous type over-coated to avoid contamination of the specimen by corrosion products. Metal frames must have a dull finish and be designed to avoid reflectance that could influence the performance of the material. Frames shall conform to the curvature of the specimen rack. The size of the frame is determined by the type specimens required for individual property requirements.

17.9 Under certain conditions, by agreement between principals to a transaction, tearing strength of the material can be used in lieu of, or to complement, the breaking or bursting strength. The material specification may further define the use of wet breaking, tearing, or bursting strength tests in lieu of or to complement those tests done under standard textile testing conditions. Such conditions of test shall be reported along with the data.

17.10 A difference in color change properties between original material and the covered portion of the exposed specimen indicated that the textile has been affected by some agent other than light, such as heat or a reactive has in the atmosphere. Although the exact cause difference in color may not be known, it should be noted in the report when it occurs.

17.11 Available from ASTM, 100 Barr Harbor Dr., W. Conshohocken PA 19428-2959; tel: 610/832-9500; fax: 610/832-9555.

17.12 Available from American National Standard Institute Inc., 11 West 42nd St., New York 10036; tel: 212/642-4900; fax: 212/302-1286.

17.13 Available from Society of Automotive Engineers International, 400 Commonwealth Dr., Warrendale PA 10596-0001; tel: 412/776-4841.

17.14 Polystyrene Plastic Lightfastness Standard (PPLS) may be obtained from Testfabrics Inc., P.O. Box 26, 415 Delaware St., W. Pittston PA 18643; tel: 570/603-0432; fax: 570/603-0433; e-mail: testfabric@aol.com.

Appendix A Apparatus and Materials— Machine Exposure

A1. Sunshine Carbon Arc Lamp Exposure Apparatus-Option A and B

A1.1 Sunshine arc type artificial, weathering apparatus (see 17.2) consisting of a vertical carbon open-flame arc composed of three sets of copper clad carbons mounted at the center of a vertical shell. The arc is enclosed by Corex® D filters. A cylindrical frame between the arc and the shell supports the specimens at a distance of 47.6 cm (18.75 in.) from the center of the arc. When the machine is equipped with a new set (trim) of carbons, the extremes of distance from the upper most part of the usable test specimens on the top half of the usable test specimens on the top half of the specimen rack and likewise, the lower most part of the usable test specimens on the bottom half of the specimen rack is 53 cm (21 in.) from the center of the arc. A lamp exhaustion unit provides for flow of air around the arc and for removal of by-products of combustion of the arc. A blower unit provides a flow of air over the specimens and through the test chamber. The exact cycle is controlled by use of the cycle cams. Instrumentation provides control of irradiation, wetting, relative humidity, air temperature and black panel temperature is provided. A detailed description of the test apparatus is provided in ASTM G 152, Standard Practice for Operating Open Flame Carbon-Arc Light Apparatus for Exposure of Nonmetallic Materials.

A1.2 For Option A, four number F-80 water nozzles are positioned to provide uniform wetting vertically to the specimens located in the upper half of the specimen rack and two directed at the specimens in the lower half of the specimen rack. The center of the nozzle tip is located 11.8 cm (4.63 in.) from the specimen and directed 52 degrees from the shortest perpendicular plane to the specimen rack. The angle of spray is 80 degrees. The center two nozzles are located centrally with respect to the vertical rack 13.6 cm (5.38 in.) apart. One nozzle 10.2 cm (4 in.) above and one nozzle 10.2 cm (4 in.) below the centrally located nozzles. The nozzle pressure must be 124-172 kPa (18-25 psi) to provide 0.26-0.36 dm³ (0.46-0.64 pt/min) of water.

A1.3 Vaporizing units add moisture to the air as it passes through the conditioning chamber prior to its entry into the test chamber. Relative humidity of the air in the test chamber is determined from readings of wet and dry bulb thermometers, either indicating or recording, whose sensing portion is located in the air flow at its point of exit from the test chamber.

A1.4 Testing temperature is measured and regulated on the basis of a black-panel thermometer unit. Control of the black-panel temperature is accomplished preferably by a continuous flow of air over the specimen at a controlled temperature, but an on-off flow of room temperature air is permissible.

A1.5 Water supply, demineralized, distilled or reverse osmosis. Water transport lines must be constructed of stainless steel or other acceptable materials that will not provide contamination to the water. Provision must be made to maintain water temperature entering the test chamber at $16 \pm 15^{\circ}\text{C}$ ($60 \pm 9^{\circ}\text{F}$).

Appendix B Suggested Machine Calibration and Maintenance Schedule

Follow the manufacturer's instructions for suggested calibration and maintenance schedule.

B1. Component Replacement

B1.1 Carbons. Change daily.

B1.2 Lamp Assembly. Replace when worn or excessively pitted.

B1.3 Corex® D Filters. Replace Corex® D Filters after 2000 h of use or when pronounced discoloration or milkiness develops, whichever occurs first. Filters should be replaced on a rotating replacement schedule to provide more uniformity over long periods of exposure. A recommended rotation schedule consists of replacing one of the eight filter panels after each 250 h interval of machine operation.

B1.4 Black Panel Sensor. When bare metal is observed or surface luster can no longer be maintained (see 17.1).

B2. Cleaning

B2.1 Corex® D Filters. Wash filters each day with detergent and water.

B2.2 Black Panel Sensor. Minimum is

weekly. Use a good quality automotive polish.

B2.3 Test chamber. When discoloration or mineral deposits are observed, minimum is once per month. Use stainless steel cleaning agent that contains NO chloride, flush with deionized water or equivalent.

B2.4 Conditioning Chamber. Minimum is once per month. Drain and flush out sediment with deionized water or equivalent.

B2.5 Lamp Assembly. Brush loose carbon residue daily.

B3. Verification of Operation

B3.1 Controls. Inspect daily to ensure proper set points.

B3.2 Calibration. Minimum is once per week. Use procedures detailed in the manufacturers instructions.

B3.4 Records. Maintain weekly records of operating set point and calibrations.

Aqueous Liquid Repellency: Water/Alcohol Solution Resistance Test

Developed in 2004 by AATCC Committee RA56; reaffirmed and editorially revised 2005.

1. Purpose and Scope

1.1 This test method can be used to determine the efficacy of a protective finish that is capable of imparting a low energy surface on all types of fabrics, by evaluating the fabric's resistance to wetting by a selected series of water/alcohol solutions of different surface tensions.

2. Principle

2.1 Drops of standard test liquids, consisting of a selected series of water/alcohol solutions with varying surface tensions, are placed on the fabric surface and observed for wetting, wicking and contact angle. The aqueous repellency grade is the highest numbered test liquid which does not wet the fabric surface. (The scale ranges from zero to eight, with a rating of eight signifying the most repellent surface.)

3. Terminology

3.1 **grade**, n.—*in textile testing*, the symbol for any step of a multi-step standard reference scale for a quality characteristic.

NOTE: The grade is assigned to test specimens exhibiting a degree of the quality comparable to that step of the standard.

3.2 **aqueous repellency**, n.—*in textiles*, the characteristic of a fiber, yarn or fabric whereby it resists wetting by aqueous liquids.

4. Safety Precautions

NOTE: These safety precautions are for information purposes only. The precautions are ancillary to the testing procedures and are not intended to be all inclusive. It is the user's responsibility to use safe and proper techniques in handling materials in this test method. Manufacturers MUST be consulted for specific details such as material safety data sheets and other manufacturer's recommendations. All OSHA standards and rules must also be consulted and followed.

4.1 Good laboratory practices should be followed. Wear safety glasses and impervious gloves when handling test liquids in all laboratory areas.

4.2 The alcohol specified in this method is flammable. Keep away from heat, sparks and open flame. Use with adequate ventilation. Avoid prolonged

breathing of vapor or contact with skin. Do not take internally.

4.3 Exposure to chemicals used in this procedure must be controlled at or below levels set by governmental authorities [e.g., Occupational Safety and Health Administration's (OSHA) permissible exposure limits (PEL) as found in 29 Code of Federal Regulations (CFR) 1910.1000 of January 1, 1989]. In addition, the American Conference of Governmental Industrial Hygienists (ACGIH) Threshold Limit Values (TLVs) comprised of time weighted averages (TLV-TWA), short term exposure limits (TLV-STEL) and ceiling limits (TLV-C) are recommended as a general guide for air contaminant exposure which should be met (see 12.1).

5. Uses and Limitations

5.1 This test method is not intended to give an absolute measure of the resistance of the fabric to staining by all aqueous materials. Other factors, such as composition and viscosity of the aqueous substances, fabric construction, fiber type, dyes, other finishing agents, etc., also influence stain resistance. This test can, however, provide a rough index of aqueous stain resistance, in that generally the higher the aqueous solution repellency grade, the better resistance to staining by aqueous materials, especially liquid aqueous substances. This is particularly true when comparing various finishes for a given fabric.

6. Apparatus and Materials

6.1 Test liquids prepared and numbered according to Table IV (see 12.2).

6.2 Dropping bottles (see 12.3).

6.3 White AATCC Textile Blotting Paper (see 12.4).

6.4 Laboratory gloves (general purpose is sufficient).

7. Test Specimens

7.1 Test two specimens approximately 20 × 20 cm (8 × 8 in.) from each sample. Condition the test specimens for a minimum of 4 h at 21 ± 1°C (70 ± 2°F) and 65 ± 2% RH prior to testing.

8. Procedure

8.1 Place the test specimen flat on the white textile blotting paper on a smooth, horizontal surface.

8.1.1 When evaluating open weave of "thin" fabrics, conduct the test on at least two layers of the fabric; otherwise, the

test liquid may wet the underlying surface, not the actual test fabric, and thereby cause confusion in the reading of the results.

8.2 Wearing clean laboratory gloves, brush the pile of napped or pile fabrics lightly with your hand in the direction giving the greatest lay of the surface prior to placing the drops of the test liquid.

8.3 Beginning with the lowest-numbered test liquid (AATCC Aqueous Solution Test Grade Liquid No. 1), *carefully* place small drops [approximately 5 mm (0.19 in.) in diameter or 0.05 mL volume] on the test specimen in three locations along the filling direction. The drops should be approximately 4.0 cm (1.5 in.) apart. The dropper tip should be held at a height of approximately 0.6 cm (0.25 in.) from the fabric surface while placing drops. DO NOT TOUCH THE FABRIC WITH THE DROPPER TIP. Observe the drops for 10 ± 2 s, from approximately a 45° angle.

8.4 If no penetration or wetting of the fabric at the liquid-fabric interface and no wicking around the drops occur, place drops of the next higher-numbered test liquid at an adjacent site on the fabric and again observe for 10 ± 2 s.

8.5 Continue this procedure until one of the test liquids shows obvious wetting or wicking of the fabric under or around the drop within 10 ± 2 s.

9. Evaluation

9.1 The AATCC Aqueous Solution Repellency Grade of a fabric is the numerical value of the highest-numbered test liquid which will not wet the fabric within a period of 10 ± 2 s. A grade of zero (0) is assigned when the fabric fails the 98% water solution test liquid. Wetting of the fabric is normally evidenced by a darkening of the fabric at the liquid-fabric interface or wicking and/or loss of contact angle of the drop. On black or dark fabrics, wetting can be detected by loss of "sparkle" within the drop.

9.2 Different types of wetting may be encountered depending on the finish, fiber, construction, etc.; and the determination of the end point can be difficult on certain fabrics. Many fabrics will show complete resistance to wetting by a given test liquid (as indicated by a clear drop with a high contact angle, see Fig. 1, Example A) followed by immediate penetration by the next higher-numbered test liquid. In these instances the end point, and aqueous solution repellency grade, is

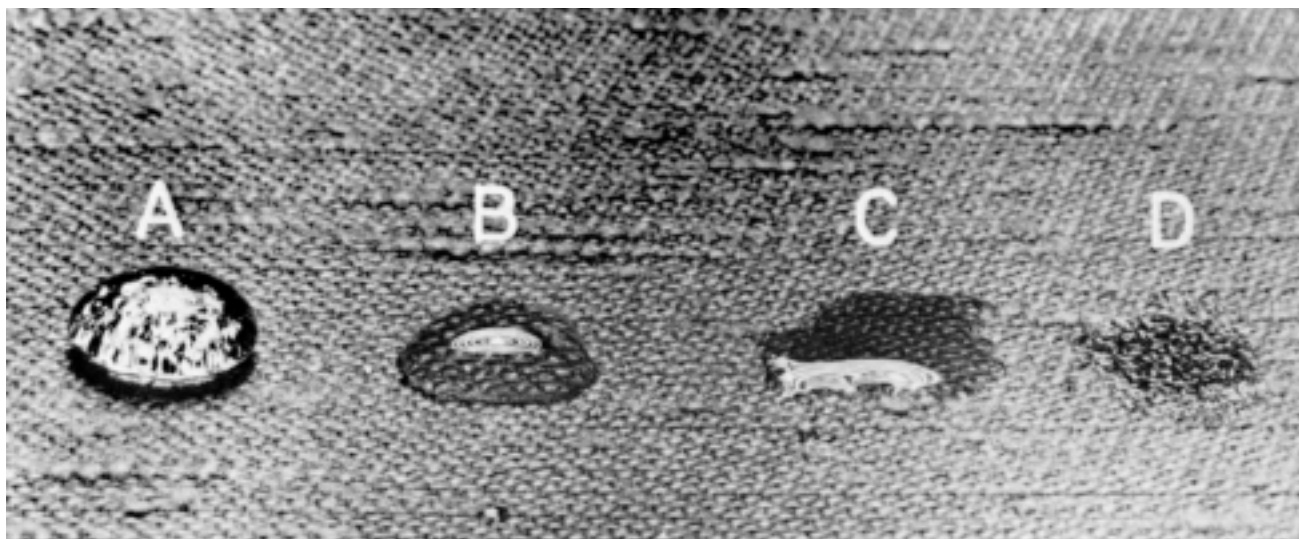

A = Passes; clear well-rounded drop
 B = Borderline pass; rounding drop with partial darkening
 C = Fails; wicking apparent and/or complete wetting
 D = Fails; complete wetting

Fig. 1—Grading example.

obvious. However, some fabrics will show progressive wetting under several test liquids as evidenced by a partial darkening of the fabric at the liquid-fabric interface (see Fig. 1, Examples B, C and D). For such fabrics, the point of failure is considered to be that test liquid which exhibits complete darkening of the interface or any wicking within 10 ± 2 s.

9.3 A **failure** occurs when two (or more) of the three drops applied from a given test liquid show complete wetting (Fig. 1[D]) or wicking with loss of contact angle (Fig. 1[C]). A **pass** occurs if two (or more) of the three drops applied show clear well rounded appearance with high contact angle (Fig. 1[A]). The grade is expressed as the integer value of the pass test liquid immediately prior to the fail test liquid. A **borderline pass** occurs if two (or more) of the three drops applied show the rounded drop with partial darkening of the test specimen (Fig. 1[B]). The grade is expressed to the nearest 0.5 value determined by subtracting one-half from the number of the borderline pass test liquid.

10. Report

10.1 The aqueous solution repellency grade should be measured on two separate specimens. If the two grades agree, report the value. When the two grades are not in agreement, a third determination should be made. Report the grade of the third determination if that value is the same as either of the first two determinations. When the third determination is

different from either of the first two, report the median value. For example, if the first two grades are 3.0 and 4.0 and the third determination is a 4.5 value, report the median value of 4.0. Report the aqueous solution repellency grade to the nearest 0.5 value (see Fig. 1 and 9.3).

11. Precision and Bias

11.1 *Summary.* Intralaboratory tests were conducted in November 2002 and January 2003 to establish the precision of this test method. Both intralab testings involved two participants in one laboratory rating two specimens of each of seven fabrics each day for three days. The grades of these intralabs use the scale from 1-10. All materials necessary for the intralabs were provided by customer fabric trials and were processed at two finish load levels. The fabrics used included nylon, polyester, cotton and polyester/cotton materials. The unit of measure was the median of the grades of the two (or three) specimens rated each day.

11.2 The components of variance as standard deviations of the aqueous solution repellency grade were calculated as shown in Table I.

Single operator	0.26
Between operator/within laboratories	0.43

11.3 *Critical differences.* For the com-

ponents of variance in 11.2, two observations should be considered significantly different at the 95% probability level if the difference equals or exceeds the critical differences shown in Table II.

11.4 *Bias.* The true value of the aqueous solution repellency grade can only be defined in terms of this test method. Within this limitation, this test method has no known bias.

No. of Observations ^b	Single Operator	Within Laboratory
1	0.50	0.79
2	0.18	0.59
3	0.15	0.48

^a The critical differences were calculated using $t = 1.950$, which is based on infinite degrees of freedom.

^b An observation is a unit of measure obtained from the median of the grades for 2 (or 3) specimens.

Fabric	Finish load level	
	Low	High
Cotton	3.5	5.5
Polyester		7.5
Cotton/Polyester	1.5	2.5
Nylon	6	8

Table IV—Standard Test Liquids

AATCC Aqueous Solution Repellency Grade Number	Composition	Surface Tensions *N
0	None (fails 98% water)	
1	98:2/Water : isopropyl alcohol (vol:vol)	59.0
2	95:5/Water : isopropyl alcohol (vol:vol)	50.0
3	90:10/Water : isopropyl alcohol (vol:vol)	42.0
4	80:20/Water : isopropyl alcohol (vol:vol)	33.0
5	70:30/Water : isopropyl alcohol (vol:vol)	27.5
6	60:40/Water : isopropyl alcohol (vol:vol)	25.4
7	50:50/Water : isopropyl alcohol (vol:vol)	24.5
8	40:60/Water : isopropyl alcohol (vol:vol)	24.0

*N = dynes/cm at 25°C

12. Notes

12.1 Available from Publications Office, ACGIH, Kemper Woods Center, 1330 Kemper Meadow Dr., Cincinnati OH 45240; tel: 513/742-2020.

12.2 Test Liquids 1-8 are available from CBM Group of N.C. Inc., 1308 N. Ellis Ave., Dunn NC 28334; tel: 910/892-8985; fax: 910/892-5701; or Textile Innovators Corp., div. of SDL Atlas, P.O. Box 8, Windsor NC 27983; tel: 252/794-9703; fax: 252/794-9704.

12.3 For convenience, it is desirable to

transfer the test liquids from stock solutions to dropping bottles; each marked with the appropriate AATCC Aqueous Solution Repellency Grade number. A typical system found useful consists of 60 mL dropping bottles with ground-in pipettes and Neoprene bulbs. Prior to use the bulbs should be soaked in heptane for several hours and then rinsed in fresh heptane to remove soluble substances. It has been found helpful to place the test liquids in sequential order in a wooden platform on the grading table. NOTE: Ratio of test liquids does affect surface tension of the liquid. Use only analytical grades of test liquids. The sur-

face tension of the liquids should be checked every month or the liquids in the dropper bottles should be replaced every month from a sealed stock solution bottle since the isopropyl alcohol concentration decrease due to evaporation.

12.4 Available from AATCC, P.O. Box 12215, Research Triangle Park NC 27709; tel: 919/ 549-8141; fax: 919/549-8933; e-mail: orders@aatcc.org.

12.5 Isopropyl alcohol is available from any chemical vendor such as Aldrich, P.O. Box 355, Milwaukee WI 53201; tel: 800/558-9160.

Gray Scale for Color Change

Adopted in 1954 by AATCC; under jurisdiction of AATCC Committee RA36; revised 1979, 1987, 2002; editorially revised 1991; editorially revised and reaffirmed 1992. Technically equivalent to ISO 105-A02.

1. Scope

1.1 This evaluation procedure describes the use of a Gray Scale for visually evaluating changes in color of textiles resulting from colorfastness tests. For instrumental assessment of change of color of a test specimen refer to AATCC Evaluation Procedure 7. A precise colorimetric specification of the differences between the reference and the 9-step Scale is given as a permanent record against which newly prepared Gray Scales, and old scales that might have changed, can be compared.

2. Principle

2.1 The result of a colorfastness test is rated by visually comparing the difference in color or the contrast between the untreated and treated specimens with the differences represented by the Scale (see 8.1). The colorfastness grade is equal to the gray scale step which is judged to have the same color or contrast difference.

3. Terminology

3.1 **color change**, *n.*—a change in color of any kind whether in lightness, hue or chroma, or any combination of these, discernible by comparing the test specimen with a corresponding untested specimen.

3.2 **colorfastness**, *n.*—the resistance of a material to change in any of its color characteristics, to transfer of its colorant(s) to adjacent materials or both, as a result of the exposure of the material to any environment that might be encountered during the processing, testing, storage or use of the material.

3.3 **Gray Scale**, *n.*—a scale consisting of pairs of standard gray chips, the pairs representing progressive differences in color or contrast corresponding to numerical colorfastness grades.

4. Description of the Scale

4.1 Colorfastness grade 5 is represented on the scale by two reference chips mounted side by side, neutral gray in color and having a Y tristimulus value of 12 ± 1 . The color difference of the pair is $0.0 + 0.2$.

4.2 Colorfastness grades 4.5 to 1, inclusive, are represented by reference chips like those used in Step 5 paired with lighter neutral gray chips of similar dimensions and gloss. The visual differences in the whole step pairs — colorfastness grades 4, 3, 2 and 1 — are in geometric steps of color difference, or contrast. The differences in the half-step colorfastness grade pairs — 4-5, 3-4, 2-3 and 1-2 — are intermediate between the whole step pairs (see 8.2, 8.3 and Fig. 1).

5. Use of the Scale

5.1 Place a piece of the original textile and its corresponding exposed test specimen side by side in the same plane and oriented in the same direction. Take special care to create a sharp junction between the two pieces of material. Place the Gray Scale along the edges of the test specimen and original textile sample with the junctions of the textile and the Gray Scale pair aligned. Place the gray mask (Y tristimulus of 53 ± 1) provided with the scale over the samples and the scale to eliminate any influence of the surrounding areas. Back the specimens, both the original and tested, with a white material having a Y tristimulus value of at least 85. If the specimens are permanently mounted on a card, it must be with a Y tristimulus value of at least 85. Any means of attachment (staples, etc.) must not be in the area viewed (see Fig. 2).

Illuminate the surfaces with a daylight simulator with illumination level at the specimen plane in the range of 1080-1340 lx (100-125 fc) (see 8.4). The light should be incident upon the surfaces at $45 \pm 5^\circ$ and the direction of viewing $90 \pm 5^\circ$ to the plane of the surfaces (see Fig. 3).

Compare the perceived visual difference between original and tested textile with the perceived differences represented by the Gray Scale. The colorfastness grade is that number of the Gray Scale pair whose contrast corresponds to the contrast between the original and tested specimens. A grade of 5 is given only when there is no perceived difference in color or contrast between the original material and tested specimen. The cleanliness and physical condition of the Gray Scale is extremely important in obtaining consistent results (see 8.5).

5.2 When a number of assessments have been made, it is very useful to compare all the pairs of original and tested specimens which have been given the same numerical grade. This gives a good indication of the consistency of the

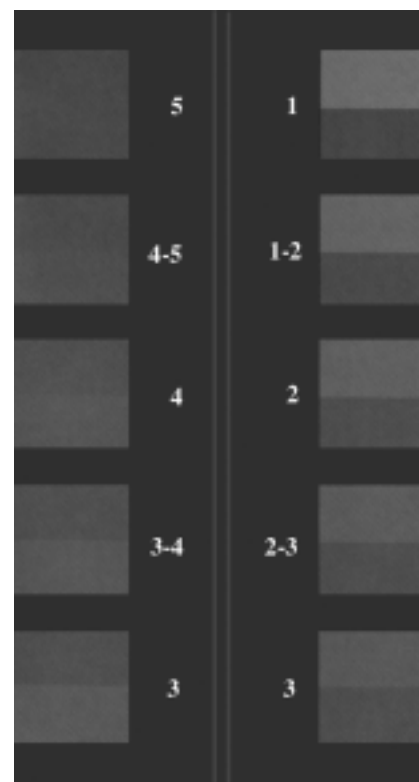

Fig. 1—Gray Scale for Color Change.

grades, since any errors become prominent. Pairs which do not appear to have the same degree of contrast as others with the same grades should be re-checked against the Gray Scale and, if necessary, the grades should be changed.

6. Describing Color Changes in Colorfastness Tests

6.1 In using the Gray Scale, the character of the change in color, whether in lightness, hue or chroma, or any combination of these, is not rated; the overall difference, or contrast, between original and tested specimens is the basis for the evaluation.

If a record of the character of the change in color of the textile in the test is needed, add appropriate qualitative terms to the numerical grade, as illustrated in Table I.

7. Colorimetric Specification of Color Differences of the Gray Scale

7.1 The color differences and tolerances between the reference gray and the nine steps of the scale are expressed as to-

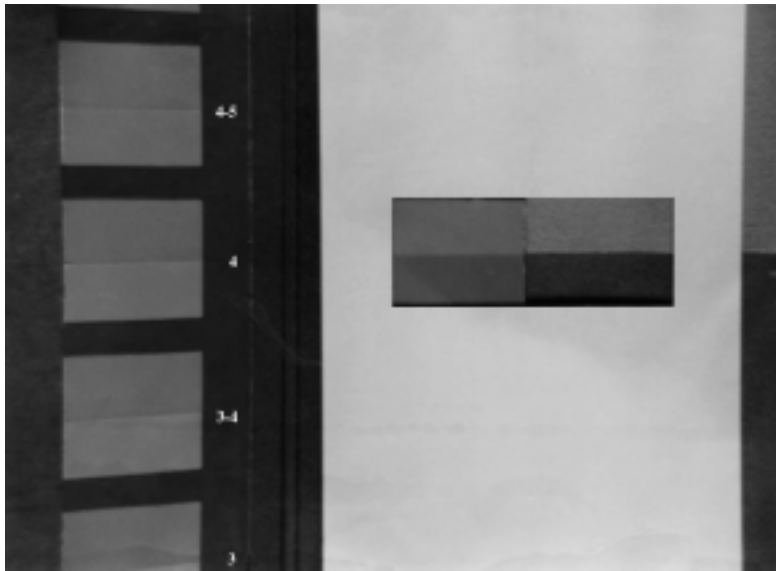

Fig. 2—Illustration of how to use scale.

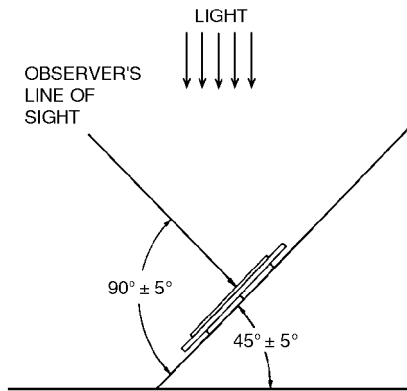

Fig. 3—Illumination and viewing angles for rating samples.

tal color difference ΔE_{CIELAB} using the CIE 1976 $L^*a^*b^*$ color difference formula:

$$\Delta E = [(\Delta L^*)^2 + (\Delta a^*)^2 + (\Delta b^*)^2]^{1/2}$$

where:

$$L^* = 116 (Y/Y_n)^{1/3} - 16$$

$$a^* = 500 [(X/X_n)^{1/3} - (Y/Y_n)^{1/3}]$$

$$b^* = 200 [(Y/Y_n)^{1/3} - (Z/Z_n)^{1/3}]$$

$(X/X_n, Y/Y_n, Z/Z_n > 0.01)$

The tristimulus values X_n, Y_n, Z_n define the color of the nominally white object-color stimulus.

7.2 Permissible tolerances for the Gray Scales used as working standards are given in the last column of Table II, Appendix A.

8. Notes

8.1 Available from AATCC, P.O. Box 12215, Research Triangle Park NC 27709; tel: 919/549-8141; fax: 919/549-8933; e-mail: orders@aatcc.org.

8.2 The colorfastness grades of the scale steps and the corresponding total color differences and tolerances, determined by the CIE 1976 $L^*a^*b^*$ (CIELAB) formula, are given in Table II, Appendix A. Sphere geometry spectrophotometric measurements of the chips shall be taken with the specular component included. A $0^\circ/45^\circ$ ($45^\circ/0^\circ$) geometry is an acceptable alternate. The colorimetric data shall be calculated using the CIE 1964 10° observer data for Illuminant D_{65} .

8.3 Provision for a colorfastness grade lower than 1 is provided for in Nomenclature for Subjective Rating Processes elsewhere in this MANUAL. Any test specimen which has a change in color or contrast decidedly greater than a grade of 1 may be rated a 0.

8.4 See AATCC Evaluation Procedure 9, Visual Assessment of Color Difference of Textiles, for notes on choice of daylight simulator and illumination level.

8.5 The Scale should be inspected frequently for fingerprints and any other marks. If the marks are considered to interfere with the rating process, then the Scale should be replaced. The Scale can also be physically damaged through handling. Again, if the physical damage to the Scale interferes with the rating process, it should be replaced. Periodically, the Scale can be measured on a spectrophotometer or colorimeter to ensure that the total color differences are within specification as shown in Table II, Appendix A. Keep the Scale in its case when it is not in use.

Table I

Grade	Contrast equal to Step	Meaning
3 lighter	to Step 3 of Gray Scale	Specimen is lighter only
3 redder	to Step 3 of Gray Scale	No significant change in lightness but change in hue in red direction has occurred
3 lighter yellow	to Step 3 of Gray Scale	Specimen is lighter and change in hue in yellow direction has occurred
3 lighter bluer, less chroma	to Step 3 of Gray Scale	Specimen is lighter and change in hue in blue direction and change in chroma has occurred
4-5 redder	to Step 4-5 of Gray Scale	No significant change in lightness, but change in hue in red direction has occurred

When space available for recording qualitative terms is restricted as on pattern cards, the following abbreviations may be used:

Bl = bluer	L = lighter
G = greener	Da = darker
R = redder	MC = more chroma
Y = yellower	LC = less chroma

Appendix A

A.1 Table II provides the color difference values in CIE 1976 $L^*a^*b^*$ (CIELAB) units for the grade pairs in each step of the Gray Scale for Color Change. This table is for instrumental measurement and confirmation that a Gray Scale is within tolerance, only. Table II is NOT to be used for assigning a Gray Scale grade based on instrumental measurement of two specimens (see AATCC Evaluation Procedure 7, Instrumental Assessment of the Change in Color of a Test Specimen).

Table II

Colorfastness Grade	Total Color Difference CIELAB Units	Tolerance for Working Standards CIELAB Units
5	0.0	+ 0.2
4-5	0.8	± 0.2
4	1.7	± 0.3
3-4	2.5	± 0.3
3	3.4	± 0.4
2-3	4.8	± 0.5
2	6.8	± 0.6
1-2	9.6	± 0.7
1	13.6	± 1.0

Gray Scale for Staining

Adopted in 1954 by AATCC; under jurisdiction of AATCC Committee RA36; revised 1979, 1981, 1996, 2002, 2005; reaffirmed 1989; editorially revised 1992. Technically equivalent to ISO 105-A03.

1. Scope

1.1 This evaluation procedure describes the use of the Gray Scale for evaluating staining of textiles resulting from colorfastness tests. A precise colorimetric specification of the differences between the reference and the 9-step Scale is given as a permanent record against which newly prepared Gray Scales, and old Scales that may have changed, can be compared.

2. Principle

2.1 The result of staining from a colorfastness test is rated by visually comparing the difference in color or the contrast between the stained and unstained specimens with the differences represented by the Scale (see 7.1). The colorfastness grade is equal to the Gray Scale step which is judged to have the same color or contrast difference.

3. Terminology

3.1 **colorant staining**, *n.*—the unintended pickup of colorant by a substrate due to (1) exposure to a colored or contaminated liquid medium, or (2) direct contact with dyed or pigmented material, from which colorant transfers by sublimation or mechanical action (as in crocking).

3.2 **colorfastness**, *n.*—the resistance of a material to change in any of its color characteristics, to transfer of its colorant(s) to adjacent materials or both, as a result of the exposure of the materials to any environment that might be encountered during the processing, testing, storage or use of the material.

3.3 **Gray Scale**, *n.*—a scale consisting of pairs of standard gray chips representing progressive differences in color or contrast corresponding to numerical colorfastness grades.

4. Description of the Scale

4.1 Staining grade 5 is represented on the Scale by two identical white reference chips mounted one above the other, having a Y tristimulus value of 85 ± 2 . The color difference of the pair is 0.0 with a tolerance of $+ 0.2$ (see 7.2).

4.2 Staining grades 4.5 to 1, inclusive, are represented by a reference white chip identical with those used for grade 5, paired with darker neutral gray chips of similar dimensions and gloss. The differences in the whole step pairs—staining grades 4, 3, 2 and 1 are in geometric steps of color difference. The differences in the half-step staining grade pairs—4-5, 3-4, 2-3 and 1-2—are intermediate between the whole step grade pairs (see 7.3, 7.4 and Fig. 1).

5. Use of the Scale

5.1 Provided with the Scale is a mask with three rectangular holes in it. One is labeled “For Evaluating Stained Multifiber,” the second “For Evaluating Crock Squares,” and the third “For Evaluating General Staining.” The cleanliness and physical condition of the Gray Scale is extremely important in obtaining consistent results (see 7.5).

5.2 How the Scale and mask are used will depend on the nature of the stained materials. The following sections are concerned with the creation of a junction, where necessary, between the stained and unstained materials.

5.2.1 Large pieces of stained material. Place the specimen of the stained material side by side with a piece of the unstained material oriented in the same direction. Take special care to create a sharp junction between the two pieces of material. Place the Gray Scale along the edges of the test specimen and unstained material with the junctions of the Gray Scale and the textiles aligned. Place the “For Evaluating General Staining” mask (Y tristimulus of 53 ± 1) provided with the Scale over the samples and the Scale to normalize the surrounding area (see Fig. 2).

5.2.2 Stained crock specimens. Place the “For Evaluating Crock Squares” mask (Y tristimulus value of 53 ± 1) provided with the Scale over the crock square with the stained area centered in the mask to normalize surrounding areas. Place the Gray Scale over the mask next to the test specimen.

5.2.3 Multifiber material. Place the specimen of the stained multifiber material and a piece of the unstained multifiber material oriented in the same direction. Take special care to create a sharp junction between the two pieces of material by trimming the stained specimen. Place the Gray Scale along the edges of the test specimen and unstained

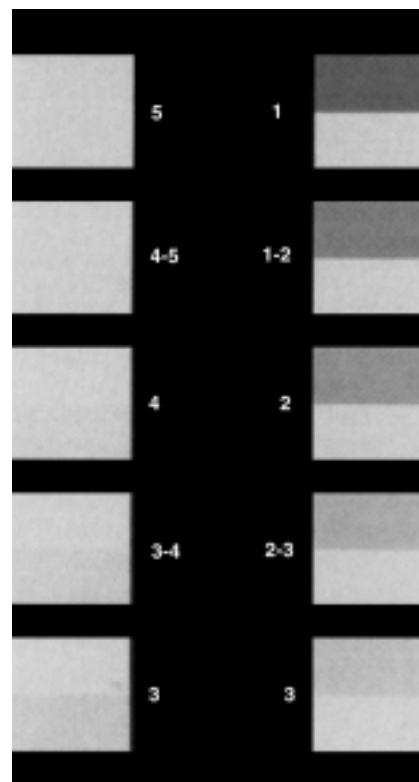

Fig. 1—Gray Scale for Staining.

material with the junctions of the Gray Scale and the textiles aligned. Place the “For Evaluating General Staining” mask (Y tristimulus of 53 ± 1) provided with the Scale over the samples and the Scale to normalize the surrounding area.

5.2.4 Irregular stains. Select appropriate sized mask and follow instructions in 5.2.1 above.

5.3 Back the stained and unstained materials with unstained, undyed material of the same kind to achieve visual opacity. Illuminate the surfaces with a daylight simulator with illumination level at the specimen plane in the range of 1080-1340 lx (100-125 fc) (see 7.6). The light should be incident upon the surfaces at approximately 45° and the direction of viewing approximately perpendicular to the plane of the surfaces (see Fig. 3). Compare the visual difference between original unstained and stained pieces with the differences represented by the Gray Scale. The grade of the specimen is that number of the Gray Scale which most closely corresponds to the contrast between the original and tested pieces. A grade of 5 is given only when there is no difference in color or contrast between

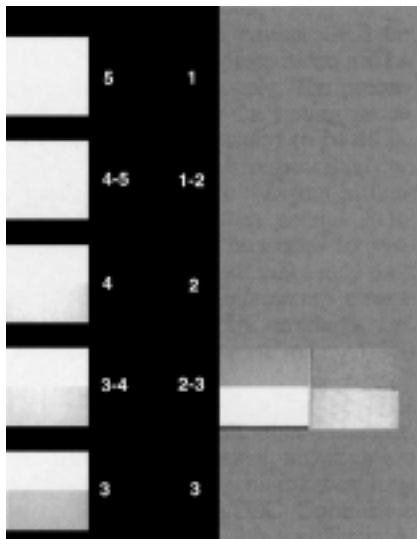

Fig. 2—Illustration on how to use scale.

the original undyed material and the tested piece.

6. Colorimetric Specification of the Color Differences of the Gray Scale

6.1 The color differences and tolerances between the reference white and the nine steps of the Scale are expressed as total color difference ΔE^*_{CIELAB} using the CIE 1976 $L^*a^*b^*$ color difference formula:

$$\Delta E^* = [(\Delta L^*)^2 + (\Delta a^*)^2 + (\Delta b^*)^2]^{1/2}$$

where:

$$L^* = 116 (Y/Y_n)^{1/3} - 16$$

$$a^* = 500 [(X/X_n)^{1/3} - (Y/Y_n)^{1/3}]$$

$$b^* = 200 [(Y/Y_n)^{1/3} - (Z/Z_n)^{1/3}]$$

$$(X/X_n, Y/Y_n, Z/Z_n > 0.01)$$

The tristimulus values X_n, Y_n, Z_n define the color of the nominally white object-

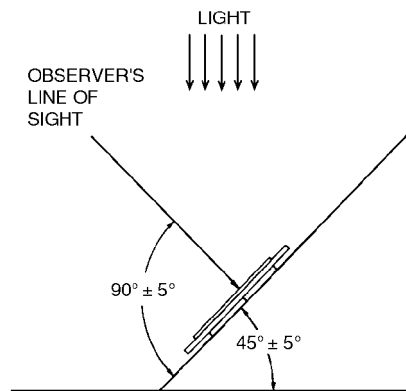

Fig. 3—Illumination and viewing angles for rating samples.

color stimulus. For D_{65} 10° observer calculation $X_n = 94.811, Y_n = 100.000$ and $Z_n = 107.304$.

6.2 Permissible tolerances for the Gray Scales used as working standards are given in the last column of Table I, Appendix A.

7. Notes

7.1 Available from AATCC, P.O. Box 12215, Research Triangle Park NC 27709; tel: 919/549-8141; Fax: 919/549-8933; e-mail: orders@aatcc.org.

7.2 AATCC guarantees that the Gray Scale for Staining meets the specifications given in this evaluation procedure.

7.3 The staining grades of the Scale steps and the corresponding color differences and tolerances, determined by the CIE 1976 $L^*a^*b^*$ (CIELAB) formula, are given in Table I, Appendix A. Sphere geometry spectrophotometric measurement of the chips shall be taken with the specular component included. A $0^\circ/45^\circ$ ($45^\circ/0^\circ$) geometry is an acceptable alternate. The colorimetric data shall be calculated using the CIE 1964 10° observer data for Illuminant D_{65} .

7.4 Provision for a colorfastness grade lower than 1 is provided for in *Nomenclature for Subjective Rating Processes* elsewhere in this MANUAL. Any test specimen which has a change in color or contrast decidedly greater than a grade of "1" may be given a grade of "0."

7.5 The Scale should be inspected frequently for fingerprints and any other marks. If the marks are considered to interfere with the rating process, then the Scale should be replaced. The Scale must be measured quarterly on a spectrophotometer or colorimeter to ensure that the total color differences are as shown in Table I, Appendix A. Keep the Scale in its case when it is not in use.

7.6 See AATCC Evaluation Procedure 9, Visual Assessment of Color Difference of Textiles, for notes on choice of daylight simulator and illumination level.

Appendix A

A.1 Table I provides the color difference values in CIE 1976 $L^*a^*b^*$ (CIELAB) units for the grade pairs in each step of the Gray Scale for Staining. This table is for instrumental measurement and confirmation that a Gray Scale is within tolerance, only. Table I is NOT to be used for assigning a Gray Scale based on instrumental measurement of two specimens.

Table I

Staining Grade	Total Color Difference CIELAB Units	Tolerance for Working Standards CIELAB Units
5	0	+ 0.2
4-5	2.2	± 0.3
4	4.3	± 0.3
3-4	6.0	± 0.4
3	8.5	± 0.5
2-3	12.0	± 0.7
2	16.9	± 1.0
1-2	24.0	± 1.5
1	34.1	± 2.0

Standard Depth Scales for Depth Determination

Developed in 1987 by AATCC Committee RA36; editorially revised and reaffirmed 1989, 1999; reaffirmed 1994; revised 2002.

1. Scope

1.1 This evaluation procedure describes the use of the standard depth scales for the determination of the dye concentration required to produce dyeings of visually equal depth for the purpose of colorfastness evaluations. Colorants may have different tinctorial strengths whereby equal concentration dyeings of them may differ markedly in the resulting color depth and colorfastness properties. Using concentrations of colorants which will give visually equal depths will provide a more comparable evaluation.

2. Principle

2.1 Dyeings at a given concentration of dye are compared visually to the standard depth scales following the guidelines in AATCC Evaluation Procedure 9, Visual Assessment of Color Difference of Textiles. If the perceived depths are not equal, the dye concentration of the test specimen is adjusted until it is judged to be visually equal in depth to a specimen on the standard depth scales.

2.2 The standard depth scales consist of six sets of 12-18 fabric dyeings of different hue and chroma and one set specifically for navy and black shades. All of the dyeings in any set are considered to be of visually equal depth.

3. Terminology

3.1 **colorant**, n.—a material which is applied to a substrate for the express purpose of changing the transmittance or reflectance of visible light.

NOTE: Dyes, pigments, tints and optical brighteners are examples of colorants; soils are not colorants.

3.2 **depth**, n.—departure of a colored object from white and frequently associated with either concentration or efficiency of a colorant.

3.3 **hue**, n.—the attribute of color perception by means of which an object is judged to be red, orange, yellow, green, blue, violet or combination of these.

3.4 **standard depth scale**, n.—*in color measurement*, a series of dyed samples of different hue and chroma that have been accepted to have the same depth.

3.5 **tinctorial strength**, n.—the effectiveness of a given mass of dye in coloring a given mass of material.

4. Description of the Scales

4.1 The primary range of 18 dyeings considered as the standard depth is designated as “standard depths 1/1.” Double depths (designated as standard depth 2/1) and fractional depths (designated as standard depths 1/3, 1/6, 1/12 and 1/25) provide supplementary indices (see 8.1).

4.2 The scales shall be equivalent to that established by the International Organization for Standardization (ISO) (see 8.2).

5. Use of the Scales

5.1 The dyeing of the standard scale that is closest in color to the test specimen is selected. The test specimen is compared to the appropriate depth scale. Illuminate the surfaces with a daylight simulator with illumination level at the specimen plane in the range of 1080-1340 lx (100-125 fc) (see 8.3). The test specimen is placed adjacent to the standard depth dyeing, and visually compared to it as described in AATCC Evaluation Procedure 9, estimating the approximate relative strength in relation to the scale. If the colors of the depth

scale sample and that of the test specimen do not match, approximate the strength by visually interpolating between the two depth scales closest in color to the test specimen. If the test specimen is assessed to be unequal in depth to the scale, adjust the concentration of the colorant in the test specimen until the relative depth of the test specimen is considered to be equal to that of one of the six standard depths (see 8.4).

6. Report

6.1 Report the test specimen that was judged equal to the depth of a scale as being equal to that scale; e.g., equal to 1/3 standard depth.

7. Precision and Bias

7.1 No statement is made regarding precision and bias of this evaluation procedure since the result merely states whether there is conformity to the criteria for success specified in the procedure.

8. Notes and References

8.1 Available from AATCC, P.O. Box 12215, Research Triangle Park NC 27709; tel: 919/549-8141; fax: 919/549-8933; e-mail: orders@aatcc.org.

8.2 ISO 105-A01: General principles of testing: Tests for colour fastness.

8.3 See AATCC Evaluation Procedure 9, Visual Assessment of Color Difference of Textiles, for notes on choice of daylight simulator and illumination levels.

8.4 Due to dyeing characteristics of individual dyes, proportioning the concentration of a dyeing at one standard depth level to produce a different depth level may not give the precisely required level; e.g., if a 1.0% dyeing produces a 1/1 standard depth, 2.0% does not necessarily produce a 2/1 standard depth.

8.5 Kuehni, Rolf G., “Standard Depth and Its Determination,” *Textile Chemist and Colorist*, Vol. 10, No. 4, pp22-25 (1978).

Fabric Hand: Guidelines for the Subjective Evaluation of

Developed in 1990 by AATCC Committee RA89; reaffirmed 1991, 1992; revised 1996 (with title change); editorially revised 1997; editorially revised and reaffirmed 2001.

1. Purpose and Scope

1.1 This evaluation procedure describes guidelines for the presentation of fabrics for the evaluation of hand. Its purpose is to standardize the conditions under which a fabric is evaluated for one or more of the constituent elements of hand (for references on constituent elements of hand see Appendix A).

1.2 These guidelines may be used in the following circumstances:

1.2.1 When different people at different times wish to follow the same protocol for examining fabrics.

1.2.2 In training evaluators to detect and distinguish among different constituent elements or components of hand.

1.2.3 When an individual wishes to duplicate the conditions under which a fabric has been previously evaluated.

1.2.4 With a panel of individuals evaluating the same fabric(s).

2. Principle

2.1 An evaluator is presented a specimen in a prescribed manner and is asked to handle the specimen in a prescribed sequence.

3. Terminology

3.1 **hand**, *n.*—the tactile sensations or impressions which arise when fabrics are touched, squeezed, rubbed or otherwise handled.

3.2 **constituent elements of hand**, *n.*—those components, qualities, attributes, dimensions, properties or impressions which make the sensation of touching one fabric different from that of touching another.

NOTE: The various terms comprising elements of hand can be categorized by physical attributes of compression, bending, shearing and surface (see Appendix A).

4. Uses and Limitations

4.1 Effective use of these guidelines is limited by the ability of the evaluator to describe the sensations being felt. Care should be taken to determine if any evaluator exhibits impairment in touch and to determine if any variation between evaluators exists.

4.2 The validity of the data collected will be dependent on prior agreement re-

garding which constituent elements of hand are to be evaluated and mutual acceptance of a scale for evaluation.

5. Specimens

5.1 Test Specimens.

5.1.1 Take large enough test specimens from each sample to allow an evaluator to hold the specimen in both hands. In general, cut all specimens to greater than 200 mm (8 in.) and less than 900 mm (35.4 in.) in either length or width direction. All specimens are to be cut to the same size and shape, even if ratings are done at different times/dates.

5.1.2 Identify the length and width direction of each specimen to provide a means to assess differences that may exist.

5.1.3 Avoid using a specimen more than one time for evaluation because stretching and crushing may change the fabric hand.

5.1.4 The number of specimens of each sample used is to be consistent with accepted statistical analysis and with the number of evaluators.

5.2 Specimen Marking.

5.2.1 Prior to conditioning and evaluation, specimens are to be prepared and marked by someone other than the evaluator.

5.2.2 Mark specimens to denote sample and specimen identification, the surface of the specimen to be evaluated and the length direction of the fabric (see 5.1.2). Use a pen or pencil, not attached labels, to mark the specimens with identification, directional and surface information.

5.2.3 Condition specimens from the dry side for a minimum of 4 h at $21 \pm 1^\circ\text{C}$ ($70 \pm 2^\circ\text{F}$) and $65 \pm 2\%$ RH prior to evaluation. Report if other conditions are used (see 9.6).

6. Evaluator Preparation

6.1 Evaluators are to wash their hands 0.5 h prior to the evaluation of specimens using the same washing procedure and soap, preferably a hand soap that does not contain moisturizers.

6.2 Evaluators are to dry their hands with the same toweling; i.e., all use cotton fabric towels or all use paper towels.

6.3 Evaluators are to avoid activities involving extreme exercise and should not expose hands to temperature changes or moisture after washing hands prior to specimen evaluation.

7. Procedure

7.1 Evaluation Set-up.

7.1.1 The evaluator is to be relaxed and comfortable in a room free of distractions. The evaluation may be performed seated or standing.

7.1.2 The evaluator is to be assisted by a facilitator who is to provide instructions about the specific elements of hand to be evaluated, the rating scale to be used, the number of samples and specimens to be rated or compared, the order of presentation, the expected duration of the rating session, and other pertinent information regarding the evaluation protocol.

7.1.3 Evaluators may communicate evaluation ratings, rankings and other tactile responses verbally to the facilitator or to a recording device. They may record hand sensations on a rating form.

7.1.4 The evaluator may or may not view specimens during a judging session. Blocking the view of specimens is generally preferred (see 11.1). This may be accomplished by handling the specimens behind a screen or drape, closing the eyes and/or using a blindfold.

7.2 Handling Sequence.

7.2.1 The facilitator is to place a specimen on a smooth, nonmetallic surface. The specimen is to be placed with the surface to be evaluated uppermost and correctly aligned as indicated by the markings on the specimen.

7.2.2 If the thermal element of hand (warm/cool) is to be evaluated, the evaluator is to make this assessment first with the initial contact of the finger tips to the fabric surface.

7.2.3 While still on a flat surface, the specimen is to be held down with one hand and stroked or touched with the other hand (see 11.2).

7.2.4 The evaluator is to then touch the specimen by lightly pressing it with the fingers and palm of the hand.

7.2.5 The evaluator is then to pick up the specimen and rub it between the thumb and fingertips.

7.2.6 Next, the evaluator is to squeeze the specimen gently between the thumb, fingers and palm by making a fist.

7.2.7 If the ease of stretch is to be judged, the specimen is to be held so there is at least 90 mm (3.5 in.) and no more than 250 mm (10 in.) of fabric between the hands. With elbows close to the body, hands are to be pulled apart noting the ease of extending the specimen. The specimen is to be stressed in the lengthwise, widthwise and diagonal (bias) directions.

7.2.8 If recovery from squeezing (resiliency) is to be judged, the evaluator must look at the specimen. The specimen is to

be clenched tightly in a fist and then released quickly; i.e., in less than 5 s. Such evaluation is to be made after all other handling procedures have been completed.

7.2.9 Repeat steps 7.2.1-7.2.8 for each specimen.

8. Evaluation

8.1 Specimens can be compared in pairs or sets and judged for the direction and magnitude of the differences in the constituent elements of hand to be assessed. One of the following techniques may be used:

8.1.1 Establish a fabric standard and rate each specimen against the reference. Using agreed upon terminology (see Appendices A and B), describe the specimen as (smoother) than the reference specimen or not as (smooth) as the reference specimen. Several specimens can be rated one at a time against the standard.

8.1.2 Establish two extremes for a property of interest described by selected hand terminology and assign arbitrary numerical values to the extremes. For example, the descriptor (limp) can be selected and arbitrarily assigned a value of 1 while the other extreme descriptor (stiff) could be assigned the value of 5. Specimens to be evaluated could then be assigned values within the established numerical scale according to the differences felt.

8.1.3 Specimens may be ranked by comparative assessments such as “most” (rough), “least” (rough) or “moderately” (rough). Ranking specimens may be difficult with increasing numbers of specimens.

8.1.4 Perception scales for the description of change in a constituent element of hand when comparing an original sample specimen against processed, treated, or other finished specimens can be developed. For example, perception scales using numerical values assigned to judgment descriptions such as 1 = no difference perceived; 2 = slight difference perceived; 3 = moderate difference perceived; 4 = extreme difference detected. Numerical values and perception descriptions may be expanded.

8.2 The evaluation should be repeated by the same individual within 1-5 days.

8.2.1 If the individual fails to rate specimens at the same points on the scale or rank them in the same order on the second day; i.e., fails to obtain consistent results on a repeat evaluation, appropriate statistical analysis shall be used as a means to determine the agreement or non-agreement of the two sets of data.

9. Report

9.1 The number of samples and specimens evaluated by each individual.

9.2 The elements of hand evaluated.

9.3 The visual blocking procedure used.

9.4 The order of presentation if different than listed in Section 7.

9.5 The evaluation scale, ranking or other assessment procedure used.

9.6 The conditions under which specimens were rated.

9.7 The numerical or assessment values.

10. Precision and Bias

10.1 *Precision.* Precision of the techniques for subjective evaluation of hand described by this guideline have not been determined. There are no predetermined rating scales for assigning numeric values to constituent elements of hand that evaluators may apply in making material comparisons to facilitate derivation of components of variance needed for precision calculations. Consequently, the user must resort to other statistics than analysis of variance in assessing the utility of the methodology for comparative purposes.

10.1.1 Results from the subjective evaluation of hand usually are in the form of arbitrary rankings, weighted descriptors, or other arbitrary, discrete, discontinuous rating scales agreed upon by those making a comparison. Non-parametric analysis techniques, based usually on the chi-square or “t” statistics for determining statistical significance and probability levels of ranking orders, are suggested for data of this type. With this kind of analysis, significance between ratings is determined, but there can be no determination of magnitude associated with variability measurement.

10.2 *Bias.* Within the guideline techniques, bias, if any, cannot be determined, since there are no known procedures for determining the true values for the constituent elements of hand.

11. Notes

11.1 Visual impressions of a specimen can cause biased tactile judgments. For example, shiny fabrics are not always exclusively slick or smooth; looped, bulky fabrics are not exclusively soft. Color preferences can also influence hand judgments.

11.2 Use of left or right hand, associated with an evaluator’s dominant hand, may cause biased tactile judgments. Users may wish to specify evaluators use either their dominant hand, or opposite to dominant hand, for touching and stroking the specimens during the evaluation process.

APPENDIX A

A1. Constituent Elements of Hand: Terminology Categorized by Physical Attribute*

PHYSICAL ATTRIBUTE			
Compression	Bending	Shearing	Surface
hard	stiff	supple	coarse
thin	pliable	clinging	rough
thick	supple	tight	slippery

PHYSICAL ATTRIBUTE

Compression	Bending	Shearing	Surface
springy	crisp	loose	harsh
fullness	limp	firm	smooth
bulky	papery	pliable	fuzzy
firm	lively	elastic	soft
soft	springy	stretchy	scratchy
lively	boardy		slick
lofty			waxy
resilient			nappy
			oily
			raspy
			warm
			cool

*Appendix A is intended as a reference listing of hand descriptors and should not be considered an exhaustive compilation of terms.

NOTE: Some terms can be attributed to more than one physical property category; i.e., the term “soft” can be considered as a compression or as a surface attribute.

APPENDIX B

B1. References Concerning Specific Constituent Elements of Hand

B1.1 AATCC, “*Bibliography on Fabric Hand.*” Compiled by AATCC Committee RA89, Hand Evaluation Test Methods, August 1995.

B1.2 ASTM, D 123, Terminology Relating to Textiles, Annex 3, Terms Relating to the Hand of Fabrics, *Annual Book of ASTM Standards*, Vol. 07.01, p92, 1986; ASTM, 100 Barr Harbor Dr., W. Conshohocken PA 19428-2959; tel: 610/832-9500; fax: 610/832-9555.

B1.3 *ASTM Manual on Sensory Testing Methods*, Special Technical Publication 434, ASTM, 1968.

B1.4 Brand, R. H., Measurement of Fabric Aesthetics, Analysis of Aesthetic Components, *Textile Research Journal*, Vol. 34, pp 791-804, 1964.

B1.5 Civile, G. V., and Dus, C. A., Development of Terminology to Describe the Hand/Feel Properties of Paper and Fabrics, *Journal of Sensory Studies*, Vol. 5, pp 19-32, 1990.

B1.6 Kawabata, Sueo, *The Standardization and Analysis of Hand Evaluation, 2nd Edition*, The Textile Machinery Society of Japan, 1980.

B1.7 Kim, C. J. and Vaughn, E. A., Physical Properties Associated with Fabric Hand, *AATCC Book of Papers*, pp 78-95, 1995.

B1.8 Wiczynski, M. E., Psychometric Properties of the Hand of Polyester/Cotton Blend Fabrics, Unpublished doctoral dissertation, University of North Carolina at Greensboro, 1988.

B1.9 Winakor, G., Kim, C. J. and Wolins, L., Fabric Hand: Tactile Sensory Assessment, *Textile Research Journal*, Vol. 50, pp 601-610, 1980.

Instrumental Color Measurement

Developed in 1995 by AATCC Committee RA36; reaffirmed 1996, 1997, 2003; reaffirmed and editorially revised 1998. Technically equivalent to ISO 105-J01.

1. General Description of Instrumental Color Measurement

1.1 Purpose

1.1.1 This evaluation procedure is a reference document to support the proper measurement of the color (or colored appearance) of specimens by instrumental means as required in many of the current AATCC test methods. The document contains three major subsections covering *reflectance measurement*, *transmittance measurement* and *related calculations*. In addition, an appendix is supplied which details specific techniques and specimen handling procedures.

1.2 Terminology

1.2.1 **area-of-view**, n.—*of color measuring instrument*, the dimensions of the surface area that a color measuring instrument is capable of covering in a single color measurement.

1.2.2 **color measuring instrument**, n.—any device, such as a colorimeter or spectrophotometer, used to measure the relative amounts of energy reflected from (or transmitted through) a specimen in the visible region of the energy spectrum (comprising the wavelengths from 360-780 nm, and including as a minimum the region from 400-700 nm).

1.2.3 **color measurement**, n.—a numerical representation of the color of an object obtained by use of a color measuring instrument. A single measurement may represent an average of multiple readings of a specimen.

1.2.4 **fluorescence**, n.—a phenomenon in which radiant flux of certain wavelengths is absorbed and re-emitted non-thermally at other, usually longer, wavelengths.

1.2.5 **geometry**, n.—*of a color measuring instrument*, one of the following terms (diffuse/0, 0/diffuse, 0/45 or 45/0) which describe the angle or manner in which a color measuring instrument:

(1) illuminates the specimen (diffuse, 0, 45).

(2) views the resulting reflected light (0 [0°-10°], diffuse, 45, 0).

Diffuse/0 and 0/diffuse geometry instruments contain a sphere used to diffuse the light illuminating [or reflected from] the specimen, while 0/45 and 45/0 geometry instruments generally use mirrors or fiber optics to direct the illumination [or view-

ing] at a 45 angle to the specimen.

NOTE: Instruments of different geometries may produce different colorimetric results on most textile materials.

1.2.6 **reflectance**, n.—the ratio of the reflected radiant or luminous energy (light) to the incident energy in the given conditions.

1.2.7 **reflectance factor**, n.—the ratio of the light reflected from the specimen to the light reflected from the perfect reflecting diffuser under the same geometric and spectral conditions of measurement.

1.2.8 **specular reflection**, n.—the reflection without diffusion, in accordance with the laws of optical reflection, as in a mirror.

1.2.9 **standardization**, n.—*of color measuring instrument*, the act of measuring one or more standard materials with a color measuring instrument for the purpose of calculating a set of correction factors to be applied to all subsequent measurements.

1.2.10 **transmittance**, n.—the ratio of transmitted light to incident light under specified geometric and spectral conditions.

NOTE: Regular transmittance (of transparent materials) is the ratio of undiffused transmitted light to incident light.

1.2.11 **transmittance factor**, n.—the ratio of the light transmitted by a specimen and evaluated by a receiver to the light passing through the same optical system and evaluated by the receiver when the specimen is removed from the system.

1.2.12 **verification standard**, n.—*in color measurement*, any stable material which is used for the purpose of confirming (or verifying) the validity of an instrument standardization. Color measurements, which are made immediately following a standardization, are compared to original measurements of the standard to detect improper standardization.

1.3 Safety Precautions

1.3.1 Normal safe laboratory practices should be observed during sample preparation and color measurement procedures. The operation of color measuring instruments should be done in accordance with specific manufacturer's instructions and precautions concerning operation and maintenance procedures.

1.4 General Guidelines

1.4.1 In general, instrumental color measurement procedures are dictated by the type of specimen to be measured and the instrument with which it will be measured. Many types of color measuring instruments are available, differing in such

features as area-of-view, illumination method and geometry. The user is cautioned that conflicting results may be obtained by comparing data acquired on instruments of different designs.

1.5 Procedure

1.5.1 Operators who utilize Evaluation Procedure 6 as a reference for color measurement should generally conduct such measurements as follows:

1.5.2 Refer to the appropriate section (Reflectance or Transmittance) for specimen to be measured.

1.5.3 Standardize instrument according to section titled *Standardization*. Maintain a record of the procedure and of the results for any verification standards measured.

1.5.4 Obtain and prepare specimen, noting any special sampling and/or conditioning procedures that may be required (see Appendix A.1.2).

1.5.5 Present specimen to color measuring instrument, again following any special techniques required for the type of material being measured (see Appendix A).

1.5.6 Measure the color of the specimen, obtaining the appropriate spectral reflectance or transmittance factors or colorimetric values.

1.5.7 Perform any appropriate numerical calculations as specified in Section 4 or as is required by the specific test method.

2. Measurement of Color by Reflectance Methods

2.1 Principle

2.1.1 Materials of an opaque or nearly opaque nature (but not translucent) are measured by reflectance methods to obtain a numerical representation of the color of the specimen. Proper equipment setup, standardization of the color measuring instrument, and proper presentation of the test specimens to the instrument are required to achieve consistent, reliable, and meaningful reflectance measurement results. In addition, calculation of the colorimetric values required for evaluating the results must be performed in the prescribed manner.

2.2 Uses and Limitations

2.2.1 This section is restricted to the measurement of the color of opaque and nearly opaque specimens by reflectance spectrophotometers or reflectance colorimeters. The use of special procedures and/or aids to the presentation of specimens is covered in the appendix.

2.3 Apparatus and Materials

2.3.1 Reflectance color measuring instrumentation illuminates a specimen and measures the amount of light which is re-

flected from the surface of the specimen. Illumination is normally done in a polychromatic manner (white light), however monochromatic mode is acceptable for nonfluorescent specimens. Reflectance color measuring instruments may be broadly divided between two groups: Spectrophotometers and Colorimeters.

2.3.2 Spectrophotometers (typically diffuse/0°, using polychromatic illumination) separate and measure the spectrum of light reflected from the specimen, relative to a reference, white at regular intervals (wavelength intervals of 5 nm, 10 nm, and 20 nm are most common). This data may be used to calculate the needed tristimulus values (X, Y, Z) for any given illuminant and observer. Some spectrophotometers (typically 0/diffuse) illuminate the sample with monochromatic light, and measure the amount of light reflected from the surface as the sample is illuminated at regular wavelength intervals.

2.3.3 Colorimeters measure the tristimulus values (X, Y, Z) directly through broadband filters which are designed to produce colorimetric values for one illuminant and observer (typically C/2°). Measurement of reflectance factors at specific wavelengths is not possible with a colorimeter.

2.3.4 Within these two categories, the instruments are further defined by their geometry. Two types of geometries are prevalent: Sphere (also referred to as diffuse/0° [d/0°] or 0/diffuse [0°/d]) and 45/0 or 0/45. The first term in each geometry type refers to the method (or angle) by which the sample is illuminated (ex: 45 degrees in a 45/0 instrument). The second term refers to the angle at which the instrument views the illuminated specimen (ex: 0 degrees in a 45/0 instrument).

2.3.5 Diffuse/0 (sphere) instruments illuminate the specimen indirectly when the specimen is placed against a port opening into a diffusely illuminated sphere, and view the specimen at an angle between 0 and 10 degrees from the perpendicular. This arrangement is designed to capture all light reflected from the specimen. Some sphere instruments with a viewing angle greater than 0 include a *specular port* which allows for the inclusion or exclusion of the *specular reflectance*.

2.3.6 0/diffuse (sphere) instruments are similar, but the path of illumination and viewing are reversed. This method illuminates the sample at an angle between 0 and 10 degrees, and measures the amount of light reflected from the surface into the sphere.

2.3.7 Instruments with 45/0 or (0/45) geometry illuminate the specimen at the first angle and view the specimen at the second. These two geometries can be either circumferential (viewing or illuminating at 45 to the specimen in a complete circle) or directional. For most

textile samples, either 45/0 or 0/45 yield equivalent results.

2.3.8 All color measuring instruments require a white calibrated standard with which to standardize the instrument. The colorimetric values for this calibration standard are stored in the instrument or the software and require only that a specific standard be used to standardize the instrument. The correct white standard is usually identified with a serial number.

2.4 Standardization

2.4.1 Proper standardization of any color measuring instrument is absolutely necessary to achieve uniform, accurate results. While different types of instruments require varying methods of standardization, there are common principles which must be observed.

2.4.2 In general, an instrument standardization involves measuring a clean white surface of known reflectance factors (referenced to a perfect reflecting diffuser) and calculating (through software built into the instrument or computer program) a series of correction factors which will be applied to all subsequent measurements. Some instruments also require a black tile (or light trap), and possibly a gray tile. Each of these materials must be maintained in its original clean, unscratched condition. Refer to manufacturer's recommendations for cleaning instructions.

2.4.3 The frequency with which this standardization must be performed depends on many factors including the type of instrument, the environmental conditions in which the instrument operates, and the required accuracy of the results. For most applications, an interval of 2-4 h is typical.

2.4.4 Once the standardization step has been performed, it is important to verify the success of the procedure by measuring some colored materials (**verification standards**) and comparing the resulting colorimetric values to the original values for these materials. If the measured values do not fall within an acceptable variation from their original values, the standardization is not considered valid. The number of **verification standards** and the acceptability limits depend on user requirements, but are typically 1-3 standards and an acceptance limit of 0.20 ΔE_{CMC} (2:1) ($D_{65}/10^\circ$) units.

2.5 Sampling

2.5.1 All measurements taken on color measuring instrumentation involve "**sampling**." The area-of-view of the instrument, the number of presentations averaged to produce a single measurement, the difficulty of presenting the specimen to the instrument, and the accuracy with which the sample represents the object of concern (garment, roll, dye lot, etc.) all play important parts in achieving meaningful and reproducible results. Refer to ASTM Test Method **E 1345** (see

7.1) and SAE Test Method **J1545** (see 7.3) for techniques in establishing sampling procedures.

2.6 Specimen Preparation

2.6.1 The ideal specimen to measure is a rigid, non-textured, inert, opaque specimen of uniform color. Such ideal specimens do not exist in textiles, so it becomes necessary to employ techniques and practices when measuring most textile materials which eliminate or reduce the effect any objectionable characteristics have on the instrumental color measurement. Specific procedures and techniques for handling specimens which meet the following characteristics are presented in the Appendix.

2.6.2 *Fluorescence* of the specimen (from dyes or fluorescent whitening agents [FWAs]) will influence the results depending on the amount of fluorescing material present and the amount and quality of ultraviolet and visible energy in the instrument light source. Results may be particularly hard to duplicate between instruments. Example materials are white or lightly colored materials treated with FWAs.

2.6.3 *Moisture Content* of textile materials can affect their color and appearance characteristics. The amount of conditioning time necessary to achieve a stable moisture state varies with fiber, fabric construction, dyes and surrounding conditions. Examples of materials which are typically affected by moisture content are cotton and rayon fabrics.

2.6.4 *Non-Rigid* specimens tend to protrude (or "pillow") into the viewing port of instruments which contact the specimen at the measurement port. The amount of intrusion may vary depending on number of layers, softness of material and the backing pressure applied to mount the specimen. Variations in the amount of intrusion will result in significant deviations in the resulting color measurement which are both unpredictable and non-reproducible. Examples of these materials are fiber, yarn, knits and layers of lightweight fabric.

2.6.5 *Non-Opaque* specimens allow some light to pass through the material during measurement. Most textile materials, by nature of their structure, fit this category. During measurement, any light which passes through the material to reach the backing plate (or escape from the instrument) will yield false and unpredictable results. Examples of these materials are knits, lightweight materials, and fiber.

2.6.6 *Sensitivity* of the specimen to light (photochromism) and/or heat (thermochromism) will result in unpredictable and nonreproducible results, depending on the degree of sensitivity and the amount of time the specimen is exposed to objectionable conditions.

2.6.7 *Size* of the specimen is important

in obtaining a representative measurement by the instrument. When the specimen is too small for normal measurement, special techniques may be required to achieve a proper color measurement.

2.6.8 *Surface Texture* of the specimen (including pile lay, twill, gloss, and luster) will affect the results of the color measurement. The color measurement of specimens with such physical characteristics will be affected in different ways depending on the geometry of the instrument. Results between instruments may be non-reproducible. Examples of these specimens are carpet, corduroy and wound yarn.

2.6.9 *Variation in Color* (non-uniformity) within the specimen, as related to the area-of-view of the instrument can cause inaccurate and non-reproducible results. Examples are denim and heathers.

3. Measurement of Color by Transmittance Methods

3.1 Principle

3.1.1 Materials of a transparent nature are measured by transmittance methods to obtain a numerical representation of their color and/or strength. The most common application is the measurement of solutions of dyes in clear solvents contained in a glass cuvette or flow cell for the purposes of determining colorant identity, relative strength or color difference.

3.2 Uses and Limitations

3.2.1 This method is generally suitable for the measurement of true solutions which are transparent and void of particulate matter. Although translucent or turbid liquids are sometimes measured by transmittance methods, such methods are beyond the scope of this evaluation procedure.

3.3 Apparatus, Reagents, and Materials

3.3.1 Transmittance instruments may be dedicated instruments (capable only of measuring transmittance specimens), or may be combined with a sphere for an instrument capable of performing both reflectance and transmittance measurements. Most transmittance instruments are spectrophotometers, although a few are colorimeters.

3.3.2 Transmittance cells (used to hold the solution during measurement) are typically made of glass or quartz, and are designed for specific pathlengths (normally 10 mm) suitable for measurement of most textile related solutions (usually requiring some dilution steps to be taken before measurement). Flow-through cells, which allow the solution to be pumped or fed through them, are more efficient for high volume applications and usually result in better reproducibility of results.

3.3.3 When using volumetric procedures,

volumetric glassware (pipettes and flasks) is **absolutely required** for proper preparation of specimens, and only glassware which is rated at *class A* should be used.

3.3.4 Balances which are capable of accurate results within 0.1% of the quantity being weighed must be used when weighing specimens used to prepare the solution for measurement.

3.4 Standardization

3.4.1 Before measuring specimen(s), the instrument must be standardized according to the manufacturer's directions. Normally this requires measuring a clear solution of the solvent used for dissolution (usually distilled water) in a clean transmittance cell to produce a 100% reference line. Some instruments require the measurement of a "blocked beam" to set a 0% reference. This procedure produces a set of correction factors which are applied to all subsequent measurements. The use of one or more colored filters as a **verification standard** to check both photometric and wavelength accuracy is recommended.

3.5 Sampling

3.5.1 Sampling procedures for transmission methods depend on the nature of the material and the type of specimen collected. Powder and paste specimens should be taken from enough locations to ensure a reproducible sample within the population being sampled and thoroughly mixed prior to proceeding with weighing and dissolving.

3.6 Specimen Preparation

3.6.1 Specimens must be prepared by prescribed laboratory procedures using analytical balances and volumetric glassware. Solutions should be prepared at a concentration at which the percent transmittance of the solution in the transmittance cell is between 10% and 50% at the wavelength of maximum absorbance (see 7.4). Each specimen must be in true solution, not in suspension, dispersion or association. When preparing specimens where solubility is unknown, it is necessary to let the prepared solution stand for a period of time to observe any settling of contents. If such settling is observed, a true solution does not exist and other solvent systems are required. All specimens should be allowed to reach room temperature prior to presenting the specimen to the instrument.

4. Calculations

Most calculations of colorimetric nature are performed by the software being used to operate the color measuring instrument. In normal cases of reference to this Evaluation Procedure it will not be necessary for the user to perform these calculations; however they are described in this Evaluation Procedure as a means of reference and standardization for those who may need to perform such calculations.

4.1 Tristimulus Values

4.1.1 The tristimulus values (X, Y, Z) are derived from spectral data and are the basis for all colorimetric calculations. The exact X, Y, Z values derived from a set of spectral data depend on several factors including the wavelength range (and interval) of measurement and the user's choice of illuminant/observer functions used in the calculation. While most calculations of tristimulus values are performed by computer programs, interested persons should refer to **ASTM Method E 308** (see 7.1) for definitive procedures (see 7.2).

4.2 1976 CIE L^*, a^*, b^*, C^* , and hue angle (h_{ab})

4.2.1 Calculate the $L^*, a^*, b^*, C^*_{ab}, h_{ab}$ values from the X, Y, Z tristimulus values for both the reference and specimen as follows:

$$L^* = 116(Y/Y_n)^{1/3} - 16$$

if $Y/Y_n > 0.008856$

but

$$L^* = 903.3 (Y/Y_n)$$

if

$$Y/Y_n \leq 0.008856$$

$$a^* = 500[f(X/X_n) - f(Y/Y_n)]$$

$$b^* = 200[f(Y/Y_n) - f(Z/Z_n)]$$

where:

$$f(X/X_n) = (X/X_n)^{1/3}$$

if

$$X/X_n > 0.008856$$

or

$$f(X/X_n) = 7.787(X/X_n) + 16/116$$

if

$$X/X_n \leq 0.008856$$

$$f(Y/Y_n) = (Y/Y_n)^{1/3}$$

if

$$Y/Y_n > 0.008856$$

or

$$f(Y/Y_n) = 7.787(Y/Y_n) + 16/116$$

if

$$Y/Y_n \leq 0.008856$$

$$f(Z/Z_n) = (Z/Z_n)^{1/3}$$

if

$$Z/Z_n > 0.008856$$

or

$$f(Z/Z_n) = 7.787(Z/Z_n) + 16/116$$

if

$$Z/Z_n \leq 0.008856$$

$$C^*_{ab} = (a^{*2} + b^{*2})^{1/2}$$

$$h_{ab} = \arctan(b^*/a^*) \text{ expressed on a } 0^\circ \text{ to } 360^\circ \text{ scale with the } a^* \text{ positive axis being } 0^\circ \text{ and the } b^* \text{ positive axis at } 90^\circ.$$

For these equations, X_n, Y_n and Z_n are the tristimulus values of the illuminant. For daylight the preferred illuminant/observer combination is $D_{65}/10^\circ$. Table I gives the values for all combinations in **ASTM Method E 308**.

4.3 Color Strength Value using Reflectance Measurement

4.3.1 Color Strength Value is a single numerical value related to the amount of color absorbing material (colorant) contained in a specimen. It is most often used

to calculate the difference in strength (% strength) between two colored specimens. Color Strength Value may be calculated by any one of **four** acceptable methods. The value which results from one method may not agree with any other method. The choice of method is usually dependent on the nature of the specimen and the need for obtaining a color strength value. Colorimeters must calculate this value using a tristimulus function method. The methods used are labeled as SWL, SUM, WSUM and TSVSTR, and are calculated as follows:

4.3.2 Color Strength Value of specimens measured on a spectrophotometer most often involves calculation of a **K/S value** at one or more wavelength intervals. The commonly used equation for calculation of the **K/S value** for opaque specimens (i.e., textiles) at a specified wavelength (λ) is:

$$K/S = ((1.0 - R_\lambda)^2)/(2.0R_\lambda)$$

where:

R_λ is the absorption coefficient of the specimen (the %R value normally measured by a spectrophotometer and normalized to 1.0 [i.e., 100% = 1.0]).

4.3.3 For applications where the Pineo correction form of the equation is required (generally for deeply dyed textiles), the formula used is:

$$K/S = (1.0 - (R_\lambda - s)^2)/2.0(R_\lambda - s)$$

where:

s is the minimum reflectance achievable in the deepest dyed shade and is used for all wavelengths.

4.3.4 The four types of Color Strength Value calculations that are most commonly used are:

(SWL) K/S at single wavelength (usually wavelength of maximum absorbance). Use equation 4.3.2 and calculate **K/S** for a single wavelength.

(SUM) K/S summed over wavelength interval within the visible spectrum. Use equation 4.3.2, calculate **K/S** at each desired wavelength interval and sum. The resulting value may be normalized by dividing it by the number of intervals summed.

(WSUM) K/S weighted by visual function (such as the $\bar{x}, \bar{y}, \bar{z}$ functions and the D_{65} illuminant energy function) and summed over a wavelength interval within the visible spectrum, then divided by the number of wavelength intervals summed.

$$WSUM = \sum_\lambda [(K/S)_\lambda * \bar{x}_\lambda * E_\lambda + (K/S)_\lambda + \bar{y}_\lambda * E_\lambda + (K/S)_\lambda * \bar{z}_\lambda * E_\lambda] / n$$

where:

K/S = K/S as calculated in equation 4.3.2 above

E = Energy of selected illuminant (normally D_{65})

$\bar{x}, \bar{y}, \bar{z}$ = tristimulus weighting values for selected observer (normally 10°)

n = number of wavelength intervals used

(TSVSTR) tristimulus color strength value (X, Y, Z function). Normally the Y value is used as a gross color strength value related to the visual lightness function, although either the X or Z may be chosen for measurement of components where the absorption characteristics are known and fall into

widely separated regions of the visible spectrum. In most applications, the smallest of the 3 tristimulus values (X, Y or Z) is chosen and is used in place of the %R value in equation in 4.3.2 above. While the TSVSTR equation is used in the textile industry, no specific scientific support of it can be found in normally accepted reference books.

NOTE: See 4.5 below to calculate the relative difference in strength between two specimens using one of these calculation methods.

4.4 Color Strength Value using Transmittance Measurement

4.4.1 Color Strength Value is a single numerical value related to the amount of color absorbing material (colorant) contained in a solution. It is most often used to calculate the difference in strength (% strength) between two colored solutions. Color Strength Value may be calculated by any one of **four** acceptable methods. The value which results from one method may not agree with any other method. The choice of method is usually dependent on the nature of the specimen and the need for obtaining a color strength value. Colorimeters must calculate this value using a tristimulus function method. The methods used are labelled as SWL, SUM, WSUM and TSVSTR, and are calculated as follows:

4.4.2 Color Strength Value of specimens measured on a spectrophotometer most often involves calculating an **absorbance value** at one or more wavelengths. The equation for calculating the **absorbance value** at a specified wavelength (λ) is:

$$A_\lambda = \log_{10} (1.0/\tau_\lambda)$$

where:

τ_λ is the internal transmittance of the specimen (the %T value normally measured by a spectrophotometer and normalized to 1.0 [i.e., 100% = 1.0]).

4.4.3 The four types of Color Strength Value calculations that are most commonly used are:

(SWL) absorbance at single wavelength (usually wavelength of maximum absorbance). Use equation in 4.4.2 and calculate **A** for a single wavelength.

(SUM) absorbance summed over wavelength interval within the visible spectrum. Use equation in 4.4.2, calculate **A** at each desired wavelength interval and sum. The resulting value may be normalized by dividing it by the number of intervals summed.

(WSUM) absorbance weighted by visual function (such as the $\bar{x}, \bar{y}, \bar{z}$ functions and the D_{65} illuminant energy function) and summed over a wavelength interval within the visible spectrum, then divided by the number of wavelength intervals summed.

Table I—Tristimulus Values for Illuminant/Observer Combinations

Illuminant/Observer Combinations	Tristimulus Values		
	X_n	Y_n	Z_n
	(Ten degree observer)		
A/10°	111.146	100.000	35.203
C/10°	97.285	100.000	116.145
D ₅₀ /10°	96.720	100.000	81.427
D ₅₅ /10°	95.799	100.000	90.926
D ₆₅ /10°	94.811	100.000	107.304
D ₇₅ /10°	94.416	100.000	120.641
F2/10° (Cool White Fluorescent)	103.279	100.000	69.027
F7/10° (Daylight Fluorescent)	95.792	100.000	107.686
F11/10° (Ultralum 4000, TL84)	103.863	100.000	65.607
	(Two degree observer)		
A/2°	109.850	100.000	35.585
C/2°	98.074	100.000	118.232
D ₅₀ /2°	96.422	100.000	82.521
D ₅₅ /2°	95.682	100.000	92.149
D ₆₅ /2°	95.047	100.000	108.883
D ₇₅ /2°	94.972	100.000	122.638
F2/2° (Cool White Fluorescent)	99.186	100.000	67.393
F7/2° (Daylight Fluorescent)	95.041	100.000	108.747
F11/2° (Daylight Fluorescent)	100.962	100.000	64.350

$$\text{WSUM} = \sum_{\lambda} [(A_{\lambda} * \bar{x}_{\lambda} * E_{\lambda}) + (A_{\lambda} * \bar{y}_{\lambda} * E_{\lambda}) + (A_{\lambda} * \bar{z}_{\lambda} * E_{\lambda})]/n$$

where:

- A = Absorbance calculated in equation in 4.4.2 above
 E = Energy of selected illuminant (normally D₆₅)
 $\bar{x}, \bar{y}, \bar{z}$ = tristimulus weighting values for selected observer (normally 10°)
 n = number of wavelength intervals used

(TSVSTR) tristimulus color strength value (X,Y,Z function). Normally the Y value is used as a gross color strength value related to the visual lightness function, although either the X or Z may be chosen for measurement of components where the absorption characteristics are known and fall into widely separated regions of the visible spectrum. In most applications, the smallest of the three tristimulus values (X, Y or Z) is chosen and is used in place of the %T value in equation in 4.4.2 above. While the TSVSTR equation is used in the textile industry, no specific scientific support of it can be found in normally accepted reference books.

4.5 Relative Strength

4.5.1 Color Strength Values calculated by the above method(s) may be used to calculate the relative difference in strength between two specimens, one of which is considered to be a standard. The result of this comparison yields a numerical quantity which is termed %strength.

$$\% \text{strength} = (\text{ColorStrValue}_{\text{specimen}} / \text{ColorStrValue}_{\text{standard}}) (100.0)$$

5. Reporting

Reporting of procedures and data accomplished through reference to this evaluation procedure should include, as a minimum, the following information:

- 5.1 The instrument geometry type that was used to measure the specimen(s).
- 5.2 The identification of the spectrophotometer or colorimeter used.
- 5.3 The illuminant/observer used to calculate the colorimetric values.
- 5.4 Identification of specimen.
- 5.5 The color strength value calculation (if any) used (SWL, SUM, WSUM, TSVSTR).
- 5.6 The specimen presentation and averaging methods employed, such as area-of-view, number of thicknesses, temperature and % relative humidity if not at standard conditions and number of readings in a measurement.

6. Precision and Bias

- 6.1 Evaluation Procedure 6 is meant to

be used as a supportive reference method. Specific precision and bias statements contained within each referring AATCC test method must be used to evaluate the significance of any colorimetric results obtained as part of that test method procedure. The user is cautioned that precision and bias are affected in part by sample presentation, averaging methods, and the repeatability and accuracy of the individual color measuring instrument used.

7. References

- 7.1 *ASTM Standards on Color and Appearance Measurement*, Fifth Edition 1995, ASTM, Philadelphia PA.
 - 7.1.1 ASTM E 1345; *Standard Practice for Reducing the Effect of Variability of Color Measurement by Use of Multiple Measurements*.
 - 7.1.2 ASTM E 308; *Standard Test Method for Computing the Colors of Objects by Using the CIE System*.
- 7.2 Publication CIE No. 15.2(1986), *Colorimetry*, Second Edition, Commission Internationale de l'Eclairage (CIE), Central Bureau of the CIE, Vienna, Austria. Available in the USA from Mr. Thomas Lemons, TLA—Lighting Consultants, Inc., 7 Pond St., Salem MA 01970. One method to verify that the correct calculations are being made is to enter 100% reflectance values into the computer program being used and have the system calculate the tristimulus values. These values should agree with the values in Table I (from ASTM E 308) to the second decimal place for the illuminant being checked.
- 7.3 SAE International, 400 Commonwealth Dr., Warrendale, PA 15096, Test Method SAE J1545; *Instrumental Color Difference Measurement for Exterior Finishes, Textiles and Colored Trim*.
- 7.4 Stearns, E. I., *The Practice of Absorption Spectrophotometry*, Wiley-Interscience, 1969.
- 7.5 Wyszecki and Stiles, *Color Science*, 2nd Ed.
- 7.6 ASTM D 1776; *Standard Practice for Conditioning of Textiles for Testing*.

APPENDIX A

A1. Reflectance Measurement Problems and Guidelines

A1.1 Fluorescence—For color measuring instruments which do not have the ability to control accurately the amount of UV energy illuminating the specimen, the operator may insert a UV-absorbing filter between the light source and the sample, effectively eliminating the UV induced fluorescence. Note that this technique may result in disagreement with visual results. Note also that this technique is only applicable in those cases where the fluorescence is caused by absorption of ultraviolet radiation. Instruments which can control the UV energy will produce results more consistent with visual observation, but these results may be harder to reproduce on other non-similar instruments. In either case when speci-

mens are fluorescent, all specimens to be compared must be measured on the same instrument at nearly the same time. Previously measured data (standards, controls, etc.) should not be used for direct comparison. Fluorescent specimens which absorb visible energy cannot be measured consistently except on an instrument where the quantity and quality of incident energy can be controlled. While such instruments do not currently exist commercially, the best alternative is to use a 0/45, 45/0 (circumferential or bidirectional) type measuring instrument (see CIE 15.2, Section 1.4, Note 8).

A1.2 Moisture Content—If the existence of moisture affects the measurement of color it is necessary to “condition” the specimens to allow the moisture content to stabilize. This conditioning should take place in a room or chamber where the temperature and humidity are constant, and enough time should be allowed for all samples to regain moisture to a reproducible amount. This is typically several hours for most specimens containing cotton or hydroscopic fiber, but can vary significantly with different ambient conditions. The condition of the specimen should be maintained as much as possible during measurement. Standard atmosphere for textile testing is defined by AATCC to be a relative humidity of 65% (± 2%) and ambient temperature of 21 ± 1°C (70 ± 2°F) (see 7.6).

A1.3 Non-Opaque—Most textile samples are non-opaque to some extent. All specimens **must** be measured using the same procedure. If sufficient quantity of material is available, it is advisable to layer the material until light will no longer penetrate through the layers. If the measurement of the specimen backed with a white tile is not significantly different to the measurement of the same specimen backed with a black tile, then the number of layers is considered sufficient. Note that many layers of soft material can cause other problems (see Non-Rigid below) and may require a compromise. In such cases it may be necessary to use a nominal number of layers (always the same number for each specimen measured) backed by the same material or tile that contains no fluorescent whitening agents.

A1.3.1 When it is not possible to achieve complete opacity a correction equation may be used which yields a corrected %R (R_∞) value. R_∞ is defined as the opaque reflectance of a layer so thick that no change in reflectance is seen between the over white and over black measurements. This procedure requires measurement of the specimen backed by a white tile, and measurement of the specimen backed by a black tile. The following equations are then used to produce a corrected %R value (R_∞) at each wavelength interval (see 7.5):

$$a = 0.5 [R_w + ((R_B - R_w + R_g) / (R_B R_g))] , \text{ then}$$

$$R_\infty = a - (a^2 - 1)^{1/2}$$

where:

R_w = R of specimen backed by white tile

R_B = R of specimen backed by black tile

R_g = R of white tile alone

Where R_w , R_B and R_g are expressed in decimal fraction form; i.e. 0-1.0.

A1.4 Non-Rigid—To avoid intrusion of soft specimens into the measuring port of the color measuring instrument use one of the following procedures:

A1.4.1 Winding, fastening, or mounting to a card or other sufficiently rigid structure. The backing structure must be of a neutral color, reproducible for all specimens to be measured and the opacity rules (see above) must be observed. When yarn specimens are wound onto cards it is necessary to control the tension, orientation, and thickness of the material to achieve reproducible results.

A1.4.2 A few instruments are designed to measure specimens without contacting their surfaces. Specimens to be measured must be flat, backed by a rigid structure and have sufficient thickness to eliminate any effects from non-opacity.

A1.4.3 Measurement of some specimens behind glass increases repeatability of color measurement for spectrophotometers, particularly on fiber and yarn specimens. The resulting reflectance measurements must be corrected by a glass correction equation, or the effects of the glass may bias the results. In addition, the amount of material and the pressure used to press the material against the glass must be controlled. The equation normally used is:

$$R_\lambda = (R_g + T_c - 1) / (R_g + T_c - 1.0 - (T_d * R_g) + T_d)$$

NOTE: All R and T values are expressed in decimal fraction form.

where:

R_g = measured %R behind glass

T_c = transmittance of glass to collimated light (nominally equal to 0.92 for glass with a refractive index of 1.50 and no absorption)

T_d = transmittance of glass to diffuse light (nominally equal to 0.87 for glass as described above)

R_λ = corrected % reflectance with no glass

NOTE: See 7.4. This form of the glass equation is derived from that in the reference, page 307.

A1.5 Sensitivity to Light or Heat—Specimens which are sensitive to light and/or heat are best measured in a color measuring instrument which exposes the

specimen to light for only a brief moment during the actual measurement. Flash illumination instruments and instruments with automatic light shutters provide mechanisms for limiting the amount of time that the specimen is exposed to light. Instruments which must scan the visible spectrum (taking several seconds to perform a single measurement) should not be used for these specimens. In all cases, sample preparation must include precautions for limiting the amount of light the specimen is exposed to prior to measurement. Instruments which illuminate the specimen monochromatically are also acceptable for measuring these types of specimens.

A1.6 Small Specimens—Specimens which are small enough to require the use of a SAV (small area view) option on the color measuring instrument must be read multiple times and averaged to improve the precision of the measurement. Specimens smaller than the area-of-view of the instrument cannot be measured reliably.

A1.7 Surface Texture—The difficulty in measuring specimens with pronounced physical surface characteristics first lies in the decision as to what physical attribute interests the user. The ability of an instrument to separate color from *appearance* is an advantage in some situations, and a disadvantage in others. When it is advisable to measure only the *color* of the specimen, the most effective means is to mount the specimen behind glass and apply enough pressure to eliminate any texture differences. The same precautions and requirements apply as in the use of glass for non-rigid samples above. When the texture of the surface results in *directionality variation*, the specimen may be measured in multiples of 4, rotating 90° after each measurement. All measurements are then averaged to produce a single set of colorimetric values. An example of such a procedure developed for automotive fabrics is SAE J1545 (see 7.3).

A1.8 Variation in Color—When the specimen to be measured is not uniform in color, measurement averaging (of spectral data from a spectrophotometer or tristimulus value data from a colorimeter) is necessary to achieve uniform, reproducible measurements. This requires determining the number of readings necessary for the area-of-view employed which, when averaged together to produce a single result, can be reproduced by repeating the procedure at random locations on the specimen (see SAE J1545).

A2. Transmittance Measurement Problems and Guidelines

A2.1 Chemical Instability—Solutions which are chemically unstable should not be measured. The reason for the instability must be determined and an appropriate procedure and/or solvent developed

which results in a stable solution.

A2.2 Foaming, Air Bubbles—The addition of a drop or two of isobutyl alcohol (2-methyl propanol) will help to remove any bubbles or foam during the specimen preparation phase. When adding the liquid specimen to the transmission cell, the operator should hold the cell at an angle and pour the solution down the side of the cell to minimize the formation of air bubbles.

A2.3 pH Sensitivity—Many dyes are sensitive to pH changes and will exhibit a marked shift in the color of the prepared specimen if the pH is changed. The use of distilled water (or demineralized water) as well as the addition of a pH buffer during preparation is usually required.

A2.4 Plating—Dye solutions (especially *Basic Class* dyes) have a tendency to form a single layer of dye molecules adhering to the walls of the glass transmission cell. The transmission cell should always be rinsed (or flushed) with the solution to be measured, emptied, then refilled with fresh solution before measuring the color. Note that this procedure assumes that the cell was clean (free of plating) prior to testing, and that all specimens are treated identically. Where practical, an instrument standardization measurement should be made immediately prior to the specimen measurement, and after the reference cell has been similarly flushed with the colored solution, then filled with clear solution (usually distilled water). If a dual beam instrument is being used (where both a specimen and reference cell are simultaneously employed in the measurement), the reference cell (containing clear solution) is flushed with the colored solution before being filled with the clear solution. In this case, the normal method of instrument standardization is sufficient.

A2.5 Sensitivity to Light or Heat (photochromism or thermochromism)—When possible transmission measurement should be performed using an instrument which illuminates the specimen monochromatically (at a single wavelength). If this is not possible, an instrument which provides a light blocking shutter, or which illuminates the specimen using a momentary flash of light may be used to reduce the effect.

A2.6 Resolution (wavelength interval)—In general, the transmission curves for dyes in solution have sharper, more pronounced peaks than those obtained from reflectance measurement. Spectrophotometers which measure at wavelength intervals of 10 nm or less are required to obtain accurate, reproducible results. In addition, the bandpass of the instrument being used must be less than or equal to 10 nm.

Instrumental Assessment of the Change in Color of a Test Specimen

Developed in 1995 by AATCC Committee RA36; reaffirmed 1996, 2003; revised and reaffirmed 1998. Technically equivalent to ISO 105-A05.

1. Scope

1.1 This evaluation procedure is intended as an alternative to the visual method of Evaluation Procedure 1, Gray Scale for Color Change (see 9.1), for assessing the change in color of a test specimen (see 9.2). It is applicable to any test method referring to Gray Scales except those which involve treatment with solutions containing fluorescent whitening agents (FWA).

2. Principle

2.1 The color of the specimen which has been submitted to the colorfastness test and the color of an identical untreated specimen are measured instrumentally. The CIELAB coordinates for lightness L^* , chroma C^*_{ab} , and hue h_{ab} are determined for both specimens as defined in CIE 15.2. The CIELAB differences ΔL^* , ΔC^*_{ab} , and ΔH^*_{ab} are calculated and converted to a gray scale grade by means of a series of equations.

3. Terminology

3.1 **color change**, n.—a change in color of any kind whether in lightness, hue or chroma or any combination of these, discernible by comparing the test specimen with a corresponding untested specimen.

3.2 **gray scale grade**, n.—for color change, (*GSc*), the numerical value that is assigned to the change in color of a test specimen as compared to an original or untreated specimen.

4. Apparatus

4.1 Spectrophotometer or colorimeter meeting any one of the geometric definitions described in CIE publication 15.2, subclause 1.4 (see 9.3).

5. Test and Reference Specimens

5.1 Choose a representative sample of material, which has been subjected to a colorfastness test, of adequate size to fit the sample holder of the instrument used. Back this specimen with enough thicknesses of the original material to make the specimen opaque. (Opacity, or at least

consistency, is required for accurate measurement.) Backing a single layer of the material with a white material that contains no FWAs is a permitted alternative provided both the reference specimen (original material) and test specimen are backed in an identical manner.

5.2 Form a layer of the reference specimen (original material) consisting of the same number of thicknesses as that prepared in 5.1.

6. Procedure

6.1 Measure the color of the reference specimen and calculate the CIELAB L^* , C^*_{ab} , and h_{ab} values using the data for the 10° observer and for illuminant D_{65} (see 9.4).

6.2 Measure the color of the test specimen which has been subjected to the colorfastness test and make the same colorimetric calculations as done for the reference specimen. Then make the calculations as described below in Section 7.

7. Calculations

7.1 The subscript ‘*M*’ is used to represent a function of the mean of the test and reference specimen. The subscript ‘*K*’ is used to represent chroma corrected hue functions. The subscript ‘*F*’ is used to represent the special gray scale color difference and separate this ΔE from others in normal use. The subscript ‘*T*’ is for the test specimen and the subscript ‘*R*’ is for the reference specimen.

7.2 Calculate ΔE_F using the equations:

$$\Delta E_F = [(\Delta L^*)^2 + (\Delta C^*_F)^2 + (\Delta H^*_F)^2]^{1/2}$$

$$\Delta H^*_F = \Delta H^*_K / [1 + (10 \cdot C_M / 1000)^2]$$

$$\Delta C^*_F = \Delta C^*_K / [1 + (20 \cdot C_M / 1000)^2]$$

$$\Delta H^*_K = \Delta H^*_{ab} - D$$

$$\Delta C^*_K = \Delta C^*_{ab} - D$$

$$D = (\Delta C^*_{ab} \cdot C_M \cdot e^{-x}) / 100$$

$$x = [(h_M - 280) / 30]^2$$

if $|h_M - 280| \leq 180$
 or $x = [(360 - |h_M - 280|) / 30]^2$
 if $|h_M - 280| > 180$
 $C_M = (C^*_{abT} + C^*_{abR}) / 2$
 $h_M = (h_{abT} + h_{abR}) / 2$
 if $|h_{abT} - h_{abR}| \leq 180$
 or $h_M = (h_{abT} + h_{abR}) / 2 + 180$
 if $|h_{abT} - h_{abR}| > 180$
 and $|h_{abT} + h_{abR}| < 360$

or

$$h_M = (h_{abT} + h_{abR}) / 2 - 180$$

if

$$|h_{abT} - h_{abR}| > 180$$

and

$$|h_{abT} + h_{abR}| \geq 360$$

$L^*_{T}, C^*_{abT}, h_{abT}$ = CIELAB lightness, chroma and hue of Test specimen (see 9.5)

$L^*_{R}, C^*_{abR}, h_{abR}$ = CIELAB lightness, chroma and hue of Reference specimen (see 10.5)

$$\Delta L^* = L^*_T - L^*_R$$

$$\Delta C^*_{ab} = C^*_{abT} - C^*_{abR}$$

$$\text{sign of } \Delta H^*_{ab} = \text{sign of } (h_{abT} - h_{abR})$$

$$\Delta H^*_{ab} = [(\Delta E^*_{ab})^2 - (\Delta L^*)^2 - (\Delta C^*_{ab})^2]^{1/2}$$

$$\Delta E^*_{ab} = [(\Delta L^*)^2 + (\Delta a^*)^2 + (\Delta b^*)^2]^{1/2}$$

7.3 Calculate the gray scale grade for color change (*GSc*) according to Table I or according to the function in 7.3.1.

7.3.1 Function.

$$GSc = 5 - \Delta E_F / 1.7$$

when

$$(\Delta E_F \leq 3.4)$$

$$GSc = 5 - \text{Log} (\Delta E_F / 0.85) / \text{Log} (2)$$

when

$$(\Delta E_F > 3.4)$$

The function produces continuous decimal values of grade compared to the step values that are obtained from the table.

8. Report

8.1 The report should contain, as a minimum, the following information:

8.1.1 The Gray Scale Grade(s) [*GSc* value(s)] for change in color of the specimen(s); follow the directions and report as directed in the appropriate test method.

8.1.2 The number and date of this procedure; i.e., AATCC EP 7: 1998;

8.1.3 All details necessary for the identification of the sample(s) tested;

8.1.4 Which of the optional CIE geometry types was used;

8.1.5 Identification of the spectropho-

Table I—Gray Scale Color Change Step Values

ΔE_F	ΔE_F	GSc
< 0.40	< 0.40	5
≥ 0.40	< 1.25	4-5
≥ 1.25	< 2.10	4
≥ 2.10	< 2.95	3-4
≥ 2.95	< 4.10	3
≥ 4.10	< 5.80	2-3
≥ 5.80	< 8.20	2
≥ 8.20	< 11.60	1-2
≥ 11.60	< 11.60	1

tometer or colorimeter used;

8.1.6 Whether illuminant D_{65} or illuminant C was used;

8.1.7 Whether the 1964 10° or the 1931 2° observer was used.

9. Notes and References

9.1 AATCC TECHNICAL MANUAL, American Association of Textile Chemists and

Colorists, AATCC Evaluation Procedure 1, Gray Scale for Color Change. Available from AATCC, P.O. Box 12215, Research Triangle Park NC 27709; tel: 919/549-8141; fax: 919/549-8933; e-mail: orders@aatcc.org.

9.2 Jaeckel, S. M., The Variability of Grey-Scale Assessment and its Contribution to the Variability of a Test Method, *Journal of The Society of Dyers and Colourist*, Vol. 96, 1980, p540-544.

9.3 Commission Internationale de l'Éclairage, Publication CIE No. 15.2, *Colorimetry*, 2nd ed., Central Bureau of the CIE, Vienna, 1986. Available from USNC-CIE Publications Office, TLA Lighting Consultants, Inc., 7 Pond St., Salem MA 01970.

9.4 Permitted alternatives are $D_{65}/2^\circ$, $C/2^\circ$, and $C/10^\circ$.

9.5 AATCC Test Method 173, CMC: Calculation of Small Color Differences for Acceptability, and reference 9.3.

AATCC 9-Step Chromatic Transference Scale

Developed in 1996 by AATCC Committees RA36/RA38; under jurisdiction of AATCC Committee RA36; reaffirmed and editorially revised 1997, 1998; revised 2002.

1. Scope

1.1 This evaluation procedure describes the use of a 9-step Chromatic Transference Scale for evaluating staining on undyed textiles in colorfastness tests.

2. Principle

2.1 The staining of undyed cloth in colorfastness tests is rated by visually comparing the color of the stained cloth and unstained cloth to the differences in color represented by the Scale (see 7.1).

3. Terminology

3.1 **colorant staining**, *n.*— the unintended pickup of colorant by a substrate due to (1) exposure to a colored or contaminated liquid medium or (2) direct contact with dyed or pigmented material, from which colorant transfers by sublimation or mechanical action (as in crocking).

3.2 **colorfastness**, *n.*—the resistance of a material to change in any of its color characteristics, to transfer of its colorant(s) to adjacent materials or both, as a result of the exposure of the material to any environment that might be encountered during the processing, testing, storage or use of the material.

3.3 **grade**, *n.*—in *textile testing*, the symbol for any step of a multistep standard reference scale for a quality characteristic.

NOTE: The grade is assigned to test specimens exhibiting a degree of the quality comparable to that step of the standard. Numerical grades assigned to different specimens from a sample or by different observers are commonly averaged.

3.4 **rating**, *v.*—in *textile testing*, the process for determining or assigning a grade to a material by comparing it to a standard reference scale.

4. Description of Scale

4.1 The Scale makes use of 60 color chips. The five hues (red, yellow, green, blue and purple) were selected from the *Munsell Book of Color*. The neutral chip representing row number 5 as well as the neutral gray chips correspond to the gray chips on the Gray Scale for Staining (see

7.1).

4.2 The chips on the Scale appear on white cardboard in ten rows. The rows are placed and aligned so that every color shows a similar gradation in depth in a vertical line, ranging from the lightest colors on top to the darkest colors on the bottom. For rating purposes, the rows are designated numerically with number 5 being assigned to the top row which depicts no color, number 4.5 to the second row or lightest colors and so on down to number 1 for the bottom row or darkest colors. Nominal $L^*a^*b^*$ values (see 7.2) and Munsell Notations of each chip are given in Table I and are included with the Scale (see 7.3).

4.3 The chips are mounted in rows with sufficient separation between them to show 9.5 mm (3/8 in.) circular holes cut in the card between rows of chips in the ten rows. A white cardboard mask, as shown in Fig. 1, is provided so that when it is held vertically over the scale, it discloses one of the circular openings in the color scale and the two adjacent color chips (see 7.4).

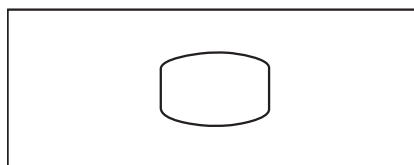

Fig. 1—White cardboard mask.

5. Use of the Scale

5.1 Illuminate the surfaces with a daylight simulator with illumination level at the specimen plane in the range of 1080-1340 lx (100-125 fc) (see 7.5). The light should be incident upon the surfaces at $90 \pm 5^\circ$ and the direction of viewing $45 \pm 5^\circ$ to the plane of the surfaces (see Fig. 2).

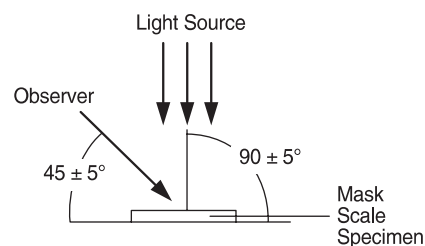

Fig. 2—Illumination and viewing angle for rating specimens.

5.2 The material exhibiting the transferred color to be evaluated is placed behind the card on which the chips are mounted, so that a representative part of the colored portion is visible through one of the circular holes in the column closest to it in hue. Before rating a color transferred to a thin material such as white cotton sheeting, the test specimen should be backed with a number of layers of the clean test cloth. This applies also to samples of thin material showing transferred color mounted on test cards. The color of the cardboard will influence the judgment of the examiner, unless the color of the card is eliminated by adding several layers of clean test material behind the specimen showing color transfer. This can be done without removing the sample from the card. With the mask in place, the specimen and the mask are then moved up or down in this column until the specimen most closely approximates the chroma of one of the chips in the column. In order to eliminate or minimize the shadow on the specimen through the holes on the Scale, the Scale should be held so that the specimen and the Scale are perpendicular to the light source.

5.3 Numerical grades are determined by comparison with the numbered rows on the Scale. The rating method given in the Scale is as follows:

Colorant Staining (Transfer)	Grade
No transfer	5
Transfer equal to Row 4.5	4.5
Transfer equal to Row 4	4
Transfer equal to Row 3.5	3.5
Transfer equal to Row 3	3
Transfer equal to Row 2.5	2.5
Transfer equal to Row 2	2
Transfer equal to Row 1.5	1.5
Transfer equal to Row 1	1

6. Evaluation of Results

6.1 Evaluations made with a 9-Step Chromatic Transference Scale should give essentially the same grades as evaluations made with either the Gray Scale for Staining or the 5-Step Chromatic Transference Scale (see 7.1)

6.2 The 9-Step Chromatic Transference Scale is believed to fulfill evaluation requirements when the results are analyzed on a statistical basis. It may facilitate evaluations of staining, especially when used by less experienced raters.

6.3 Reports on grades arrived at by the

Table I

Grade	Munsell Notations and L*a*b* Values					
5	N9.34/ L* = 94.11 a* = -0.01 b* = -0.01	N9.34/ L* = 94.11 a* = -0.01 b* = -0.01	N9.34/ L* = 94.11 a* = -0.01 b* = -0.01	N9.34/ L* = 94.11 a* = -0.01 b* = -0.01	N9.34/ L* = 94.11 a* = -0.01 b* = -0.01	N9.34/ L* = 94.11 a* = -0.01 b* = -0.01
4.5	N9.12/ L* = 91.99 a* = -0.01 b* = -0.01	5R 9.12/1 L* = 91.99 a* = 2.81 b* = 1.61	5Y 9.12/1 L* = 91.99 a* = -1.31 b* = 8.23	10GY 9.12/1 L* = 91.99 a* = -6.29 b* = 5.33	2.5PB 9.12/1 L* = 91.99 a* = -0.77 b* = -2.81	10P 9.12/1 L* = 91.99 a* = 2.35 b* = -1.04
4	N8.91/ L* = 89.98 a* = -0.01 b* = -0.01	5R 8.91/2 L* = 89.98 a* = 5.51 b* = 3.12	5Y 8.91/2 L* = 89.98 a* = -2.40 b* = 16.25	10GY 8.91/2 L* = 89.98 a* = -11.94 b* = 10.38	2.5PB 8.91/2 L* = 89.98 a* = -1.64 b* = -5.64	10P 8.91/2 L* = 89.98 a* = 4.67 b* = -2.10
3.5	N8.73/ L* = 88.25 a* = -0.01 b* = -0.01	5R 8.73/3 L* = 88.25 a* = 10.41 b* = 5.78	5Y 8.73/3 L* = 88.25 a* = -3.05 b* = 23.10	10GY 8.73/3 L* = 88.25 a* = -16.60 b* = 14.69	2.5PB 8.73/3 L* = 88.25 a* = -3.02 b* = -10.26	10P 8.73/3 L* = 88.25 a* = 8.88 b* = -4.10
3	N8.45/ L* = 85.57 a* = -0.01 b* = -0.01	5R 8.45/4 L* = 85.57 a* = 14.98 b* = 8.36	5Y 8.45/4 L* = 85.57 a* = -3.49 b* = 29.70	10GY 8.45/4 L* = 85.57 a* = -20.78 b* = 18.72	2.5PB 8.45/4 L* = 85.57 a* = -4.35 b* = -14.61	10P 8.45/4 L* = 85.57 a* = 12.99 b* = -6.16
2.5	N8.10/ L* = 82.23 a* = -0.01 b* = -0.01	5R 8.10/5 L* = 82.23 a* = 18.95 b* = 10.47	5Y 8.10/5 L* = 82.23 a* = -3.56 b* = 35.96	10GY 8.10/5 L* = 82.23 a* = -25.08 b* = 22.52	2.5PB 8.10/5 L* = 82.23 a* = -5.00 b* = -18.57	10P 8.10/5 L* = 82.23 a* = 16.63 b* = -8.10
2	N7.58/ L* = 77.24 a* = -0.01 b* = -0.01	5R 7.58/6 L* = 77.24 a* = 22.98 b* = 12.54	5Y 7.58/6 L* = 77.24 a* = -3.31 b* = 42.83	10GY 7.58/6 L* = 77.24 a* = -28.86 b* = 25.81	2.5PB 7.58/6 L* = 77.24 a* = -5.46 b* = -22.44	10P 7.58/6 L* = 77.24 a* = 20.70 b* = -10.07
1.5	N6.86/ L* = 70.29 a* = -0.01 b* = -0.01	5R 6.86/7 L* = 70.29 a* = 27.29 b* = 14.51	5Y 6.86/7 L* = 70.29 a* = -2.49 b* = 49.27	10GY 6.86/7 L* = 70.29 a* = -32.65 b* = 28.91	2.5PB 6.86/7 L* = 70.29 a* = -5.33 b* = -26.10	10P 6.86/7 L* = 70.29 a* = 24.79 b* = -12.27
1	N5.84/ L* = 60.25 a* = -0.01 b* = -0.01	5R 5.84/8 L* = 60.25 a* = 31.87 b* = 16.64	5Y 5.84/8 L* = 60.25 a* = -1.16 b* = 56.91	10GY 5.84/8 L* = 60.25 a* = -37.36 b* = 32.66	2.5PB 5.84/8 L* = 60.25 a* = -4.79 b* = -30.73	10P 5.84/8 L* = 60.25 a* = 29.11 b* = -14.88

use of the 9-Step Chromatic Transference Scale must clearly state that this scale was used and not the Gray Scale for Staining or the 5-Step Chromatic Transference Scale.

7. Notes

7.1 Available from AATCC, P.O. Box 12215, Research Triangle Park NC 27709; tel: 919/549-8141; fax: 919/549-8933; e-mail: orders@aatcc.org.

7.2 Sphere geometry spectrophotometric measurements of the chips shall be taken with the specular component included. A 0°/45° (45°/0°) geometry is an acceptable alternate. The colorimetric data shall be calculated using the CIE 1964 10° observer data for

Illuminant D₆₅.

7.3 Provision for a grade lower than 1 is provided for in *Nomenclature for Subjective Rating Processes* elsewhere in this MANUAL. Any test specimen which has a change in contrast decidedly greater than a grade of 1 may be rated a 0.

7.4 The cleanliness and physical condition of the Scale is extremely important in obtaining consistent results. Inspect the Scale frequently for fingerprints and any other marks. If the marks are considered to interfere with the ratings, then the Scale should be replaced. The Scale can also be physically damaged through handling. Again, if the physical damage to the chips; e.g., chipped edges, loose or buckled chips; interferes with the rating process, replace the

Scale. At least annually, the Scale should be measured on a spectrophotometer or colorimeter to ensure that the total color differences are within specification. Measure the colors on the Scale upon receipt and, using the initial color readings, total color difference for each chip should not exceed a ΔE_{CMC} value of 0.3. A CMC ratio of 2:1 should be used (ΔE_{CMC} computed from the nominal values listed in Table I will likely differ from the actual ΔE_{CMC} obtained from measurement of original and stained test crock squares). Keep the Scale in its case when it is not in use.

7.5 See AATCC Evaluation Procedure 9, Visual Assessment of Color Difference of Textiles, for notes on choice of daylight simulator and illumination level.

Visual Assessment of Color Difference of Textiles

Developed in 1999 by AATCC Committee RA36; revised 2002.

1. Purpose and Scope

1.1 This evaluation procedure provides general principles and a procedure for determining and describing the color difference of test specimens by visual comparison with a standard. The scope is to standardize the procedure for visual color difference evaluations of textile materials.

2. Principle

2.1 The color of a specimen or specimens and a reference standard are compared and evaluated under specific lighting and viewing conditions. The observed color difference can also be compared with tolerance range specimens.

3. Terminology

3.1 **chroma**, n.—the proportion of spectrally pure color that expresses the degree of departure from the gray of the same lightness; i.e., brighter or duller.

3.2 **hue**, n.—the attribute of color perception by means of which an object is judged to be red, orange, yellow, green, blue, violet or a combination of these.

3.3 **lightness**, n.—the amount of light reflected from a non-self-luminous textile material or the attribute of color perception by which such a surface is judged to reflect more or less light than another surface; i.e., darker or lighter.

3.4 **metamerism**, n.—the attribute of two colored materials, which match under one illuminant and to one observer, but do not match when exposed to a different illuminant (having a different spectral power distribution) or when viewed by another observer.

3.5 **reference standard**, n.—a material that defines the specific color to be matched, and may also be used to define other appearance properties, such as finish, texture and construction.

3.6 **tolerance range specimens**, n.—selected specimens which deviate from the reference standard in hue, lightness, chroma, or in combinations of the three, and impose a range of observable color differences around the reference standard for evaluation purposes.

4. Uses and Limitations

4.1 This evaluation procedure is used

for the determination and description of the magnitude of color difference of textile materials against a standard color specimen.

4.2 When evaluating multicolored patterns, each color is evaluated separately.

4.3 To determine if illuminant metamerism is present, evaluate specimens under more than one illuminant.

4.4 Only observers whose color vision has been tested normal using either the Farnsworth Munsell 100 Hue Test (see 10.1) or the HVC Color Skills Test (see 10.2) for color acuity shall perform this procedure.

5. Apparatus

5.1 Illumination conditions. The source under which the comparison is made shall be determined prior to evaluation. Sources simulating any of the following CIE illuminants may be utilized (see 10.3 and 10.4):

Illuminant	Description	Color Temperature
D ₆₅	Daylight	6500K ± 200
D ₇₅	Daylight	7500K ± 200
A	Incandescent	2856K ± 200
F2	Cool White Fluorescent	4230K ± 200

Note: Exceptions to these sources are negotiable by the contractual parties.

5.1.1 Specimens may be viewed with UV illumination to test for the presence of Fluorescent Whitening Agents (FWAs).

5.1.2 The recommended illumination level at the specimen plane is in range of 1080-1340 lx (100-125 fc) (see 10.5).

5.2 Viewing environment. The specimens will be placed on a flat, uniform surface having no distortions or depressions, matching the range of grays from Munsell N5/ to N8/, depending on the color of the reference standard (see 10.5). The area surrounding the viewing area shall be a matte surface matching Munsell N6/ to N8/. The viewing environment shall contain no other items, and shall be shielded from extraneous light. Observers shall wear clothing of neutral color, and there shall be no reflection on the specimens from surrounding surfaces. Table I summarizes the recommendations of

ASTM Standard D 1729-96 for evaluation environment, for both general and critical color difference determinations. The recommendations contained in Table I are more restrictive than this procedure, but are within the limits described above.

5.3 Viewing geometry.

5.3.1 Option A. The specimen plane and illumination source shall be parallel to each other and aligned so that the light flux is incident at the center of the specimen plane, which is set at a $35 \pm 5^\circ$ angle relative to the horizontal. The observer shall view the specimens at a 90° angle, relative to the plane of the specimens. This option shall not be used for evaluations of glossy or non-matte specimens. The observer shall take care when evaluating specimens not to block the incident light from the source.

5.3.2 Option B. The illumination source is horizontal. The specimen plane shall be horizontal, resulting in illumination incident at a 90° angle, relative to the specimen plane. The observer shall view at a $45 \pm 5^\circ$ angle relative to the specimen. This option shall be used for either glossy or matte specimens.

5.3.3 Option C. The illumination source is horizontal. The specimen plane shall be at a $45 \pm 5^\circ$ angle to horizontal, resulting in illumination incident at a 45° angle relative to the specimen plane. The observer shall view at a 90° angle relative to the specimen. This option shall be used for either glossy or matte specimens.

5.3.4 Option D. The illumination source is horizontal. The specimen plane shall be adjustable and set at an angle to the horizontal. The viewing angle of the observer to the specimen, therefore, will vary accordingly. When using this option, it must be reported at which angle the specimen plane is set. This option shall be used for either glossy or matte specimens.

5.3.4.1 Examples (see Fig. 1). Option D is the preferred viewing position.

5.4 Color Temperature Meter or Photometer. Check with the manufacturer of the viewing environment for "acceptable" illuminance and chromaticity coordinates for each of the illuminant simulators. Insure that the color temperature

Table I—Color of Background and Surround

Evaluation Category	Color of Background	Color of Surround	Maximum Munsell Chroma of Background and Surround
Critical	similar to standard	N6/ to N7/	0.2
General	N5/ to N7/	N6/ to N7/	0.3

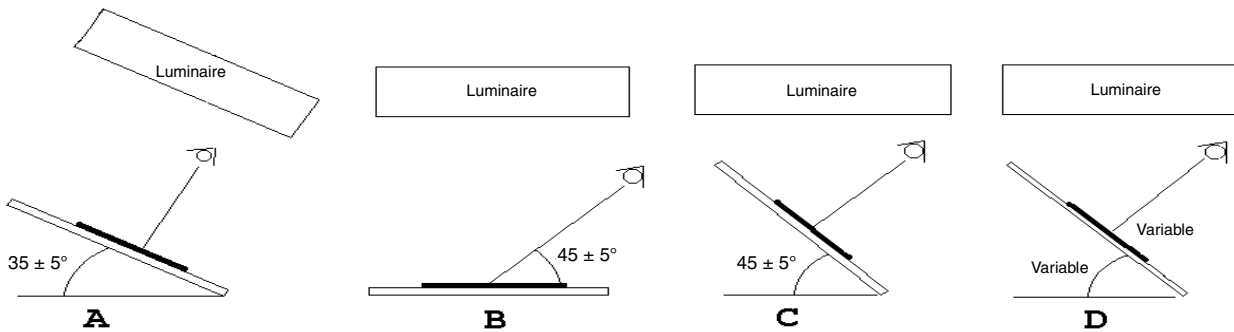

Fig. 1—Viewing positions for Options A, B, C and D (preferred option).

meter or photometer is within factory calibration specifications. Prior to measurement, the illuminant simulators should be powered on and allowed to stabilize. Generally this may take from 15-30 min. Place the instrument inside the illuminated viewing area. The instrument's sensor should be facing the incident light, placed on the viewing area floor and in the center. Without obstructing the path between the incident light and the sensor, measure and record the colorimetric data and/or illuminance data. Determine that the viewing environment is within the manufacturer's specifications.

6. Test Specimens

6.1 Prior to comparison, all color standards and test specimens shall be conditioned to avoid differences, which may be caused by temperature and humidity (see 10.8).

6.2 Recommended specimen sizes noted below are to be used only if the test method being used does not include specimen size requirements (see 10.7).

6.3 Dyed woven or knitted cloths. The test specimen shall be a representative rectangle of cloth, a minimum dimension of 100 mm in the lengthwise direction by 200 mm wide, whenever possible. Multi-colored specimens shall be of size to incorporate all colors in the pattern. All surfaces shall be clean and free from stains or soiling. Remove torn edges, markings, or other marks from the specimen. Specimens shall be cut at least 150 mm from the selvage, and seam areas shall be avoided.

6.4 Narrow cloths, braids, tapes, webbings. The test specimen shall be a minimum of 200 mm in length and full width, as received.

6.5 Loose fiber. The test specimen shall be carded and made into a suitable size lap or pad.

6.6 Threads and yarns. The test specimen shall be in skein form, wound on a card to form a compact area of parallel yarns, or knitted to suitable size. Card windings shall be of sufficient thickness

to conceal the card. The card shall not be bowed by tension of the wound yarns.

7. Procedures

7.1 The lighting conditions at the specimen plane shall be tested using a color temperature meter to ensure compliance with the specification in 5.1 above. In addition, the user shall test the viewing area for illumination uniformity. The intensity of illumination shall not deviate more than 25% from the center to the viewing edges of the specimen.

7.1.1 The illuminant simulator shall be tested four times per year, or as recommended by the equipment manufacturer (see 10.4).

7.2 Different color difference evaluation procedures, as listed below under 7.2.1 and 7.2.2, may be required for different applications. Each of these procedures may be used with apparatus from Options A, B, C or D. Observers shall allow their vision to become adapted to the lighting conditions for at least 2 min prior to making an evaluation. This requirement shall apply again if the lighting conditions are changed; i.e., use of another source.

7.2.1 Tolerance range specimen procedure. The reference standard shall be placed on the specimen plane. The tolerance range specimens shall be placed around the edge of the reference standard, contacting it at its edges. The test specimen shall be placed on the specimen plane adjacent to the standard with lengthwise directions parallel. The reference standard and specimen shall both face up unless otherwise specified. Any directional specimens shall be oriented in the same direction. Non-directional specimens shall be placed with their lengths in the same or opposite (180° rotation) orientation. The viewing distance shall be 700 ± 150 mm while performing the color difference evaluation.

7.2.2 Test specimen vs. reference standard procedure. The test specimen shall be placed on the specimen plane adjacent to the reference standard with lengthwise

directions parallel and adjacent. The reference standard and specimen shall both face up unless otherwise specified. Any directional specimens shall be oriented in the same direction. Non-directional specimens shall be placed with lengthwise directions in the same or opposite (180° rotation) orientation. The observer shall stand in front of, and perpendicular to the specimen plane, taking care to avoid blocking the light. The viewing distance shall be 700 ± 150 mm while performing the evaluation.

7.3 Multiple specimen procedure. Evaluations should be made as quickly as possible, since prolonged viewing affects the observers' ability to evaluate.

8. Evaluation

8.1 Determine the color difference in terms of lightness, chromaticity and hue relative to the standard.

8.2 Evaluation options:

8.2.1 Tolerance range evaluation. The observer shall determine if the color difference between the reference standard and a test specimen is within the tolerance range, or is greater than the tolerance range.

8.2.1.1 A description of the color difference between the reference standard and a test specimen shall include terms as designated in Table II.

Table II—Color Difference Direction Descriptors

Lightness	Lighter, Darker
Chroma	Brighter (or more chroma), Duller (or less chroma)
Hue	Redder, Greener, Yellower, Bluer

8.2.2 Magnitude evaluation. The observer shall determine the magnitude of color difference between a test specimen and reference standard by assigning values from Table III. For evaluating color changes resulting from colorfastness tests, see AATCC Evaluation Procedure 1. See 10.9 for specific application within

Table III—Color Difference Magnitude Descriptors

Verbal Description	Gray Scale for Color Change Corresponding Grade
Equal	5
Slight	4
Noticeable	3
Considerable	2
Much	1
Off Shade	0

the dyestuff industry. See 10.10 for additional description of use of magnitude descriptors.

9. Report

9.1 The color difference between each specimen and reference standard shall be reported, according to the test method used. A within-tolerance evaluation which approaches the limits of the tolerance range should be reported.

9.2 Any deviations from the specified apparatus, procedure, and/or evaluation shall be documented.

9.3 As a minimum, the following information should be included when referring to data acquired using this evaluation procedure:

9.3.1 Specimen identification and date of evaluation,

9.3.2 Illuminant simulator under which evaluation was performed,

9.3.3 Geometry option used (A, B, C, or D),

9.3.4 Specimen type (flat goods, wound card, carpet, etc.),

9.3.5 Specimen condition (number of thicknesses, pile lay, etc.).

9.3.6 Evaluation option and result:

9.3.6.1 Color difference direction descriptor,

9.3.6.2 Color difference magnitude descriptor.

9.4 Operator and site where evaluation performed.

10. Notes

10.1 The Farnsworth Munsell 100 Hue Test is available from Munsell Division of Gretag-Macbeth, 617 Little Britain Rd., New Windsor NY 12553, tel: 800/622-2384.

10.2 The HVC Color Vision Skill Test may be obtained from Colwell General Inc., Colorcurve Systems Inc., 200 6th St., Fort Wayne IN 46808; tel: 219/424-5000.

10.3 For visual assessments to be made under daylight illumination, it is recommended that the correlated color temperature be calibrated to 6500 K (± 200 K) and that the quality of daylight simulation be preferably rated as BC (CIELAB) or better, as determined by the method specified in CIE Publication 51, *A Method for Assessing the Quality of Daylight Simulators for Colorimetry*, available from CIE/USA Publications, TLA Lighting Consultants, Inc., 7 Pond St., Salem MA 01870. The above rating is the same as that specified in ASTM D 1729-96, Standard Practice for Visual Appraisal of Colors and Color Differences of Diffusely-Illuminated Opaque Materials.

10.4 Filters and lamps shall be properly maintained and cleaned periodically following manufacturers' recommendations.

10.5 The illumination range of 1080-1340 lx (100-125 fc) is recommended for critical visual assessment of materials of medium lightness and is the same range specified for critical visual assessment in ASTM D 1729-96, Standard Practice for Visual Appraisal of Colors and Color Differences of Diffusely-Illuminated Opaque Materials. However, when viewing very light or very dark materials the illumination may be varied as described in ASTM D 1729-96: "*For critical evaluation of color differences of specimens of medium lightness, the illumination at the center of the viewed area shall be 100-125 fc (1080-1340 lx). For general evaluation of*

specimens of intermediate lightness, the illumination shall be 75-175 fc (810-1880 lx). In either case, for viewing very light materials, the illumination may be as low as 50 fc (540 lx), and for viewing very dark materials, it may be as high as 200 fc (2150 lx). This higher level of illumination is usually obtained by holding the specimens nearer the source."

10.6 Samples of Munsell neutral color N5/ to N8/ may be obtained from Munsell Division of GretagMacbeth, 617 Little Britain Rd., New Windsor NY 12553, tel: 800/622-2384.

10.7 See AATCC Evaluation Procedure 6, *Instrumental Color Measurement*, Section 2.6 "Specimen Preparation" for additional recommendations for various specimen types, as included in the AATCC TECHNICAL MANUAL.

10.8 See AATCC Evaluation Procedure 6, *Instrumental Color Measurement*, Appendix A1.2-Moisture Content, for details regarding specimen conditioning.

10.9 Specific application for the dyestuff industry: During formulation, synthesis and standardization, the reference standard and test specimen shall be dyed in steps; i.e., reference standard at 95%, 100% and 105%, and the test specimen at 95% and 100%, to facilitate the determination of the test specimen strength compared to the reference standard. This evaluation is performed by placing a test specimen between two reference standards of varying strengths to determine one reference standard and one test specimen which appear equal or near-equal in tinctorial strength. Once this is done, the selected pair is evaluated as in 8.2 for the color difference direction and magnitude descriptors with respect to chromaticity and hue. Lightness magnitude and direction are often omitted in this case, due to the determination of strength.

10.10 Table III includes whole-step designations only, conforming to AATCC Monograph on Nomenclature for *Subjective Rating Processes*. See section on "Degree of Alteration in Lightness, Hue, and Chroma of Color." Some industries require half-step grades, with application-specific language to describe the intermediate steps. For example, the term "trace" is widely used for the 4-5 grade within the automotive industry.

Procedure for the Evaluation of Multifiber Adjacent Fabrics

Developed in 2005 by AATCC Committee RA59.

1. Purpose and Scope

1.1 This procedure is intended to permit the qualification of candidate multifiber test fabrics, by comparing the staining of their components with that of a control multifiber fabric, under controlled conditions.

2. Principle

2.1 The staining properties of individual components of candidate multifiber test fabrics are evaluated by comparing the shades obtained on them and on the components of a control fabric, using a soap solution and each of four different dye baths. The bath containing the yellow disperse dye, Terasil Yellow 2GE 200%, stains the secondary acetate and polyamide components (of the control fabrics and fabrics under test); the bath containing the orange acid dye, Irgalan Orange RL-KWL 250%, stains the polyamide components; the bath containing the blue direct dye, Solophenyl Blue GL 250%, stains the cotton components; and, the bath containing the navy disperse dye, Terasil Navy Blue BGLN 200%, stains the polyester and polyamide components. Evaluations of the stained components are conducted by colorimetric measurements to eliminate the subjectivity of visual evaluations.

3. Safety Precautions

NOTE: These safety procedures are for information purposes only. The precautions are ancillary to the testing procedures and not intended to be all inclusive. It is the user's responsibility to use safe and proper techniques in handling materials in this procedure. Manufacturers MUST be consulted for specific details such as material safety data sheets and other manufacturer's recommendations.

3.1 Good laboratory practices should be followed. Wear safety glasses in all laboratory areas.

3.2 All chemicals should be handled with care.

3.3 Manufacturer's safety recommendations should be followed when operating laboratory testing equipment.

4. Uses and Limitations

4.1 The procedure was tested on multifiber test fabrics containing 15 mm wide fiber stripes. Multifiber test fabrics containing narrower fiber stripes may also be evaluated as long as the aperture on the spectrophotometer used will accommodate the smaller size.

4.2 This procedure was developed using Staining Scale Rating (SSR) values as calculated in ISO 105-A04 (see 15.4). These calculated SSR values are used to assign the reported Gray Scale for Staining (see 15.5). This reported value is based upon a range that is broader than would be found by using the calculated SSR values between 4 and 3 (see 15.5).

5. Apparatus and Materials

5.1 Launder-Ometer.

5.1.1 A laundering machine for rotating closed canisters in a thermostatically controlled water bath at 40 ± 2 rpm (see 15.1).

5.1.2 Stainless steel lever lock canisters Type 1 (see 15.1), 500 mL (1 pt), 75×125 mm (3.0×5.0 in.)

5.1.3 Stainless steel lever lock canisters Type 2 (see 15.1), 1200 mL, 90×200 mm (3.5×8.0 in.)

5.1.4 Adapter plates for holding canisters (see 5.1.3) on laundering machine shaft (see 15.1).

5.1.5 Teflon fluorocarbon gaskets (see 11.5, 15.1 and 15.2).

5.2 Spectrophotometer geometry $d/0^\circ$ specular included, small area view; calculation

$D_{65}/10^\circ$; tolerance ΔE_{cmc} 0.5

5.3 pH meter accurate to ± 0.01 .

5.4 Balance with a weighing accuracy of ± 0.001 g.

5.5 Control Multifiber Fabric (see 15.6)

6. Reagents

6.1 Soap, specified in ISO 105-C02 (see 15.3, 15.4).

6.2 Terasil Yellow 2GE 200% (see 15.3).

6.3 Irgalan Orange RL-KWL 250% (see 15.3).

6.4 Solophenyl Blue GL 250% (see 15.3).

6.5 Terasil Navy Blue BGLN 200% (see 15.3).

6.6 Distilled or Deionized water.

7. Specimens

7.1 Multifiber fabric, to be used as a control (see 15.6); Weight: (3.00 ± 0.1) g.

7.2 Multifiber fabric under test; Weight: (3.00 ± 0.1) g; approximately 100×100 mm.

7.3 Mark the specimens to distinguish between the control specimens and the specimens under test.

8. Preparation of Reagents

8.1 Soap Solution.

8.1.1 Dissolve 50 g soap in 1 L water at 45°C .

8.2 Terasil Yellow 2GE 200% Dispersion.

8.2.1 Dispersion: 2.45 g dye into 1000 mL (see 8.6).

8.2.2 Dilution: 20 mL dispersion into 1000 mL

8.2.3 Test Solution for 0.00049 g/L Terasil Yellow 2GE 200%: 10 mL from first dilution and 100 mL soap solution into 1000 mL (see 8.7).

8.3 Irgalan Orange RL-KWL 250% Solution.

8.3.1 Solution: 1.10 g dye into 1000 mL (see 8.6).

8.3.2 Test Solution for 0.011 g/L Irgalan Orange RL-KWL 250%: 10 mL solution and 100 mL soap solution into 1000 mL (see 8.7).

8.4 Solophenyl Blue GL 250% Solution.

8.4.1 Solution: 0.775 g/L dye into 1000 mL (see 8.6).

8.4.2 Dilution: 20 mL into 1000 mL.

8.4.3 Test Solution for 0.000155 g/L Solophenyl Blue GL 250%: 10 mL from first dilution and 100 mL soap solution into 1000 mL (see 8.7).

8.5 Terasil Navy Blue BGLN 200% Dispersion.

8.5.1 Dispersion: 2.4 g dye into 1000 mL (see 8.6).

8.5.2 Test Solution for 0.024 g/L Terasil Navy Blue BGLN 200%: 10 mL dispersion and 100 mL soap solution into 1000 mL (see 8.7).

8.6 Original Dispersion or Solution. Disperse or dissolve a specified quantity of dye in a 200 mL beaker. Using a funnel, transfer it into a 1 L volumetric flask. Using a spray bottle, spray some water around the sides and to the bottom of the beaker and add it to the flask. Repeat until all the dye is transferred. Fill the flask about $3/4$ full with water, close it with a stopper, tip it upside down several times to ensure complete dispersion or solution and fill the flask to the meniscus. Trans-

fer the liquid into a 1 L Erlenmeyer flask and close it with a stopper and mark 'Original Dye Solution.'

8.7 Test Solution. To prepare the test solution for the orange and navy dyes, shake the Erlenmeyer flask containing the 'Original Dye Solution' to ensure a homogeneous dispersion or solution. Using a volumetric pipette, transfer the specified aliquot into a volumetric flask. To avoid excess foaming slowly add 100 mL soap solution and water to fill the flask to the meniscus. Transfer the liquid to a 1 L Erlenmeyer flask, close and mark the flask with 'Test Solution.'

8.7.1 The yellow and blue dyes require an additional dilution prior to making the 'Test Solution.' Shake the Erlenmeyer flask containing the 'Original Dye Solution' to ensure a homogeneous dispersion or solution and transfer the specified aliquot into a 1 L volumetric flask. Dilute with water to the meniscus. Transfer the liquid to a 1 L Erlenmeyer flask, close and mark the flask 'Dilution.' To prepare the 'Test Solution' transfer the specified aliquot into a 1 L volumetric flask. To avoid excess foaming, slowly add 100 mL soap solution and water to fill the flask to the meniscus. Transfer the liquid to a 1 L Erlenmeyer flask, close and mark the flask with 'Test Solution.'

9. Preparation of Canisters

9.1 Rinse canisters to be used with acetone and then with water.

9.2 Immerse lids and seals in a small beaker with acetone for 2 min, rinse with water.

10. Pre-Wetting Specimens

10.1 Wet out the specimens in 1 L water at 50°C for 10 min.

10.2 Rinse the specimens in cold water.

10.3 Squeeze the specimens between blotting paper, or with a wringer to approximately 80% wet pickup.

11. Procedure

11.1 It is essential to attain a level staining of the respective fibers. Evaluations are conducted by colorimetric measurements to eliminate objectivity from visual evaluations. To ensure reproducibility it is necessary to adhere closely to the testing protocol.

11.2 In each of the four canisters, add 300 mL of one of the test solutions.

11.3 Check the pH of the test solution. This should be 9.5-10.

11.4 Enter a control specimen and a specimen under test in a canister and immediately stir for 5-10 s.

11.5 Clamp the covers on the canisters with a Teflon gasket inserted between the neoprene gasket and the top of each canister to prevent contamination.

11.6 Repeat this for the other three canisters.

11.7 Load the canisters as rapidly as possible into the Launder-Ometer or similar device.

11.7.1 If an operator is conducting the tests without an assistant, it is recommended that only two treatment baths (canisters) be prepared and run at one time.

11.8 Start the test at $20 \pm 2^\circ\text{C}$, raise the temperature to $50 \pm 2^\circ\text{C}$ in 20 min and continue at this temperature for 45 min.

11.9 Stop the machine, remove the canisters and place the specimens separately by color in 500 mL beakers. Rinse the specimens with cold water for 2 min. Repeat the rinse with fresh water for an additional 2 min.

11.10 Place the specimens flat on blotting paper and dry in an oven at 50-60°C and condition at $65 \pm 2\%$ RH and $21 \pm 1^\circ\text{C}$ for a minimum of 4 h prior to evaluation.

12. Evaluation

12.1 Fold the specimens to form two layers of the strip to be measured. Place the specimen on the instrument with the weave at a 45° angle. Take two measurements, each at a different place, rotate the

specimen 90° and take two additional measurements, each at a different place.

12.2 Obtain the CIELAB L^* , a^* , b^* , h_{ab} values for the following components:

12.2.1 Secondary acetate for the specimens treated with the yellow dye.

12.2.2 Polyamide for the specimens treated with the orange dye.

12.2.3 Cotton for the specimens treated with the blue dye.

12.2.4 Polyester and polyamide for the specimens treated with the navy dye.

12.2.5 The secondary acetate, polyamide, polyester and cotton for the untreated control multifiber fabric and for the untreated multifiber fabric under test (the values should be practically identical).

13. Calculations

13.1 The ΔE^*_{ab} values are calculated, using the formulae in Clause 4.2.1 of AATCC Test method 173, CMC: Calculation of Small Color Differences for Acceptability. The staining scale ratings (SSR values) are calculated (see Table I) using the formulae in Clauses 6.4 and 6.5 in ISO 105-A04.

13.2 The staining scale ratings for the control multifiber fabric and of the multifiber fabric under test are based on the respective CIELAB values from the appropriate fibers of the tested versus the original specimens.

13.3 If the software does not give the SSR values, the calculations may be made with a hand-held calculator. However, it is more efficient to enter the formulas in an Excel template. (Table I)

13.4 Enter the formulas into the template in cells L3, M3, N3, and O3, exactly as shown in Table II, starting with the equal sign.

13.5 Copy the CIELAB values from the instrument's software into the appropriate cells of the template.

13.6 The adjacent multifiber fabric under test is acceptable for its staining properties when the SSR values are less than 4.00 and greater than 3.00 (see 15.5).

Table I. Excel Template for the Calculation of Staining Scale Rating

	A	B	C	D	E	F	G	H	I	J	K	L	M	N	O
1				Specimen Under Test				Untreated Specimens				Calculated Values			
2	Dyes	Fibers	MF Type	L^*_s	a^*_s	b^*_s	h^*_s	L^*_u	a^*_u	b^*_u	h^*_u	ΔL^*	ΔE^*	ΔE_{ab}	SSR
3	Yellow	DIA	Control												
4			Test												
5	Orange	PA	Control												
6			Test												
7	Blue	CO	Control												
8			Test												
9	Navy	PES	Control												
10			Test												
11		PA	Control												
12			Test												

Table II. Staining Scale Ratings Formulae

Cell L3	DL*	=D3-H3
Cell M3	DE*	=SQRT(L3 ² +(E3-I3) ² +(F3-J3) ²)
Cell N3	DE _{GS}	=M3-0.4*SQRT(M3 ² -L3 ²)
Cell O3	SSR	=IF(6.1-1.45*LN(N3)<4,6.1-1.45*LN(3),5-0.23*N3)

14. Report

14.1 The report should contain, as a minimum, the following information: The Stain Scale Rating [(SSR) value(s)] for both the control specimen as well as the specimen under evaluation for each dyestuff.

14.2 The number and date of this procedure; i.e., AATCC EP #.

14.3 All details necessary for the identification of the sample(s) tested.

15. Notes

15.1 The Launder-Ometer (a registered trademark of Atlas Electric Devices), is available with accessories from SDL Atlas L.L.C., 1813A Associate Lane, Charlotte NC 28217; tel: 704/329-0911; fax: 704/329-0914; e-mail:

info@sdlatlas.com.

15.2 Teflon is a registered trademark of the DuPont Co., Wilmington DE 19898.

15.3 Available from AATCC, P.O. Box 12215, Research Triangle Park NC 27709; tel: 919/549-8141; fax: 919/549-8933; e-mail: orders@aatcc.org.

15.4 ISO 105-C02 Colour fastness to Washing: Test 2 and ISO 105-A04 Method for the Instrumental Assessment of the degree of staining of adjacent fabrics, may be obtained from ANSI, 11 West 42nd St., New York NY 10036; tel: 212/302-1286; fax: 212/398-0023, or ISO.

15.5 Specifying SSR values allows for a tighter tolerance for acceptability than would be possible with conventional Gray Scales ratings.

15.6 A fabric known to meet the staining specifications.

Special Equipment and Materials Used in AATCC Test Methods

It is the policy of AATCC to encourage the development of specialized testing apparatus and materials, not specifically offered by AATCC, for performing the test methods of the Association. Organizations, other than AATCC, wishing to have their materials cited in AATCC test methods shall have the responsibility for their products meeting the specifications established by AATCC and for making available to the Association copies of supporting quality control data. The Association does not test, certify, or guarantee that any testing apparatus or materials conform to specifications or standards.

<i>Item</i>	<i>Source</i>	<i>Item</i>	<i>Source</i>
AATCC Chromatic Transference Scale (for various colorfastness tests)		2003 AATCC Standard Reference Liquid Detergent WOB (Method 124)	A
9-Step Chromatic Transference Scale	A	Bleach Activator (Method 190)	A
AATCC Gray Scale Viewing Stand (various colorfastness tests)	A	Sodium Perborate Monohydrate (Method 190)	A
AATCC Perspiration Tester (Methods 15, 106, 107) Test Rack	C	Dispersibility of Disperse Dyes: Filter Test Filter Residue Scale (Method 146)	A
Weight	C	Stainless Steel Ring (Method 146)	A
AATCC Standard Sandals (Method 134)	A	Drycleaning Cylinder (Method 162)	D
AATCC Static Protected and Static Unprotected Carpet (set of 2) (Method 134)	A	Drycleaning Colorfastness (Method 132) Stainless Steel Discs, per doz.	C
AATCC Wrinkle Tester (Method 128)	A	Cotton Twill Cloth, Undyed (available by the yard or as ready-cut pieces)	B
Accelerator, Model AB-7 (Method 93)	C	Dust Generating Device (Method 184)	R
Acrylic Static Control Carpet (Method 134)	A	Dye Dusting Test Apparatus (Method 170)	A
Ballast Fabric (Methods 88B, 88C, 96, 124, 130, 135, 142, 143, 150, 172, 188, 191)	B,E	Dye Dusting Paper Collar (Method 170)	A
Barré Scales (set of 9) (Method 178)	A	Dye Dusting Photographic Rating Scale (Method 170)	A
Basic Dyes (Method 141)	A	Dynamic Absorption Tester complete with jar (Method 70)	C
Blotting Paper, White AATCC Textile (Methods 8, 35, 42, 70), 20 × 40 in.—211/500		Stainless Steel Jar	C,D
1/4 ream (125 sheets) or more, per cwt	A	Electrostatic Clinging of Fabrics (Method 115) Kit including Metal Test Plate, Grounding Plate, Wood Rubbing Block and Urethane Foam	A
(Paper can be ordered in 10 × 10, 6 × 9 or 6 × 6-inch sizes at an additional charge)		Rubbing Nylon Fabric No. 361	B
No shipment made of less than 1/4 ream		Rubbing Polyester Fabric No. 767	B
Chlorine Test Control Fabric 162; 50 × 105 cm (Method 162)	A	Staticmaster Ionizing Unit No. 2U500	L
Chromatic Transference Scale (for various colorfastness tests)		Fading Apparatus	
9-Step Chromatic Transference Scale	A	Carbon-Arc Lamp (Method 16)	C
Conditioning Racks, Drawings (Methods 96, 99, 135).	A	Outdoor Exposure Rack (Method 16)	C
Cotton Fabric No. 400; 80 × 80 print cloth (carded yarns) 44 in. wide, desized and bleached; no bluing, optical bleach or finishing material present	B	UV Light (Method 186)	C,O,P
Cotton Sateen, Greige (Method 27)	B	Xenon-Arc Lamp (Method 16)	C
Cotton Skeins, Greige, 5-gram (Methods 17, 43, 89)	B,E	Filter Residue Scale (Methods 146, 166)	A
Crease Appearance Replicas (Method 88C), set of 5 ..	A	Flock Rating Chart (Method 142)	A
Crockmeter, Model CM-1 (Methods 8, 165)	C	Gas Fading Standard (Methods 23, 164) 20 yds of dyed ribbon and a swatch of the Standard of Fading	B
Crockmeter with Counter (Methods 8, 165)	C	Gas Fading Test Chamber (Method 23) small scale, blueprint only	A
Crockmeter, Motorized, with shutdown Counter (Method 8)	C	Glassine Paper, 150 ft × 12 in., per roll (Method 130) ..	A
Crockmeter, Rotary Vertical (Method 116)	C	Gray Scale for Color Change including Intermediate Steps (all colorfastness tests)	A
Crockmeter Cloth (Methods 8, 116, 165), 80 × 84 (combed yarns) 44 in. wide, desized and bleached; no bluing, optical bleach or finishing material present	B,E	Gray Scale for Staining (various colorfastness methods)	A
Detergent		Hydrostatic Head Tester (Method 127)	N
1993 AATCC Standard Reference Detergent (Methods 88B, 88C, 96, 124, 130, 135, 142, 143, 150, 179) per 25 lb.	A	Hydrostatic Pressure Tester (Method 127)	M
1993 AATCC Standard Reference Detergent WOB (Methods 61, 167, 172, 188, 190) per 25 lb	A	Impact Penetration (Method 42) Spray Head	A
AATCC Detergent 171 (Method 171)	A	Clip and Plate Unit	A
2003 AATCC Standard Reference Liquid Detergent (Method 124)	A	Complete Apparatus Type I Tester (includes Spray Test Apparatus)	A
		Complete Apparatus Type II Tester	A
		Jute Underlay (Method 134), (set of 2)	A
		Launder-Ometer (Methods 28, 61, 86, 132, 151, 190) ..	C
		Stainless Steel Cylinder, 3 × 5 in., each	C
		Stainless Steel Cylinder, 3.5 × 8 in., each	C
		Stainless Steel Balls, 0.25 in., per 250	C

<i>Item</i>	<i>Source</i>	<i>Item</i>	<i>Source</i>
Lightfastness Standards L2, L4, L5, L6, L8 (Method 16)		Spray Test Apparatus, complete (Method 22).....	A
Each Standard, 50 × 75 cm.....	A	Spray Test Unit: Hoop and Rating Chart	
Standard of Fading for Lightfastness		(Method 22).....	A
Standard L2.....	A	Stain Release Replica.....	A
Standard of Fading for Lightfastness		Stain Resistance: Pile Floor Coverings (Method 175) .	A
Standard L4.....	A	AATCC Red 40 Stain Scale.....	A
Microscopy Supplies (Method 20).....	A	FD&C Red 40 (50 g).....	A
Microscopy Cross-section Kit.....	A	AATCC Stain Cup and Ring (2 sets).....	A
Yarn Holder and Fabric Holder.....	A	Standard Sandals (Method 134).....	A
Razor Blades, 1 Box of 100.....	A	Static Jute Underlay (Method 134), (set of 2).....	A
Cross-section Slides, 50.....	A	Static Protected and Static Unprotected Carpet	
Black and White Filler Yarn.....	A	(Method 134), (set of 2).....	A
Cashmere/Wool Standard Reference Fibers.....	A	Tiles for Rug Back Staining (Method 137)	
Moth Test Cloth, worsted (Methods 24, 28).....	B	3 in. × 3 in., per 40 tiles.....	A
Multifiber Test Fabric No. 1, FB containing spun		Uniformity Reference Scales (Barré) (Method 178),	
acetate, bleached cotton, spun nylon 6,6,		(set of 9).....	A
spun silk, spun viscose, worsted wool		Washer and Dryer (various laundering methods).....	A
(Methods 61, 101, 106, 107).....	B,E	Crease Appearance Replicas (Method 88C),	
Multifiber Test Fabric No. 10, FA containing spun		(set of 5).....	A
acetate, bleached cotton, spun nylon 6,6,		Wringer, Motorized Laboratory (Methods 8, 15, 70,	
spun Dacron 54, spun Orlon 75, worsted wool		92, 107, 137, 138).....	C
(Methods 15, 61, 106, 107).....	B,E	Wrinkle Recovery Plastic Replicas (Method 128),	
Multifiber Test Fabric No. 10A, FAA containing same		(set of 5).....	A
fibers as No. 10 but stripes are double wide		Wrinkle Tester (Method 128).....	A
(Methods 61, 117).....	B,E	Xenon Reference Fabric (Method 16).....	A
Ozone Fading Control Standard No. 109 and		XRF-1, Standard of Fading (Method 16).....	A
Standard of Fading No. 109 (Method 109).....	B		
Ozone Fading Control No. 129 and Standard			
of Fading No. 129 (Method 129).....	A		
Ozone Test Chamber Blueprint (Method 129).....	A		
Perspiration Tester, AATCC (Methods 15, 106, 107)			
Test Rack.....	C		
Weight.....	C		
Perspirometer (Method 15).....	H		
Photographs for Seams, Single and Double Needle			
(Method 88B).....	A		
Pleating Test Specimen Holder (Method 131).....	C		
Quickwash Plus System (Method 187).....	C		
Rain Tester (Method 35).....	A		
Ring, Stainless Steel (Method 146).....	A		
Scorch Tester, Model SO-3B (Methods 92, 114).....	C		
Shrinkage Scale and Marking Pens (Methods 96,			
99, 135, 150).....	A		
Shrinkage Scale (Methods 96, 99, 135, 150).....	A		
Smoothness Appearance Replicas (Method 124),			
(set of 6).....	A		
Soap, Neutral Granular (Methods 28, 89, 99)			
12 lb.....			
Soil Release test (Method 130)			
5 lb. weight.....	A		
Glassine Paper, 150 ft. × 12 in., per roll.....	A		
Sole material: Neolite, approx. 14 × 14 in.			
(Method 134).....	A		
Spray Nozzle (Method 22).....	A		

SOURCES OF SUPPLY

- A AATCC, P.O. Box 12215, Research Triangle Park NC 27709; telephone 919/549-8141 Ext. 226; fax: 919/549-8933; e-mail: orders@aatcc.org. Contact AATCC for pricing and shipping information or see our website at www.aatcc.org.
- B Testfabrics Inc., P.O. Box 26, 415 Delaware St., W. Pittston PA 18643; telephone 570/603-0432; fax: 570/603-0433; e-mail: testfabric@aol.com.
- C SDL Atlas L.L.C., 1813A Associate Lane, Charlotte NC 28217; tel: 704/329-0911; fax: 704/329-0914; e-mail: info@sdlatlas.com.
- D SGS U.S. Testing Co. Inc., Instrument Marketing Div., 291 Fairfield Ave., Fairfield NJ 07004; telephone 973/575-5252 or 800/777-8378.
- E Textile Innovators Corp., div. of SDL Atlas L.L.C., P.O. Box 8, 101 Forest St., Windsor NC; tel: 252/794-9703; fax: 252/794-9704; e-mail: tic@sdlatlas.com.
- H The Orange Machine & Mfg. Co., 1503 Bay Ave., Point Pleasant NJ 08742; telephone 908/295-2262.
- L NRD, Inc., 2937 Alt. Blvd., North, Grand Island NY 14072; telephone 716/773-7634.
- M Alfred Suter Co., P.O. Box 350, Ramsey NJ 07446-0350; telephone 201/818-0113; fax: 201/818-0654.
- N Advanced Testing Instruments Corp., 316D Business Parkway, Greer SC 29651-7119; telephone 864/989-0566; fax: 864/989-0567.
- O Q-Panel Lab Products, 26200 First St., Cleveland OH 44145; telephone 440/835-8700; fax: 440/835-8738.
- P Suga Test Instruments, 5-4-14 Shinjuku-Ku, Tokyo 160, Japan; telephone (3) 354 5248.
- R Roaches International, Upper Hulme, Leek, Staffordshire, United Kingdom; telephone 44 01538 300425; fax 44 01538 300364.

1993 AATCC Standard Reference Detergent and Laundry Detergents in General

Developed in 1995 by AATCC Committee RA88; revised 1981/1982, 1991, 1998 (with title change), 2005.

1. Background/History

1.1 AATCC Standard Reference Detergent 124 was chosen to represent the type of washing product used for home laundering in the 1960s. The composition of this particular detergent, when adopted, was, except for suds level, typical of commercial laundry products used by most persons for home laundering. A variant formulation, AATCC Standard Reference Detergent WOB (without optical brightener), was the same but without a fluorescent whitener for use in colorfastness to laundering tests.¹ However, the proliferation of detergent formula variations and even of new types of detergent since 1970 have made Standard Reference Detergents 124 and WOB obsolete. The following paragraphs provide some perspective concerning the current laundry detergent situation and the current use of 1993 AATCC Standard Reference Detergent.

1.2 From the early 1950s until 1970 there was little change in U.S. laundry detergents in regard to product form and general composition. Practically all of the detergent products intended for clothes washing were phosphate-built synthetic detergents varying primarily in kind of surfactant (anionic or nonionic), suds level and, to a lesser extent, in phosphate level. At that time almost all industry detergent products contained phosphates in amounts corresponding to 12-14% calculated as elemental phosphorus. Most brands were in powder form but there were also some heavy duty liquids. Other types, collectively comprising less than 10% market share, were detergent pellets, a few brands of true soap products and unbuilt detergent powders (e.g., formulated with surfactant and inert filler).

1.3 A growing ecological concern with U.S. water quality during the late 1960s resulted in considerable social and political pressure for eliminating the use of phosphate in detergent products. By the end of the decade, vast changes in deter-

gent formulation began which, at this writing, have not yet ceased.

2. Current and Future Trends in the Detergent Industry

2.1 In contrast to the period when high phosphate, low phosphate and nonphosphate detergents were sold simultaneously, the marketed laundry detergents today include: (a) nonphosphate carbonate-built powders, some of which may contain aluminosilicates (zeolites); (b) citrate-built heavy duty liquids; and (c) nonbuilt heavy duty liquids. Thus, the national brands are divided into three basic categories all of which are nonphosphate. Most detergents contain, besides surfactants and builders, ingredients to reduce caking (powders), fluorescent whiteners, antiredeposition agents, colorants, perfumes, suds control ingredients, and anticorrosives. Some of them may also contain enzymes, bleaches, bleach alternative ingredients and softeners (now rare). The market share for liquids vs. powders in the late 90s is approximately a 49/51 split with liquids showing a steady rise. This trend is expected to continue.

2.2 In the longer term, the detergent market will continue to change due to: availability and cost of materials, product costs, energy conservation, and environmental concerns (in both end use and manufacturing). Packaging and product dosage will also constantly change. Consumers will continue to use laundry aids such as chlorine and non-chlorine bleaches, laundry boosters, pretreating/prespotting agents, softeners (both rinse cycle and dryer types), borax, bluing, etc. The laundry products market will constantly undergo subtle changes in all areas beyond the year 2000.

3. Rationale for Using 1993 AATCC Standard Reference Detergent

3.1 With this background and especially the environmental concerns with the use of phosphates, it had become apparent that a change in the formulation of the AATCC Standard Reference Detergent was needed. Because all existing industry test data relative to effects of home laundering on commercial textiles are based on Standard Reference Detergents 124 and WOB, comparisons were made using a concentrated carbonate built pow-

der with no enzymes or phosphates. The concentrated carbonate built powder formulation is representative of the types of products on the market in 1993. Enzymes were not added to the formula due to possible changes of enzyme strength over the storage life of the product.

3.2 Laboratory comparisons of Standard Reference Detergents 124 and WOB and the concentrated carbonate built powders both with and without optical brighteners indicated that no significant differences between the detergent formulations were seen except for oily stain removal. The new concentrated carbonate built formulas, named 1993 AATCC Standard Reference Detergent and 1993 AATCC Standard Reference Detergent WOB, were not as effective in removal of oily stains. This has been noted in the applicable test methods. Laboratory comparisons between 1993 AATCC Standard Reference Detergents and currently marketed products would likely show differences in washing performance. However, comparison among currently marketed products could also show differences of similar or even greater magnitude.

3.3 One of the factors leading to possible differences between results using the 1993 AATCC Standard Reference Detergents and current detergent products is water hardness. In hard water situations, the 1993 AATCC Standard Reference Detergents may give better soil removal results because they are more effective across a broader range of hardness than most commercially available products.

3.4 Users of standard test methods involving laundering need to be aware that other Standard Reference Detergents are used in various ISO test methods. These detergents are specified in methods designed for home laundering equipment sold in other parts of the world.

4. Rationale for Use of Reference Detergents in Laboratory Testing

4.1 Many fabric attributes critical to consumer use and acceptability, such as dimensional change, surface or smoothness appearance, colorfastness, soil release, and flammability resistance performance are influenced by the manner in which textile products are laundered. The textile industry has adopted standard detergents and laundering conditions to allow for the prediction of the acceptability of textile prod-

¹ Absorption of fluorescent whitener on a textile material changes its visual appearance and consequently interferes with the evaluation of color change and/or staining.

ucts to judge the performance of their products. The standard detergents have been designed to represent a cross section of market detergents.

4.2 The use of locally purchased national brands of detergents in testing labs is a fairly common practice. This practice has been driven by several factors: a) care labeling considerations, b) inaccurate assumption that the same detergent brand has the same composition from location to location and from one year to the next one, c) the convenience of buying locally, and d)

price. The use of “off the shelf” detergents in laboratory testing adds an element of variability that use of standard test methods and detergents intends to control. The percentage of optical brightener or fluorescent brightener agents has a definite effect on colorfastness evaluations. The amount of optical brightener or fluorescent brightening agents is known to vary within a single brand of detergent sold for consumer use.

4.3 Detergent producers have developed detergents with other cleaning components

such as non-chlorine color safe bleach systems. AATCC now has full-scale (washing machine) methods and accelerated standard procedure for determination of colorfastness using such products. They are AATCC Method 172, Colorfastness to Non-Chlorine Bleach in Home Laundering, and AATCC Method 190, Colorfastness to Home Laundering with Activated Oxygen Bleach Detergent: Accelerated.

4.4 It should be noted that different standard laundering equipment and detergents are used in Europe and Asia.

2003 AATCC Standard Reference Liquid Laundry Detergent

Developed in 2003 by AATCC Committee RA88; revised 2005.

1. Background on Standard Reference Detergents

1.1 The AATCC and other testing and development groups have used standard reference detergents since the 1960s. AATCC Standard Reference Detergent 124 and AATCC Standard Reference Detergent WOB (without optical brightener) were the first formulations adopted by the AATCC to represent typical home laundry products of that era, primarily phosphate-built powder detergents.

1.2 During the 1970s, due to environmental pressures to eliminate the use of phosphates in detergents, a major shift in the composition of marketed laundry detergents began.

1.3 By the 1980s, the composition of the detergent market had moved from being predominantly phosphate-built, powder detergents to ~50% carbonate-built powder detergents and ~50% citrate-built heavy-duty liquid detergents.

1.4 Consequently, in 1993 the AATCC adopted a new standard reference detergent that was more representative of powder laundry products of the 1990s.

2. Trends in the Laundry Detergent Industry

2.1 Over the past decade, powder detergent sales have fallen while liquid detergent sales have experienced steady growth. In the mid 1990s, the powder and liquid detergent split was ~50/50. In 2001, the market split was closer to 40/60 in favor of liquid laundry detergents, with additional growth expected in that category. Other product forms (tablets, pouches, bags) make up a small percentage of the market. In the U.S., there has been increased activity with the tablet and pouch forms; their impact on the overall detergent market is to be determined.

2.2 The detergent market will continue to evolve as the demands of the consumer and chemical industries change. Detergents of the future will be impacted by many factors, including environmental concerns, conservation efforts, chemical availability, raw material costs, performance benefits, consumer needs, etc. There is therefore a need to ensure that reference detergents are reflective of marketed products and should be updated after major shifts in the detergent industry are noted.

3. Comparison of Powder and Liquid Laundry Detergents

3.1 Both powder and liquid laundry detergents are primarily composed of surfactants and builders (except non-built liquid detergents which contain primarily surfactants). They both also contain processing or delivery aids for product stability and can contain many optional ingredients to provide performance or aesthetic benefits, such as fluorescent brighteners, enzymes, bleaches, anti-redeposition agents, fiber and dye protective agents, perfumes, suds control agents, etc.

3.2 A key difference between powder and liquid laundry detergents is their builder system. Powder detergents are typically better built than liquid laundry detergents, have a carbonate-builder system, often contain aluminosilicates (zeolites) for added builder capacity, and perform optimally at higher pHs (pH=10). Heavy-duty liquid laundry detergents are typically citrate-built and perform optimally at lower pHs (pH=8.5).

4. Rationale for 2003 AATCC Standard Reference Liquid Laundry Detergent

4.1 Based on market share, the inclusion of a reference liquid laundry detergent for standard and developmental testing in the textile area is long overdue. For the past 10 years, liquid laundry detergents have made up at least ~50% of the U.S. detergent market and now make up nearly 60%. To be able to test and develop products that are relevant to the current laundry market, a reference liquid laundry detergent is needed.

4.2 Although powder and liquid detergents are designed to provide cleaning and stain removal, they achieve these objectives differently. A key difference is the pH regime in which the two product forms operate. Powder detergents perform optimally at higher pHs (pH=10). This higher pH is a relatively hostile environment for stains making powder detergents very effective at stain removal; however, the higher pH also tends to negatively impact fibers and dyes. Over the years, technologies have been developed to deliver benefits under high pH conditions and powder detergents have been able to overcome many of their initial disadvantages.

4.3 Liquid detergents perform optimally at lower pHs (pH=8.5). Because this pH is closer to neutrality, liquid laundry detergents tend to be less harsh on

fabrics and dyes. Over the years, technologies have been developed to help liquid laundry detergents deliver stronger cleaning benefits while maintaining the less harsh fabric and dye profiles. Since there are significant formulation differences between powder and liquid laundry detergents, different reference detergents are needed to fairly represent them.

4.4 The performance of the 2003 AATCC Standard Reference Liquid Laundry Detergent was compared to five nationally marketed products in the areas of cleaning (stain removal), color care, and fabric appearance. The standard reference liquid detergent is representative of the U.S. market.

4.4.1 Overall and on individual stains, the cleaning (stain removal) profile of the 2003 AATCC Standard Reference Liquid Laundry Detergent falls within the performance of the five nationally marketed liquid laundry detergents. ASTM Method D 4265-98 (Volume 15.04) was used under full-scale, median wash conditions (wash water at 90°F, 6 gpg hardness, 12 min wash cycle). Stain removal was assessed instrumentally and reported in SRI (stain removal index).

4.4.2 The colorfastness to washing of the 2003 AATCC Standard Reference Liquid Laundry Detergent is comparable to a nationally marketed liquid laundry detergent. AATCC Method 135, Dimensional Changes of Fabrics after Home Laundering, was used under full-scale, median wash conditions and taken to 30 wash cycles. Fabrics were assessed instrumentally (ΔE_{CIE}) and visually (Gray Scale). Using either assessment scale, the relative ranking of color change was similar between the 2003 AATCC Standard Reference Liquid Laundry Detergent and the nationally marketed product. Due to the very large size of this testing, the reference detergent was compared to only one nationally marketed product that is similar in composition.

4.4.3 In conjunction with the colorfastness testing, the impact of the 2003 AATCC Standard Reference Liquid Laundry Detergent on fabric appearance was also assessed and found to be similar to a nationally marketed liquid laundry detergent. AATCC Method 135 was used under full-scale, median wash conditions and taken to 30 wash cycles. Fabrics were assessed visually (color, pilling/abrasion).

4.4.4 The 2003 AATCC Standard Reference Liquid Laundry Detergent was also compared to the powder 1993 AATCC Standard Reference Detergent

for shape retention and color care profile. The performance results for these standards fall within their general market counterparts.

4.5 AATCC technical committees will incorporate the standard reference liquid detergent into appropriate test methods as they are developed and come up for reaffirmation.

4.6 This 2003 Liquid Standard is available without brighteners (referred to as "2003 AATCC Standard Reference Liquid Laundry Detergent WOB") and with brighteners (referred to as "2003 AATCC Standard Reference Liquid Laundry Detergent").

5. Rationale for Use of Reference Detergents in Laboratory Testing

5.1 Many fabric attributes critical to consumer use and acceptability, such as dimensional change, surface or smoothness

appearance, colorfastness, soil release, and flammability resistance performance are influenced by the manner in which textile products are laundered. The textile industry has adopted standard detergents and laundering conditions to allow for the prediction of the acceptability of textile products to judge the performance of their products. The standard detergents have been designed to represent a cross section of market detergents.

5.2 The use of locally purchased national brands of detergents in testing labs is a fairly common practice. This practice has been driven by several factors: a) care labeling considerations, b) inaccurate assumption that the same detergent brand has the same composition from location to location and from one year to the next one, c) the convenience of buying locally, and d) price. The use of "off the shelf" detergents in laboratory testing adds an element of variability that use of standard test

methods and detergents intends to control. The percentage of optical brightener or fluorescent brightener agents has a definite effect on colorfastness evaluations. The amount of optical brightener or fluorescent brightening agents is known to vary within a single brand of detergent sold for consumer use.

5.3 Detergent producers have developed detergents with other cleaning components such as non-chlorine color safe bleach systems. AATCC now has full-scale (washing machine) methods and accelerated standard procedure for determination of colorfastness using such products. They are AATCC Method 172, Colorfastness to Non-Chlorine Bleach in Home Laundering, and AATCC Method 190, Colorfastness to Home Laundering with Activated Oxygen Bleach Detergent: Accelerated.

5.4 It should be noted that different standard laundering equipment and detergents are used in Europe and Asia.

Standardization of Home Laundry Test Conditions

Developed in 1984 by AATCC Committee RA88; revised 1986, 1992, 1995, 2003, 2005.

Many AATCC test methods include procedures for laundering and/or restoring fabrics or garments after laundering. In the past, these methods have been developed independently of each other, with little consultation between test method committees. This had led to a wide variation in test conditions between methods, and even when the same condition was specified in two methods there might be differences in nomenclature or designation of the condition. The situation was further complicated by the fact that some of the test conditions; e.g., wash water temperature, did not adequately reflect actual consumer practice. This was in large part due to significant changes in consumer practices in the past several years as a result of energy conservation measures and changing lifestyles.

In order to establish a consistent set of test conditions for all test methods involving home laundering, an AATCC committee was established. Based on the input of a number of AATCC and ASTM committees and a survey of actual consumer practice, a set of guidelines was developed for the standardization of laundering, drying and restoration terminology in AATCC test methods. These guidelines have been approved by all AATCC committees involved in laundering test methods and are now presented in Tables I-IV for the guidance of committees developing test methods utilizing laundry procedures. Energy-efficient washing machines sold after 1989 and dryers sold after 1983 have standard settings which differ from those of older models, as noted in Table II and Table IV. Table V provides the Federal Trade Commission (FTC) wash temperatures for information purposes only. FTC drying conditions are the same.

It should be noted that the designated wash temperatures are at the upper limit of each temperature range, as this is the critical area for appearance retention test methods. In actual practice, the cold water temperature, $27 \pm 3^\circ\text{C}$ ($80 \pm 5^\circ\text{F}$), is probably higher than a significant number of consumers can achieve, particularly in the winter. It is for this reason that the very cold temperature, 16°C (60°F), was added. It should be emphasized that it is not necessary that all test conditions be included in any test method. However, if these conditions are used, the numerical/alphabetic designations and terminology shown in the tables should be used.

Table I—Machine Wash Conditions

Designation	Wash Temperature	Rinse Temperature
I	Very Cold: $16 \pm 3^\circ\text{C}$ ($60 \pm 5^\circ\text{F}$)	$<18^\circ\text{C}$ (65°F)
II	Cold: $27 \pm 3^\circ\text{C}$ ($80 \pm 5^\circ\text{F}$)	$<29^\circ\text{C}$ (85°F)
III	Warm: $41 \pm 3^\circ\text{C}$ ($105 \pm 5^\circ\text{F}$)	$<29^\circ\text{C}$ (85°F)
IV	Hot: $49 \pm 3^\circ\text{C}$ ($120 \pm 5^\circ\text{F}$)	$<29^\circ\text{C}$ (85°F)
V	Very Hot: $60 \pm 3^\circ\text{C}$ ($140 \pm 5^\circ\text{F}$)	$<29^\circ\text{C}$ (85°F)

Table IIA—Washing Machine Setting Conditions without Load 2000⁵

Cycle ¹	Normal ¹	Permanent Press ¹	Delicate ¹
Water Level Medium ²	18 ± 1 gal	18 ± 1 gal	18 ± 1 gal
Agitation Speed	179 ± 2 spm ³	179 ± 2 spm	119 ± 2 spm
Washing Time	12 min	10 min	8 min
Spin Speed	645 ± 15 rpm ⁴	430 ± 15 rpm	430 ± 15 rpm
Final Spin Time	6 min	4 min	6 min

Table IIB—Washing Machine Setting Conditions without Load 1992–1999

Cycle ¹	Normal ¹	Permanent Press ¹	Delicate ¹
Water Level Medium ²	18 ± 1 gal	18 ± 1 gal	18 ± 1 gal
Agitation Speed	179 ± 2 spm ³	179 ± 2 spm	119 ± 2 spm
Washing Time	12 min	10 min	8 min
Spin Speed	645 ± 15 rpm ⁴	430 ± 15 rpm	430 ± 15 rpm
Final Spin Time	6 min	4 min	6 min

Table IIC—Washing Machine Setting Conditions without Load 1989–1991

Cycle ¹	Normal ¹	Permanent Press ¹	Delicate ¹
Water Level Medium ²	18 ± 1 gal	18 ± 1 gal	18 ± 1 gal
Agitation Speed	179 ± 2 spm ³	179 ± 2 spm	119 ± 2 spm
Washing Time	12 min	10 min	8 min
Spin Speed	645 ± 15 rpm ⁴	430 ± 15 rpm	430 ± 15 rpm
Final Spin Speed	6 min	4 min	4 min

Table IID—Washing Machine Setting Conditions without Load before 1989

Cycle ¹	Normal ¹	Permanent Press ¹	Delicate ¹
Water Level Medium ²	18 ± 1 gal	18 ± 1 gal	18 ± 1 gal
Agitation Speed	68 ± 2 spm ³	68 ± 2 spm	45 ± 2 spm
Washing Time	12 min	10 min	8 min
Spin Speed	510 ± 15 rpm ⁴	340 ± 15 rpm	340 ± 15 rpm
Final Spin Time	6 min	4 min	4 min

¹ Cycle names vary with machine brand and model. "Normal Cycle" generally corresponds to the cycle that has the highest agitation and spin speed and it is also frequently designated as "Heavy Duty" or "Ultra Clean." "Permanent Press Cycle" generally corresponds to the cycle with the shortest final spin time to minimize wrinkle formation and it is also frequently designated as "Easy Care." "Delicate Cycle" generally corresponds to the cycle with the shortest washing time and it is also frequently designated as "Gentle."

² A water volume of 18 ± 1 gallons is equivalent to 68.1372 ± 3.7854 L. Since 1989, a water volume of 18 gallons is designated for washing medium size loads and it is frequently referred as "medium water level." A volume of 21–22 gallons (equivalent to 79.4934 – 83.2788 L) is designated for washing large size loads and it is frequently referred as "high water level."

³ spm = strokes per minute.

⁴ rpm = revolutions per minute.

⁵ The washers and dryers specifications listed are based upon models that are available in the U.S., specifically, the models at 60 Hz. Many models available outside of the U.S., specifically models at 50 Hz, may have some variations in these conditions. In many models, the wash time is shorter than listed. If this is the case, report the actual time.

Table III—Drying Procedures

Designation	Drying Techniques
A	Tumble
B	Line
C	Drip
D	Screen
E	Flat Bed Press

Table IV—Tumble Drying Conditions¹

Drying Designation	Cycle	Maximum Exhaust Stack Temperature with Loaded Dryer ¹
a	Normal or Permanent Press	65 ± 6°C (150 ± 10°F) [67 ± 6°C (154 ± 10°F) after 1983]
b	Delicate, Synthetic, Low	<60°C (140°F) [<62°C (144°F) after 1983]
Cool Down Time	Normal and Delicate	5 min
	Permanent Press	10 min
	[All	10 min after 1983]

¹ The temperature of dryer exhaust should be measured at the end of the drying cycle before any cool down.

Table V—Federal Trade Commission—Wash Temperature

Cold	Initial water temperature setting same as cold water tap up to 29°C (85°F)
Warm	Initial warm temperature setting 32-43°C (90-110°F)
Hot	Water up to 66°C (150°F)

Note: It is recommended that washing machines used for performing standard testing be calibrated before running a test or at minimum once a year to confirm they are performing as specified. This is particularly important for older models and machines that are three or more years old. Simple procedures can be used to calibrate the machines as follows:

- a) Water Level: Manually, using a graduated metal pail, fill machine with room temperature water until it totals the specified volume (e.g. 18 gal). Vertically, submerge into the water (perpendicularly to its surface), an 18 inch or longer metal ruler until it touches the bottom of the machine drum. Using a permanent ink marker, draw a line on the ruler at the point of contact with the surface of the water. In the future, use the marked ruler to check the volume of water in-taken by the machine (the ruler needs to be submerged at exactly the same point where it was submerged during the initial calibration).
- b) Agitation Speed (spm): To facilitate the counting of the spm during agitation in the wash cycle, tape (use duct tape) one end of a 6 inch metal ruler or rod to the center point on the top of the agitating post of the machine. Tape a small piece of the duct tape at the free end of the metal ruler. Start machine and count the number of strokes per minute in the wash cycle by focusing your eyes on the marked free end of the ruler.
- c) Spin Speed (rpm): Use a tachometer to measure the speed (rpm) of the machine during the spinning process. Follow the operating instructions for the tachometer that is used.

Standard Laboratory Practice for Home Laundering Fabrics Prior to Flammability Testing to Differentiate Between Durable and Non-Durable Finishes

Developed in 1991 by AATCC Committee RA88; editorially revised 1997.

1. Purpose and Scope

1.1 This monograph recommends a standard laboratory practice to determine the effect of five home launderings, with detergent, in combination with other laundering additives, on the flammability performance of fabrics which are being evaluated before sale. It is not intended as a guideline for cleaning those items sold as flame resistant. Many flammability tests and regulations have a laundering requirement either to determine the durability of the flame resistant performance or to establish the flammability classifications of textiles (16 CFR Part 1610) before and after laundering (see 4.1). Some of these tests or regulations incorporate one AATCC procedure or another. Organizations have established different procedures, often not well documented. Hence the need for an AATCC recommended standard laboratory practice which allows the test method to match the potential home care practices of the consumer and to differentiate between durable and nondurable flame resistant fabric treatments.

1.2 This laboratory practice is intended to represent a rigorous home laundering. Consequently, 60°C (140°F) is selected as the laundering temperature and 29°C (85°F) as the rinse temperature (see 4.2). The 1993 AATCC Standard Reference Detergent is the detergent recommended. TIDE, a commonly used detergent, may be used (see 4.3). In case of dispute the affected parties should use 1993 AATCC Standard Reference Detergent. Most other detergents are rather similar with respect to pH and other factors which might affect flammability performance.

1.3 Soap products are known to degrade the flammability performance of some flame resistant fabrics, hence some flame resistant products have a care label recommending against the use of soap in

laundering. Soaps interfere with the flammability performance by leaving a deposit on the fabric and not by removing any durable flame resistant chemical additive. Laundering additives may be incorporated if the parties agree (4.4 and 4.5). Consistent with the rigorous home laundering cycle concept, a drying cycle set on Normal [67°C (154°F) stack temperature] is specified after each home wash cycle.

2. Recommended Practice

2.1 Fill washer with water at 60 ± 3°C (140 ± 5°F). Select a lukewarm rinse setting of 29 ± 3°C (85 ± 5°F) (see 4.6).

2.2 Add detergent (see 4.7).

2.2.1 When using 1993 AATCC Standard Reference Detergent: Add 66 ± 1 g of 1993 AATCC Standard Reference Detergent per wash.

2.2.2 When using TIDE: Add the recommended amount of TIDE detergent specified on the detergent container. Record type and amount of TIDE used.

2.3 Add the fabric(s) to be tested along with ballast load to bring the load weight to 2.7 ± 0.06 kg (6.0 ± 0.13 lbs). Keeping load weight constant is necessary for testing the effects of products such as detergent and laundering additives.

2.4 Set the timer dial on the washer for a Normal or Cotton/Sturdy 12 min cycle, and start the wash cycle.

2.5 Upon completion of the entire cycle, place the load (fabric and ballast) in a home type dryer (see 4.6). Dry at the High setting [67 ± 6°C (154 ± 10°F)] for 45 min and time the cycle. When dryer sheet softeners are being used as the softener type, place the recommended number of sheets in the dryer at this time.

2.6 A total of five home laundering sequences should be run. Five cycles have been shown to differentiate between nondurable and durable fabric flame resistant finishes as well as allow the fabric to come to equilibrium with the fabric softener, bleach and detergent.

3. Additives

3.1 The effects of additives on flammability performance may be evaluated by using this standard practice. Additives should be appropriate for the fabric to be evaluated.

3.1.1 Follow package recommendations for product amount to add and when to add (see 4.8).

3.1.2 Test each additive separately in conjunction with Section 2.

4. Notes

4.1 The Consumer Product Safety Commission regulates clothing and textile flammability under the Flammable Fabrics Act. This voluntary industry standard was mandated as CS191-53 and was codified as 16 CFR 1610.

4.2 A typical hot water temperature in the home is 49°C (120°F).

4.3 TIDE is a registered trademark of Procter & Gamble Co., Cincinnati OH 45217.

4.4 This procedure may be used to evaluate the effect of any home laundering additive on fabric flammability performance and may be used as the basis for home laundering recommendations with regard to such additives. In the event a home laundering recommendation has been made for a flame resistant fabric, regarding either use, or nonuse, of any home laundering additive, that recommendation shall be followed in the application of this standard laboratory practice.

4.5 If a softener is likely to affect the raised surface of a fabric, a softener should be used in this procedure.

4.6 Contact AATCC, P.O. Box 12215, Research Triangle Park NC 27709; tel: 919/549-8141; fax: 919/549-8933; e-mail: orders@aatcc.org, for model number(s) and source(s) of approved washer(s) and dryer(s). Any other washer which is known to give comparable results may be used.

4.7 Overusing detergent can create excess suds in laundering and combine with the fabric softener to form an undesirable residue in the rinse.

4.8 Washing recommendations regarding either use, or nonuse, of any home laundering additives are to be observed in application of this standard laboratory practice.

Nomenclature for Subjective Rating Processes

Adopted in 1951 by AATCC; revised 1957, 1967, 1990 (jurisdiction of AATCC Committee RA93); 1992.

Many textile test methods (e.g., for colorfastness, appearance retention, stain release, wrinkle recovery and disperse dye dispersibility) include a set of reference standards for subjectively rating the characteristic or characteristics under evaluation. The rating process results in an assigned grade. The terms rating and grade are defined as follows:

rating, n.—*in textile testing*, the process for determining or assigning a grade to a material by comparing it to a standard reference scale.

grade, n.—*in textile testing*, the symbol for any step of a multistep standard reference scale for a quality characteristic. Note 1: The grade is assigned to test specimens exhibiting a degree of the quality comparable to that step of the standard. Note 2: Numerical grades assigned to different specimens from a sample or by different observers are commonly averaged.

The number of rating steps or grades within a standard varies as follows:

Nine grades are provided for colorfastness to light when specimens are rated directly with reference to the eight Blue Wool Lightfastness Standards:

Grade	9	Superlative
	8	Outstanding
	7	Excellent
	6	Very Good
	5	Good
	4	Fairly good
	3	Fair
	2	Poor
	1	Very poor

Five grades—usually with intermediate decimal half grades—are provided for most other subjectively rated characteristics ranging from Grade 5, High, to Grade 1, Low. A grade lower than 1 is seldom of interest, but it may be designated Grade 0.

Terms which can be used to express the relative colorfastness or appearance of the grades as determined by the tests are as follows:

• Degree of Alteration in Lightness, Hue and Chroma of Color:¹

Grade	5	Negligible or no change
	4	Slightly changed
	3	Noticeably changed
	2	Considerably changed
	1	Much changed

• Terms for describing Differences in Color:¹

B1 = Bluer

G	= Greener
R	= Redder
Y	= Yellower
L	= Lighter
Da	= Darker
MC	= More Chroma
LC	= Less Chroma

• Degree of Staining:²

Grade	5	Negligible or no staining
	4	Slightly stained
	3	Noticeably stained
	2	Considerably stained
	1	Heavily stained

• Most other properties:³

Grade	5	Excellent
	4	Good
	3	Fair
	2	Poor
	1	Very poor

²Gray Scale for Staining: AATCC Evaluation Procedure 2. AATCC Chromatic Transference Scale: AATCC Evaluation Procedure 3.

³Crease Appearance Replicas: AATCC Methods 88C and 143. Durable Press Replicas: AATCC Methods 124 and 143. Photographs for Seams, Single and Double Needle: AATCC Methods 88C and 143. Dusting Test Scale: AATCC Method 170. Filter Residue Scale: AATCC Test Method 146. Photographs for Ranking Edge-wear on Flocked Fabrics: AATCC Method 142. Stain Release Replicas: AATCC Method 130. Wrinkle Recovery Plastic Replicas: AATCC Method 128. Foaming: AATCC Method 167.

¹Gray Scale for Color Change: AATCC Evaluation Procedure 1.

A Summary of ASTM Methods for Interlaboratory Testing

Developed in 1992 by AATCC Committee RA102.

I. ASTM Standard D 2904, Standard Practice for Interlaboratory Testing of a Textile Test Method that Produces Normally Distributed Data, and ASTM Standard D 2906, Standard Practice for Statements on Precision and Bias for Textiles, are guides for planning interlaboratory tests to evaluate proposed test methods and for using the test results to write precision statements of normally distributed data. It is intended that these methods as well as ASTM Standard D 4467, Interlaboratory Testing of a Textile Test Method that Produces Non-Normally Distributed Data, be used as guides in the development of information for precision and bias statements in AATCC test methods.¹ This monograph is a summary of the vital parts of the ASTM standards and are the minimum conditions that should be used in developing precision and bias statements for AATCC test methods. Components of variance for single operator, within laboratory, and between laboratory effects are determined. Critical differences calculated from the component variances indicate, for averages of "n" specimens from different samples, the minimum differences which are statistically significant.

II. Parameters in the Interlaboratory Test

A. Materials: There should be a minimum of two materials representing the range of interest of the property being tested. Subsamples of materials should be as homogeneous as possible. Where possible, values for each material should be established by alternative methods to determine if there is a variable bias between the proposed method and the referee method at different levels of the property.

B. Laboratories: There should be a minimum of five laboratories.

C. Operators: A minimum of two operators within each laboratory is recommended; however, testing by a single operator is acceptable.

D. Specimens: There should be a minimum of two specimens tested by each op-

erator in each laboratory *from each material*. The number of specimens tested per operator should be determined from the established variance for the test (determined from tests on one material by one operator in one laboratory) and the smaller systematic effect it is desired to be able to detect. Procedures for calculation of the required number of specimens are detailed in Section 5.5 of ASTM Standard D 2905. It is advisable to test a larger number of materials in more laboratories with the number of operators per laboratory and the number of tests per operator at a minimum of two each. The order of tests should be randomized to eliminate any storage or time effects.

E. Instruments: This should not be an effect included in the statistical analysis. When multiple instruments are used in a laboratory, ascertain if differences among instruments exist, and if they do, use known standard samples to obtain correction factors.

III. Procedure

A. A preliminary within-laboratory ruggedness test should be performed prior to interlaboratory testing. It is also advisable to conduct a pilot scale interlaboratory test before full scale testing.

B. Obtain an adequate number of samples and code for distribution to laboratories. The materials should be completely randomized for assignment to laboratories. It may be necessary in some cases to employ partial randomization. For example, in testing yarn from different spinning frames, specimens from each frame may be allocated to each laboratory. Determine subsample homogeneity before distribution to laboratories.

C. Conduct tests at each laboratory according to the procedure of the proposed test method.

IV. Analysis

A. An analysis of variance (ANOVA) is used to determine the significance of effects (operators, laboratories) in the interlaboratory test. This procedure assumes uniformity of variances. If variances are not uniform, data transformations such as those suggested in Section 11 of ASTM Standard D 2904 may be required.

B. ANOVA for single materials.

1. Prepare a separate ANOVA for each material, using a specially designed statistics package from ASTM or

ANOVA procedures available in other statistical software packages (SAS, SPSS). In the latter case, the effects in the model should include laboratory, operator nested within laboratory and specimen nested within operator and laboratory as the sources of variation. The analysis will yield F-values for each effect, and these can be used to determine if significant differences exist between operators and/or between laboratories. Alternatively, the variances can be calculated by hand using the formulas in Annex A2 of ASTM Standard D 2904.

2. Determine the components of variance using either the ASTM or other statistical package. This calculation is part of the ASTM program, but it will require an additional procedure if other standard statistical packages are used (e.g., VARCOMP in SAS). Formulas for calculation of the components of variance are also given in Annex A2 of ASTM Standard D 2904.

3. Calculate the critical differences for each of the effects using the components of variance. The ASTM program provides these critical differences for selected numbers of specimens, or they may be calculated using the equation in Sections 8.2 and 8.4 of ASTM Standard D 2906. The critical differences for each material should be compared to determine if they are sufficiently similar to combine the data for all materials into a single ANOVA table. An engineering decision should be made on the practical importance of the observed variation in the critical differences for materials. The auxiliary tests listed in Section 15 of ASTM Standard D 2904 are helpful in making this determination.

C. ANOVA for all materials.

1. If the critical differences for all materials are sufficiently similar, prepare an ANOVA table which includes all materials. Determine significant effects with F-tests. The ASTM program will perform these analyses directly. For other programs, the effects included in the model should be: material, material*laboratory interaction, operator within laboratory, material*operator within laboratory interaction and specimen within operator and laboratory.

2. Calculate the components of variance and critical differences as before. The component of variance for materials is usually not calculated as the materials were deliberately chosen to exhibit different levels of the property of interest.

¹ASTM Standards D 2904, D 2906 and D 4467 available from ASTM, 100 Barr Harbor Dr., West Conshohocken PA 19428; tel: 610/832-9500; fax: 610/832-9555.

3. If neither materials*laboratory or material*operator within laboratory is significant, do not include these in the precision statement. However, if either of these effects is significant, different components of variance apply to situations involving one material or more than one material. This means that the test method evaluates materials differently when tested in different laboratories or by operators within laboratories. In these cases *both* single material and multi-material components of variance should be calculated, with the latter including the components of variance for the materials interactions. (See Section A2.14.2.2 of ASTM Standard D 2904 for further explanation.)

V. Report or Precision Statement

A. Describe the interlaboratory test in terms of numbers of materials, laboratories, operators within laboratories and specimens tested by each operator.

B. Report the components of variance

(as variances or as standard deviations) and the critical differences for selected numbers of specimens, for each of the effects determined from the analysis including all materials. If the material interactions are not significant, report critical differences between specimens tested by each operator, between operators and between operators within laboratories.

C. If the materials interactions are significant, report both single and multi-material components of variance and critical differences, for single operator, within laboratory and between laboratory effects.

D. In the case of arbitrary grades, or of other grades that are limited and not continuous, or for which meaningful transformations may not be practicable (such as the AATCC Gray Scale), Recommended Text 8—Special Cases of Ratings in ASTM Standard D 2906 may be used. Most rating scales in AATCC methods are limited and not continuous.

Appendix

I. Definitions of terms (these definitions are taken from ASTM Standards D 123 and E 456)

A. **nested experiment**, n.—an experiment to examine the effect of two or more factors in which the same level (version) of a factor cannot be used with all levels (versions) of other factors.

B. **ruggedness test**, n.—a planned experiment in which environmental factors of test conditions are deliberately varied in order to evaluate the effects of such variation.

C. **standard deviation**, n.—the positive square root of the variance.

D. **specimen**, n.—a specific portion of a material or laboratory sample upon which a test is performed or which is taken for that purpose. (Syn. *test specimen*.)

E. **variance**, n.—a measure of the squared dispersion of observed values or measurements expressed as a function of the sum of the squared deviations from the population mean or sample average.

A Glossary of AATCC Standard Terminology

AATCC Blue Wool Lightfastness Standard, n.—one of a group of dyed wool fabrics distributed by AATCC for use in determining the amount of light exposure of specimens during lightfastness testing. *Source:* TM (Test Method) 16, 111, 192.

AATCC fading unit (AFU), n.—a specific amount of exposure made under the conditions specified in various test methods where one AFU is one-twentieth (1/20) of the light-on exposure required to produce a color change equal to Step 4 on the Gray Scale for Color Change or 1.7 ± 0.3 CIELAB units of color difference on AATCC Blue Wool Lightfastness Standard L4. *Source:* TM 16.

abrasion, n.—the wearing away of any part of a material by rubbing against another surface. *Source:* TM 93, 119, 120.

absorbance, n.—the logarithm to the base 10 of the reciprocal of transmittance.

NOTE: Absorbance is proportional to the mass of absorbing material in the path length of a spectrophotometer cell (syn: *absorbance value*). *Source:* TM 182.

absorbency, n.—the propensity of a material to take in and retain a liquid, usually water, in the pores and interstices of the material. *Source:* TM 70, 79.

absorption, n.—a process in which one material (the absorbent) takes in or incorporates another material (the absorbate) within itself; such as the absorption of moisture by fibers. *Source:* Committee RA93.

accelerated ageing, n.—*in textile processing and testing*, use of controlled environmental conditions to promote rapid physical and/or chemical change in a textile material. *Source:* TM 26.

acid dye, n.—an anionic dye having substantivity for fibers which contain cationic groups usually in acidic or neutral aqueous dyebaths. *Source:* TM 159.

activated oxygen bleach, n.—a bleaching system comprising an oxygen bleach and a bleach activator. *Source:* TM 190.

activity, n.—*of an antibacterial agent*, a measure of effectiveness of the agent. *Source:* TM 100, 147, 174.

add-on, n.—*in textile processing*, the amount of any material, chemical finish, coating, sizing, etc. that is applied to a textile. (see also *wet pick-up*.)

NOTE: Add-on is usually determined as a percentage of either the dry or conditioned weight of the textile prior to processing. *Source:* Committee RA93.

ageing, accelerated, n.—see *accelerated ageing*.

anionic dye, n.—a dye that dissociates in aqueous solution to give a negatively charged colored ion. *Source:* Committee RA87.

antibacterial agent, n.—any chemical material which kills bacteria (bactericide) or interferes with the multiplication, growth or activity of bacteria (bacteriostat). *Source:* TM 100, 147, 174.

antifungal agent, n.—any chemical material which kills or inhibits the growth of fungi. *Source:* TM 174.

antimicrobial agent, n.—*in textiles*, any chemical material which kills or inhibits the growth of microorganisms. *Source:* TM 174.

appearance of creases, n.—see *crease retention*.

appearance of textile end products, n.—the overall visual impression of a textile end product quantified by comparison of individual components with appropriate reference standards. *Source:* TM 143.

aqueous repellency, n.—*in textiles*, the characteristic of a fiber, yarn or fabric whereby it resists wetting by aqueous liquids. *Source:* TM 193.

area-of-view, n.—*of color measuring instrument*, the dimensions of the surface area that a color measuring instrument is capable of covering in a single color measurement. *Source:* Evaluation Procedure 6.

azoic composition, n.—a physical mixture of an azoic coupling component and a stabilized azoic diazo component which produces, *in situ*, an insoluble azo colorant in both cellulosic and synthetic substrates. *Source:* Committee RA87.

azoic diazo component, n.—a stabilized diazonium salt of a primary acrylamine or derivative thereof which is capable of reacting with an azoic coupling component. *Source:* Committee RA87.

azoic dye, n.—an insoluble azo compound developed, *in situ*, on a substrate by chemically reacting an azoic diazo component (diazotized amine) with an azoic coupling component. *Source:* Committee RA87.

Bacterial Amylase Unit (BAU), n.—a measure of starch degradation as shown by the quantity of an enzyme that will dextrinize one milligram of starch per minute under the specified experimental conditions. *Source:* TM 103.

bacterial resistance, n.—*in textiles*, resistance to the development of visible bacterial growth and accompanying odors, resulting from bacterial degradation of fibers or soil on them, as distinguished from

musty fungal odors. *Source:* TM 174.

ballast, n.—*in procedures for processing or testing of textiles*, material that is used to bring the total weight or volume of the textiles to an amount specified in the procedure. *Source:* TM 88B, 88C, 124, 143.

barré, n.—an unintentional, repetitive visual pattern of continuous bars and stripes usually parallel to the filling of woven fabric or the courses of circular knit fabric.

NOTE: The term barré is sometimes used as a synonym for “filling bands.” Barré in warp knit fabrics is most often referred to as “warp streaks.” *Source:* TM 178.

basic dye, n.—a dye that dissociates in an aqueous medium to give a positively charged colored ion (cation) with affinity for fibers containing acidic groups. *Source:* TM 141.

black panel thermometer, n.—a temperature measuring device, the sensing unit of which is coated with black designed to absorb most of the radiant energy encountered in lightfastness testing. *Source:* TM 16, 111, 181, 192.

black standard thermometer, n.—a temperature measuring device, the sensing unit of which is coated with a black material designed to absorb most of the radiant energy encountered in lightfastness testing and is thermally insulated by means of a plastic plate. *Source:* TM 16.

bleach, n.—*in home laundering*, a product that will clean, whiten, brighten and aid in the removal of soils and stains from textile materials by oxidation that is inclusive of chlorine and non-chlorine products. *Source:* TM 172, 188.

bleach, n.—*in textiles*, an oxidizing or reducing agent used to partly or completely destroy natural or extraneous coloring matter in a textile, thereby leaving the textile lighter or whiter. *Source:* Committee RA93.

bleach activator, n.—a bleach agent precursor, which converts a less potent bleaching species into a more powerful one. *Source:* TM 190.

bleaching, n.—elimination of unwanted coloring matter from a textile substrate by oxidative or reductive chemical treatment. *Source:* TM 81, 102.

blue wool lightfastness standard, n.—one of a group of dyed wool fabrics which are sensitive to the amount of light, heat, and moisture to which they are exposed.

NOTE: Because of the unstable nature of these materials they are also sensitive

to the heat and moisture conditions which exist before exposure testing, after exposure testing and prior to measurement. *Source:* TM 181.

bond strength, n.—in *bonded and laminated fabrics*, the tensile force expressed in g/cm (oz/in.) of width required to separate the component layers under specified conditions. *Source:* TM 136.

bonded fabric, n.—a layered fabric structure wherein a face or shell fabric is joined to a backing fabric with an adhesive that does not significantly add to the thickness of the combined fabrics.

NOTE 1: In this context, a thin layer of foam is considered an adhesive when the cell structure is completely collapsed by a flame.

NOTE 2: Normally, but not always, the backing fabric may be tricot or non-woven. *Source:* TM 136.

breaking strength, n.—the maximum force applied to a specimen in a tensile test carried to rupture. *Source:* TM 111, 169, 186, 192.

broad bandpass radiometer, n.—a relative term applied to radiometers that have a bandpass width of more than 20 nm at 50% of maximum transmittance and can be used to measure irradiance at wavelengths such as 300-400 nm or 300-800 nm. *Source:* TM 16, 111.

burnt gas fumes, n.—atmospheric oxides of nitrogen as derived from the combustion of illuminating or heating gas. *Source:* TM 23.

bursting strength, n.—the force or pressure required to rupture a textile by distending it with a force, applied at right angles to the plane of the fabric, under specified conditions. *Source:* TM 111, 169, 186, 192.

carbonizing, n.—a chemical process for eliminating cellulosic matter from a mixture with animal fibers by degrading the cellulosic material to an easily friable condition. *Source:* Committee RA93.

care instructions, n.—in *textiles*, a series of directions describing which care practices should refurbish a product without adverse effects and warning of those care practices expected to have a harmful effect. *Source:* TM 172, 188.

carpet, n.—all textile floor coverings not designated as rugs. *Source:* TM 121, 122, 123, 138, 165, 171.

carpet pile brush, n.—a hand operated brush having long, semi-rigid bristles intended specifically for erecting the pile of small areas of carpet. (see also *pile lifter*.) *Source:* TM 171.

cationic dye, n.—a dye that dissociates in an acidified, aqueous solution to give a positively charged colored ion. *Source:* Committee RA87.

cellulase enzyme, n.—an enzyme that attacks cellulose. *Source:* TM 191.

center wavelength, n.—the specified wavelength for a bandpass filter; the

wavelength midway between the half power points, for example, 340 nm \pm 2 nm. *Source:* TM 111.

chelating agent, n.—in *textile chemistry*, a chemical capable of deactivating metal ions by formation of a water soluble complex. SYN: *sequestering agent*. *Source:* TM 149, 161, 168.

chemical finish, n.—chemical material other than colorants and residual processing chemicals added to textiles to impart desired functional or aesthetic properties to the textile product. *Source:* TM 94.

chemical finishing, n.—the process of applying chemicals, other than colorants, to textiles to impart desired functional and/or aesthetic characteristics which may or may not be durable in normal use. *Source:* Committee RA93.

chroma, n.—the proportion of spectrally pure color that expresses the degree of departure from the gray of the same lightness; i.e., brighter or duller. *Source:* Evaluation Procedure 9.

chrome dye, n.—a mordant dye capable of forming a chelate complex with a chromium ion. *Source:* Committee RA87.

CIE 1976 L*a*b* equation, n.—a commonly used equation which transforms CIE tristimulus values into a three-dimensional opponent color space. Generally abbreviated as CIELAB. *Source:* TM 173.

CIE chromaticity coordinates, n.—the ratio of each of the tristimulus values of a psychophysical color to the sum of the tristimulus values (ASTM E 284). *Source:* TM 110.

CIE tristimulus values, n.—amounts of three non-real reference color stimuli required to give a color match with the color stimulus considered, and defined by the CIE for the CIE 1931 standard observer and the CIE 1964 supplementary standard observer and for a particular illumination condition. *Source:* TM 110.

clean-fiber content, n.—the amount of fiber after removal of nonfibrous content. *Source:* TM 20A.

cleaning head, n.—a vacuum head modified with spray nozzles for cleaning solution application. Some types include a powered brush unit to facilitate wetting and soil release. *Source:* TM 171.

cleanness, n.—in *carpet soiling tests*, the absence of change in appearance due to soil, specifically the degree to which the specimen approaches the original clean, unsoiled condition. (see also *soil affinity*.)

NOTE: Cleanness is independent of changes of physical structure which may be present because of exposure to traffic or action of cleaning procedures. *Source:* TM 121.

CMC unit, n.—in *color difference evaluation*, a measure of acceptability expressed in terms of the boundary for the

CMC acceptability ellipsoid of $\Delta E_{cmc} = 1.0$.

NOTE: CMC is an acronym for the Colour Measurement Committee (of the Society of Dyers and Colourists) which was largely responsible for the development of the CMC (*l:c*) equation. *Source:* TM 173.

coated fabrics, n.—a flexible material composed of a textile fabric and an adherent polymeric or other material applied to one or both surfaces. *Source:* Committee RA93.

color change, n.—as used in *colorfastness testing*, a change in color of any kind (whether a change in hue, chroma or lightness) *Source:* TM 16, 181, 192.

color change, n.—a change in color of any kind whether in lightness, hue or chroma or any combination of these, discernible by comparing the test specimen with a corresponding untested specimen. *Source:* Evaluation Procedures 1, 7, TM 111.

color strength, n.—a measure of the ability of a dye to impart color to other materials.

NOTE: Color strength is evaluated by light absorption in the visible region of the spectrum. *Source:* TM 182.

colorant, n.—a material which is applied to a substrate for the express purpose of changing the transmittance or reflectance of visible light.

NOTE: Dyes, pigments, tints and optical brighteners are examples of colorants; soils are not colorants. *Source:* TM 140, Evaluation Procedure 4.

colorant bleeding, n.—the loss of colorant from a textile substrate during contact with a liquid medium (such as water, drycleaning solvent or condensed vapors) with consequent coloring of the medium. *Source:* Committee RA93.

colorant staining, n.—the unintended pickup of colorant by a substrate due to (1) exposure to a colored or contaminated liquid medium, or (2) direct contact with dyed or pigmented material from which colorant transfers by sublimation or mechanical action (as in crocking). *Source:* TM 137, Evaluation Procedures 2, 3, 8.

colorfastness, n.—the resistance of a material to change in any of its color characteristics, to transfer of its colorant(s) to adjacent materials or both, as a result of the exposure of the material to any environment that might be encountered during the processing, testing, storage or use of the material. *Source:* TM 6, 8, 15, 16, 23, 61, 101, 104, 106, 107, 109, 116, 117, 125, 129, 131, 132, 133, 139, 157, 162, 163, 164, 165, 169, 172, 188, 190, Evaluation Procedures 1, 2, 8.

colorfastness to light, n.—the resistance of a material to a change in its color characteristics as a result of exposure of the material to sunlight or an artificial light source. *Source:* TM 16.

colorist, n.—in *textile coloration*, a

person experienced in developing color formulas, evaluating samples for color and producing colored samples to meet standards. *Source:* Committee RA93.

color measuring instrument, n.—any device, such as a colorimeter or spectrophotometer, used to measure the relative amounts of energy reflected from (or transmitted through) a specimen in the visible region of the energy spectrum (comprising the wavelengths from 360-780 nm, and including as a minimum the region from 400-700 nm). *Source:* Evaluation Procedure 6.

color measurement, n.—a numerical representation of the color of an object obtained by use of a color measuring instrument. A single measurement may represent an average of multiple readings of a specimen. *Source:* Evaluation Procedure 6.

commercial factor (cf), n.—in *color difference evaluation*, a tolerance (specified in terms of ΔE_{cmc} units) which adjusts all axes of the unit CMC volume equally to create a volume of acceptance for commercial use. *Source:* TM 173.

commercial laundering, n.—a process by which textile products or specimens may be washed, rinsed, bleached, dried and pressed in commercial laundering equipment, typically at higher temperatures, higher pHs and longer times than used for home laundering. *Source:* TM 96.

compatibility, n.—in *textile dyeing*, propensity of individual dye components in a combination shade to exhaust at similar rates resulting in a buildup of shade that is constant, or nearly constant, in hue throughout the dyeing process. *Source:* TM 141.

condensed dye, n.—a dye which, during or after application, reacts covalently with itself or other compounds, other than the substrate, to form a molecule of greatly increased size. *Source:* Committee RA87.

consolidation dimensional change, n.—the dimensional change that occurs when a fabric is gently agitated in water to overcome all the frictional constraints in it after it has been allowed to relax in water without agitation. *Source:* TM 99.

constituent elements of hand, n.—those components, qualities, attributes, dimensions, properties or impressions which make the sensation of touching one fabric different from that of touching another. *Source:* Evaluation Procedure 5.

copper chelation value (CuCV), n.—the milligrams of copper sulfate pentahydrate chelated by one gram of a chelating agent or product containing a chelating agent. *Source:* TM 185.

crease retention, n.—in *fabrics*, the visual impression of an inserted crease quantified by comparison with a set of reference standards. *Source:* TM 88C,

143.

crocking, n.—a transfer of colorant from the surface of a colored yarn or fabric to another surface or to an adjacent area of the same fabric principally by rubbing. *Source:* TM 8, 116, 165.

cross dyeing, n.—a process of dyeing textiles containing fibers having different dye affinities to achieve a multicolored effect. (see also *union dyeing*.) *Source:* Committee RA93.

ΔE_{cmc} , n.—in *color difference evaluation*, a single number defining the total color difference in CMC units of a trial from a standard. *Source:* TM 173.

depth, n.—departure of a colored object from white and frequently associated with either concentration or efficiency of a colorant. *Source:* Evaluation Procedure 4.

detergent, n.—a cleaning agent containing one or more surfactants as the active ingredient(s). *Source:* Committee RA93.

differential wear—see *frosting*.

dimensional change, n.—a generic term for variation in length or width of a garment or fabric specimen subjected to specified conditions. *Source:* TM 158.

dimensional change, n.—a generic term for changes in length or width of a fabric specimen subjected to specified conditions. The change is usually expressed as a percentage of the initial dimension of the specimen. *Source:* TM 96, 99, 135, 150, 160, 187.

dimensional restoration, n.—a return toward a former or original length or width dimension. *Source:* TM 160.

direct dye, n.—an anionic dye having substantivity for cellulosic fibers, normally applied from an aqueous dyebath containing an electrolyte. *Source:* Committee RA87.

disperse dye, n.—an essentially water insoluble dye having affinity, when properly dispersed, for polyester, polyamide and some other manufactured polymeric fibers. *Source:* TM 146, 154, 176.

dispersibility, n.—the degree to which particles can be broken down to some minimum size such that they will pass through the interstices of a standard filter paper. *Source:* TM 146.

dispersion, n.—in *textile wet processing*, a suspension of very fine particles in a liquid phase. *Source:* TM 176.

drycleaning, n.—the cleaning of fabrics with organic solvents such as petroleum solvent, perchloroethylene or fluoro-carbon.

NOTE: The process also includes adding detergent and moisture to the solvent, up to 75% relative humidity, and hot tumble drying to 71C (160F). *Source:* TM 86, 132, 142, 158.

dryer creases, n.—sharp folds or lines running in any direction in a laundered or dried specimen.

NOTE: Dryer creases are an unin-

tended result of restricted movement of specimens in the washer or the dryer. *Source:* TM 88B, 88C, 124, 143.

dummy load, n.—see *ballast*.

durable press, adj.—having the ability to retain substantially the initial shape, flat seams, pressed-in creases and unwrinkled appearance during use and after laundering or drycleaning. *Source:* TM 88B, 88C, 124, 143.

dust, n.—fine particles of solid material dispersed in a gas. *Source:* TM 184.

dusting, n.—the tendency of particles of sufficiently low mass to become airborne when a powder material is handled or agitated. *Source:* TM 170.

dye, n.—a colorant applied to or formed in a substrate, via the molecularly dispersed state, which exhibits some degree of permanence.

NOTE: Definitions for individual classes of dyes may be found under their particular class name; i.e., reactive dye. *Source:* TM 140, 163, 170.

dyeing, n.—in *textile manufacturing*, application of a dye to a substrate normally with the intention of obtaining an even distribution throughout the substrate. *Source:* Committee RA93.

electrical resistance, n.—the physical property of a material which is a measure of the ability of electrons to flow through it when a voltage is applied across two points on the material (resistance [in ohms] equal voltage [in volts] divided by current flow [in amperes]). *Source:* TM 84.

electrical resistivity, n.—material property of a substance whose numerical value is equal to the ratio of the voltage gradient to the current density. *Source:* TM 76.

electrostatic clinging, n.—adherence of one substance to another caused by an electrical charge on one or both surfaces. *Source:* TM 115.

electrostatic propensity, n.—the ability to produce and accumulate an electrostatic charge. *Source:* TM 134.

erythema, n.—abnormal redness of the skin (sunburn) due to capillary congestion (as in inflammation). *Source:* TM 183.

extractable matter, n.—nonfibrous material in or on a textile substrate, not including water, which is removable by a specified solvent or solvents as directed in a specified procedure. *Source:* TM 97.

face, n.—in *textiles*, the side of a fabric that is intended to be the outer visible surface in an end product. *Source:* TM 22.

felting dimensional change, n.—the irreversible dimensional change that occurs in a consolidated wool fabric when it is subjected to agitation in laundering. *Source:* TM 99.

fiber, n.—in *textiles*, a generic term for any one of the various types of matter that form the basic elements of a textile and which are generally characterized by

flexibility, fineness and high ratio of length to thickness. *Source:* TM 20A.

fibrillation—see *frosting*.

finish, n.—*other than in preparation and coloration*, the result of application of mechanical energy, thermal energy, or chemical materials, separately, or together, to a textile product to impart durable or nondurable functional or aesthetic properties not otherwise obtainable. *Source:* Committee RA93.

finishing, n.—the process of applying mechanical energy, thermal energy or chemical materials to a textile product. (see also *finish*.) *Source:* Committee RA93.

flock, n.—*in textiles*, very short fibers intended for application to a substrate as a partial or complete surface covering or filler. *Source:* Committee RA93.

fluidity, n.—*of a cellulose solution*, a measure of the ease of flow or motion of a solution, and therefore an indicator of the molecular weight of the cellulose. *Source:* TM 82.

fluorescence, n.—a phenomenon in which radiant flux of certain wavelengths is absorbed and re-emitted nonthermally at other, usually longer, wavelengths. *Source:* Evaluation Procedure 6.

fluorescent brightener, n.—see *fluorescent whitening agent*. *Source:* Committee RA87.

fluorescent UV lamp, n.—a lamp in which radiation at 254 nm from a low-pressure mercury arc is transformed to longer wavelength UV by a phosphor. *Source:* TM 186.

fluorescent whitening agent (FWA), n.—colorant that absorbs near ultraviolet (UV) radiation and re-emits visible (violet-blue) radiation. This causes a yellowish material to which it has been applied to appear whiter (ASTM E 284). *Source:* TM 110.

fluorine content, n.—*in textile floor coverings*, the ratio of the weight of total elemental fluorine to the total weight of carpet fibers. *Source:* TM 189.

foam, n.—a dispersion of a gas in a liquid or solid. *Source:* TM 167.

foam tear, n.—*in laminated fabrics*, a condition wherein the foam portion of the fabric ruptures prior to the failure of the bond. *Source:* TM 136.

formaldehyde release, n.—that formaldehyde evolved from textiles under the accelerated storage conditions of this test including that which is free (unbound or occluded) from unreacted chemicals or from finish degradation as a result of this test. *Source:* TM 112.

frictional constraint, n.—*in textile wet processing*, the resistance to fiber movement imposed by fiber to fiber contacts within a fabric. *Source:* TM 99.

frosting, n.—*in textiles*, a change of fabric color caused by localized abrasive wear. (Syn: *differential wear, fibrillation*.)

NOTE: Frosting may be the result of differential wear, as in multicomponent blends in which the fibers do not match in shade, or of the abrasion of single-fiber constructions in which there is a variation in or incomplete penetration of dye. *Source:* TM 119, 120.

fulling, n.—a textile finishing process in which cloth is subjected to moisture, heat, friction and pressure. *Source:* Committee RA93.

garment, n.—a shaped article of textile fabric, or other flexible sheet material, intended to cover portions of the human body. *Source:* TM 150.

garment twist, n.—a rotation, usually lateral, between different panels of a garment resulting from the release of latent stresses during laundering of the woven or knitted fabric forming the garment. Twist may also be referred to as torque or spirality. *Source:* TM 179.

geometry, n.—*of a color measuring instrument*, one of the following terms (diffuse/0, 0/diffuse, 0/45 or 45/0) which describe the angle or manner in which a color measuring instrument:

(1) illuminates the specimen (diffuse, 0, 45)

(2) views the resulting reflected light (0 [0°-10°], diffuse, 45, 0).

Diffuse/0 and 0/diffuse geometry instruments contain a sphere used to diffuse the light illuminating [or reflected from] the specimen, while 0/45 and 45/0 geometry instruments generally use mirrors or fiber optics to direct the illumination [or viewing] at a 45 angle to the specimen.

NOTE: Instruments of different geometries may produce different colorimetric results on most textile materials. *Source:* Evaluation Procedure 6.

grade, n.—*in textile testing*, the symbol for any step of a multistep standard reference scale for a quality characteristic.

NOTE: The grade is assigned to test specimens exhibiting a degree of the quality comparable to that step of the standard. Numerical grades assigned to different specimens from a sample or by different observers are commonly averaged. *Source:* TM 118, 193, Evaluation Procedure 8.

Gray Scale, n.—a scale consisting of pairs of standard gray chips representing progressive differences in color or contrast corresponding to numerical color-fastness grades. *Source:* Evaluation Procedures 1, 2.

gray scale grade, n.—*for color change (GSc)*, the numerical value that is assigned to the change in color of a test specimen as compared to an original or untreated specimen. *Source:* Evaluation Procedure 7.

growth, n.—a dimensional change resulting in an increase in the length or width of a specimen. *Source:* TM 96, 99,

135, 150, 160, 187.

half-power bandpass, n.—the interval between wavelengths at which transmittance is 50% of peak transmittance in a bandpass filter.

NOTE: The interval should not exceed 20 nm for a narrow bandpass filter. *Source:* TM 111.

hand, n.—the tactile sensations or impressions which arise when fabrics are touched, squeezed, rubbed or otherwise handled. *Source:* Evaluation Procedure 5.

hot pressing, n.—a process for smoothing and possibly shaping textile products by applying mechanical pressure with heat, either dry or in the presence of moisture. *Source:* TM 133.

hot water extraction, n.—a method of cleaning carpet by injecting a heated cleaning solution into the pile and quickly removing the solution and soil by vacuum. (see also *steam cleaning*.)

NOTE: Hot water extraction is often erroneously called “steam cleaning.” Hot water is used at a temperature of 60 ± 3C (140 ± 5F). These temperatures are far below the temperature of steam of 100C (212F). *Source:* TM 171.

hue, n.—the attribute of color perception by means of which an object is judged to be red, orange, yellow, green, blue, violet or a combination of these. *Source:* Evaluation Procedures 4, 9.

hydrostatic pressure, n.—the force distributed over an area exerted by water. *Source:* TM 127.

infrared radiation, n.—radiant energy for which the wavelengths of the monochromatic components are greater than those for visible radiation and less than about 1 mm.

NOTE: The limits of the spectral range of infrared radiation are not well defined and may vary according to the user. Committee E-2.1.2 of the CIE distinguishes in the spectral range between 780 nm and 1 mm:

IR-A	780-1400 nm
IR-B	1.4-3.0 μm
IR-C	3 μm to 1 mm

Source: TM 16.

ingrain dye, n.—a colorant which is formed, *in situ*, in the substrate by the development and coupling of one or more intermediate compounds.

NOTE: The term was originally used for colorants obtained from oxidation bases and by azoic techniques, but is now reserved for other types of colorant formed *in situ*. *Source:* Committee RA87.

insect resistance, n.—*in textiles*, the capability to impede damage by insects. *Source:* TM 24, 28.

irradiance, n.—radiant power per unit area as a function of wavelength expressed as watts per square meter, W/m². *Source:* TM 16, 111, 169, 186.

irradiation, n.—the time integral of ir-

radiance expressed in joules per square meter (J/m^2). *Source*: TM 111, 169, 181, 192.

“L” designation, n.—the sequence number given each AATCC Blue Wool Lightfastness Standard according to the number of AATCC Fading Units required to produce a color change equal to Step 4 on the AATCC Gray Scale for Color Change. *Source*: TM 16, 177.

laboratory sample, n.—a portion of material taken to represent the lot sample, or the original material, and used in the laboratory as a source of test specimens. *Source*: TM 111, 181, 192.

laminated fabric, n.—a layered fabric structure wherein a face or outer fabric is joined to a continuous sheet material, such as polyurethane foam, in such a way that the identity of the continuous sheet material is retained.

NOTE 1: Either the flame or adhesive method of laminating can be used.

NOTE 2: Normally, but not always, the sheet material is joined to a backing fabric.

NOTE 3: Normally, but not always, the backing fabric may be tricot or non-woven, and the sheet material may be polyurethane. *Source*: TM 136.

langley, n.—a unit of total solar radiation equivalent to one gram calorie per square centimeter of irradiated surface.

NOTE: The internationally recommended units are: Joule (J) for quantity of radiant energy, watt (W) for quantity of radiant power, and meter squared (m^2) for area. The following factors are to be used: 1 langley = 1 cal/cm^2 ; 1 cal/cm^2 = 4.184 J/cm^2 or 41840 J/m^2 . *Source*: TM 16.

laundering, n.—of textile materials, a process intended to remove soils and/or stains by treatment (washing) with an aqueous detergent solution and normally including subsequent rinsing, extracting and drying. *Source*: TM 61, 88B, 88C, 96, 99, 124, 135, 142, 143, 150, 160, 172, 179, 187, 188, 190.

leuco dye, n.—a soluble reduced form of a dye from which the original dye may be regenerated by oxidation. (see also *vat dye* and *sulfur dye*.) *Source*: Committee RA87.

leuco sulfur dye, n.—a sulfur dye composition consisting of the leuco compound in the presence of a small excess of a reducing agent. *Source*: Committee RA87.

leveling, n.—in textile dyeing and finishing, the process leading to more uniform distribution of a chemical or dye within a substrate or between substrates. (compare *transfer*, *migration*.) *Source*: Committee RA93.

lightfastness, n.—the property of a material, usually an assigned number, depicting a ranked change in its color characteristics as a result of exposure of the

material to sunlight or an artificial light source. *Source*: TM 16, 125.

lightness, n.—the amount of light reflected from a non-self-luminous textile material or the attribute of color perception by which such a surface is judged to reflect more or less light than another surface; i.e., darker or lighter. *Source*: Evaluation Procedure 9.

lot, n.—in bonded or laminated fabric, a single run on the bonding or laminating machine in which the processing is carried out without stopping or changing processing conditions and consisting of either a single dye lot or a single greige goods lot. *Source*: TM 136.

mass coloration, n.—a method of coloring manufactured fibers by incorporation of the colorant in the spinning composition before extrusion into filaments. *Source*: Committee RA87.

mechanical finishing, n.—the process of applying mechanical energy to textiles to impart functional and/or aesthetic characteristics. *Source*: Committee RA93.

mercerization, n.—a process for irreversibly altering the physical characteristics and appearance of natural cellulosic fibers by swelling in strong alkali. *Source*: TM 43, 89.

metal-complex dye, n.—a dye having a coordinated metal atom in its molecule.

NOTE: Unless the term *metal-complex dye* is used in direct association with a particular application class of dye, e.g., *metal-complex disperse dye* or *metal-complex reactive dye*, its use is inexact and inadvisable. *Source*: Committee RA87.

metal sensitivity, n.—the propensity of a dye to produce an abnormal color on a textile material when in the presence of certain metal ions. *Source*: TM 161.

metallizable dye, n.—a dye capable of forming a dye-metal complex either in substance (see *metal-complex dye*) or on the substrate. *Source*: Committee RA87.

metamerism, n.—the attribute of two colored materials, which match under one illuminant and to one observer, but do not match when exposed to a different illuminant (having a different spectral power distribution) or when viewed by another observer. *Source*: Evaluation Procedure 9.

migration, n.—the nonuniform movement and distribution of dyes, pigments, finishes or other materials from one part of a material to another. *Source*: TM 157.

migration, n.—in textile processing, testing, storage and use, movement of a chemical, dye or pigment between fibers within a substrate or between substrates due to capillary forces. (see also *transfer*.) *Source*: TM 140.

mildew resistance, n.—in textiles, resistance to development of unsightly fungal growths and accompanying unpleas-

ant, musty odors on textile materials exposed to conditions favoring such growths. *Source*: TM 30, 174.

moisture content, n.—that part of the total mass of a material that is absorbed or adsorbed water, compared to the total mass. *Source*: TM 20A.

mordant, n.—a substance, usually a metallic compound, applied to a substrate to form with a dye a complex which is retained by the substrate more firmly than the dye itself. *Source*: Committee RA87.

mordant dye, n.—a dye that is fixed with a mordant. *Source*: Committee RA87.

nap, n.—the raised fibrous surface of a fabric obtained by a mechanical brushing or other raising process. (compare *flock*, *pile*.) *Source*: Committee RA93.

narrow bandpass radiometer, n.—a relative term applied to radiometers that have a bandpass width of 20 nm or less at 50% of maximum transmittance and can be used to measure irradiance at wavelengths such as 340 or 420, ± 0.5 nm. *Source*: TM 16, 111.

non-chlorine bleach, n.—a bleach that does not release the hypochlorite ion in solution; i.e., sodium perborate, sodium percarbonate. *Source*: TM 172.

nonfibrous content, n.—products such as fiber finishes, yarn lubricants, slasher sizing, fabric softeners, starches, china-clay, soaps, waxes, oils and resins which are applied to fiber, yarn, fabric or apparel. *Source*: TM 20A.

oil repellency, n.—in textiles, the characteristic of a fiber, yarn or fabric whereby it resists wetting by oily liquids. *Source*: TM 118.

onium dye, n.—a cationic dye that is solubilized by a labile ammonium, sulfonium, phosphonium or oxonium substituent which splits off during fixation to leave an insoluble colorant in the fiber. *Source*: Committee RA87.

optical brightener, n.—see *fluorescent whitening agent*. *Source*: Committee RA87.

oxygen bleach, n.—a bleach agent which can liberate hydrogen peroxide by hydrolysis upon dissolving in water. *Source*: TM 190.

percent UV blocking, n.—100 minus the UV transmission. *Source*: TM 183.

perfect reflecting diffuser, n.—ideal reflecting surface that neither absorbs nor transmits light, but reflects diffusely, with the radiance of the reflecting surface being the same for all reflecting angles, regardless of the angular distribution of the incident light. (ASTM E 284).

NOTE: The perfect reflecting diffuser is the basis of calibration of reflectance measuring instruments. The equations for whiteness and tint are formulated so that the CIE concept of the perfect reflecting diffuser has a whiteness index of 100.0 and a tint value of 0.0. *Source*: TM 110.

permanent press, n.—see *durable press*.

perspiration, n.—a saline fluid secreted by the sweat glands. *Source*: TM 15, 125.

pH, n.—the negative logarithm of the effective hydrogen ion concentration or hydrogen ion activity in gram equivalents per liter used in expressing both acidity and alkalinity on a scale whose values run from 0-14 with 7 representing neutrality, numbers less than 7 increasing acidity, and numbers greater than 7 increasing alkalinity. *Source*: TM 81.

photochromism, n.—a qualitative designation for a reversible change in color of any kind (whether a change in hue or chroma) which is immediately noticeable upon termination of light exposures when the exposed area of a specimen is compared to the unexposed area.

NOTE: The reversion of the color change or instability of the hue or chroma upon standing in the dark distinguishes photochromism from fading. *Source*: TM 16, 139.

pigment, n.—a colorant in particulate form which is insoluble in a substrate, but which can be dispersed in the substrate to modify its color. *Source*: TM 140, 176.

pilate, n.—see *pile lifting*. *Source*: TM 171.

pile, n.—in *textile fabrics*, yarn loops or tufts protruding from the plane of a fabric, incorporated into the fabric by any means, and which later might be cut, sheared or brushed. *Source*: Committee RA93.

pile lifter, n.—a vacuum cleaning device with motorized rotating brushes designed to erect and agitate carpet pile to facilitate soil removal. (see also *carpet pile brush*.) *Source*: TM 171.

pile lifting, n.—the act of erecting the pile tufts of a carpet with a *carpet pile brush*, *pile lifter* or *pile rake* to allow imbedded soil to be more easily removed and erecting the pile after cleaning to restore a uniform overall appearance. (also called *pilate*.) *Source*: TM 171.

pile rake, n.—a hand tool with smooth circular plastic tines used for pile lifting. *Source*: TM 171.

pleating, n.—the process of making one or more desirable folds in a cloth by doubling the material over on itself. *Source*: TM 131.

pool water, n.—water in a large container to which various chemicals are added to maintain purity and clarity, normally used for swimming. *Source*: TM 162.

premetallized acid dye, n.—an acid dye manufactured by reacting an equivalent of a suitable metal ion with one equivalent of a dye (1:1 premetallized acid dye), or with two equivalents of the same or different dyes (1:2 premetallized acid dyes), capable of chelating the

metal. *Source*: TM 159.

preparation, n.—in *textile manufacturing*, those processing operations performed on greige fabric, colored fabric, textile yarns or fibers to ready them for dyeing, printing or finishing.

NOTE: For example, typical greige cotton fabric preparation includes singeing, desizing, scouring, bleaching and (optionally) mercerizing. *Source*: Committee RA93.

prespotting, n.—in *cleaning*, a pretreatment to remove or enhance removal of soil or stains in a local area. (see also *spotting*.) *Source*: Committee RA93.

printing, n.—in *textile manufacturing*, a process for applying colorants or other materials to the surface of a substrate, usually to produce a design. *Source*: Committee RA93.

professional wetcleaning, n.—a process for cleaning sensitive textiles (e.g., wool, silk, rayon, linen) in water by professionals using special technology, detergents and additives to minimize the potential for adverse effects. It is followed by appropriate drying and restorative finishing procedures. *Source*: Committee RA43.

pyranometer, n.—a radiometer used to measure the global solar irradiance or, if inclined, hemispherical solar irradiance. *Source*: TM 16, 111.

radiant energy, n.—energy traveling through space in the form of photons or electromagnetic waves of various lengths. *Source*: TM 111, 169, 186.

radiant exposure, n.—time integral of irradiance. *Source*: TM 111, 181.

radiant flux density, n.—rate of flow of radiant energy past the specimen. *Source*: TM 111, 169.

radiant power, n.—energy per unit time emitted, transferred or received as radiation. *Source*: TM 16, 111, 169.

radiometer, n.—an instrument used to measure radiant energy. *Source*: TM 16, 111.

rating, v.—in *textile testing*, the process for determining or assigning a grade to a material by comparing it to a standard reference scale. *Source*: Evaluation Procedure 8.

reactive dye, n.—a dye that, under suitable conditions, is capable of reacting chemically with a substrate to form a covalent dye-substrate linkage. *Source*: Committee RA87.

reference fabric, n.—one or more blue wool lightfastness standards selected for exposure as a check on a test apparatus and operating conditions. *Source*: TM 111, 192.

reference plastic, n.—a clear polystyrene plastic standard selected for exposure as a check on a test apparatus and operating conditions. *Source*: TM 111, 192.

reference standard, n.—a homogeneous lot of material having a known or accepted value for one or more physical

or chemical properties and selected for use to verify performance of test apparatus under specified operating conditions. *Source*: TM 181.

reference standard, n.—a material that defines the specific color to be matched, and may also be used to define other appearance properties, such as finish, texture and construction. *Source*: Evaluation Procedure 9.

reflectance, n.—the ratio of the reflected radiant or luminous energy (light) to the incident energy in the given conditions. *Source*: Evaluation Procedure 6.

reflectance factor, n.—the ratio of the light reflected from the specimen to the light reflected from the perfect reflecting diffuser under the same geometric and spectral conditions of measurement. *Source*: Evaluation Procedure 6.

relaxation dimensional change, n.—the dimensional change that occurs when a fabric is immersed in water without agitation so that the strains and stresses put into fibers, yarns or fabrics during previous processing stages such as spinning, weaving or knitting and finishing are relieved. *Source*: TM 99.

relative color strength, n.—in *spectrophotometric testing of dyes*, the percentage of the color strength of a sample relative to that of a reference dye assigned a color strength of 100%. *Source*: TM 182.

restoration force, n.—the energy brought to bear on a fabric to accomplish a dimensional restoration. *Source*: TM 160.

retained chlorine, n.—in *textiles bleached with chlorine-type bleaches*, available chlorine which remains in the material after washing and drying. *Source*: TM 92, 114.

rewetting agent, n.—in *textile preparation, dyeing and finishing*, a surfactant which, after application and drying onto textiles, promotes rapid wetting on subsequent exposure to an aqueous solution. *Source*: TM 27.

rhe, n.—the unit of fluidity; the reciprocal of the unit of viscosity (the poise). *Source*: TM 82.

rot resistance, n.—in *textiles*, resistance to deterioration of a textile material as a result of fungal growth in or on it.

NOTE: Such deterioration is normally assessed by measuring loss in tensile strength. *Source*: TM 30, 174.

rug, n.—a textile floor covering of limited area which is complete in itself and is intended for use as a partial covering of a floor or another floor covering. *Source*: TM 137, 165, 171.

rug back, n.—(1) that part of a rug normally in contact with the floor; (2) the underside of a rug as opposed to the use surface. *Source*: TM 137.

scouring, n.—in *textile processing*, treatment of textile materials in aqueous or other solutions to remove nature fats,

waxes, proteins and other constituents as well as dirt, oil and other impurities. *Source:* Committee RA93.

seam smoothness, n.—*in fabrics*, the visual impression of planarity of a seamed specimen quantified by comparison with a set of reference standards. *Source:* TM 88B, 143.

semi-axes (LS_L , cS_C , S_H), n.—*in color difference evaluation*, individual dimensions of the CMC volume which are used to calculate a ΔE_{CMC} value. *Source:* TM 173.

sequestering agent, n.—see *chelating agent*.

shade change, n.—a change from the normal or expected color of a textile material. (see also *color change*.) *Source:* TM 161.

shading, n.—*in colored textile fabrics*, gradual changes in hue, chroma and/or lightness lengthwise or widthwise.

NOTE: When unintended, shading is considered a defect; may be intentional for styling purposes. *Source:* Committee RA93.

skewness, n.—a fabric condition resulting when filling yarns or knitted courses are angularly displaced from a line perpendicular to the edge or side of the fabric (see ASTM Terminology D 123). *Source:* TM 179.

shrinkage, n.—a dimensional change resulting in a decrease in the length or width of a specimen. *Source:* TM 96, 99, 135, 150, 160, 187.

smoothness appearance, n.—*in fabrics*, the visual impression of planarity of a specimen quantified by comparison with a set of reference standards. *Source:* TM 124, 128, 143.

sodium hypochlorite bleach, n.—4-6% solution of sodium hypochlorite (NaOCl), pH 9.8-12.8, commonly called "chlorine bleach." *Source:* TM 188.

soil, n.—dirt, oil or other substances not normally intended to be present on a substrate such as a textile material. *Source:* TM 121, 122, 123, 130.

soil affinity, n.—the reduction in reflectance between new and soiled fabrics. (see also *cleanness*) *Source:* TM 151.

soiling, n.—*in textiles*, a process by which a textile substrate becomes more or less uniformly covered with/or impregnated with soil. *Source:* TM 121, 122, 123.

soil redeposition, n.—the soiling of clean or relatively clean fabric during the laundering process by soil which has been removed from another fabric. *Source:* TM 151.

soil release, n.—the degree to which a soiled substrate approaches its original, unsoiled appearance as a result of a care procedure. *Source:* TM 130.

soil resist agent, n.—a material applied to, or incorporated in, carpet face fiber which retards and/or limits the build-

up of soil. *Source:* TM 189.

solubilized sulfur dye, n.—a thiosulfuric acid derivative of a sulfur dye which during dyeing is converted to the substantive alkali-soluble thiol form. *Source:* Committee RA87.

solubilized vat dye, n.—a water-soluble salt of the sulfuric ester of a leuco vat dye.

NOTE: After application to the fiber the parent vat dye is regenerated by hydrolysis and oxidation. *Source:* Committee RA87.

solvent dye, n.—a dye which is soluble in organic solvents, but not in water, and is widely used in lacquers, inks, waxes, plastics, soaps, cosmetics, fuels and colored smokes. *Source:* Committee RA87.

specimen, n.—a specific portion of a material or laboratory sample upon which a test is performed or which is selected for that purpose. *Source:* TM 111, 181, 192.

speck, n.—a small particle, such as an agglomerate in a liquid dispersion, or a very small spot of dark color on a dyed substrate. *Source:* TM 176.

speckiness, n.—*in textile dyeing and printing*, the quality or state of containing specks. *Source:* TM 176.

spectral energy distribution, n.—the variation of energy due to the source over the wavelength span of the emitted radiation. *Source:* TM 111, 169, 186, 192.

spectral transmittance, n.—the percent of incident radiant energy passing through a given material and not absorbed in the process, as a function of wavelength. *Source:* TM 111, 169.

specular reflection, n.—the reflection without diffusion, in accordance with the laws of optical reflection, as in a mirror. *Source:* Evaluation Procedure 6.

spin finish, n.—a material applied to manufactured fibers by the producer to facilitate subsequent processing.

NOTE: Spin finishes may lubricate yarns, alter hand and bulk, control slippage in wet finishing, maintain package density, etc. *Source:* Committee RA93.

spotting, n.—*in cleaning*, application of solvent or solution to a material prior to or after commercial scouring, laundering, or drycleaning to remove or enhance removal of soil or stains in a local area. (see also *prespotting*.) *Source:* Committee RA93 and TM 157.

stability, n.—*of dye dispersions*, the resistance to chemical decomposition, physical disintegration, agglomeration or any combination of these. *Source:* TM 166.

stain, n.—a local deposit of soil or discoloration on a substrate that exhibits some degree of resistance to removal, as by laundering or drycleaning. *Source:* TM 130.

stain, n.—*for pile floor covering*, a discoloration due to a color adding material, such as food or liquid, that exhibits resistance to removal by standard cleaning methods. *Source:* TM 175.

stainblocker, n.—a chemical sub-

stance which, when applied to a textile substrate, imparts partial or total resistance to staining. *Source:* TM 175.

standard atmosphere for testing textiles, n.—air maintained at $21 \pm 1\text{C}$ ($70 \pm 2\text{F}$) and $65 \pm 2\%$ relative humidity. *Source:* TM 111, 169, 186, 192.

standard depth scale, n.—*in color measurement*, a series of dyed samples of different hue and chroma that have been accepted to have the same depth. *Source:* Evaluation Procedure 4.

standardization, n.—*of color measuring instrument*, the act of measuring one or more standard materials with a color measuring instrument for the purpose of calculating a set of correction factors to be applied to all subsequent measurements. *Source:* Evaluation Procedure 6.

steam cleaning, n.—see the correct term, *hot water extraction*. *Source:* TM 171.

steaming, n.—*in textile dyeing or printing*, treatment with moist steam to promote penetration and/or fixation of the dye.

NOTE: The steam may be neutral, acid, or air-free depending on the dye class. *Source:* Committee RA93.

stone-washed, adj.—*in garment processing*, a descriptive term denoting alteration of the appearance of a new garment to give it a worn or laundered appearance. SYN: *washdown*. *Source:* Committee RA93.

substrate, n.—*in textiles*, a fiber, fiber assembly, yarn, fabric or film to which another material is applied. *Source:* Committee RA93.

sulfur dye, n.—a dye, containing sulfur both as an integral part of the chromophore and in attached polysulfide chains, normally applied in the alkali-soluble reduced (leuco) form from a sodium sulfide solution and subsequently oxidized to the insoluble form in the fiber. *Source:* Committee RA87, TM 26.

surface active agent, n.—see *surfactant*. *Source:* Committee RA93.

surfactant, n.—a soluble or dispersible material which reduces the surface tension of a liquid, usually water. *Source:* Committee RA93.

tearing strength, n.—the average force required to continue a tear previously started in a fabric. *Source:* TM 111, 169, 192.

textile floor covering, n.—an article having a use-surface composed of textile material and generally used for covering floors. *Source:* TM 121, 122, 123, 138, 165, 171.

thermal finishing, n.—the process of applying heat to textiles to impart desired functional and/or aesthetic characteristics.

NOTE: Thermal finishing includes heat setting, hot embossing, etc. but excludes drying. *Source:* Committee RA93.

thermal fixation, n.—the use of dry

heat to achieve a degree of permanence when applying colorants to textile materials. *Source:* TM 154.

tinctorial strength, n.—the effectiveness of a given mass of dye in coloring a given mass of material. *Source:* Evaluation Procedure 4.

tint, n.—a colorant, applied to a substrate for purposes of identification, which is easily removed from the substrate by subsequent wet treatment. *Source:* Committee RA93.

tint, n.—in *whiteness measurement*, the hue of a white material as influenced by the wavelength of peak emission or reflectance (CIE 15.2). *Source:* TM 110.

total irradiance, n.—radiant power integrated over all wavelengths at a point in time expressed in watts per square meter (W/m^2). *Source:* TM 16, 169, 181.

tolerance range specimens, n.—selected specimens which deviate from the reference standard in hue, lightness, chroma, or in combinations of the three, and impose a range of observable color differences around the reference standard for evaluation purposes. *Source:* Evaluation Procedure 9.

transfer, n.—in *textile processing, testing, storage and use*, movement of a chemical, dye or pigment between fibers within a substrate or between substrates. (see also *migration, leveling*.) *Source:* TM 155, 156, 159, 163.

transmittance, n.—of *light*, that fraction of the incident light of a given wavelength which is not reflected or absorbed, but passes through a substance.

NOTE: In this test, the transmittance of the material is measured on a spectrophotometer, and corrected for that of pure solvent for the same path length. *Source:* TM 182.

transmittance, n.—the ratio of transmitted light to incident light under specified geometric and spectral conditions.

NOTE: Regular transmittance (of transparent materials) is the ratio of undiffused transmitted light to incident light. *Source:* Evaluation Procedure 6.

transmittance factor, n.—the ratio of the light transmitted by a specimen and evaluated by a receiver to the light passing through the same optical system and evaluated by the receiver when the specimen is removed from the system. *Source:* Evaluation Procedure 6.

ultraviolet protection factor (UPF), n.—the ratio of the average effective ultraviolet radiation (UV-R) irradiance transmitted and calculated through air to the average effective UV-R irradiance transmitted and calculated through fabric. *Source:* TM 183.

ultraviolet radiation, n.—radiant energy for which the wavelengths of the monochromatic components are smaller than those for visible radiation and more than about 100 nm.

NOTE: The limits of the spectral range of ultraviolet radiation are not well defined and may vary according to the user. Committee E-2.1.2 of the CIE distinguishes in the spectral range between 400 and 100 nm:

UV-A	315-400 nm
UV-B	280-315 nm
UV-C	100-280 nm

Source: TM 16, 111, 181.

ultraviolet radiation, n.—radiant energy for which the wavelengths of the monochromatic components are smaller than those for visible radiation and more than about 100 nm.

NOTE: The limits of the spectral range of ultraviolet radiation are not well defined and may vary according to the user. Committee E-2.1.2 of the CIE distinguishes in the spectral range between 400 and 100 nm:

UV-A	315-400 nm
UV-B	280-315 nm
UV-R	280-400 nm

Source: TM 183, 186.

union dyeing, n.—a process of dyeing textiles containing fibers having different dye affinities to achieve the appearance of a uniform, homogenous color. (see also *cross dyeing*.) *Source:* Committee RA93.

unlevelness, n.—in *textile dyeing and finishing*, nonuniform distribution of a dye or chemical in or on a substrate. (compare *leveling and shading*.) *Source:* Committee RA93.

use-surface, n.—of *textile floor covering*, the part of a textile floor covering directly exposed to foot traffic. *Source:* TM 121, 122, 123, 138, 165, 171.

UV-A Type Fluorescent UV lamp, n.—a fluorescent UV lamp where radiant emission below 300 nm is less than 2% of its total light output. *Source:* TM 186.

UV-B Type Fluorescent UV lamp, n.—a fluorescent UV lamp where radiant emission below 300 nm is more than 10% of its total light output. *Source:* TM 186.

vat dye, n.—a water-insoluble dye, usually containing keto groups, which is normally applied to the fiber from an alkaline aqueous solution of the reduced enol (leuco) form which is subsequently oxidized in the fiber to the insoluble form. *Source:* TM 176.

verification standard, n.—in *color measurement*, any stable material which is used for the purpose of confirming (or verifying) the validity of an instrument standardization. Color measurements, which are made immediately following standardization, are compared to original measurements of the standard to detect improper standardization. *Source:* Evaluation Procedure 6.

visible radiation, n.—any radiant energy capable of causing a visual sensation.

NOTE: The limits of the spectral range of visible radiation are not well defined and may vary according to the user. The lower limit is generally taken between 380 and 400 nm and the upper limit between 760 and 780 nm (1 nanometer, 1 nm = 10^{-9} m). *Source:* TM 16, 111.

volume of acceptability, n.—in *color difference evaluation*, the volume of the ellipsoid obtained when each semi-axis (L_S, cS_C, S_H) is multiplied by cf—creating an agreed volume describing the limits of commercial acceptability for the color difference about a standard. *Source:* TM 173.

wand, n.—a tool used to deliver cleaning solution to carpets and apply vacuum to remove the solution.

NOTE: A *wand* usually consists of an extension handle and a *cleaning head*. Various types are light weight wand, drag wand (heavy duty) and power wand which has a motorized rotating or vibrating part to aid soil release. *Source:* TM 171.

washdown, n.—in *processing new fabrics or garments*, a change in appearance to give a worn or laundered look resulting from washing, scouring, chemical, mechanical, or other treatment, including any combination of such treatments. (see also *stone-washed*.) *Source:* Committee RA93.

washing, n.—in *textile processing*, vigorous treatment with water, usually heated, to remove impurities, chemicals, or dyes in preparation, dyeing, or finishing. *Source:* Committee RA93.

washing, n.—in *testing textile floor coverings*, a specific wet cleaning process involving the use of detergent and scrub brush to remove soil and/or extraneous matter residing in the pile fibers. *Source:* TM 138.

water repellency, n.—in *textiles*, the characteristic of a fiber, yarn or fabric to resist wetting. (see also *water resistance*.) *Source:* TM 22, 70, 127.

water resistance, n.—of *fabric*, the characteristic to resist wetting and penetration by water. (see also *water repellency*.) *Source:* TM 35, 42, 127.

weather, n.—climatic conditions at a given geographical location including such factors as sunlight, rain, humidity and temperature. *Source:* TM 111, 169, 186, 192.

weather resistance, n.—ability of a material to resist degradation of its properties when exposed to climatic conditions. *Source:* TM 111, 169, 186, 192.

wet pick-up, n.—in *textile processing*, the amount of liquid, and material carried by the liquid, applied to a textile. (see also *add-on*.)

NOTE: Wet pick-up is usually determined as a percentage of either the dry or conditioned weight of the textile prior to processing. *Source:* Committee RA93.

wet processing, n.—in *textile manufacturing*, a collective term for processes

included in preparation, dyeing, printing and finishing in which the textile material is treated with a liquid, normally water, or with chemicals in solution or dispersion in a liquid. *Source:* TM 81, 144.

wet soiling, n.—the application of soil from a liquid medium. *Source:* TM 151.

wetting agent, n.—a chemical compound which when added to water lowers both the surface tension of the liquid and its interfacial tension against the solid material. *Source:* TM 17, 27, 43.

whiteness, n.—the attribute by which an object color is judged to approach a preferred white (ASTM E 284). *Source:* TM 110.

wool, n.—used in the generic sense, fiber from the fleece of the sheep or lamb, hair from the Angora or Cashmere goat, rabbit hair, and the so-called specialty hair fibers from camel, alpaca, llama and vicuna. *Source:* TM 96, 99.

wool oil, n.—a lubricant applied to wool or hair fibers to facilitate subsequent processing. *Source:* Committee RA93.

wrinkle recovery, n.—that property of

a fabric which enables it to recover from folding deformations. *Source:* TM 66, 128.

xenon reference fabric, n.—a dyed polyester fabric used for verifying xenon-arc equipment test chamber temperature conditions during a lightfastness test cycle. *Source:* TM 16.

yarn lubricant, n.—a material applied to yarn to reduce friction and static generation and thus facilitate subsequent processing. *Source:* Committee RA93.

zone of inhibition, n.—clear area of no growth of a microorganism, cultured onto the surface of agar growth medium, in proximity to the borders of a specimen placed in direct contact with this agar surface.

NOTE: A zone of inhibition occurs as result of the diffusion of an antimicrobial agent from the specimen. *Source:* TM 147, 174.

Appendix A References

A.1 *A Dictionary of Textile Terms*, 12th ed., 1976; Dan River Inc., 111 West 40th St., New

York NY 10018.

A.2 *ASTM D 123, Standard Terminology Relating to Textiles*; ASTM, 100 Barr Harbor Dr., West Conshohocken PA 19428; tel: 610/832-9500; fax: 610/832-9555.

A.3 *ASTM E 284, Standard Definitions of Terms Relating to Appearance of Materials*; ASTM, 100 Barr Harbor Dr., West Conshohocken PA 19428; tel: 610/832-9500; fax: 610/832-9555.

A.4 *Colour Terms and Definitions*, 2nd ed., 1988; Society of Dyers and Colourists, P.O. Box 244, Perkin House, 82 Grattan Rd., Bradford, West Yorkshire BD1 2JB, ENGLAND.

A.5 *Fairchild's Dictionary of Textiles*, 7th edition, 1995; Phyllis Tortora and Robert S. Merkel, Eds., Fairchild Publications, New York NY.

A.6 *Knitting Dictionary*, 1966; National Knitted Outerwear Association, 51 Madison Ave., New York NY 10010.

A.7 *Dictionary of Fiber and Textile Technology*, 1990; Hoechst Celanese Corp., P.O. Box 32414, Charlotte NC 28231.

A.8 *Textile Terms and Definitions*, 9th edition, 1991; The Textile Institute, 10 Blackfrairs St., Manchester M3 5DR, ENGLAND.

AATCC Style Guide for Writing Test Methods

1. Purpose of Testing

1.1 Objectives

1.1.1 AATCC test methods are used in two ways: in rapid routing control of mill processes and in precise analyses required for research work. Hence the author must know when, where and how a test method is to be used, and by whom, and must write the method accordingly.

2. Organization of Test Methods

2.1 Scope

2.1.1 The most common headings of test methods and their sequence are standardized to promote uniform style. Few methods will require all the sections provided, but the list of headings may be augmented as needed. Do not replace the titles or headings with other terms or rearrange the prescribed order. In 2.2.1, those sections marked by an asterisk are required for all test methods.

2.2 Subdivisions

2.2.1 The following is the prescribed order for the text of AATCC test methods:

- *Title
- Foreword
- *Purpose and Scope
- *Principle
- *Terminology
- *Safety Precautions
- Uses and Limitations
- Apparatus, Reagents, Materials**
- Verification, Calibration**
- Sampling
- Specimens
- Conditioning
- Preparation of Apparatus, Specimens, Reagents**
- *Procedure
- *Calculations, Interpretation, Evaluation**
- Report
- *Precision and Bias
- References
- Notes
- Appendices

*Required for all test methods.

**Use appropriate heading.

2.3 Modified Decimal System

2.3.1 Using the modified decimal system, number each series of sections and subdivisions serially and set off these numbers by periods (decimal points) to indicate the particular part of the method from the largest division or section, down to the individual paragraphs. For example: "2." indicates the second principal section of a method; "2.3 and 2.14" designate respectively the third and fourteenth subdivisions of primary division 2.; similarly, "2.14.10" designates the tenth paragraph or subdivision of the fourteenth division of the second section of the method.

2.3.2 Use no longer than three-place numbers. For example: A two-place number means 2.14; a three-place number means a symbol such as 2.14.1 or 2.14.10. This numbering not only shows at a glance the arrangement of the written material, but also permits simple and specific cross referencing. Numbers with more than three places defeat the purpose of simplicity. The need for more than three places can usually be avoided by making more primary and secondary subdivisions of the subject or by using fewer subdivisions.

2.4 Title

2.4.1 Name the property to be measured, not some quality to be inferred. Keep the title explicit and terse. For example: "Loss of Strength in Rayon Cloth by Exposure to Sulfurous Acid"; not "Resistance of Fabric to Acid Damage." "Biological Oxygen Demand in Textile Mill Effluents" not "Stream Sanitation."

2.4.2 In order to simplify finding methods in alphabetical listing, key words that describe the general nature of the test should be used in the beginning of the title followed by more specific descriptive terms. For example, AATCC Method 162, Colorfastness to Water: Chlorinated Pool.

2.5 Foreword

2.5.1 State briefly the history of the test method including the number of the committee which developed it, the first year of publication and the year of all subsequent reaffirmations, editorial revisions and technical revisions. Also list any similar test methods of other organizations such as ISO.

2.6 Purpose and Scope

2.6.1 Name the properties to be tested, the material to which the tests are applicable and the characteristics to be inferred. If the method contains a series of tests on several attributes, list them.

2.6.2 State categories wherein the method should not be attempted.

2.6.3 Keep all methods anonymous; they are pronouncements of AATCC.

2.7 Principle

2.7.1 Briefly sketch the technique, outlining the fundamental physical and chemical concepts involved.

2.8 Terminology

2.8.1 Define all terms not found in the ordinary desk dictionary, and all terms used in some specialized sense. Define terms that are used only in one restricted branch of the textile industry. If a definition is taken from some other publication, quote it in full and give due credit by complete attribution.

2.8.2 Define all key terms in titles to ensure that all persons referring to or using the test method understand its intent.

2.9 Safety Precautions

2.9.1 A generic caveat on precautions shall appear in all test methods.

2.9.2 This generic caveat shall appear in the Safety Precautions section of the appropriate test methods.

2.9.3 The generic caveat shall be: NOTE: These safety precautions are for information purposes only. The precautions are ancillary to the testing procedures and are not intended to be all inclusive. It is the user's responsibility to use safe and proper techniques in handling materials in this test method. Manufacturers MUST be consulted for specific details such as material safety data sheets and other manufacturer's recommendations. All OSHA standards and rules must also be consulted and followed.

2.9.4 Where the test method does not involve the use of hazardous materials, operations and equipment, an exception to the inclusion of the generic caveat may be presented to AATCC Committee RA100 on Safety, Health and Environmental Technology.

2.9.5 Specific precautionary statement(s), where appropriate, shall be included in the body of the test method. These statements shall not prescribe specific remedial measures and actions.

However, reference may be made to authoritative sources where reliable information concerning remedial measures can be obtained.

2.9.6 When there exists in a test method a specific precautionary statement(s), reference to the appropriate section(s) shall be made following the generic caveat.

2.10 Uses and Limitations

2.10.1 Show how the test results may best be used, and discuss inferences that may legitimately be drawn from the data. Point out where the results are not useful and particularly where they might be misleading.

2.10.2 If cost of testing is a consideration, compare it with other cheaper, acceptable but perhaps less accurate methods.

2.11 Apparatus, Reagents, Materials

2.11.1 Separate the subject into two or three separate sections if there will be more than 10 items per section. In a text note, show where any unusual item may be procured. Check the source for availability.

2.11.2 Do not include preparation of reagents or calibration of apparatus in this section.

2.11.3 Include as apparatus only special equipment which is not in the catalogs of laboratory supply houses, or apparatus which is rarely used. Include spectrophotometers, projection microscopes and Launder-Ometers. Do not include such ordinary items as scissors. Common glassware, such as beakers, burettes, and flasks, need not be listed, but may be listed, if it is felt test method efficacy is enhanced.

2.11.4 List all reagents—acids, bases, salts, etc.—using chemical names not trade names; for example, sodium hydroxide, not caustic soda. Include chemical formulae for all reagents. If a complex organic compound is used the formula may be omitted but the proper name as accepted by the Geneva Convention should be used.

2.11.5 Unless otherwise stipulated, assume all chemical reagents are of ACS Reagent quality; and construe “water” as distilled or deionized to not over 15 ppm total solids and not less than 50,000 ohms resistance.

2.11.6 Among materials, include unusual things like multifiber test fabric, standard color swatches, standard photographs of defects and reference spectra.

2.11.7 AATCC policy prohibits endorsement of commodity specifications. The ratings suggested in some of the methods serve as a guide; but they are not intended for and must not be construed as commodity standards.

2.12 Verification, Calibration

2.12.1 Instruments and equipment must be periodically verified to protect against any drift due to time, wear or accident. Such checks may be made by the operator every time a test is performed, or perhaps daily, like checking the zero point of analytical balances. The check may be rarely performed, as when installing new apparatus or setting up after a major relocation; or the check may be part of good laboratory management that is performed as weekly or monthly routine. Include day-to-day verification in PROCEDURE. Infrequent checks belong in a separate appendix. Include verifications that are part of laboratory routine and which should be put on a regular schedule.

2.12.2 Besides mechanical adjustments, include calibration curves, standard curves and verification of normality (or molarity) of standard solutions.

2.12.3 Describe the preparation of standard reagents; also standard curves or tables relating the quantity of an unknown with reference to color transmission, conductance, pH or other property of a standard solution.

2.13 Sampling

2.13.1 Test results are valid only when the samples are statistically representative.

2.13.2 Sampling must be random. Every unit of product must have a mathematically equal chance of becoming a sample; and every portion of each sample must be equally likely to become a test specimen.

2.13.3 All specimens must be alike within the variations due to pure chance. There must be no differences within samples assignable to known causes. If test results are not in a normal or other recognizable distribution, the test method is not in control.

2.13.4 Include in each method a brief sampling plan. State either the number of specimens to test per sample and the number of samples per product, or else state the required coefficient of variation of the mean, and permit the operator to determine the volume of testing.

2.13.5 If the number of tests is stipulated in a method, state the expected precision of the mean and the probability. If the operator is to compute the number of tests, to meet a stipulated precision of a mean, provide an expected coefficient of variation (CV) from background experience. If (CV) is unknown, provide for its estimation by methods in any standard test on statistics, or consult ASTM Standard D 2905, Statements on Number of Specimens Required to Determine the Average Quality of Textiles.

2.14 Specimens

2.14.1 Describe the size, shape and weight of specimens. Include any limitations on the location or choice of test material; but put details of trimming, mounting and conditioning in other sections.

2.15 Conditioning

2.15.1 Stipulate the atmospheres in which the specimens must be pre-conditioned and conditioned for testing.

2.15.2 If the samples or specimens must reach moisture equilibrium, state it something like: “Let specimens reach moisture equilibrium with atmosphere at [(a) ± (b)] C, [(x) ± (y)] F, and [(m) ± (n)]% Relative Humidity. Approach equilibrium from the dry side (but not oven-dry).” If the final moisture regain is critical, stipulate also the preconditioning time, temperature and relative humidity.

2.15.3 Define moisture equilibrium as having been attained when the progressive gain in weight does not exceed (k)% of conditioned weight per hour of exposure.

2.16 Preparation of Apparatus, Specimens and Reagents

2.16.1 Include here all preparatory or preliminary steps. Include trimming edges of specimens, pulling threads to trace weave patterns, leveling and adjusting equipment, etc.

2.17 Procedure

2.17.1 Procedures are operating instructions for technicians and must permit trained technicians, working in separate laboratories, to obtain results that are comparable within agreed limits, with little or no other guidance.

2.17.2 State all operating instructions clearly, simply and unequivocally. Leave no room for differing techniques. Recite every needed detail in proper sequence.

2.17.3 Avoid such “weasel” words and generalizations as “suitable” beaker, stir “frequently,” add “exactly” 10 mL, or oil bearings “periodically.” If the container is a critical item, name it, such as “a 250-mL wide-mouthed Erlenmeyer flask”; but if a Florence flask, a casserole or any beaker that comes handy will do as well, do not stipulate it. If time is important, state narrow limits, like “stir for 30 ± 1 s.” Where time is less important, state wider limits, such as “let solutions settle 2-3 h.” Say “water at 140-160°F,” not “hot water.” Say “water at room temperature” or “ice water,” not “rinse in cold water.” Say “add 10.00 ± 0.02 mL” not “add exactly 10 mL.”

2.17.4 Indicate the number of significant figures to record in observations. Be sure the accuracy is mathematically justified.

2.17.5 When two equally acceptable procedures give statistically interchangeable results, spell out each procedure and state that either may be used.

2.17.6 Occasionally a choice lies between a slow, expensive but very precise test method, and a cheaper, more rapid method that is adequate for process control. If separate methods are not justified, state the two techniques in one method as "preferred" and "alternate." Record the precision of each, and include a correlation coefficient or regression curve to show the relation between the two sets of results.

2.17.7 Write procedures in the second person imperative format.

2.18 Calculation, Interpretation, Evaluation

2.18.1 Calculation involves straightforward computation without exercise of opinion. Include as calculation all requisite algebra and arithmetic. State exactly what is to be computed and how. State the number of significant figures required in all calculations.

2.18.2 For subsequent reference in texts, number each equation in a sequence by a numeral in parentheses at the right margin of the line.

2.18.3 Indicate multiplication by parentheses () () and division by the solidus (/). Write:

$$x = 100 (A - B)/C$$

$$y = 100 (0.00587) (A - B)/C$$

2.18.4 Keep formulas on one line of typescript if possible. Write:

$$x = (A - B)/C$$

2.18.5 Use symbols in current use. For x is less than or equal to y , write:

$$x \leq y$$

2.18.6 Restrict equations to symbols and numerals. Write:

$$x = 100 (A - B)/C$$

where:

x = iron as Fe, percent of oven dry specimen weight.

2.18.7 Keep all numerals at the left side of expressions that contain both numerals and letters. Write:

$$x = 100 (0.00587) (A - B)/C$$

2.18.8 Do not condense chemical or physical equations. It makes checking of computations difficult. Write:

$$x = 100 (0.00587) (A - B)/C$$

2.18.9 Confirm the position of the decimal point in all decimal fractions by putting a zero in the units column. Write:

$$a = 0.3010B$$

2.18.10 When a mathematical development requires two or more lines, place the statements in column, repeating only the equality sign. Write:

$$n = (t^2) (v^2)/(e^2)$$

$$= (1.96^2) (7.5^2)/(5^2)$$

$$= 8.6$$

$$= 10 \text{ (to the nearest higher multiple of 5)}$$

2.18.11 Show the basis of percentage statements. Write:

"Moisture content, % of conditioned weight"

2.18.12 Include a sample computation whenever an equation is long, involved or in the least degree difficult to reduce to English.

2.18.13 Use the heading "Interpretation" in place of or in addition to "Calculation" when the results are expressed in descriptive form, relative terms or as abstract values. Such results may be expressed in terms of a 5 to 1 rating scale with 5 being best and 1 being worst.

2.18.14 Evaluation of test results implies consideration of several factors, pro and con, and arrival at a considered decision in view of the whole situation. For example color transfer is evaluated against the International Gray Scale, in which hue, brightness and saturation of color in a stained specimen is translated against a scale of graduated neutral gray chips that have neither hue nor brightness but solely the property of saturation.

2.19 Report

2.19.1 Specify the detailed information to be reported.

2.19.2 Require that the test method be cited, and the procedure if there is a choice.

2.19.3 Report in tabular form series of test results involving several samples, several products or numerous replicates. Include a sample work sheet or report form and include typical computations.

2.19.4 Each report must contain, as a minimum:

(a) Arithmetic mean or average (\bar{X})

(b) The number of tests (n)

(c) Standard deviation (s) or coefficient of variation ($\%CV$)

Statement of a mean without the number of tests and precision is essentially useless.

2.20 Precision

2.20.1 *Precision*. A statement on precision allows potential users of the test method to assess in general terms its usefulness in proposed applications. (For an extended discussion, see ASTM D 2906, Statements on Precision and Bias for Textiles.) A statement on precision is not intended to contain values that can be exactly duplicated in every user's laboratory. Instead the statement provides guidelines as to the kind of variability that can be expected between test results when the method is used in one or more reasonably competent laboratories, and when the test method's use is in statistical control. No valid statement can be made about precision unless the use is in statistical control.

2.20.2 Variation in test results is a con-

sequence of variation of the material tested, variation in application of the test method and the character of the test method. With respect to a test method, the statement about precision shall refer to the variation that results from application of the test method to material in which the variation is as small as can reasonably be attained.

2.20.3 The measures of precision discussed below and the presence or absence of statistical control shall be estimated with an interlaboratory test program. When the test results appear to come from certain discrete distributions, precision could be calculated without an interlaboratory test but statistical control could not be established.

2.20.4 Where testing is required to determine precision, every test method shall contain a statement (1) about the precision of test results obtained in the same laboratory under specifically defined conditions of within-laboratory variability, and (2) about the precision of test results obtained in different laboratories. The specifically defined *within-laboratory conditions* may concern test results obtained on the same material by the same operator using the same equipment within a short period of time, or within-laboratory precision may be reported for other specific conditions; for example, between days or between operators. Describe the particular within-laboratory variability for which precision is reported in detail. The statement regarding *between-laboratory* variability must pertain to test results obtained in different laboratories on the same material.

2.20.5 If the test result data are continuous variates, give the standard deviation or coefficient of variation, whichever is appropriate, and the applicable components of variance for each type of precision that is reported. In any case, the precision statement shall give the 95% critical difference for within-laboratory and for *between-laboratory* test data. If the precision is not the same for all materials, then give the precision for each material used in the interlaboratory test that was used to obtain the precision measurements.

2.20.6 File the data obtained in the interlaboratory study and the detailed analysis of the data at the AATCC Technical Center.

2.20.7 The required statement of precision shall contain the information specified above or an explanation as to why a statement is not practicable. The absence of a statement on precision is not warranted if the reason is that an interlaboratory test has revealed that the precision is poor.

2.20.8 If the precision varies with the test level, describe this variation.

2.20.9 Include other related informa-

tion that may help users assess the degree of applicability of the statement to the materials of interest to them. It may be desirable to note the presence of other types of variability in test results on which information can be derived by supplemental studies.

2.20.10 In most cases of arbitrary grades that are limited and not continuous, or for which meaningful transformations may not be practicable, refer to ASTM Standard D 2906, Recommended Text 8—Special Cases of Ratings (see below). Most rating scales in AATCC methods are limited and not continuous. If analysis of variance is used with such data, statistical errors may occur and the possibility should be noted in the precision statement.

RECOMMENDED TEXT 8— SPECIAL CASES OF RATINGS

17. Statements Based on Special Cases of Ratings

17.1 In the case of arbitrary grades or classifications and of scores for ranked data, the observations may have such a complex nonlinear relationship that meaningful transformations may not be practicable. If this is so, use the text illustrated as 111.1 and 111.2 as a guide in giving a subjective basis for evaluating the precision of test results:

111.1 Precision and Bias

111.1 *Interlaboratory Test Data*^A—An interlaboratory test was run in 19XX in which randomly drawn samples of two materials were tested in each of five laboratories. Each laboratory used two operators, each of whom tested four specimens of each material. Calculation of components of variance was thought to be inappropriate due to the restricted and discontinuous rating scales, the non-linear relationships between the rating scales and color difference units, and the increased variability in color difference units as the true value of the ratings decrease.

111.2 *Precision*—Based on the observations described in 111.1 and on general practice in the trade, a lot or consignments is generally considered as having a rating that is significantly worse than a specified value when a specimen from the lot or consignment has a rating for (insert here the name of the property) that is more than one-half step below the specified rating on the AATCC Gray Scale for Color Change.

2.20.11 New or current methods which do not generate data, should contain the following statement: A precision statement is not applicable because data are

not generated by this test method. An alternative for combined Precision and Bias Statement: Precision and Bias statements are not applicable because data are not generated by this test method.

2.20.12 Methods which state only *within-laboratory* precision, add the following as a separate statement: *Between-laboratory* precision has not been established for this test method. Until such precision information is available, users of the method should use standard statistical techniques in making any comparison of test results for *between-laboratory* averages (see 2.20.13).

2.20.13 Analysis of variance or *t*-tests may be used to compare averages. See any standard statistical text for more information.

2.20.14 Any new AATCC test method that produces data shall contain, as a minimum, a statement of single operator precision when first submitted to committee and TCR ballots, but full conformance with 2.20.4 and 2.20.7 are encouraged.

2.20.15 At its first five year reaffirmation, any AATCC test method that produces data shall be brought into full conformance with 2.20.4 and 2.20.7 prior to submission to committee and TCR ballots.

2.20.16 Any longstanding AATCC test method that produces data, which is not currently in conformance with the provisions of 2.20.4 and 2.20.7, shall contain, as a minimum, a statement of single operator precision prior to being submitted to committee and TCR ballot for reaffirmation, but full conformance is encouraged.

2.20.17 At its next five year reaffirmation, any longstanding AATCC test method that produces data, which was previously reaffirmed under 2.20.16, shall be brought into full conformance with 2.20.4 and 2.20.7 prior to being submitted to committee and TCR ballot for reaffirmation.

2.20.18 Research committees are responsible for timely conformance to precision and bias policy, initiation of interlaboratory studies, writing required precision and bias statements, tracking the need for revisions, and keeping to the reaffirmation timetables contained in 2.20.14 through 2.20.17.

2.20.19 In any AATCC test method that produces data in which more than one testing option is allowed, a precision statement based on the most used option satisfies the requirement. A committee may include precision for the other options, and is encouraged to do so, especially single laboratory precision for such options known to be used.

2.20.20 In any longstanding AATCC test method that produces data, as in 2.20.16 and 2.20.17, for which no data are forthcoming, and for which no offers are made to participate in an interlabora-

tory study, the committee may offer the test method for reaffirmation one final time with an explanation under Precision, as provided under 2.20.7, that the necessary actions were taken, but with no positive responses, and that the test method will be put to ballot for withdrawal at the end of the five year period, if nothing further is done.

2.20.21 Precision Statement Format. The precision statement included in a test method must contain three basic sections: (1) a brief description of the testing plan from which the data set was derived, citing the number of materials tested, the number of laboratories participating, the number of operators per laboratory, the number of tests per operator, and any other pertinent information; (2) a listing of the components of variance derived from the data set; and (3) a listing of the precision parameters calculated from the components of variance, usually in the form of critical differences, or confidence intervals. (see ASTM D 2906)

2.21 Bias

2.21.1 *Bias*. A statement on bias furnishes guidelines as to whether the test method can be used when comparisons with accepted reference values are to be made. (For an extended discussion, see ASTM D 2906, Statements on Precision and Bias for Textiles.) If the bias is known, the method can be modified to include a correction for the bias, and thus the corrected method would be without known bias.

2.21.2 If bias varies with the test level, describe the bias.

2.21.3 Any statement on bias shall describe the bias and how the method has been modified to provide corrected test results. If bias cannot be determined, include a statement to this effect.

2.21.4 File the data and details of the experiment to determine bias at the AATCC Technical Center.

2.21.5 For test methods that do not generate data, the statement on bias should read as follows: *Bias*. A bias statement is not applicable because data are not generated by this test method.

2.21.6 For test methods that generate data, the statement on bias should read as follows: *Bias*. The <property name> can be defined only in terms of a test method. There is no independent method for determining the true value. As a means of estimating this property, the method has no known bias.

When applicable, include the following or similar separate statement: AATCC Method XXXX generally is accepted by the textile and apparel industries as a referee method.

2.22 References

2.22.1 Include literature references only when they are essential to performance of the test. Do not include a bibliography.

2.22.2 To cite references, use the format of CHEMICAL ABSTRACTS.

2.23 Explanatory Notes

2.23.1 Notes should contain only explanatory matter, never any mandatory detail of performing the test.

2.23.2 Number notes in sequence as they appear in the text.

2.23.3 Place notes in a separate section at the end of the method, before the appendices. *Exception:* Notes that are part of tables belong with the tables.

2.24 Tables

2.24.1 Use tables to avoid repetition in the text.

2.24.2 Number tables in sequence by Roman numerals.

2.24.3 Place tables in proper sequence in the text, not in the appendices.

2.24.4 Head each table with a terse explicit title. Head each column of figures with a pertinent legend. Below the table, add all necessary notes. Identify the notes by lower case letters. Put the corresponding letter in the body of the table within parentheses.

2.25 Figures and Photographs

2.25.1 Title every line drawing or photograph.

2.25.2 Number figures and photographs in sequence with arabic numerals.

2.25.3 Preferably, use line drawings, with all lettering and the figure drawn to double scale. Drawings usually are clearer than photographs, and have the advantage of showing dimensions and interior surfaces. Have drawings and lettering made by a professional draftsman. The printer will size the illustration to fit the printed page.

2.25.4 Use professional quality glossy photographs with any legend typed on an attached slip of paper.

2.25.5 Place figures and photographs in proper sequence in the text, not in an appendix.

2.26 Appendices

2.26.1 Include in appendices supplementary information that might be needed but which is too voluminous to put in the text for fear of interrupting the sequence of thought.

2.26.2 The following are typical information for appendices:

Amplifications of text discussions.

Flow charting of test methods.

Glossaries of special terms.

Lists of chemical or mathematical

symbols.

Detailed descriptions of apparatus of specialized nature.

Verification or calibration procedures.

Derivations of mathematical equations.

Charts and nomographs.

Report forms.

2.27 Flow Charting (Optional Appendix Item)

2.27.1 Flow Chart. A flow chart is not a replacement for a written test procedure, but is a diagram illustrating the flow and logic of any process, or system (i.e., test procedure, interlaboratory studies, etc.). It is a drawing made up of various, but specific, shapes of boxes connected by directional straight lines. Flow charting (1) gives a bird's-eye view of the flow and logic of a procedure in a pictorial fashion, (2) facilitates communication and understanding among individuals having different areas of expertise, (3) makes more obvious some of the strong and weak points of a system, (4) helps to generate ideas and provides a basis of discussion for improving a system, and (5) aids in the writing of new methods.

2.27.2 The box shapes of a proper flow chart are simple, but specific. The start and stop of a flow chart are denoted by a horizontal ellipse, with the appropriate word, START or STOP, within the ellipse. A process step, where no decision (yes or no) is required, is denoted by a rectangle. A process box usually has just one output arrow. If a decision is required, a diamond is used and two output arrows are required (yes or no). An example flow chart is as follows:

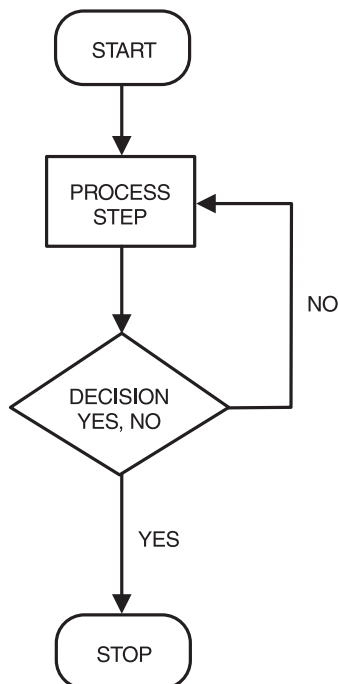

2.27.3 Flow charts should be used to illustrate major pieces of equipment, all inputs to processes (i.e., raw materials, utilities, etc.), all points where measurements are taken, and all points where adjustments can be made. The step number within the test method should be in the appropriate box or diamond of the flow chart.

3. The Manuscript

3.1 Purpose and Scope

3.1.1 Submit all manuscripts typed double space, in duplicate, on white paper of conventional weight. Leave a 2 in. left-hand margin and a 1 in. margin on the other 3 sides.

3.2 Designation of Colors

3.2.1 In presenting textile color data, use the method of color nomenclature developed by the Inter-Society Color Council and the National Bureau of Standards, commonly referred to as the ISCC-NBS method. See THE ISCC-NBS METHOD OF DESIGNATING COLORS AND DICTIONARY OF COLOR NAMES, K. L. Kelly and D. B. Judd, NBS Circular No. 553, U.S. Government Printing Office, 200 pp, Washington, D.C. (1955). Also STANDARDIZATION OF COLOR NAMES, Dorothy Nickerson, ASTM Standards on Textile Materials, p340 et seq., Philadelphia PA, 1940.

3.2.2 Identify colors by the three attributes of hue, lightness and chroma. Do not use the words shade, tint, depth of color and intensity. For example: rose and vermilion are hues of red, not tints or shades.

3.3 Units of Measurements

3.3.1 Use metric or SI units wherever feasible. Use English units only where they are the accepted trade practice.

3.3.2 Do not mix systems in one paragraph; for example, "a specimen 2 × 3 in. and weighing 2.0-2.5 g."

3.3.3 State measurements in both systems when both are in current American usage. Round off conversions to comparable accuracy. 1.0 in. becomes 2.5 cm, not 2.54 cm; but 1.00 in. is converted to 25.4 mm not 25 mm.

3.3.4 For liquid measure and for volumetric glassware, use milliliter (mL), not the obsolete (cc) cubic centimeter. For measures of capacity or volume, use the cubic centimeter, for which the accepted abbreviation is cm³.

3.3.5 Laboratory procedures require metric measurement and Celsius temperatures. Fahrenheit temperature is permissible for physical testing. Mill and dye-house practices govern units for process control, even if they are obsolescent, such

as Baumé, Twaddell, Brix and Rohmer in place of specific gravity hydrometers.

3.3.6 For cases when it is necessary to express measurements when range and accuracy must be included, say for example, weigh to within ± 0.001 g a specimen with weight in the range of 4-6 g.

3.4 Numbering

3.4.1 Use numbers instead of words in every case, unless confusion will ensue. Say "4 samples," "5 days," as well as to define exact quantities like "15.43 grams."

3.4.2 Designate tables by Roman numerals, and figures or drawings by Arabic numerals. Write Table IV not Table 4; Fig. 6 not Fig. VI.

3.4.3 Do not begin a sentence with a numeral.

3.4.4 Use decimal fractions.

3.4.5 Place a zero before decimal numbers to ensure that no digit has been omitted or misplaced. Write "0.36 cm," not ".36 cm."

3.4.6 Point off numbers in excess of 4 digits with commas in the text (1,234,567) but with spaces in tabulated material (1 234 567). Do not point off numbers of 4 digits except when they occur in columns containing numbers of more than 4 digits.

3.5 Spelling

3.5.1 In general, use the preferred spelling in the Merriam-Webster INTERNATIONAL DICTIONARY.

3.5.2 Use American forms, such as "color" not "colour," "liter" not "litre."

3.5.3 Hyphenate compound adjectives, particularly such forms as "2-gram specimens."

3.6 Punctuation

3.6.1 Use a comma in a series of words but not before a conjunction. Write "wash, dry and condition specimens." Always place commas and periods *inside* of quotation marks. Place semicolons and colons *outside* quotation marks.

3.7 Capital Letters

3.7.1 When in doubt, use lower case letters.

3.7.2 Capitalize the principal words in headings and titles of standards, names of books or papers. Use lower case for prepositions and conjunctions in titles.

3.7.3 Use initial capital "C" for "committee" when used as a title, but not when used as a collective noun. Say "Committee RA60" or "Committee on Industrial Pollution"; but "the committee recommends."

3.7.4 Use capital letters in referring to tables, figures, inserted plates and volumes; as: Table III, Fig. 2, Plate VI, Vol. 25.

3.8 Abbreviations

3.8.1 Use abbreviations in the singular number only. Say "2 in." not "2 ins." Exception: Abbreviations preceding numerical values, such as Figs. 1 and 2, Vols. I and II, Nos. 1 and 2.

3.8.2 Use abbreviations only after numbers denoting a definite quantity, except in tabulations. Do not say "mix rinse liquor in a *bbl.*" nor, "wash in H₂O."

3.8.3 Abbreviate "percentum" or "percent" with the symbol (%) which is far easier to read.

3.8.4 Do not use the symbol (#) to mean "pounds" or "number."

3.8.5 Put a period (.) after an abbreviation only when the omission would cause confusion. The principal examples are "in." not "in" for inches, "no." not "no" for number, "Fig." not "Fig" for figure, and "vol." not "vol" for volume.

3.8.6 A list of acceptable conventional abbreviations is shown in Appendix A.

3.8.7 Besides the conventional abbreviations, frequently repeated series of words may be abbreviated if the words are spelled out before the abbreviation at the first use. Examples: TNT (trinitrotoluene); BOD (biochemical oxygen demand); TCE (trichloroethylene).

3.8.8 Use chemical symbols only to represent chemical entities, never as abbreviations. Write "water" not H₂O unless water is used as a reagent. Write "rinse in water," not "rinse in H₂O; say "platinum crucible," not Pt crucible." Spell out the names of unusually complex or of uncommon organic or inorganic reagents if the chemical formula will waste space or obscure clarity of text. Write CuSO₄ · 5H₂O rather than cupric sulfate pentahydrate. Similarly, it is simpler to write "aspirin" than "acetylsalicylic acid" and certainly simpler than to write the structural formula.

3.8.9 Do not, as a general rule, abbreviate terms that are infrequently used without spelling out the entire word or phrase the first time the expression appears.

centimeter	cm
centipoise	cp
centistoke	cs
chemically pure (discontinued)	CP
coefficient of variation	%CV
Colour Index	C.I.
concentration	conc.
cubic centimeter	
(volume)	cm ³ (Note 2)
day	Spell out
degree	deg (Note 3)
diameter	diam
direct current (noun)	dc
(adjective)	d-c
equation	Eq
Fahrenheit	°F (Note 1)
figure	Fig.
foot	ft
foot-pound	ft-lb
formula weight	FW
gallon	gal
grain	gr
gram	g
horsepower	hp
hour	h
inch	in.
inside diameter	ID
Kelvin	K (Note 1)
kilocycle	kc
kilogram	kg
kilojoule	kJ
kilometer	km
kilovolt	kV
kilowatt	kW
kilowatt-hour	kW-h
linear	lin
liter	L
logarithm (common)	log
lux	lx
maximum	max.
meter	m
microamperes	μa
microgram	μg
microliter	μL
micromicron	μμ
micron (micrometer)	μm
microvolt	μV
microwatt	μW
mile	mi
miles per hour	mph
milliamperere	ma
milliequivalent	meq
milligram	mg
milliliter	mL (Note 2)
millimeter	mm
millivolt	mV
minimum	min.
minute	min (Note 4)
molal	<i>m</i> (Italic)
molar	<i>M</i> (Italic)
molecular weight	MW
nanometer	nm
normal	<i>N</i> (Italic)
number	No.
ohm	ohm
on weight of fiber	owf
ounce	oz
ounces per square yard	oz/sq yd
outside diameter	OD

Appendix A Abbreviations

absolute	abs
alternating current (noun)	ac
(adjective)	a-c
ampere	amp
A	A
angstrom unit	anhyd
anhydrous	anhyd
average	avg
barrel	bbl
Birmingham wire gage	Bwg
British thermal unit	Btu
Brown and Sharpe (gage)	B&S
calorie	cal
Celsius	°C (Note 1)
centigram	cg

page	p.	solution
pages	pp.	specific gravity
parts per billion	ppb	square
parts per million	ppm	standard deviation
per	Spell out or use solidus (/)	ton
percent	%	Twaddell
pint	pt	United States (wire gage)
pound	lb	United States Pharmacopeia
pounds per square foot	lb/sq ft	volt
pounds per square inch	psi	volume
quart	qt	watt
radian	rad	watt-hour
relative humidity	RH	week
revolutions per minute	rpm	yard
second	s	year

soln.
sp gr
sq
s
T
Tw
US
USP
V
vol.
W
W-h
wk
yd
yr

Notes

Note 1. Always use the abbreviation for the temperature scale °F, °C or K in statements of numerical temperatures, but omit the abbreviation “deg” for “degrees.” Write “69°F,” not “69 deg F.”

Note 2. Use the abbreviations “cm³” rather than “cc” as the unit of capacity. Use “mL” for milliliter” as the unit of volume.

Note 3. Restrict the use of the degree symbol (°) to °API, °BRIX, °Baumé, °Twaddell, °C, °F, °Rohmer and to degrees of angle or of arc.

Note 4. Spell out “minute” and “minimum” if there is any danger of confusion by use of the abbreviation “min.”

Rules of Procedure for AATCC Test Method and Technology Committees

Introduction

The Board of Directors is AATCC's governing body which administers its affairs under the provisions of the Constitution and Bylaws. AATCC Committees are responsible for nearly every phase of the Association's activities. Thus, the strength, vigor and authority of the Association are derived from the broad participation of its membership.

These Rules of Procedure are the responsibility of the Executive Committee on Research (ECR) which may amend or change items included after consultation with the Technical Committee on Research (TCR) and subject to the Board of Directors approval as long as they do not conflict with the AATCC Constitution or Bylaws.

A-Executive Committee on Research

A1—Function

A1.1 ECR is a standing committee of the Board of Directors. This Committee shall be responsible for establishing policy for, and programming of, all test method development and technical activities not specifically delegated to other special interest groups, subject to the Board of Directors approval.

A1.2 ECR directives for the execution of policy and program as approved by the Board of Directors are carried out through TCR.

A1.3 ECR has the responsibility to make sure that the test method development procedure follows the consensus principle and that any negative votes are fairly considered and resolved.

A1.4 ECR is the supervisory body within AATCC charged with the responsibility to attest that the necessary procedures have been followed and that the approval requirements set forth in these procedures have been met. The role of ECR in overseeing the development procedures and handling of negative votes at the committee level is covered in G1.1 through G1.4. Letter ballots of TCR are reviewed by a special Reviewing Committee consisting of the Chairs of ECR, TCR and the Test Method Committee concerned (G2).

A2—Organization

A2.1 The Chair of ECR is a member of the Board of Directors of the Association,

appointed annually by the Board of Directors. The Chair may not serve more than three years consecutively.

A2.2 The Chair of TCR becomes Vice-Chair of ECR.

A2.3 The President of the Association, immediate past president, president elect, Chairs of interest groups, Chair of the International Test Method Committee, Chair of the Education Advisory Board, Education Director and the Executive Director are members ex-officio.

A2.4 In addition, six senior members are appointed by the Board of Directors, two new appointments being made each year for terms of three years each.

A2.5 Members of ECR shall represent a broad spectrum of activities and interests and are appointed in a manner to maintain a balance of interest. No more than 50% of ECR shall represent any one interest area.

A2.6 The Laboratory Director serves as Secretary of ECR.

A3—Reports

A3.1 ECR reports to the Board of Directors through its Chair.

A3.2 In cooperation with the TCR Chair, the Chair of ECR prepares an annual report for publication in the AATCC TECHNICAL MANUAL.

B-Technical Committee on Research

B1—Function

B1.1 TCR is a subcommittee of ECR. It translates into action program and policy developed by ECR. It functions in an administrative and coordinating capacity and is responsible for directing the work of the Test Method, Technology, and Reference Committees.

B1.2 The Chair of TCR, subject to ECR approval, authorizes technical and research assignments to the AATCC Technical Center following requests for assistance by Test Method and Technology Committees.

B2—Organization

B2.1 The Chair of TCR is appointed annually by the Board of Directors after nomination by ECR. The Chair's term is limited to three consecutive years.

B2.1.1 Subject to the approval of ECR and the Board of Directors, the Chair nominates a Vice Chair and the members

of TCR.

B2.1.2 Regional Board Members, members of the Executive Committee on Research, and Chairs of the active Research Committees shall be ex officio members of TCR.

B2.1.3 Appointed members of TCR may serve up to five years; this term may be extended by majority vote of ECR.

B2.2 The Chair of TCR appoints, subject to ECR approval, members of Research Committees and Chairs of these committees after consulting with their members.

B2.3 The Laboratory Director serves as Secretary of TCR.

B3—Meetings and Reports

B3.1 TCR shall hold at least two meetings each year called by the Chair.

B3.2 TCR through its Chair reports its activities to ECR.

B3.3 In cooperation with the ECR Chair, the Chair of TCR prepares an annual report for publication in the TECHNICAL MANUAL by January 31 of each year.

C-Test Method Committees

C1—Function

C1.1 Test Method Committees are appointed to carry out specific technical projects leading to the establishment of AATCC Test Methods, the development of scientific data or the assembly of information for the benefit of the textile industry and in the public interest.

C2—Organization

C2.1 The organization of new committees or the development of proposed new test methods is announced in AATCC's publication, printed or electronic and other media of the press. Non-members as well as AATCC members are invited to participate in these activities. Non-members are given every opportunity to voice their opinion and are invited to become members and can subsequently have a voting interest. Non-members often provide the basis or request for a new test method to be developed.

C2.1.1 Members of a Test Method Committee are appointed by the Chair subject to the approval of the Chairs of TCR and ECR.

C2.1.2 Non-members may participate fully at the subcommittee (initial) stage

of test method development including interlaboratory tests and voting.

C2.1.3 A tentative completion date for development of any proposed new method must be set by the Test Method Committee and approved by ECR.

C2.2 Test Method Committee Chairs are appointed after the Chair of TCR has consulted with the Test Method Committee members concerned. Consultation may be by voice vote of members present at a regularly scheduled meeting or by letter ballot of all voting members. They must be Senior members of AATCC.

C2.2.1 The Chair of a Test Method Committee appoints the Chairs of its subcommittees.

C2.2.2 A Test Method Committee Chair may appoint a Steering Committee, subject to the approval of the Chair of TCR.

C2.2.3 A Test Method Committee Chair shall appoint a Secretary.

C3—Committee Officers

C3.1 Senior members of AATCC only may hold office in Test Method Committees and Subcommittees; i.e., Chair, Vice-Chair or Secretary.

C3.2 No member may be Chair of more than two active Research Committees at one time.

C3.3 A member may not serve as Chair of a Test Method Committee for more than three years consecutively, but may continue as a member.

C3.4 An ex-Chair may again become Chair after a lapse of one year.

C4—Voting

C4.1 Senior members of AATCC only may exercise a vote in AATCC Test Method Committees.

C4.2 Associate and non-members of the Association may serve as members of a Test Method Committee without vote.

C4.3 A Senior member may be a voting member of three active Test Method and three Technology Committees at the same time, but may serve on additional committees as a non-voting member. Exceptions to this may be granted by the Executive Committee on Research upon written petition from the member.

C4.4 Only one individual from any organization may be a voting member of any one test method committee. Other individuals from the same organization may participate in committee activities as non-voting members.

C5—Reports

C5.1 Following each committee meeting a Test Method Committee shall present a written report to TCR. The annual report may serve as a basis for the Committee's report in the AATCC TECHNICAL MANUAL. A copy of the annual re-

port should be forwarded to the Laboratory Director on or before January 31.

C6—Meetings

C6.1 Test Method Committee meetings shall be open to members of AATCC and non-members.

C6.2 The schedule of committee meetings shall be published in AATCC's journal and/or electronically such as on the web site.

C6.3 There shall be no registration fee for attendance to anyone (member or non-member) at these committee meetings.

C7—Publicity

C7.1 Members of the press may attend Test Method Committee meetings. They should be advised by the Chair, during the course of the meeting, that any deliberations or actions of the Committee shall not be published without clearance from the Chair, who should be guided by Association policy regarding publication of AATCC material.

Technical papers, committee reports and other documents and test methods are the property of the Association. They may not be published in full elsewhere unless written permission has been granted by the Association. Publication of Association material in other publications must give appropriate source and credit.

C8—Committee Actions

C8.1 Formal actions of a Test Method Committee shall be affirmed by letter ballot when requested by any voting member of a committee.

C9—Review of Test Methods

C9.1 A Test Method Committee shall review test methods under its jurisdiction every five years for the purpose of revision, reaffirmation or withdrawal. If a method is to be reaffirmed, reaffirmation shall be by majority approval of committee members or by a committee letter ballot followed by a TCR letter ballot. Such action must be initiated in the fourth year after approval so that final action may be concluded by the fifth year.

In cases where the Chair of a Reference Committee is no longer active or resigns from their duties in AATCC, Committee RA99, Technical Manual Editorial Review, in conjunction with the Laboratory Director, may appoint one or two experts who are knowledgeable in the area pertaining to a specific test method as reviewers of the method.

The reviewers shall recommend reaffirmation, revision or withdrawal of the method and shall initiate the appropriate TCR letter ballot.

C9.1.1 A new test method will be reviewed for reaffirmation each year for the first three years immediately following its publication through a TCR ballot.

C9.2 Workshops and seminars concerning AATCC test methods are available to non-members and members equally. At these programs, critical comments on AATCC test methods are brought to the attention of the responsible committees for their consideration and action.

D—Duties of a Test Method Committee's Chair

D1—Responsibility

D1.1 The Chair of a Test Method Committee is responsible for the operation of that Committee.

D2—Meetings

D2.1 The Chair shall call such meetings as are necessary and see that the committee's work proceeds as planned.

D2.2 In general, meetings are scheduled in conjunction with meetings of TCR in order that the latest activities of the Test Method Committee may be reported. However, the Chair may call additional meetings at the Chair's discretion.

D3—Personnel

D3.1 The Chair appoints members of a Test Method Committee, subject to the approval of the Chairs of TCR and ECR.

D3.2 Every effort is made to have a balance of voting interests on each committee in order to develop test methods according to the consensus principle.

D3.3 If a member of a Test Method Committee resigns or is unable to take an active part in the work of the Committee and is dropped the Chair shall notify the Chair of TCR and the Laboratory Director.

D3.4 A voting member who is absent from *four* consecutive meetings of a Test Method Committee or does not participate in any of its activities shall be dropped from the committee's membership rolls. Failure to return ballots is defined as a lack of participation in a committee activity. A terminated member may appeal to ECR for reinstatement if the member demonstrates satisfactory reasons for the inactivity. Membership voting rights can also be terminated by non-payment of annual Association dues.

D4—Test Methods—Changes and Revisions

D4.1 A Chair on behalf of their Committee makes such recommendations for changes and revisions in test methods as are required and reports them to the Chair

of TCR, who will in turn, submit these recommendations to ECR. Subject to ECR approval these recommendations for changes or revisions shall be referred to TCR for letter ballot.

D5—Financing

D5.1 Each calendar year Test Method Committees will be contacted regarding their possible needs for funds to be made available at the beginning of the fiscal year, August first.

D5.2 Should a committee require special funds not included in the annual budget for its work, the Chair should make application to the Chair of TCR who will submit the request to ECR with a recommendation. Should there be contingent provision in the existing budget to cover such expenditures, ECR may authorize the funds. Otherwise, ECR, on approval will request an authorization for expenditures from the Appropriations Committee, which, in turn, will submit the request to the Board of Directors.

D6—Requests for Assistance from AATCC Technical Center

D6.1 Technical and administrative assistance from the AATCC Technical Center, required for committee operations, should be requested by the Test Method Committee Chair from the Chair of TCR. The Chair of TCR, in consultation with ECR and Senior Staff, will determine if the work requested can be undertaken within the existing budget and program facilities available.

E-Duties of a Test Method Committee's Secretary

E1—Minutes and Records

E 1.1 The Secretary shall keep accurate minutes of all meetings and records of all test method developments of the Committee.

E1.1.1 Minutes prepared for distribution should contain on the first page the legend "**Committee Document—Not for Publication.**"

E1.2 Minutes shall be circulated at an early date after a meeting. Copies shall be sent to the AATCC Technical Center, all committee members, the Chair of TCR, the Laboratory Director, and any other desired information addresses.

E1.3 The Secretary shall keep records of attendance at meetings.

E2—Correspondence and Reports

E2.1 At the direction of the Chair, the Secretary shall carry on such correspondence and prepare such reports as are required by the Committee.

F-Procedure for Establishing Methods of Test

F1—Need and Feasibility

F1.1 Proposals for the development of new test methods may be made by members or non-members of AATCC. They are brought to the attention of the Chair of TCR who in consultation with members of ECR determines whether the development of a proposed new method is feasible through an existing Test Method Committee. If the organization of a new committee is necessary, ECR may approve an announcement in AATCC's publication inviting members and non-members of AATCC to participate in an exploratory meeting to determine general interest in the subject. If there is sufficient interest, ECR may approve the establishment of a new committee that will function as indicated under Section C.

F2—Development Procedure

F2.1 A subcommittee which may include non-members of AATCC is organized to study available background information and to conduct interlaboratory tests according to a suitable statistical design. When the subcommittee has developed a test method which is considered reproducible and technically valid it is submitted along with all data available to the full Test Method Committee.

F2.2 A letter ballot of the Test Method Committee is conducted on the proposed test method according to G1. Upon receipt of an affirmative vote and evidence of consideration of all negative votes, a letter ballot of TCR is conducted on a proposed test method according to G2. The results are reported to ECR for final action.

F3—Designation and Publication

F3.1 ECR gives final approval or denial on a proposed test method on the basis that all substantially concerned persons have had an opportunity to express their views and that these views shall have been considered; also, that there is evidence of the technical validity of the proposed test method.

F3.2 Following confirmation by ECR a new test method is officially designated and published as soon as practical in the AATCC TECHNICAL MANUAL and in other AATCC publications when appropriate.

G-Letter Ballots

G1—Committee Letter Ballots

G1.1 A majority of members present at a meeting of a Test Method Committee may vote to send a new test method or revision of an existing test method to a let-

ter ballot of the entire Committee. Before requesting a letter ballot, however, those committee members present at the meeting should assure themselves that the new method or revision of an existing method is in prescribed form and that sufficient data are in hand to support the method or revision. All members of a Test Method Committee, both voting and non-voting, shall receive copies of all letter ballots issued by the Committee. Nonvoting members as well as voting members of the Committee may submit in writing any comments which they deem appropriate concerning the proposed test method or revision. To be counted, all letter ballots must be received by the committee concerned within 30 days of the mailing date. A ballot is considered valid when, of the voting members sent ballots, the number of ballots returned is equal to, or greater than, 50% of the mailing plus one ballot.

G1.2 If there are no negative votes on the ballot it would progress to a TCR letter ballot. If there are negatives then refer to Section G3.

G2—TCR Letter Ballots

G2.1 Once a committee letter ballot has been approved within the committee then it will progress to a TCR letter ballot. The ballot will be sent to all members of TCR. To be counted, all letter ballots must be received by the committee concerned within 30 days of the mailing date. A ballot is considered valid when, of the voting members receiving ballots, the number of ballots returned is equal to, or greater than, 50% of the mailing plus one ballot.

G2.2 If there is no negative votes on the ballot then it would be reviewed by ECR for publication in the next edition of the AATCC TECHNICAL MANUAL. If there are negatives refer to G3.

G3—Negatives on Ballots

G3.1 Within 60 days after the closing date for the Committee or TCR letter ballots the Chair of the Test Method Committee shall attempt to resolve any negative votes or comments, either personally or by a subcommittee which the Chair may appoint. If at the end of the 60 day period there are still unresolved negative votes, the Chair of the Committee shall forward to the Chair of TCR the matter on which the ballot was taken, copies of unresolved negative votes with accompanying supporting comments, a summary of attempts to resolve the negative votes, and background data and actions which led to the ballot.

G3.2 The Chair of TCR shall present the material provided by the Committee Chair to ECR for decision at its next regular meeting. Copies of the material shall

be distributed to members of ECR prior to the meetings or as early as possible to facilitate thorough study and consideration.

G3.3 After studying the ballot and the background information provided, ECR shall take one of the following actions.

G3.3.1 Return the matter to the Test Method Committee for further work and another ballot if ECR decides that material and data submitted are insufficient to justify the action taken by the Test Method Committee.

G3.3.2 Approve a TCR letter ballot on the basis of the Test Method Committee majority or approve the publication on the basis of TCR majority if ECR reasons that the unresolved negative votes and comments are not persuasive and do not justify further investigation.

G3.4 Should the Test Method Committee recommend that a revision of the questions be put to letter ballot, a new ballot shall be circulated, and again, until no material objections exist.

G3.5 Resolution of all negative ballots must be recorded.

G4—Disqualifications and Challenges

G4.1 Members of ECR and the Board of Directors shall disqualify themselves when appeals are made on test methods if they or a member of their immediate family have financial interest in or other close relationship with any of the parties (or with the subject matter) that would make it inappropriate for them to participate in the consideration and decision of any appeal. All parties to an appeal shall have the right to challenge the qualification of the appeals board members, with justification based on the above stated reasons, at least one week prior to consideration of an appeal by ECR or the Board of Directors who are disqualified from a specific appeal shall absent themselves from the argument, deliberations and decisions.

H—Correspondence and Records

H1—Copies

H1.1 Copies of all correspondence, reports and research records should be forwarded to the Chair of TCR and the Laboratory Director in addition to any other desired information addresses.

H2—Files

H2.1 Test Method Committee files in the hands of Chairs and Secretaries shall be turned over promptly to their successors. The files that are no longer active but are of historical value and interest should be forwarded to the AATCC Technical Center for permanent record.

I—Reference Committees

I1—Function

I1.1 When a Test Method Committee has completed its assignment, it may assume an inactive status and function as a Reference Committee with approval of TCR and ECR.

I2—Organization

I2.1 The Chair of the Test Method Committee shall continue as Chair of the Reference Committee. The Chair shall continue the responsibilities of the committee in terms of reviewing methods requiring reaffirmation. If changes to the method are necessary the Chair should reactivate the committee.

I2.1.1 The Chair may retain such members of the Test Method Committee as he deems advisable, otherwise, the remainder of the committee is dissolved. Should a Reference Committee be reactivated, the Chair shall act as temporary Chair until the committee is reorganized.

I2.2 After its first meeting, a reactivated Test Method Committee shall submit to the Chair of TCR its recommendations for Chair.

I3—Review of Test Methods

I3.1 Reference Committees shall follow the same review procedure for test methods as active Research Committees (see C9).

I3.2 In cases where the Chair of a Reference Committee is no longer active in AATCC, see C9.1.

J—Technology Committees

J1—Scope

J1.1 To coordinate and direct the planning of technical programs of special interest to individuals and groups concerned with technology subjects; to recommend and encourage presentation of these programs as a part of the regular program of technical papers, and to promote in every way increased interest and attendance at the technical sessions of AATCC.

J1.2 To encourage and promote active participation in the research and test method development programs of the Association by members whose primary interest is in the technology subject in order that problems in that area of technology may be part of the program of research of the Association.

J1.3 To act as a clearinghouse for information on the technology subject for members of AATCC.

J1.4 To develop a consensus by polling AATCC members whose primary interest is in the field of the technology subject.

J1.5 To promote the interests of the Association whenever the opportunity may arise in accordance with the Committee's objectives.

J1.6 To encourage and solicit membership in the Association on the part of individuals interested in the technology subject.

J2—Organization

J2.1 Members of a Technology Committee are appointed by the Chair subject to the approval of the Chair of TCR and ECR. Members of the Committee shall be selected to provide representation from all Sections of AATCC which have sufficient interest in the technology subject.

J2.2 The Committee shall have a Chair, and may have a Vice-Chair. The names of the individuals to be recommended to the Chair of TCR for appointment to these offices, subject to the approval of ECR, shall be determined by vote of the Technology Committee and submitted to the Chair of TCR.

J2.2.1 A Chair of a Technology Committee shall appoint a Secretary from the membership of the Committee.

J2.2.2 A Chair of a Technology Committee shall appoint the Chair of such subcommittees as are necessary to carry out its program.

J2.2.3 A Chair of a Technology Committee may appoint a Steering Committee, subject of the approval of the Chair of TCR.

J2.2.4 A Chair of a Technology Committee may not serve in that capacity for more than three years consecutively, but may continue as a member of the Committee. An ex-Chair may again become Chair after a lapse of one year.

J2.3 Only Senior members of AATCC may hold office in Technology Committees and subcommittees, and Senior members only may exercise a vote. Associate members may serve without vote on a Technology Committee. No more than one member of an organization may be a voting member of any one Technology Committee.

J3—Committee Actions

J3.1 Formal actions of a Technology Committee shall be affirmed by letter ballot when requested by any voting member of the committee. Procedures for balloting including resolution of negatives shall be the same as test method committees.

J4—Meetings

J4.1 A Technology Committee shall call such meetings as are necessary and see that the committee's work proceeds as planned.

J5—Reports

J5.1 Following each committee meeting a Technology Committee shall send a written report to the Chair of TCR and the Laboratory Director. A Technology Committee shall submit an annual report to TCR. A report shall serve as a basis for the Committee's report to be published in the TECHNICAL MANUAL. A copy of the annual report should be forwarded to the AATCC Technical Center for publication purposes.

J6—Publicity

J6.1 A Technology Committee shall publish announcements of its meetings and activities in the Association's publication.

J6.2 The Committee shall maintain an up-to-date mailing list of both members of AATCC and prospective members who are interested in the technology subject, and shall advise such interested individuals regarding AATCC technical sessions where papers on the technology subject will be presented; notify such interested individuals by mail of the Committee members who can be contacted for information or help in problems of the technology subject; and solicit from such individuals recommendations for membership on the Technology Committee.

J6.3 The interested Sections of AATCC will be encouraged to include in their Sectional or Program Committees, a member of that Section who is a member of the Technology Committee, in order that the officers of the Section may be kept informed of the work of the Technology Committee and the availability of technical programs of interest to the members of the Section concerned with the technology subject.

J6.4 Technical papers, committee reports and other committee documents are the property of the Association. They may not be published in full elsewhere until they have appeared in AATCC's publication or unless permission has been granted by the AATCC. Publication of Association material in other publications must give appropriate source and credit. For publicity purposes, when immediate release of news is desirable, abstracts, digests, summaries of reports must be lim-

ited to 500 words or less, unless written permission is granted by the Association.

J7—Financing

J7.1 Each calendar year Technology Committees will be contacted regarding their possible needs for funds to be made available at the beginning of the fiscal year, August first.

J7.2 Should a Committee require special funds not included in the annual budget for its work, the Chair should make application to the Chair of TCR who will submit the request to ECR with a recommendation. Should there be contingent provision in the existing budget to cover such expenditures, ECR on approval will request through the Board of Directors an authorization for expenditures from the Appropriations Committee.

K-AATCC Technical Center

K1—Function

K1.1 The AATCC Technical Center furnishes supporting services, through its staff and laboratory facilities, to the Association's committees.

K1.2 The functions of the laboratory at the AATCC Technical Center are as follows:

a. To serve as a bureau of standards for test methods, a place where AATCC methods can be run according to every detail of the test procedure as outlined.

b. To serve as a proving ground for test methods developed by various test method committees of AATCC. In doing so, the test methods will be conducted and the results analyzed statistically to make sure that they are reproducible in every sense.

c. To serve as a focal point in the organization as a site for demonstrating and developing test methods, for conducting workshops and seminars for the education of our members and industry at large.

d. To serve as a place in which test equipment necessary to conduct many AATCC test methods is on exhibit as well as a central location for equipment which might be of interest to AATCC members.

K2—Organization

K2.1 The AATCC Technical Center located in the Research Triangle Park of North Carolina provides a permanent organizational structure for the Association.

K2.2 The Executive Director is responsible for the overall management of the AATCC Technical Center.

K2.3 The Laboratory Director supervises the technical and research assignments authorized by ECR.

K3—Clearance of Assignments

K3.1 No assignment can be accepted by the AATCC Technical Center unless it has been approved by ECR. The AATCC Technical Center operations are intended to supplement and support AATCC Committees through preplanned co-ordination in an effort to provide maximum service within the limitations of the budget.

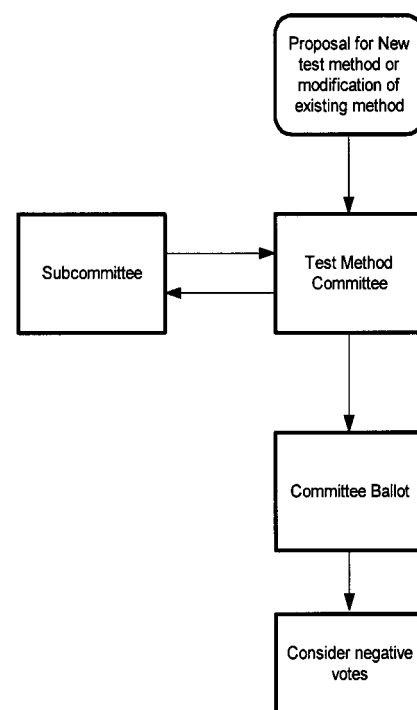

(See Fig. 1b)

Fig. 1a—AATCC Test Method Development.

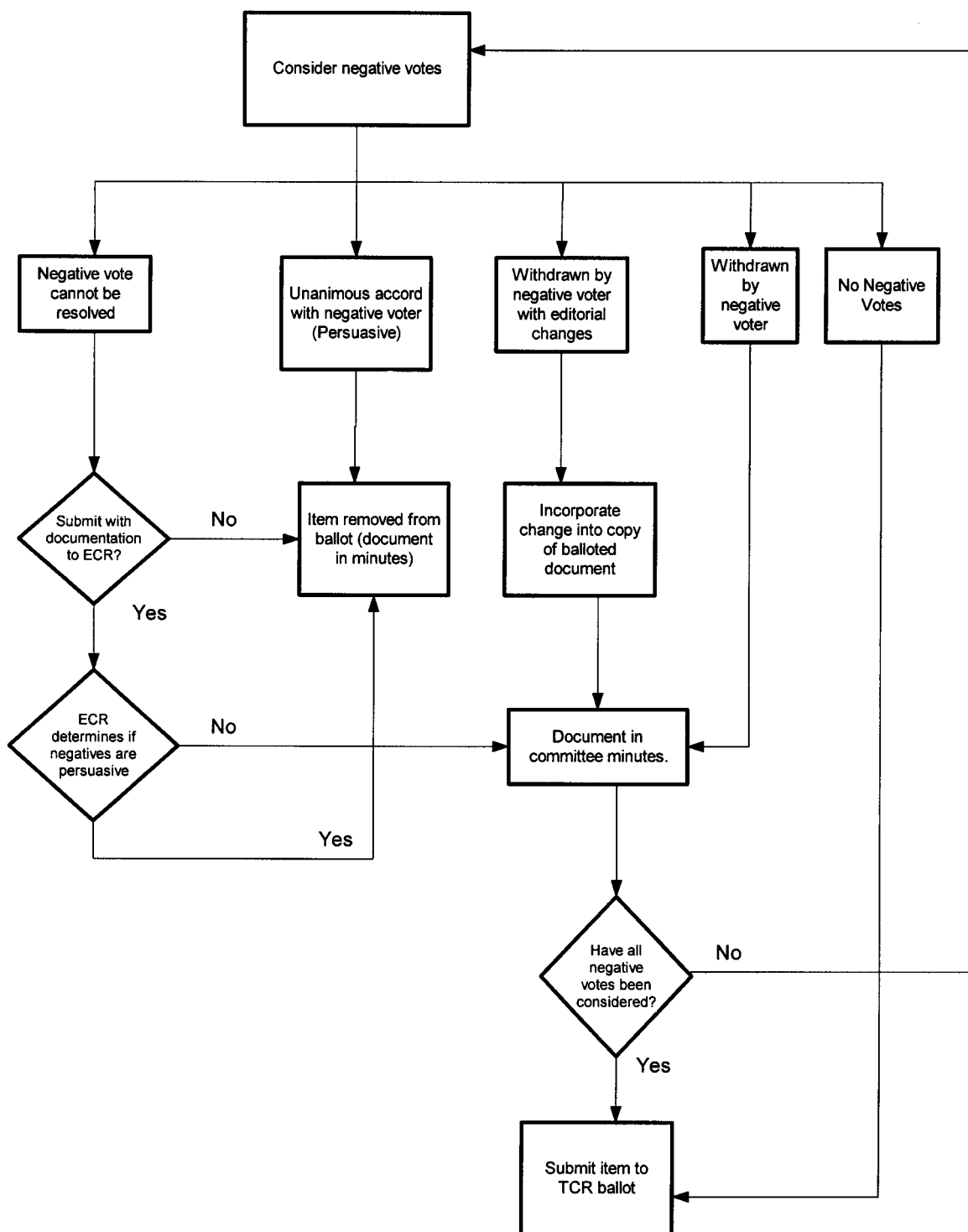

(See Fig. 1c)

Fig. 1b—AATCC Test Method Development.

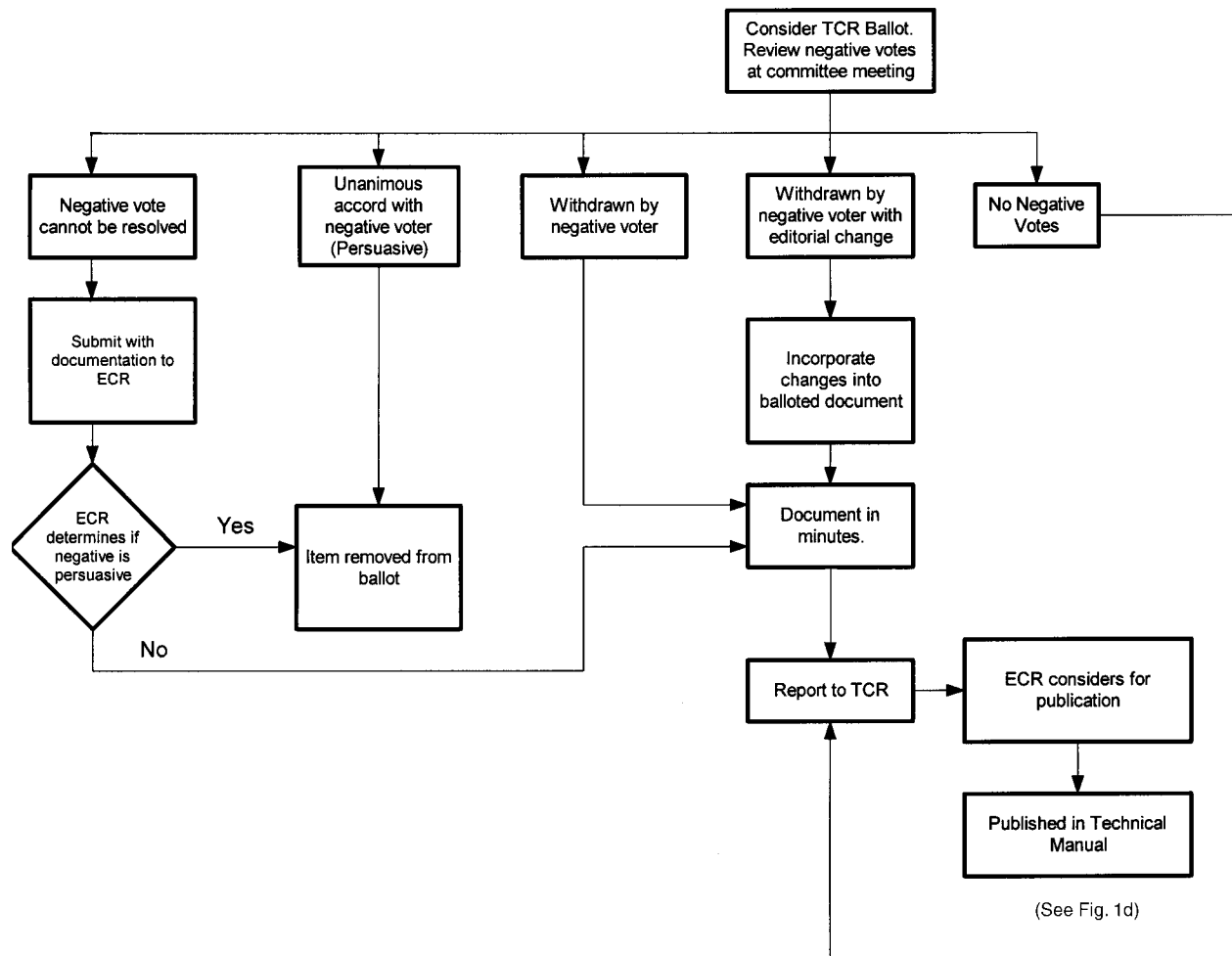

Fig. 1c—AATCC Test Method Development.

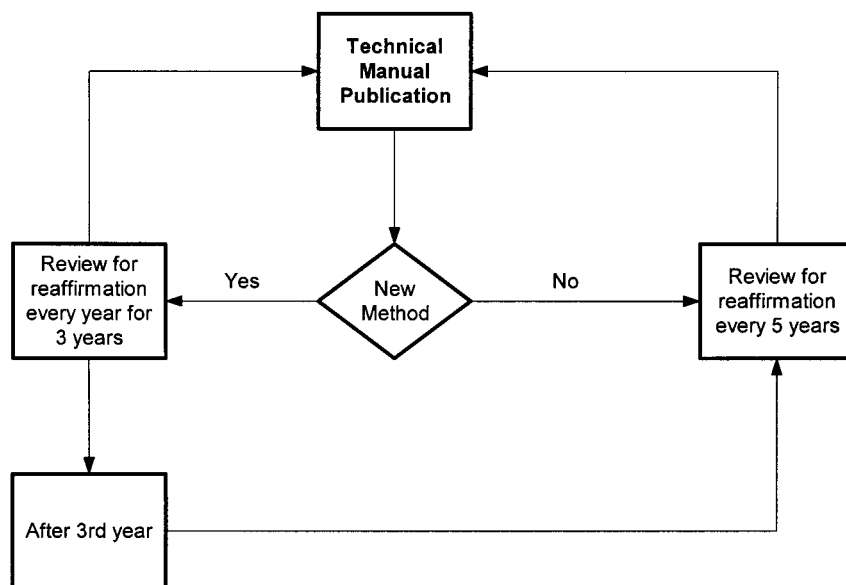

Fig. 1d—AATCC Test Method Development.

AATCC Administrative Committees for 2005

Board of Directors (with contact information)..... 438

Appropriations	440	Employee Benefits	439
Awards Oversight.....	439	Executive Committee on Research.....	439
Board of Directors.....	438	International Test Methods.....	439
Building and Grounds	439	Membership Committee.....	440
Chairs of Administrative Committees.....	438	Millson Award.....	441
Chapin Award	440	Olney Medal.....	441
Colour Index	440	Past Presidents (living)	441
Conferences	440	Publications.....	440
Constitution and Bylaws	440	Technical Committee on Research	439
Educational Advisory Board	440	Textile Education	440

AATCC Interest Groups

Chemical Applications	441
Concept 2 Consumer	441
Materials	441

AATCC Board of Directors and Administrative Committees

AATCC Board of Directors for 2005

The AATCC Board of Directors consists of the President, President-Elect, Immediate Past President, Interest Group Chairs, one At-Large Member from each of the Interest Groups, the Executive Director (non-voting), the Treasurer, the chair of the Executive Committee on Research, the chair of the Publications Committee, the chair of the Education Advisory Committee, and the Regional Board Members. By virtue of the AATCC Constitution (Article V), the president-elect is elected to serve for a two-year term, after which time the individual automatically moves to serve as president for a two-year term, and the current president automatically becomes the immediate past president for a two-year term. The date shown following a Board Members' name indicates the beginning year of the first term as a member.

President

ROBERT K LATTIE '05
SDL Atlas LLC
Textile Test Products Div
4114 N Ravenswood Ave
Chicago IL 60613-1786
Phone: (773) 289-5570
Fax: (773) 327-4023
E-Mail: rlatie@sdlatlas.com

President-Elect

MARTIN J BIDE '05
University of Rhode Island
Dept of Textiles
311 Quinn Hall
Kingston RI 02881
Phone: (401) 874-2276
Fax: (401) 874-2581
E-Mail: mbide@uri.edu

Immediate Past President

ROLAND L CONNELLY SR '05
GretagMacBeth
1108 Greccade St
Greensboro NC 27408-8729
Phone: (336) 274-1963
Fax: (336) 274-1971
E-Mail: Connelly@
gretagmacbeth.com

Executive Director

JOHN Y DANIELS
AATCC
PO Box 12215
Research Triangle Park NC
27709-2215
Phone: (919) 549-2522
Fax: (919) 549-8933
E-Mail: danielsj@aatcc.org

Treasurer

CHARLES E GAVIN III '03
MFG Chemical Inc
6701 Highway 64 E
Wartrace TN 37183-3056
Phone: (706) 226-4114
Fax: (706) 275-6044
E-Mail: gavn3@aol.com

Central Atlantic Regional Board Member

KANTI A JASANI '05
Guilford Mills Inc
PO Box 248
Pine Grove PA 17963-0248
Phone: (570) 345-2611
x5412
Fax: (570) 345-2311
E-Mail: kjasani@gfd.com

International Regional Board Member

JAYAKUMAR
GOPALAKRISHNAN '05
Global Resources
Management Group
358 North Main Rd
Annanagar West
Madras 600101 INDIA
Phone: (91) 98400 59859
Fax: (91) 44261 51792
E-Mail: jayakumar@
grmg.org

Midsouth Regional Board Member

ROBERT FREDERICK
MILLER JR '05
Hickory Yarns
PO Box 1975
Hickory NC 28603-1975
Phone: (828) 322-1550 x1
Fax: (828) 322-1627
E-Mail: freddymiller@
hickoryyarns.com

Midwest Regional Board Member

ROY J BAMFORD '05
Aurora Textile Finishing Co
PO Box 70
Aurora IL 60507-0070
Phone: (630) 892-7651
x267
Fax: (630) 892-3215
E-Mail: rbam@
auroratextile.com

New England Regional Board Member

HEIDI WOODACRE '05
Talbots
1 Talbots Dr
Hingham MA 02043-1583
Phone: (781) 741-7549
Fax: (781) 741-4959
E-Mail: heidi.woodacre@
talbots.com

Southern Regional Board Member

REMBERT J TRUESDALE III '05
Southern Mills Inc
1683 Lawrence Rd
Molena GA 30258-3921
Phone: (706) 647-2007
Fax: (706) 647-1337
E-Mail: bertt@
southernmills.com

Chemical Applications Interest Group Chair

STEPHEN B BROOKS '05
National Textiles
PO Box 1580
Winston-Salem NC 27102-1580
Phone: (336) 714-8561
Fax: (336) 714-8783
E-Mail: steve.brooks@
nationaltextiles.com

Chemical Applications Interest Group Member at Large

RANDALL A COX '05
Boehme Filatex Inc
209 Watlington Industrial Dr
Reidsville NC 27320-8147
Phone: (336) 634-3353
E-Mail: rcx@
boehmefilatex.com

Concept 2 Consumer Interest Group Chair

JOHN A DARSEY JR '05
Color Solutions
International
9844-A Southern Pines
Blvd
Charlotte NC 28273-5561
Phone: (704) 561-2929
Fax: (704) 561-2915
E-Mail: darsey.john@
colorolutions
international.com

Concept 2 Consumer Interest Group Member at Large

KAREN E KYLLO '05
Intertek
70 Diamond Rd
Springfield NJ 07081-3119
Phone: (973) 924-2507
Fax: (973) 379-5232
E-Mail: karen.kyllo@
intertek.com

Materials Interest Group Chair

FRED L COOK '05
Georgia Inst of Technology
School of Polymer Text &
Fiber Eng
801 Ferst Dr
Atlanta GA 30332-0001
Phone: (404) 894-2536
Fax: (404) 894-8780
E-Mail: fred.cook@
ptfe.gatech.edu

Materials Interest Group Member at Large

MARCIA L QUINLAN '05
Albany International
Techniweave Inc
PO Box 9114
Mansfield MA 02048-9114
Phone: (508) 337-9528
Fax: (508) 339-4996
E-Mail: macia_quinlan@
albint.com

Education Advisory Board Chair

NELSON E HOUSER '05
M Dohmen USA Inc
PO Box 111
Burlington NC 27216-0111
Phone: (336) 584-0111
Fax: (336) 584-3548
E-Mail: nhouser@
burco.com

Executive Committee on Research Chair

RICHARD A
MALACHOWSKI '04
Cranston Print Works Co
2 Worcester Rd
Webster MA 01570-1652
Phone: (508) 943-0520
Fax: (508) 943-3468
E-Mail: rmalachowski@
cpw.com

Publications Committee Chair

KEITH R BECK '05
NC State University
Textile Eng Chem &
Science
2401 Research Dr
Raleigh NC 27695-0001
Phone: (919) 515-6558
Fax: (919) 515-6532
E-Mail: keith_beck@
ncsu.edu

Administrative Committees for 2005

Chair of Administrative Committees

Chairs of AATCC Administrative Committees are appointed annually and may not serve more than five years consecutively except at the discretion of the Board of Directors (AATCC Bylaws, Article IV, Section 13). The date shown following a chair's name in the committee rosters below indicate the beginning year of his first term as chair.

SPECIAL COMMITTEES

Harold C. Chapin Award Committee
JIMM C BARBERY '05
Apollo Chemical Co

Henry E. Millson Award for Invention Comm
FRED L COOK '05
Georgia Inst of Tech

Olney Medal Award Committee
PETER J HAUSER '05
NC State Univ

STANDING COMMITTEES

AATCC Board of Directors
ROBERT K LATTIE '05
SDL Atlas LLC

Appropriations Committee
ROLAND L CONNELLY
SR '05
GretagMacBeth LLC

Committee on Conferences
BRIAN C FRANCOIS '05
Cognis Corp

Constitution & Bylaws Committee
FRED L COOK '05
Georgia Inst of Tech

Education Advisory Board
NELSON E HOUSER '05
M Dohmen USA Inc

Executive Committee on Research
RICHARD A
MALACHOWSKI '04
Cranston Print Works Co

Individual Membership Committee
ROBERT FREDERICK
MILLER JR '03
Hickory Yarns

Publications Committee
KEITH R BECK '05
NC State Univ

Technical Committee on Research
RICHARD S SIMONSON
'04
Burlington Ind

Textile Education Committee
IAN R HARDIN '03
Univ of Georgia

C1 Board of Directors

Chair

ROBERT K LATTIE
SDL Atlas LLC

ROY J BAMFORD†
Aurora Textile Finishing
Co

KEITH R BECK†
NC State Univ

MARTIN J BIDE†
Univ of Rhode Island

STEPHEN B BROOKS†
National Textiles

ROLAND L CONNELLY
SR†
GretagMacbeth LLC

FRED L COOK†
Georgia Inst of Tech

RANDALL A COX†
Boehme Filatex Inc

Secretary

JOHN Y DANIELS
AATCC

JOHN A DARSEY JR†
Color Solutions Int'l
CHARLES E GAVIN III†
MFG Chem Inc

JAYAKUMAR
GOPALAKRISHNAN†
Global Resources
Management Grp

NELSON E HOUSER†
M Dohmen USA Inc
KANTI A JASANI†
Guilford Mills Inc

KAREN E KYLLO†
Intertek

RICHARD A
MALACHOWSKI†
Cranston Print Works Co

ROBERT FREDERICK
MILLER JR†
Hickory Yarns

MARCIA L QUINLAN†
Albany Int'l Techniweave
Inc

REMBERT J TRUESDALE
III†
Southern Mills Inc

HEIDI WOODACRE†
Talbots

* Nonvoting
† Ex Officio
‡ Nonmember AATCC

Subcommittee of the Board of Directors

C1-S8 Building and Grounds Committee

Chair
CHARLES E GAVIN III
MFG Chem Inc

Secretary
JOHN Y DANIELS
AATCC

MARTIN J BIDE†
Univ of Rhode Island

ROLAND L CONNELLY
SR
GrettagMacbeth LLC

FRED L COOK
Georgia Inst of Tech

JOHN A DARSEY JR
Color Solutions Int'l

NELSON E HOUSER
M Dohmen USA Inc

ROBERT K LATTIE†
SDL Atlas LLC

ROBERT FREDERICK
MILLER JR
Hickory Yarns

WARREN S PERKINS

C1-S14 Employee Benefits Committee

Chair
JOHN A DARSEY JR
Color Solutions Int'l

Secretary
JOHN Y DANIELS
AATCC

ROY J BAMFORD
Aurora Textile Finishing
Co

MARTIN J BIDE†
Univ of Rhode Island

ROLAND L CONNELLY
SR†
GrettagMacbeth LLC

CHARLES E GAVIN III†
MFG Chem Inc

NELSON E HOUSER†
M Dohmen USA Inc

ROBERT K LATTIE†
SDL Atlas LLC

C1-S16 Awards Oversight Committee

Chair
ROBERT K LATTIE
SDL Atlas LLC

Secretary
PEGGY J PICKETT
AATCC

JIMM C BARBERY†
Apollo Chem Co

MARTIN J BIDE†
Univ of Rhode Island

FRED L COOK†
Georgia Inst of Tech

IAN R HARDIN†
Univ of Georgia

PETER J HAUSER†
NC State Univ

C2 Executive Committee on Research

Chair
RICHARD A MALACHOWSKI
Cranston Print Works Co

Vice Chair
RICHARD S SIMONSON
Burlington Ind

Secretary
AMY G HAMMONDS
AATCC

MARTIN J BIDE†
Univ of Rhode Island

STEPHEN B BROOKS†
National Textiles

KENNETH R BUTTS
Datacolor

ROLAND L CONNELLY
SR†
GrettagMacbeth LLC

FRED L COOK†
Georgia Inst of Tech

JOHN Y DANIELS†
AATCC

JOHN A DARSEY JR†
Color Solutions Int'l

ELIZABETH A EGGERT*
Procter & Gamble

IAN R HARDIN
Univ of Georgia

NELSON E HOUSER†
M Dohmen USA Inc

NORMA M KEYES
Cotton Inc

ROBERT K LATTIE†
SDL Atlas LLC

GARY C LICKFIELD
Clemson Univ

PEGGY J PICKETT†
AATCC

LOUANN SPIRITO
SGS US Testing Co Inc

NODIE M WASHINGTON
Procter & Gamble

Subcommittee of the Executive Committee on Research

C2-S1 International Test Methods

Note: Chairs of pertinent technical committees and AATCC spokesman for ISO/TC 38 subcommittees and working groups are members ex officio.

Chair
ROBERT K LATTIE
SDL Atlas LLC

Secretary
AMY G HAMMONDS
AATCC

JESSICA ANN
Milliken & Co

PATRICK J BRENNAN
Q-Panel Lab Products

ADI B CHEHNA
Textile Tech Servs

ROLAND L CONNELLY
SR
GrettagMacbeth LLC

JOHN Y DANIELS†
AATCC

STEPHEN L FOWLER
Fowler Assoc Inc

FRANK A FUSS
MeadWestvaco Corp

ROBB R GARDNER
Procter & Gamble

GREGORY D GEORGE
Innovative Chem
Technologies Inc

CAROL GRAHAM
James H Heal & Co Ltd

RICHARD W HAROLD†
Color and Appearance
Consulting LLC

DAVID HINKS
NC State Univ

NANCY E HOBBS†
Town & Country Living

NORMA M KEYES
Cotton Inc

BILL KIMBRELL
Milliken & Co

ROLF G KUEHNI

KAREN E KYLLO
Intertek

ANGELA B MASSENGILL
Cotton Inc

JAMIE E MOAK
Procter & Gamble

LUTHER M MYERS
Textile Innovators Corp

NANCY E PEBENITO
Nike

THOMAS H PERRY JR
Dow Chem Co

CHARLES L RIGGS
Texas Woman's Univ

ADRIENNE M RYBAK
Int'l Fabricare Inst

LUISA D SANTOS
US Army Natick Soldier
Center

FERNAND SCHLAEPPI

* Nonvoting
† Ex Officio
‡ Nonmember AATCC

RICHARD S SIMONSON
Burlington Ind

RICHARD SLOMKO
Atlas Weathering Svs Grp

ADAM R VARLEY
Vartest Int'l Inc

JOAN B WARD

NODIE M WASHINGTON
Procter & Gamble

ANN E WEAVER‡
3M Co-Safety & Security
Systems

MANFRED WENTZ
Textile Care Int'l (TCI) Ltd

C3 Technical Committee on Research

In addition to the appointed members of the committee, regional board members, chairs of research committees, chairs of interest groups and members of the Executive Committee on Research are shown as ex officio members of the Technical Committee on Research.

Chair
RICHARD S SIMONSON
Burlington Ind

Vice Chair
ELIZABETH A EGGERT
Procter & Gamble

Secretary
AMY G HAMMONDS
AATCC

NIKHIL AGRAWAL
Unilever HPC USA

F POWELL ANDREWS
III†
Dillard's Store Services

MARY D ANKENY†
Cotton Inc

JESSICA ANN†
Milliken & Co

J RICHARD ASPLAND
Clemson Univ

BENNETT R BAIRD
Material Science &
Innovation LLC

ROY J BAMFORD†
Aurora Textile Finishing
Co

RICHARD A
BARNHARDT†
Apollo Chem Corp

KEITH R BECK
NC State Univ

MARTIN J BIDE†
Univ of Rhode Island

HENRY A BOYTER JR†
Inst of Textile Tech

PATRICK J BRENNAN
Q-Panel Lab Products

STEPHEN B BROOKS†
National Textiles

RICHARD O BROWN
BGB Stockhausen

THOMAS J BURNS†
Clariant Corp

KENNETH R BUTTS
Datacolor

ADI B CHEHNA†
Textile Tech Services

ROBERT B CLEAVER

BILLIE J COLLIER
Univ of Tennessee

MICHAEL E COMPTON†
DuPont Ink Jet

ROLAND L CONNELLY
SR†
GrettagMacbeth LLC

FRED L COOK†
Georgia Inst of Tech

ALAN D CORRELL
National Spinning Co

THOMAS C COX
Amitech

JOHN Y DANIELS†
AATCC

JOHN A DARSEY JR†
Color Solutions Int'l

MICHAEL J DREWS†
Clemson Univ

WADE H DYSON JR
Genencor Int'l Inc

GILBERT B ELLERBE†
LanXess

HELEN H EPPS
Univ of Georgia

LEONARD T FARIAS
Cotton Inc

FRANK A FUSS†
MeadWestvaco Corp

BARBARA M
GATEWOOD†
Kansas State Univ

CHARLES E GAVIN III
MFG Chem Inc

GREGORY D GEORGE
Innovative Chem
Technologies Inc

JAYAKUMAR
GOPALAKRISHNAN†
Global Resources
Management Grp

HAROLD K GREESON
JR†
Cotton Inc

MARGUERITA C HINDLE
TCE Consulting Service

DAVID HINKS
NC State Univ

JUDY B HOLDEN
Cotton Inc

NELSON E HOUSER†
M Dohmen USA Inc

KANTI A JASANI†
Guilford Mills Inc

BETH G JOINER
NAMSA

NORMA M KEYES†
Cotton Inc

BILL KIMBRELL†
Milliken & Co

SANDRA KOLBY†
Bentley Prince Street

ROLF G KUEHNI†

ANN C LAIDLAW
GrettagMacbeth LLC

JOHN C LARK†

ROBERT K LATTIE†
SDL Atlas LLC

TIMOTHY A LITTLE
Ciba Specialty Chem Corp

CHARLES D LIVENGOOD

JODI B LYNCH†
Hosiery Tech Center

RICHARD A
MALACHOWSKI†
Cranston Print Works Co

WILLIAM R MARTIN JR

ANGELA B
MASSENGILL†
Cotton Inc

ROBERT FREDERICK
MILLER JR†
Hickory Yarns

JAMIE E MOAK†
Procter & Gamble

LUTHER M MYERS
Textile Innovators Corp

BRAHAM NORWICK

EDGAR J PAGE

D C PATEL

NANCY E PEBENITO†
Nike

ROBERT E PELLETIER†
Duro Ind Inc

WARREN S PERKINS

THOMAS H PERRY JR†
Dow Chem Co

DAVID L RAMEY†
Microban Products Co

LEANDER B RICARD

JANETT RICE
Intertek Testing Serv

DONALD W ROBINSON

JAMES E RODGERS III†
SRRS ARS USDA

JAMES W RUCKER

ADRIENNE M RYBAK†
Int'l Fabricare Inst

LUISA D SANTOS
US Army Natick Soldier
Center

FERNAND SCHLAEPPI

CHRIS W SCHOOUTEN†

THOMAS P SCOTT JR
Cotton Inc

GARRETT A SCREWS JR
Novozymes NA Inc

EDGAR L SELF II
Unifi Inc

JAYANT K SHAH††

RAYMOND E SILVA JR
Z-TEX

RICHARD SLOMKO†
Atlas Weathering Svs Grp

GENEVIEVE M SMITH

HARRY S SPARROW†
Rohm & Haas Co

CHARLES W STEWART†
Tumbling Colors Inc

L KENT SUDDETH
Independent Textile
Testing Service Inc

CHARLES D SWEENEY
CDS Laboratories Inc

JERRY G TEW

WAYNE C TINCHER
Georgia Inst of Tech

BROOKS G TIPPETT
Pantone Inc

REMBERT J TRUESDALE
III†
Southern Mills Inc

R CARROLL TURNER
Carpet and Rug Inst

ADAM R VARLEY†
Vartest Int'l Inc

JAYSON C VASSALLO†
PhiChem

NODIE M WASHINGTON†
Procter & Gamble

R LEE WAYLAND JR

MANFRED WENTZ
Textile Care Int'l (TCI) Ltd

HEIDI WOODACRE†
Talbots

LAVAL YAU†
Thomson Research Assoc

C5 Appropriations Committee

<i>Chair</i> ROLAND L CONNELLY SR GregtagMacbeth LLC	<i>Secretary</i> JOHN Y DANIELS AATCC	
MARTIN J BIDE† Univ of Rhode Island	CHARLES E GAVIN III† MFG Chem Inc	ROBERT K LATTIE† SDL Atlas LLC
JOHN A DARSEY JR† Color Solutions Int'l	NELSON E HOUSER† M Dohmen USA Inc	WARREN S PERKINS Retired

C6 Membership Committee

<i>Chair</i> ROBERT FREDERICK MILLER JR Hickory Yarns	<i>Secretary</i> BIRGIT W PATTY AATCC	
ROY J BAMFORD† Aurora Textile Finishing Co	JOHN A DARSEY JR† Color Solutions Int'l	ROBERT K LATTIE† SDL Atlas LLC
MARTIN J BIDE† Univ of Rhode Island	JAYAKUMAR GOPALAKRISHNAN† Global Resources Management Grp	RICHARD A MALACHOWSKI† Cranston Print Works Co
STEPHEN B BROOKS† National Textiles	KANTI A JASANI† Guilford Mills Inc	REMBERT J TRUESDALE III† Southern Mills Inc
FRED L COOK† Georgia Inst of Tech	KERRY MAGUIRE KING Textile Clothing Tech Corp	HEIDI WOODACRE† Talbots
JOHN Y DANIELS† AATCC		

The following section representatives also serve as members of the Membership Committee:

Delaware Valley BRUCE G PUDLOCK	Hudson-Mohawk LEANDER B RICARD	North West SUSAN L MATTER Nordstrom
Gulf Coast GRACE W NAMWAMBA Southern Univ	Metropolitan MICHAEL J ZAVAGLIA Amitech	Palmetto SAMUEL LUTHER BALLARD Omnova Solutions Inc

C7 Publications Committee

<i>Chair</i> KEITH R BECK NC State Univ	<i>Secretary</i> SHERRI A SATTERWHITE AATCC	
J RICHARD ASPLAND Clemson Univ	JOHN Y DANIELS† AATCC	ANN C LAIDLAW GretagMacbeth LLC
PRISCILLA R BAILEY- PADILLA Russell Athletic	HAROLD S FREEMAN† NC State Univ	ROBERT K LATTIE† SDL Atlas LLC
BENNETT R BAIRD Material Science & Innovation LLC	CHARLES E GAVIN III† MFG Chem Inc	DAVID M LEWIS Univ of Leeds
ROY J BAMFORD† Aurora Textile Finishing Co	JAYAKUMAR GOPALAKRISHNAN† Global Resources Management Grp	ROBERT FREDERICK MILLER JR† Hickory Yarns
MARTIN J BIDE† Univ of Rhode Island	KATHRYN L HATCH Univ of Arizona	MARY A MOORE Florida State Univ
PHILIP J BROWN Clemson Univ	NELSON E HOUSER M Dohmen USA Inc	ILDO E PENZA HARRIE P SCHOOTS Rohm and Haas Co
JEANETTE M CARDAMONE USDA ARS ERRC	KANTI A JASANI† Guilford Mills Inc	MICHAEL G SIMMONS
HYUNG-MIN CHOI Soongsil Univ	AARON F JOHNSON Target Corporation	REMBERT J TRUESDALE III† Southern Mills Inc
THOMAS C COX Amitech	KERRY MAGUIRE KING Textile Clothing Tech Corp	HEIDI WOODACRE† Talbots

Subcommittees of the Publications Committee

C7-S1 Colour Index Editorial Committee

<i>Chair</i> HAROLD S FREEMAN NC State Univ	<i>Secretary</i> AMY G HAMMONDS AATCC	
J RICHARD ASPLAND Clemson Univ	MARTIN B BOCHNER	J LAWRENCE ROBINSON† CPMA
KEITH R BECK† NC State Univ	HAROLD F FITZPATRICK† Fitzpatrick & Waterman	JERRY G TEW MAX A WEAVER

C9 Constitution & Bylaws Committee

<i>Chair</i> FRED L COOK Georgia Inst of Tech	<i>Secretary</i> JOHN Y DANIELS AATCC	
MARTIN J BIDE† Univ of Rhode Island	CHARLES E GAVIN III MFG Chem Inc	ROBERT K LATTIE† SDL Atlas LLC
JOHN A DARSEY JR Color Solutions Int'l		

C11 Committee on Conferences

<i>Chair</i> BRIAN C FRANCOIS Cognis Corp	<i>Secretary</i> PEGGY J PICKETT AATCC	
WILLIAM E BAIRD JR Milliken & Co	PAUL J COTE† Cote Color Corp	ROBERT K LATTIE† SDL Atlas LLC
ROY J BAMFORD† Aurora Textile Finishing Co	JOHN Y DANIELS† AATCC	RICHARD A MALACHOWSKI† Cranston Print Works Co
MARTIN J BIDE† Univ of Rhode Island	JOHN A DARSEY JR† Color Solutions Int'l	ROBERT FREDERICK MILLER JR† Hickory Yarns
STEPHEN B BROOKS† National Textiles	CHARLES E GAVIN III† MFG Chem Inc	JILL M SIMMONS Lectra USA Inc
CHARLES R BUMPUS† Dyutex Inc	JAYAKUMAR GOPALAKRISHNAN† Global Resources Management Grp	GLEN T TOWNLEY† Ciba SC
ROLAND L CONNELLY SR GretagMacbeth LLC	WILTON R GOYNES† SRRC ARS USDA	REMBERT J TRUESDALE III† Southern Mills Inc
FRED L COOK† Georgia Inst of Tech	KANTI A JASANI† Guilford Mills Inc	HEIDI WOODACRE† Talbots

C15 Textile Education Committee

Note: Faculty Advisors of AATCC Student Chapters are non-voting ex-officio members of the Textile Education Committee.

<i>Chair</i> IAN R HARDIN Univ of Georgia	<i>Secretary</i> PEGGY J PICKETT AATCC	
J RICHARD ASPLAND Clemson Univ	KANTI A JASANI Guilford Mills Inc	ANN C LAIDLAW GretagMacbeth LLC
MARTIN J BIDE† Univ of Rhode Island	KERRY MAGUIRE KING Textile Clothing Tech Corp	ROBERT K LATTIE† SDL Atlas LLC
FRED L COOK Georgia Inst of Tech	KAREN E KYLLO Intertek	RENZO SHAMEY NC State Univ

C17 Education Advisory Board

<i>Chair</i> NELSON E HOUSER M Dohmen USA Inc	<i>Secretary</i> PEGGY J PICKETT AATCC	
MARTIN J BIDE† Univ of Rhode Island	JOHN A DARSEY JR† Color Solutions Int'l	EUGENE MADDOX Mohawk Ind
MARY N BRANNON STEPHEN B BROOKS† National Textiles	WILLIAM F DIXON JR LEONARD T FARIAS Cotton Inc	RICHARD A MALACHOWSKI† Cranston Print Works Co
ROLAND L CONNELLY SR GretagMacbeth LLC	KANTI A JASANI Guilford Mills Inc	RICHARD S SIMONSON† Burlington Ind
FRED L COOK† Georgia Inst of Tech	MELANIE P JONES Precision Fabrics Grp Inc	ANTHONY J WEBBER Adaptive Control
JOHN Y DANIELS† AATCC	ROBERT K LATTIE† SDL Atlas LLC	

CS61 Harold C Chapin Award Committee

<i>Chair</i> JIMM C BARBERY Apollo Chem Co	<i>Secretary</i> JOHN Y DANIELS AATCC	
J PRESTON ALDRIDGE JR FTA Inc	ELIZABETH P EASTER Univ of Kentucky	ROBERT K LATTIE† SDL Atlas LLC
ADI B CHEHNA Textile Tech Services	DAVID R FENSTERMAKER Ciba Specialty Chem Corp	

* Nonvoting
† Ex Officio
‡ Nonmember AATCC

CS65 Olney Medal Award Committee

Chair
PETER J HAUSER
NC State Univ

Secretary
JOHN Y DANIELS
AATCC

ROY J BAMFORD
Aurora Textile Finishing
Co

BILLY R GARDNER
Boehme Filatex Inc

ROBERT K LATTIE†
SDL Atlas LLC

FRED L COLLINS
M Dohmen USA

CS70 Henry E Millson Award for Invention Committee

Chair
FRED L COOK
Georgia Inst of Tech

Secretary
JOHN Y DANIELS
AATCC

J RICHARD ASPLAND
Clemson Univ

ROBERT K LATTIE†
SDL Atlas LLC

CHARLES Q YANG
Univ of Georgia

FRANK A FUSS
MeadWestvaco Corp

BROOKS G TIPPETT
Pantone Inc

Concept 2 Consumer

Mission: To stimulate and expand knowledge of AATCC to the retail, merchandising, and design community in order to increase membership and participation in AATCC and C2C activities.

Chair
JOHN A DARSEY JR
Color Solutions Int'l

Secretary
ANN C LAIDLAW
GretagMacbeth LLC

At Large Member
KAREN E KYLLO
Intertek

ROLAND L CONNELLY SR†
GretagMacBeth LLC

ROBERT K LATTIE†
SDL Atlas LLC

Materials

Mission: To stimulate and expand the knowledge base of developing new and novel materials related to the fiber/fiber products industries via innovative modifications of existing structures and/or creation of compositions of matter. The new materials may be chemical in nature (preparation aids, colorants, finishes, polymers, etc.), or physical structures (fibers, wovens, carpets, nonwovens, etc.), concentrating on the science and engineering used to create them along with any technologies, equipment, systems and processes developed for their commercial production, and including their tested physical/mechanical properties.

Chair
FRED L COOK
Georgia Inst of Tech
Inc

Secretary
To Be Designated

At Large Member
MARCIA L QUINLAN
Albany Int'l Techniweave

Interest Groups

Interest groups shall be based on a commonality of interest in a particular subject matter and not on geographic designation. Individual AATCC members can join more than one interest group and are considered to be members of that interest group.

Chemical Applications

Mission: To stimulate and expand the knowledge base of applying chemicals (preparation aids, colorants, finishes, polymers, etc.) to substrates; concentrating on the technologies, equipment, systems and processes used, and including the tested physical/mechanical properties of treated materials.

Chair
STEPHEN B BROOKS
National Textiles

Secretary
REMBERT J TRUESDALE
III
Southern Mills Inc

At Large Member
RANDALL A COX
Boehme Filatex Inc

Past Presidents (Living)

PAUL O ANDERSON
(1979-80)

CHARLES E GAVIN III
(1999-00)
MFG Chem Inc

HUGH PATRICK JR
(1985-86)
H&M Marine Products

NICK J CHRISTIE
(1993-94)
Global Textile Chem Tech
Consultants

MARGUERITA C HINDLE
(1987-88)
TCE Consulting Serv

WARREN S PERKINS
(1991-92)

ROLAND L CONNELLY SR
(2003-04)
GretagMacBeth LLC

NELSON E HOUSER
(1997-98)
M Dohmen USA Inc

DONALD W ROBINSON
(1968)

JOHN A DARSEY JR
(2001-02)
Color Solutions Int'l

FREDERICK K JONES
(1995-96)
Northeast Dye

E JAMES STAVRAKAS
(1983-84)

GEORGE S WHAM
(1975-76)

* Nonvoting
† Ex Officio
‡ Nonmember AATCC

Research Committees

Research committees are appointed by, and work under, the Technical Committee on Research. To locate committees by subject see the index below. The committees are arranged in numerical order with the RA or Active Research Committees

followed by the RR or Reference Committees. Non-voting members are marked *, nonmembers of AATCC †. The date shown following a chair's name indicates the beginning year of his term as chair.

Alphabetical Index to Research Committees

Subject	Committee	Page	Subject	Committee	Page
Abrasion Resistance.....	RA29	443	Fibrous Test Materials.....	RA59	446
Ageing of Sulfur-Dyed Textiles.....	RR9	452	Finish Analysis.....	RR45	452
Antimicrobial Activity.....	RA31	443	Flammability Technology.....	RA109	451
Appearance Retention.....	RA61	447	Flock Technology.....	RA76	448
Applied Dyeing and Characterization of Dyes.....	RA87	449	Flock Testing.....	RR81	452
Assessment of Barré.....	RR97	452	Floor Covering.....	RA57	446
Assessment of Dye Strength and Shade.....	RR98	452	Garment Wet Processing Technology.....	RA104	450
Chelating Agent Evaluation.....	RA90	449	Hand Evaluation.....	RA89	449
Chlorine, Retained, Damage by.....	RR35	452	Home Laundering Technology.....	RA88	449
Coated, Bonded and Laminated Fabrics.....	RA79	448	Hosiery.....	RA71	448
Color Measurement.....	RA36	444	Insect Resistance.....	RA49	445
Colorfastness to:			Interaction of Dyes and Finishes.....	RR92	452
Acids and Alkalis.....	RR1	452	Mercerization.....	RA66	447
Atmospheric Contaminants.....	RA33	443	Odor Determination.....	RR68	452
Crocking.....	RA38	444	Preparation.....	RA34	444
Heat.....	RR54	452	Printing Technology.....	RA80	449
Light.....	RA50	445	Professional Textile Care.....	RA43	445
Perspiration.....	RR52	452	Safety, Health and Environmental Technology.....	RA100	450
Pleating.....	RR53	452	Spectroscopic Technologies.....	RA103	450
Washing.....	RA60	446	Stain Resistance.....	RA56	446
Water.....	RA23	443	Static Electricity.....	RA32	443
Correlation of Laboratory Tests with End-Use Performance.....	RA75	448	Statistics Advisory.....	RA102	450
Damage By Retained Chlorine.....	RR35	452	Supercritical Fluid.....	RA105	451
Dimensional Changes.....	RA42	445	Technical Manual Editorial Review.....	RA99	450
Elastic Fabrics Technology.....	RA107	451	UV Protective Textiles.....	RA106	451
Enzyme Activity.....	RA41	444	Warp Size Technology.....	RA73	448
Fiber Analysis.....	RA24	443	Water Resistance, Absorbency and Wetting Agent Evaluation.....	RA63	447
			Weather Resistance.....	RA64	447
			Yarn Dyeing Technology.....	RA70	447

RA23 Colorfastness to Water Test Methods

Scope: To develop test methods for measuring the resistance of colors in all kinds of textiles to change, transfer or spotting by any type of water such as fresh water, sea water and chlorinated swimming pool water. Test Methods 104, 106, 107, 162.

Chair

To Be Designated

PATRICK J BRENNAN*
Q-Panel Lab Products
HELEN H EPPS*
Univ of Georgia
GREGORY D GEORGE*
Innovative Chem Tech Inc
CAROL GRAHAM*
James H Heal & Co Ltd
JAMES DENNIS HART*†
Shaw Ind
JAMES V HUBER*†
YESENIA C JUAREZ*
Eldorado Stone LLC

Secretary

To Be Designated

LEON J KELLER JR
SANDRA KOLBY*
Bentley Prince Street
MARTIN KORNSHAUSER
ROBERT K LATTIE*
SDL Atlas LLC
TIMOTHY A LITTLE*
Ciba Specialty Chem Corp
KLAUS J MACKERT
SUSAN L MATTER*
Nordstrom
JOHN L MORRIS*†
Technicare Servs Ltd

ALBERT B OUIMET
Warnaco Technical Ctr
GEORGE T ROBERTS
NORMAN I SCHNEIDER*
Int'l Executive Service Corps
RICHARD S SIMONSON*
Burlington Ind
ERNEST R TURNER*
Mohawk Ind Inc
R CARROLL TURNER*
Carpet and Rug Inst
JERRY T WRIGHT JR*
Shaw Ind

RA24 Fiber Analysis Test Methods

Scope: To develop test methods for the qualitative identification and the quantitative determination of fiber mixtures. Test Methods 20, 20A.

Acting Chair

ADAM R VARLEY
Vartest Int'l Inc

Secretary

KENNETH D LANGLEY
Univ of Mass Dartmouth

NIKHIL AGRAWAL
Unilever HPC USA
TODD A ALLAIN*†
L W Packard & Co
JOHN E BARNETTE II*†
Barnette Consulting
PRIMO RICCARDO
BRACHI
Perito Tessili
ALLISON LONDON
BROWN*†
American Garment
Finishers Corp
GULTEKIN CELIKIZ*
THOMAS CHAN
Bureaus Veritas-CPS Inc
SIMON CHEE*†
Fastech Int'l
ADI B CHEHNA
Textile Tech Servs
HSIOU-LIEN CHEN
Oregon State Univ
BILLY LAU CHI PIU*
Specialized Tech Resources
(HK) Ltd
QING S DUNCAN*
Swiss Tex California
CAROL A FITZGERALD†
Liz Claiborne Accessories
BARBARA M GATEWOOD
Kansas State Univ
JOHN H HALL JR*†
Shaw Ind
JACK T HERR*†
Bureau Veritas
JUDY B HOLDEN*
Cotton Inc

MAX M HOUCK
West Virginia Univ
YOUSSEF H ISMAEIL
Pantone Inc
YESENIA C JUAREZ*
Eldorado Stone LLC
CLYDE S KELLER
Reeves Brothers Inc
MICHELLE E KELLEY*
DeRoyal Textiles
SANDEEP KHATUA*
Bureau Veritas CPS Inc
SANDRA KOLBY*
Bentley Prince Street
AMY S Y LEE*
Intertek Labtest
TAK MING MAN
Bodycote Ortech Corp
SUSAN L MATTER*
Nordstrom
ARTHUR G MERIMS
IOAN I NEGULESCU
Louisiana State Univ
ALBERT B OUIMET
Warnaco Technical Ctr
RONALD J PACHECO
Specialized Technology
Resources
EDGAR J PAGE
LINZI N PRICE*
Consumer Testing
Laboratories
MIR A QUDDUS*
Whirlpool
RONA L REID
Dow Chem Co

HEATHER E
ROBERTSON
Govmark Organization Inc
JAMES E RODGERS III
SRRC ARS USDA
CYNTHIA L ROONEY
Coach Leatherware
LAURA T SCOTT*
Walmart Stores Inc
SIDDHARTHA
SENGUPTA*†
Univ of Calcutta
JUTTA SICH*†
PAT A SLAVEN
Consumers Union
GENEVIEVE M SMITH*
KARL SPILHAUS
Cashmere & Camel Hair
Mfg Inst
ERNEST R TURNER*
Mohawk Ind
FRANZ JOSEF
WORTMANN*†
DWI-German Wool
Research Inst
BUGAO XU
Univ of Texas Austin
CH ZAH*
Interface Inc
ZHI ZHANG
Inner Mongolia Erdos
Cashmere Grp
CHARLES ZHU
SDL Atlas Shanghai
REIYAO ZHU*†
Texas Tech Univ
YONG ZHU*
Procter & Gamble

RA29 Abrasion Resistance Test Methods

Scope: To develop test methods for measuring the resistance of textiles to abrasion. Test Methods 93, 119, 120.

Chair

To Be Designated

NIKHIL AGRAWAL
Unilever HPC USA
PATRICIA A ANNIS
Univ of Georgia
ADI B CHEHNA*
Textile Tech Servs

Secretary

To Be Designated

ROBERT B CLEAVER*
SANJEEV GANDHI
Intertek
JUDY B HOLDEN
Cotton Inc
ROBERT K LATTIE*
SDL Atlas LLC

ADETOMIWA ADETUNJI
OPAFOLA†
Aptitude Investment Ltd
JAMES W ROTHROCK*†
LAURA T SCOTT*
Walmart Stores Inc
TIM ZIEGENFUS*
Advanced Testing
Instruments Corp

* Nonvoting
† Nonmember AATCC

RA31 Antimicrobial Activity Test Methods

Scope: To develop test methods for detection and measurement of antimicrobial activity of treated textiles. Test Methods 24, 28, 30, 100, 147, 174.

Chair

DAVID L RAMEY '05
Microban Products Co

Secretary

DAVID P KLEIN
Thomson Research Assoc

ROBERTA N ALTMAN*
Clariant Corp
PATRICIA A ANNIS
Univ of Georgia
GEORGE L
BAUGHMAN*†
Univ of Georgia
MICHAEL E BELL
Mohawk Ind
JULIE B BRUMBELOW*†
Shaw Ind
ROBERT V CASCIANI
Clariant Corp
JOHN M CEBALLOS*†
Morton Int'l
HSIOU-LIEN CHEN
Oregon State Univ
PETER G CHRISTIAN*
Bloomsburg Mills
PETER J
DYLINGOWSKI*†
Rohm & Haas
ELIZABETH A EGGERT
Procter & Gamble
ROBERT J
FENSTERHEIM*†
SBLC/EPC/APERC
GREGORY D GEORGE
Innovative Chem Tech Inc

MARTIN E GURIAN
DesignTex Grp
WILLIAM D HANRAHAN*
Microban Products Co
BETH G JOINER
NAMSA
YESENIA C JUAREZ*
Eldorado Stone LLC
BRANDON S KERSEY
Mannington Commercial
Carpet
STEWART E KLEIN
Sanitized Inc
SANDRA KOLBY
Bentley Prince Street
BRADLEY G MARTIN
Burlington Ind
CAROLINA MATEUS*
Milliken & Co
ROBERT E MAY†
EDWARD J MCNAMARA
Emco Servs Inc
IOAN I NEGULESCU
Louisiana State Univ
THOMAS H PERRY JR
Dow Chem Co
DANIEL L PRICE
InterFace Research Corp

MIR A QUDDUS*
Whirlpool
WILLIAM A REARICK
Cotton Inc
GLENN R RUNCIMAN*
Thomson Research Assoc
EDITH F SANFORD
JCPenney Co
RICHARD S SIMONSON*
Burlington Ind
ODALIS A TEJADA
Tommy Hilfiger USA
ERNEST R TURNER*
Mohawk Ind
R CARROLL TURNER
Carpet and Rug Inst
ALEX L VAINSHELBOIM
Aveda Corp
W CURTIS WHITE
Aegis Environmental
Management
KENNETH M WIENCEK
Milliken & Co
JERRY T WRIGHT JR*
Shaw Ind
LAVAL YAU*
Thomson Research Assoc

RA32 Static Electricity Test Methods

Scope: To develop test methods for predicting the electrostatic behavior of static electrical charges. Test Methods 76, 84, 115, 134.

Acting Chair

STEPHEN L FOWLER
Fowler Assoc Inc

Secretary

To Be Designated

JESSICA ANN
Milliken & Co
EDWARD B BALDWIN JR*
MICHAEL E BELL
Mohawk Ind
TONI A BROWN
Interface Flooring System
JULIE B BRUMBELOW*†
Shaw Ind
ALAN F BUTTENHOFF
Shaw Ind
JOHN H HALL JR*†
Shaw Ind
SALLY HASSELBRACK
STEVE C JAMES†
DARA A JILLA*†
Embassy Carpets
YESENIA C JUAREZ*
Eldorado Stone LLC
BRANDON S KERSEY*
Mannington Commercial
Carpet

WILLIAM G KLEIN*†
K&S Laboratories Inc
SANDRA KOLBY
Bentley Prince Street
TAK MING MAN*
Bodycote Ortech Corp
ELIZABETH G
MCFARLAND
INVISTA
HAMIR D MERCHANT*†
Takata Inc
CAREY R MITCHELL*
Shaw Ind
THOMAS H PERRY JR
Dow Chem Co
GREG PHILLIPS
Professional Testing Lab
Inc
DAVID L RAMEY*
Microban Products Co
JAMES E RODGERS III*
SRRC ARS USDA

RICHARD S SIMONSON*
Burlington Ind
ROGER C STEINHAUER*
L KENT SUDDETH
Independent Textile
Testing Service Inc
ERNEST R TURNER
Mohawk Ind
R CARROLL TURNER
Carpet and Rug Inst
SAMUEL C O UGBOLUE
Univ of Mass
KRISTINA K UNDERLY
Whirlpool Corp
CYNTHIA C WOODSON*†
Interface Flooring Systems
Inc
JERRY T WRIGHT JR*
Shaw Ind
HOWARD M ZINS*†
Angelica Image Apparel

RA33 Colorfastness to Atmospheric Contaminants Test Methods

Scope: To study the factors in atmospheric exposure, other than photochemical influences, which cause color changes; to develop test methods for measuring color changes that will reliably correlate with end use. Contaminants under study include oxides of nitrogen, ozone, sulfur dioxide and products of hydrocarbon combustion. Test Methods 23, 109, 129, 164.

Acting Chair

LUTHER M MYERS
Textile Innovators Corp

Secretary

To Be Designated

MICHAEL E BELL*
Mohawk Ind
BARBARA M
GATEWOOD*
Kansas State Univ

GREGORY D GEORGE
Innovative Chem Tech Inc
MICHEL A HERLANT
DAVID H HOLLAND

KANTI A JASANI*
Guilford Mills Inc
BRANDON S KERSEY
Mannington Commercial
Carpet

THOMAS A KLAAS Testfabrics Inc	CAREY R MITCHELL* Shaw Ind	MAJID SARMADI Univ of Wisconsin-Madison	SANDRA KOLBY* Bentley Prince Street	BERNARD P OLSZOWY FARHAN M A PATEL Limited Express	GREGORY J STEHN* GretagMacBeth LLC
SANDRA KOLBY* Bentley Prince Street	JOHN L MORRIS† Technicare Servs Ltd	ERNEST R TURNER* Mohawk Ind	ANN C LAIDLAW GretagMacbeth LLC	DANIEL L RANDALL* Datacolor	THOMAS E STUTTS* Datacolor
TIMOTHY A LITTLE* Ciba Specialty Chem Corp	SUNDAR MOHAN RAO Invista	JAKIE T WELCH Georgia Narrow Fabrics Corp	JOHN S LOCKE E I DuPont	MICHAEL F REAVES Blackman Uhler Chem Co	FUJIO SUGA* Suga Testing Instruments Co Ltd
KLAUS J MACKERT* EUGENE MADDOX Mohawk Ind	JANETT RICE* Intertek	JERRY T WRIGHT JR* Shaw Ind	DILIP B LOKRE* Gap Inc	D SCOTT REININGER Global Color Systems	NAGAICHI SUGA Suga Testing Instruments Co Ltd

RA34 Preparation Test Methods

Scope: To develop test methods for (1) measuring the effect of preparation (defined as all wet steps prior to dyeing, printing or finishing of white textile fibers, yarns or fabrics) upon the chemical, physical and colorfastness properties of these textiles; (2) evaluating the effectiveness of preparation chemicals; and (3) controlling preparation processes including methods for obtaining information about materials on the textiles to be prepared. Test Methods 78, 81, 82, 97, 98, 101, 102, 144.

<i>Chair</i> HAROLD K GREESON JR '04 Cotton Inc	<i>Secretary</i> PETER J HAUSER NC State Univ				
B SCOTT BAILEY† Ciba Specialty Chems Corp	BRIAN C FRANCOIS* Cognis Corp	PHILIP S PATRICK Excel Products	VINCENT A MONFALCONE III Levolor-Kirsch Window Fashions	LAURA T SCOTT Walmart Stores Inc	NORM URESS Advanced Color Tech Inc
RICHARD A BARNHARDT Apollo Chem Corp	LORRAINE A GALICA† American Fiber & Finishing Inc	KEVIN S PEELE†† Color-Tex Finishing	MARY A MOORE Florida State Univ	RENZO SHAMEY* NC State Univ	WILLIAM S VOGEL Lantal Textiles Inc
BRUCE J BISHOP* Bruce Chem Co	JOHN M GRIMES High Point Text Auxiliaries LLC	GUO-WEI QIN† Tex-Tenn Corp	LEON S MOSER* NC State Univ	ALLEN H SIMPSON Raitech Inc	JAKIE T WELCH Georgia Narrow Fabrics Corp
RICHARD O BROWN BGB Stockhausen	JOHN HARBISON Scholler Inc	JAMES W RUCKER SIDDARTHA SARIN†† Buster Brown Apparel	NIGEL E NEELY Springs Ind	CEVIN BRENT SMITH MARK D SPEIGHT Breux Mfg Co Inc	WANDA DENISE WILKS Textile Innovators Corp
NICK J CHRISTIE* Global Textile Chem Tech Consultants	PAMELA J JACO Springs Ind	RAYMOND E SILVA JR Z-TEX	WILLIAM G NEWSOME JR†† Springs Ind	ARTHUR W SPRINGSTEEN Avian Tech	ROBERT F WILLIS* GretagMacBeth LLC
ROBERT B CLEAVER* GARY S DAGENHART Clariant Corp	AARON F JOHNSON* Target Corp	JOSEPH M STROTHER Pillowtex Corp			
MYLUE T DO MARVEL Sale	ROBERT J JONES JR Cognis Corp	RAJESH S TARI†† Caretex Exports			
QING S DUNCAN* Swiss Tex California	GARY C LICKFIELD Clemson Univ	DANIEL S THOMPSON† Sunbelt Corp			
WADE H DYSON JR Genencor Int'l Inc	LEWIS F MCINTYRE SR* Yorkshire Americas Inc	EDWIN T TURNER* Cotton Inc			
EDWARD J ELLIOTT ANDREW V FARLEY*	GARY N MOCK* NC State Univ	WANDA DENISE WILKS Textile Innovators Corp			
	DHARNIDHAR V PARIKH USDA SRRC	WILLIAM P WILLIS Willis Consultants			

RA36 Color Measurement Test Methods

Scope: To develop test methods relating to color science, to advise other AATCC committees involved with special problems on color, and to provide liaison between AATCC and other groups directly concerned with problems in color science. Test Methods 110, 173, 182, EP1, EP2, EP3, EP4, EP6, EP7, EP8, EP9.

<i>Chair</i> ROLF G KUEHNI '03	<i>Secretary</i> DAVID HINKS NC State Univ				
AYSE UFUK AGAR* Hewlett Packard Co	GULTEKIN CELIKIZ A K ROY CHOUDHURY*† College of Textile Tech	FRANK A FUSS MeadWestvaco Corp	KAREN F GASKINS* Datacolor	KAI WAI VINCENT LEUNG Tribal Sportswear Inc	ROGER C STEINHAUER* MARGARET P THERRELL Springs Ind
J RICHARD ASPLAND Clemson Univ	PETER G CHRISTIAN* Bloomsburg Mills	KAREN F GASKINS* Datacolor	HAROLD C GOOD JR HunterLab	TIMOTHY A LITTLE Ciba Specialty Chem Corp	CHARLES R TROMMER ADAM R VARLEY* Vartest Int'l Inc
PATRICK A AYERS Maidenform	ROLAND L CONNELLY SR* GretagMacBeth	RICHARD W HAROLD* Color and Appearance Consulting LLC	RICHARD W HAROLD* Color and Appearance Consulting LLC	JOHN L MORRIS†† Technicare Servs Ltd	KAREN M MUESER CAROL J NERI* Battelle/NSS
PRISCILLA R BAILEY- PADILLA* Russell Athletic	JOHN A DARSEY JR Color Solutions Int'l	GEORGE C HOOD Ames Textile	KEITH D HOOVER Lands' End	KAREN M MUESER CAROL J NERI* Battelle/NSS	RONALD E WEBBER JERRY T WRIGHT JR* Shaw Ind
MICHAEL E BELL* Mohawk Ind	NORMAN R DEMERS* Konica Minolta	KEITH D HOOVER Lands' End	SHARLA JEAN HOSKIN May Merchandising Co	ANNE PATTERSON†† Simon Paterson Assoc Inc	TIM ZIEGENFUS* Advanced Testing Instruments Corp
RALPH BESNOY MARTIN J BIDE Univ of Rhode Island	JOSEPH DIWAN Sara Lee Branded Apparel	SHARLA JEAN HOSKIN May Merchandising Co	MAX M HOUCK West Virginia Univ		
JAMES A BIGGERSTAFF Haggar Clothing Co	ELIZABETH P EASTER Univ of Kentucky	ABDULHALIK ISKENDER Univ of Uludag	ABDULHALIK ISKENDER Univ of Uludag		
DEBBIE E BLALOCK* Nike	ELIZABETH A EGGERT Procter & Gamble	KANTI A JASANI* Guilford Mills Inc	AARON F JOHNSON* Target Corp		
MARY N BRANNON KENNETH R BUTTS Datacolor	HOWELL M EPPERLY Russell Corp	YESSSENIA C JUAREZ Eldorado Stone LLC	YESSSENIA C JUAREZ Eldorado Stone LLC		
ELLEN C CARTER Color Research and Application	HELEN H EPPS* Univ of Georgia	FRANK L KOGER X-Rite Inc	FRANK L KOGER X-Rite Inc		
	DONNA D FABER* JUAN A FARAJ Gildan Activewear				

* Nonvoting
† Nonmember AATCC

RA38 Colorfastness to Crocking Test Methods

Scope: To develop test methods for measuring resistance of colors in textiles to transfer by rubbing; to modify and improve the crockmeter to enlarge its adaptability. Test Methods 8, 116.

<i>Chair</i> RICHARD SLOMKO '03 Atlas Weathering Svs Grp	<i>Secretary</i> CAROL GRAHAM James H Heal & Co Ltd				
F POWELL ANDREWS III Dillard's Store	YESSSENIA C JUAREZ* Eldorado Stone LLC	CHARLES D QUIRK Rohm & Haas Co	MICHAEL E BELL* Mohawk Ind	V KENNETH KISER III Apparel Testing Servs	JANETT RICE* Intertek
JANACE E BUBONIA- CLARKE Texas Christian Univ	SUSAN A KURIOTHOWSKI US Army Natick Soldier Ctr	HEATHER E ROBERTSON* Govmark Organization Inc	ANDREA C EKLUND Nordstrom	AMY S Y LEE Intertek	HARRIE P SCHOOTS* Rohm and Haas Co
JOY R FERRIS* PremiumWear	KAI WAI VINCENT LEUNG Tribal Sportswear Inc	JAMES A SHEETS JR* JCPenney Co	JOY R FERRIS* PremiumWear	AMY S Y LEE Intertek	JAMES A SHEETS JR* JCPenney Co
KAREN F GASKINS Datacolor	TIMOTHY A LITTLE Ciba Specialty Chem Corp	ROGER C STEINHAUER* MARGARET P THERRELL Springs Ind	JAMES DENNIS HART†† Shaw Ind	JOHN L MORRIS†† Technicare Servs Ltd	CHARLES R TROMMER ADAM R VARLEY* Vartest Int'l Inc
GREGORY D GEORGE Innovative Chem Tech Inc	JOHN L MORRIS†† Technicare Servs Ltd	RONALD E WEBBER JERRY T WRIGHT JR* Shaw Ind	LISA B HEPFINGER†† US Army Natick RD&E Ctr	KAREN M MUESER CAROL J NERI* Battelle/NSS	TIM ZIEGENFUS* Advanced Testing Instruments Corp
JULIE A HILL† Chemtext Inc	NANCY E HOBBS†† Town & Country Living		JULIE A HILL† Chemtext Inc	ANNE PATTERSON†† Simon Paterson Assoc Inc	
RAJINI JANARDHAN* Bureau Veritas CPS					

RA41 Enzyme Activity Test Methods

Scope: To develop test methods for measuring the activity of enzymes used in the textile industry, and for evaluating their effectiveness under these conditions. Test Method 103, 191.

<i>Chair</i> CHARLES W STEWART '03 Tumbling Colors Inc	<i>Secretary</i> To Be Designated				
MARY V BARNABAS†† Fabric & Hard Surface Tech	ALLISON LONDON BROWN†† American Garment Finishers Corp	JOHN E BRYANT†† Phoenix Chem Co Inc	EUGENE J BLANCHARD SRRC ARS USDA		NICK J CHRISTIE* Global Textile Chem Tech Consultants

THOMAS C COX Amitech	V KENNETH KISER III Apparel Testing Servs	ARKADY P SINITSYN Moscow State Univ	TAK MING MAN Bodycote Ortech Corp	ADETOMIWA ADETUNJI OPAFOLA† Aptitude Investment Ltd	SIDDHARTHA SENGUPTA† Univ of Calcutta
WADE H DYSON JR* Genencor Int'l Inc	MARLENE MUELLER*† Novozymes NA Inc	KULDEEP SULTAN Alpha Processing Co Ltd	STEPHEN E MINTER Ciba Specialty Chemocals Corp	FARHAN M A PATEL Limited Express	RICHARD S SIMONSON* Burlington Ind
MELISSA ELFERS Unilever HPC	WILLIAM C NEHREN*† Softrol Systems Inc	ROBERT F SUTTHOFF Enzyme Development Corp	GARY N MOCK NC State Univ	JANETT RICE* Intertek	GENEVIEVE M SMITH
JOHN W ENGLESTAD UCO Fabrics Inc	WILLIAM M NEXSON*† Genencor Int'l	JAMES A TRAMMEL	VINCENT A MONFALCONE III Levolor-Kirsch Window Fashions	CHARLES L RIGGS Texas Woman's Univ	KAY M VILLA Kay M Villa Consulting Inc
LEONARD T FARIAS* Cotton Inc	MIR A QUDDUS Whirlpool	R MICHAEL TYNDALL Cotton Inc		JAMES L SCHREINER Adco Inc	ANN E WEAVER† 3M Co
CESAR H GUERRERO* Gap Inc	DENNIS C SCHEER Polo Ralph Lauren	JIPING WANG Procter & Gamble		WILLIAM SEITZ	MANFRED WENTZ Textile Care Int'l (TCI) Ltd
GREGORY K HALL* Kimberly-Clark Corp	GARRETT A SCREWS JR Novozymes NA Inc	KENNETH R WESP Clariant			
PHYLLIS S HOWLEY* SRRC USDA ARS	JAYANT K SHAH†	ROBERT J WILSON Gap Inc			
PAMELA J JACO Springs Ind	DANIEL B SHOOK Dyadic Int'l Inc	YONG ZHU* Procter & Gamble			

RA42 Dimensional Changes Test Methods

Scope: To develop test methods for measuring dimensional changes in fabrics or textile articles when subjected to atmospheric change or to home and commercial laundering. Test Methods 96, 99, 135, 150, 179, 187.

<i>Chair</i> ANGELA B MASSENGILL '03 Cotton Inc	<i>Secretary</i> RAJINI JANARDHAN Bureau Veritas CPS				
NIKHIL AGRAWAL Unilever HPC USA	CAROL GRAHAM* James H Heal & Co Ltd	JENNIFER B MORGAN Columbia Sportswear	ROBERTA N ALTMAN* Clariant Corp	BETH G JOINER NAMSA	DANIEL L PRICE InterFace Research Corp
LUIS M ALMEIDA* Universidade Do Minho	J TYLER GROSE Honeywell	JOHN L MORRIS*† Technicare Servs Ltd	LARRY G ARLIAN*† Wright State Univ	ASHUTOSH P KARNIK*† Freudenberg Nonwovens	WILLIAM A REARICK Cotton Inc
F POWELL ANDREWS III Dillard's	D PAGE HENDERSON*† Gerber Childrenswear Inc	GLENN P MORTON*†	MICHAEL E BELL* Mohawk Ind	DAVID P KLEIN* Thomson Research Assoc	GLENN R RUNCIMAN* Thomson Research Assoc
JESSICA ANN* Milliken & Co	ERIC F HEQUET Texas Tech Univ	KAREN M MUESER	ROBERT R BONNER Noveon Inc	STEWART E KLEIN Sanitized Inc	RICHARD S SIMONSON* Burlington Ind
GEORGE E AUCLAIR	NANCY E HOBBS*† Town & Country Living	GUO-WEI QIN† Tex-Tenn Corporation	ROBERT V CASCIANI Clariant Corp	SANDRA KOLBY* Bentley Prince Street	DAVID H THOMSON*† Medical Entomology Centre
DONALD L BAILEY* Cotton Inc	PAMELA J JACO* Springs Ind	MIR A QUDDUS* Whirlpool	SIMON M CAUSER Wool Research Org of NZ	VANNA MAHAKITTIKUN*† Mahidol Univ	ROBIN G TODD Insect Control & Research Inc
DORIS R BENNETT National Textiles	KANTI A JASANI* Guilford Mills Inc	J MARK RAITERI Raitech Inc	MELISSA ELFERS* Unilever HPC-NA	EDWARD J MCNAMARA Emco Servs Inc	AMELIA TOSTI*† Freudenberg Nonwovens
BURTON BLAGMAN	NORMA M KEYES* Cotton Inc	JANETT RICE* Intertek	GREGORY D GEORGE* Innovative Chem Tech Inc	GLEN R NEEDHAM*† Ohio State Univ	EARLE WOLYNES*† Milliken & Co
GEORGE L BRODMANN	SANDEEP KHATUA* Bureau Veritas CPS Inc	HEATHER E ROBERTSON Govmark Organization Inc	WILLIAM D HANRAHAN* Microban Products Co		JERRY T WRIGHT JR* Shaw Ind
JANACE E BUBONIA- CLARKE Texas Christian Univ	FAWZL P KORIAL Handicraft Chem Inc	JAMES W ROTHROCK*†	GARY E HARRIS Unichem Inc		
ADI B CHEHNA Textile Tech Servs	SUSAN A KURIOTHOWSKI US Army Natick Soldier Ctr	FRED B SAVELL III Eastern Color & Chem Corp			
ROBERT B CLEAVER* DAVID P DAPONTE* L L Bean	KAREN E KYLLO Intertek	PETER SCHWARTZ Auburn Univ			
ALVIN D DELMAN	ROBERT LATTIE* SDL Atlas LLC	THOMAS P SCOTT JR			
ANDREA C EKLUND Nordstrom	JODI B LYNCH* Hosiery Technology Ctr	CHERRY M SEARLE Buffalo State College			
HOWELL M EPPERLY Russell Corp	MARGIT MACHACEK*†	MARGARET P THERRELL Springs Ind			
ASH GANDHI* Manhattan Products	CAROLE C MCFEE VF Jeans Wear	A THEVARATNAM*† Marks and Spencer Plc			
JAYAKUMAR GOPALAKRISHNAN Global Resources Management Grp	LEWIS F MCINTYRE SR* Yorkshire Americas Inc	KRISTINA K UNDERLY Whirlpool Corp			
		CHARLES ZHU SDL Atlas Shanghai			

RA43 Professional Textile Care Test Methods

Scope: To develop test methods for measuring the effect of professional textile care (including drycleaning, wet cleaning, finishing, and spot removal) upon the properties of textiles. Test Methods 86, 132, 158.

<i>Chair</i> ADRIENNE M RYBAK '05 Int'l Fabricare Inst	<i>Secretary</i> JOSEPH J NILSEN DSCP DLA				
NOUREDDINE ABIDI Texas Tech Univ	CHI K AU Ocean Lanka Pvt Ltd	ASH GANDHI* Manhattan Products	EDWARD B BALDWIN JR	CAROL GRAHAM* James H Heal & Co Ltd	AMY S Y LEE* Intertek
ARTHUR J ANDREWS Keystone Aniline Corp	JACK E BROADHURST Celanese Acetate	PERRY L GRADY* NC State Univ	MICHAEL E BELL* Mohawk Ind	DALE A HANGEY* RICHARD W HAROLD* Color and Appearance Consulting LLC	TIMOTHY A LITTLE Ciba Specialty Chem Corp
MICHAEL J ARMITAGE Workrite	GEORGE L BRODMANN	SALLY HASSELBRACK	RALPH BESNOY* PAULETTE BRADFORD	BARRY T HAUCK*† US Army Natick RD&E Ctr	EUGENE MADDOX* Mohawk Ind
	PHYLLIS A BURRIS*† Woolmark Co Inc	RAJINI JANARDHAN Bureau Veritas CPS	ALAN F BUTTENHOFF Shaw Ind	LISA B HEPPINGER*† US Army Natick RD&E Ctr	SUSAN L MATTER Nordstrom
	MELISSA ELFERS Unilever HPC-NA	FAWZL P KORIAL Handicraft Chem Inc	MICHAEL V CARTER Spectrum Dyed Yarns Inc	MICHEL A HERLANT* DAVID H HOLLAND	CAREY R MITCHELL* Shaw Ind
			RAYMOND A CASPER*† THERESE R COMMERFORD* US Army	JAMES V HUBER*† ABDULHALIK ISKENDER Univ of Uludag	MARY A MOORE Florida State Univ
			PATRICIA C CREWS Univ of Nebraska	DARA A JILLA*† Embassy Carpets	RONALD A F MOORE*† Honeywell Tech Ctr
			ANDREA C EKLUND* Nordstrom	YESENIA C JUAREZ* Eldorado Stone LLC	JOHN L MORRIS*† Technicare Servs Ltd
			HELEN H EPPS Univ of Georgia	BRANDON S KERSEY* Mannington Commercial Carpet	EDGAR J PAGE KEVIN S PEELE*† Color-Tex Finishing
			HARRY M FRY	NORMA M KEYES* Cotton Inc	KENNETH J PIDGEON† Dr Ken Pridgen & Prof Partners Pty Ltd
			MARY S GAGLIARDI*† Clorox Servs Co	SANDRA KOLBY* Bentley Prince Street	MIR A QUDDUS* Whirlpool
			KAREN F GASKINS Datacolor	CHRISTINE M LADISCH Purdue Univ	JANE H REESE*† Microscal Ltd
			BARBARA M GATEWOOD Kansas State Univ	ROBERT K LATTIE SDL Atlas LLC	JANETT RICE* Intertek
			GREGORY D GEORGE* Innovative Chem Tech Inc		BARRY B RYBNY Yorkshire Americas Inc
			JAYAKUMAR GOPALAKRISHNAN Global Resources Management Grp		

* Nonvoting
† Nonmember AATCC

RA49 Insect Resistance Test Methods

Scope: To be determined.

<i>Chair</i> LAVAL YAU '04 Thomson Research Assoc	<i>Secretary</i> DAVID L RAMEY Microban Products Co				
ROBERTA N ALTMAN* Clariant Corp	BETH G JOINER NAMSA	DANIEL L PRICE InterFace Research Corp			
LARRY G ARLIAN*† Wright State Univ	ASHUTOSH P KARNIK*† Freudenberg Nonwovens	WILLIAM A REARICK Cotton Inc			
MICHAEL E BELL* Mohawk Ind	DAVID P KLEIN* Thomson Research Assoc	GLENN R RUNCIMAN* Thomson Research Assoc			
ROBERT R BONNER Noveon Inc	STEWART E KLEIN Sanitized Inc	RICHARD S SIMONSON* Burlington Ind			
ROBERT V CASCIANI Clariant Corp	SANDRA KOLBY* Bentley Prince Street	DAVID H THOMSON*† Medical Entomology Centre			
SIMON M CAUSER Wool Research Org of NZ	VANNA MAHAKITTIKUN*† Mahidol Univ	ROBIN G TODD Insect Control & Research Inc			
MELISSA ELFERS* Unilever HPC-NA	BRADLEY G MARTIN Burlington Ind	AMELIA TOSTI*† Freudenberg Nonwovens			
GREGORY D GEORGE* Innovative Chem Tech Inc	EDWARD J MCNAMARA Emco Servs Inc	EARLE WOLYNES*† Milliken & Co			
WILLIAM D HANRAHAN* Microban Products Co	GLEN R NEEDHAM*† Ohio State Univ	JERRY T WRIGHT JR* Shaw Ind			
GARY E HARRIS Unichem Inc					

RA50 Colorfastness to Light Test Methods

Scope: To develop and revise, in view of the best current practice, test methods for measuring color changes in textiles under the influence of light, such as carbon-arc, sunlight and daylight; to establish criteria to tell whether influences other than light have caused significant changes in color. Test Methods 16, 125, 126, 139, 177, 181.

<i>Chair</i> NANCY E PEBENITO '04 Nike	<i>Secretary</i> PATRICK J BRENNAN Q-Panel Lab Products				
EDWARD B BALDWIN JR	CAROL GRAHAM* James H Heal & Co Ltd	AMY S Y LEE* Intertek			
MICHAEL E BELL* Mohawk Ind	DALE A HANGEY* RICHARD W HAROLD* Color and Appearance Consulting LLC	TIMOTHY A LITTLE Ciba Specialty Chem Corp			
RALPH BESNOY* PAULETTE BRADFORD	BARRY T HAUCK*† US Army Natick RD&E Ctr	EUGENE MADDOX* Mohawk Ind			
ALAN F BUTTENHOFF Shaw Ind	LISA B HEPPINGER*† US Army Natick RD&E Ctr	SUSAN L MATTER Nordstrom			
MICHAEL V CARTER Spectrum Dyed Yarns Inc	MICHEL A HERLANT* DAVID H HOLLAND	CAREY R MITCHELL* Shaw Ind			
RAYMOND A CASPER*† THERESE R COMMERFORD* US Army	JAMES V HUBER*† ABDULHALIK ISKENDER Univ of Uludag	MARY A MOORE Florida State Univ			
PATRICIA C CREWS Univ of Nebraska	DARA A JILLA*† Embassy Carpets	RONALD A F MOORE*† Honeywell Tech Ctr			
ANDREA C EKLUND* Nordstrom	YESENIA C JUAREZ* Eldorado Stone LLC	JOHN L MORRIS*† Technicare Servs Ltd			
HELEN H EPPS Univ of Georgia	BRANDON S KERSEY* Mannington Commercial Carpet	EDGAR J PAGE KEVIN S PEELE*† Color-Tex Finishing			
HARRY M FRY	NORMA M KEYES* Cotton Inc	KENNETH J PIDGEON† Dr Ken Pridgen & Prof Partners Pty Ltd			
MARY S GAGLIARDI*† Clorox Servs Co	SANDRA KOLBY* Bentley Prince Street	MIR A QUDDUS* Whirlpool			
KAREN F GASKINS Datacolor	CHRISTINE M LADISCH Purdue Univ	JANE H REESE*† Microscal Ltd			
BARBARA M GATEWOOD Kansas State Univ	ROBERT K LATTIE SDL Atlas LLC	JANETT RICE* Intertek			
GREGORY D GEORGE* Innovative Chem Tech Inc		BARRY B RYBNY Yorkshire Americas Inc			
JAYAKUMAR GOPALAKRISHNAN Global Resources Management Grp					

A CHANDLER SCHMALZ
A C Schmalz & Assoc
RICHARD SLOMKO*
Atlas Weathering Svs Grp
SHAWN A SMITH*†
Guilford Mills
SAMUEL W STEVENSON
Textile Consultants
L KENT SUDDETH
Independent Textile
Testing Service Inc
FUJIO SUGA*
Suga Testing Instruments
Co Ltd

NAGAICHI SUGA
Suga Testing Instruments
Co Ltd
CHARLES D SWEENEY
CDS Laboratories Inc
W FRANK TAYLOR
CHARLES E TEMPLER*†
Microscal Ltd
MARK J TEMPLER*†
Microscal Ltd
ERNEST R TURNER
Mohawk Ind

ADAM R VARLEY
Vartest Int'l Inc
WILLIAM S VOGEL
Lantal Textiles Inc
MAX A WEAVER
JERRY T WRIGHT JR*
Shaw Ind
CHARLES ZHU*
SDL Atlas Shanghai
YONG ZHU
Procter & Gamble
TIM ZIEGENFUS
Advanced Testing
Instruments Corp

CAROLYN A MALONE*†
Amoco Fabrics & Fibers
Co
ELIZABETH G
MCFARLAND
Invista
E KENNETH
MCINTOSH*†
Carpet & Rug Inst
HAMIR D MERCHANT*†
Takata Inc
CAREY R MITCHELL*
Shaw Ind
RONALD A F MOORE*†
Honeywell Tech Ctr
MICHAEL NUNNEY*†
British Carpet Technical
Ctr
SUSAN C PACOCHA*†
JCPenney Co

GREG PHILLIPS
Professional Testing Lab
Inc
DAVID L RAMEY
Microban Products Co
SUNDAR MOHAN RAO*
Invista
WILLIAM A REARICK
Cotton Inc
JAMES E RODGERS III*
SRRC ARS USDA
EDITH F SANFORD
JCPenney Co
MICHAEL B SETHNA*†
Mohawk Ind
PAT A SLAVEN
Consumers Union
BORYS SOROKOPUD*
DuPont Canada Inc
SAMUEL W STEVENSON
Textile Consultants

L KENT SUDDETH
Independent Textile
Testing Service Inc
MICHAEL S SUITER
Honeywell Nylon
WAYNE C TINCHER
Georgia Inst of
Technology
ERNEST R TURNER
Mohawk Ind
R CARROLL TURNER
Carpet and Rug Inst
ROLAND A VIERRA
Roland A Vierra & Assoc
CYNTHIA C WOODSON*†
Interface Flooring Systems
Inc
JERRY T WRIGHT JR*
Shaw Ind
TIM ZIEGENFUS*
Advanced Testing
Instruments Corp

RA56 Stain Resistance Test Methods

Scope: To develop test methods for evaluating the resistance of apparel fabrics to stain, to study the phenomenon of soil deposition on apparel fabrics of various fibers and finish types during laundering, and to study the soiling of apparel fabrics in service with the intent of developing a test method. Test Methods 118, 130, 151, 193.

Chair

BILL KIMBRELL '03
Milliken & Co

Secretary

JUSTINE G FRANCHINA
DuPont Chem Co

JESSICA ANN*
Milliken & Co
KERRI BRACKEN*†
Daiken America Inc
DONALD WADE
BURGESS
Nano-Tex LLC
GULTEKIN CELIKIZ
TIMOTHY SCOTT CRUMP
Sara Lee Activewear
VITA R DEAN
Clariant Corp
ELIZABETH A EGGERT*
Procter & Gamble
HOWELL M EPPERLY
Russell Corp
ASH GANDHI*
Manhattan Products
CESAR H GUERRERO
Gap Inc
MARTIN E GURIAN
DesignTex Grp
ALLEN B HAIRFIELD*
Sara Lee

RICHARD W HAROLD*
Color and Appearance
Consulting LLC
JUDY B HOLDEN
Cotton Inc
PAUL L JOHNSON
3M Co
YESSENIA C JUAREZ*
Eldorado Stone LLC
FAWZL P KORIAL
Handicraft Chem Inc
EDWARD R LAMM JR*
Cotton Inc
MAURICE N LARRIVEE*
US Army Natick Soldier Ctr
MARGIT MACHACEK*†
ANGELA B
MASSENGILL*
Cotton Inc
EDWARD J MCNAMARA
Emco Servs Inc
ROMAN NELSON*†
Sara Lee Knit Products
BRAHAM NORWICK*

EDWARD MAHLON
PERRY
HARRY B POOLE
JAMES W ROTHROCK*†
PAMELA G ROUNDTREE*
Sara Lee
EDITH F SANFORD*
JCPenney Co
RICHARD S SIMONSON
Burlington Ind
ALLEN H SIMPSON
Raitech Inc
ARKADY P SINITSYN
Moscow State Univ
NANCY SPENCE
Dalkin America Inc
ROGER C STEINHAEUER*
KAREN M VOHS
National Textiles
MICHELLE H WATKINS
Invista
TODD M WERNICKE
Procter & Gamble
WANDA DENISE WILKS*
Textile Innovators Corp

RA59 Fibrous Test Materials

Scope: To prepare detailed specifications for AATCC standard test fibers, yarns and fabrics other than colorfastness fading standards; specifications to be developed with the assistance and concurrence of those test method development committees responsible for the test methods in which the standard fibers, yarns or fabrics are used. EP10.

Chair

FERNAND SCHLAEPPI

HSIOU-LIEN CHEN
Oregon State Univ
CAROL GRAHAM*
James H Heal & Co Ltd
MICHELLE E KELLEY*
DeRoyal Textiles

THOMAS A KLAAS
Testfabrics Inc
ROBERT LATTIE*
SDL Atlas LLC
SHAWN P MEEKS*
Testfabrics Inc

LUTHER M MYERS
Textile Innovators Corp
SAMUEL C O UGBOLUE
Univ of Mass
WANDA DENISE WILKS*
Textile Innovators Corp

RA60 Colorfastness to Washing Test Methods

Scope: To develop test methods that will reliably predict the colorfastness of textiles during laundering or mill scouring. Test Method 61, 172, 188, 190.

Chair

ROBB R GARDNER '05
Procter & Gamble

Secretary

ROBERT K LATTIE
SDL Atlas LLC

LUIS M ALMEIDA*
Universidade Do Minho
F POWELL ANDREWS III*
Dillard's
RALPH BESNOY*
PAULETTE BRADFORD
PHYLLIS A BURRIS*†
Woolmark Co Inc
ADI B CHEHNA
Textile Tech Servs
PETER G CHRISTIAN
Bloomsburg Mills
ROBERT B CLEAVER*
PATRICIA C CREWS
Univ of Nebraska
BONNIE J S DUNFORD
Warnaco Technical Ctr
ELIZABETH A EGGERT*
Procter & Gamble
MELISSA ELFERS
Unilever HPC-NA
JUAN A FARAJ
Gildan Activewear
MARY S GAGLIARDI*†
Clorox Servs Co
ASH GANDHI*
Manhattan Products
SANJEEV GANDHI*
Intertek
CAROL GRAHAM*
James H Heal & Co Ltd
CRYSTAL W HARRELL*
Procter & Gamble

LISA B HEPPINGER*†
US Army Natick RD&E Ctr
JAMES V HUBER*†
RAJINI JANARDHAN
Bureau Veritas CPS
KANTI A JASANI
Guilford Mills Inc
NORMA M KEYES*
Cotton Inc
SANDRA KOLBY*
Bentley Prince Street
SUSAN A
KURIOTHOWSKI
US Army Natick Soldier Ctr
KAREN E KYLLO
Intertek
TIMOTHY A LITTLE
Ciba Specialty Chem Corp
JODI B LYNCH
Hosiery Technology Ctr
ANGELA B MASSENGILL
Cotton Inc
SUSAN L MATTER
Nordstrom
LEWIS F MCINTYRE SR*
Yorkshire Americas Inc
STEPHEN E MINTER*
Ciba Specialty Chemicals
Corp
JOHN L MORRIS*†
Technicare Servs Ltd
KAREN M MUESER
RODRIGO OLMEDO
Detertec SA

RONALD J PACHECO*
Specialized Technology
Resources
EDGAR J PAGE
HARRY B POOLE
JAMES W ROTHROCK*†
HARRIE P SCHOOTS
Rohm and Haas Co
CHERRY M SEARLE
Buffalo State College
GENEVIEVE M SMITH
LAURA A SPINDEN
DuPont Chem Solutions
ROGER C STEINHAEUER
SAMUEL W
STEVENSON*
Textile Consultants
ROBERT L STUTZ
KULDEEP SULTAN
Alpha Processing Co Ltd
CHARLES R TROMMER
REMBERT J TRUESDALE
III
Southern Mills Inc
KRISTINA K UNDERLY
Whirlpool Corp
WILLIAM S VOGEL
Lantal Textiles Inc
NODIE M WASHINGTON*
Procter & Gamble
WANDA DENISE WILKS*
Textile Innovators Corp
DIANA A WYMAN

RA57 Floor Covering Test Methods

Scope: To develop test methods that will reliably predict the use characteristics of all types of floor coverings. Test Methods 121, 122, 123, 137, 138, 165, 171, 175, 189.

Chair

THOMAS H PERRY JR '04
Dow Chem Co

Secretary

ALAN F BUTTENHOFF
Shaw Ind

JESSICA ANN
Milliken & Co
PATRICIA A ANNIS
Univ of Georgia
ALAN B ATHEY
Jaba Assoc
EDWARD B BALDWIN JR
LINDA C BELL*†
Hoechst Celanese Corp
MICHAEL E BELL*
Mohawk Ind
C MICHAEL BRIGMAN*
Honeywell Nylon
ROBERT C BUCK*
DuPont Co
NICK J CHRISTIE
Global Textile Chem Tech
Consultants
VIJAY B DESAI*
Shaw Ind

JOYCE DOUGLAS*†
Springs Ind
HELEN H EPPS*
Univ of Georgia
THOMAS FABIAN
Underwriters Labs Inc
ROBERT J
FENSTERHEIM*†
SBLC/EPC/APERC
JUSTINE G FRANCHINA
DuPont Chem Co
HARRY M FRY
GREGORY D GEORGE*
Innovative Chem Tech Inc
KAY S GRISE
Florida State Univ
JOHN H HALL JR*†
Shaw Ind
KAREN A HAMILTON*†
Cotton Inc
DALE A HANGEY*
WILLIAM D HANRAHAN
Microban Products Co

PAUL W HARRIS*
W L Gore & Assoc
SALLY HASSELBRACK
MICHEL A HERLANT
JUDY B HOLDEN*
Cotton Inc
DAVID H HOLLAND
JAMES G HOUGH
Reichhold Chems
FAISAL ISLAM*†
Chemspec Inc
YESSENIA C JUAREZ*
Eldorado Stone LLC
HARVEY KATZ
HKI Inc
BRANDON S KERSEY
Mannington Commercial
Carpet
SANDRA KOLBY
Bentley Prince Street
EUGENE MADDOX*
Mohawk Ind

* Nonvoting
† Nonmember AATCC

RA61 Appearance Retention Test Methods

Scope: To develop test methods for evaluating the appearance of durable press fabrics and component parts and the evaluation of complete garments. Test Methods 66, 88B, 88C, 124, 128, 143.

<i>Chair</i>	<i>Secretary</i>
JAMIE E MOAK '03 Procter & Gamble	LOUANN SPIRITO SGS US Testing Co Inc
F POWELL ANDREWS III Dillard's	NANCY E HOBBS† Town & Country Living
JESSICA ANN* Milliken & Co	JUDY B HOLDEN* Cotton Inc
MARY V BARNABAS*† Fabric & Hard Surface Tech	PAMELA J JACO Springs Ind
PHYLLIS A BURRIS*† Woolmark Co Inc	KANTI A JASANI* Guilford Mills Inc
ADI B CHEHNA* Textile Tech Servs	NORMA M KEYES Cotton Inc
HYUNG-MIN CHOI Soongsil Univ	KAREN E KYLLO Intertek
ROBERT B CLEAVER	MAURICE N LARRIVEE* US Army Natick Soldier Ctr
BONNIE J S DUNFORD Warnaco Technical Ctr	MARGIT MACHACEK*†
KUANJUN FANG Qingdao Univ	SUSAN L MATTER Nordstrom
CRYSTAL W HARRELL* Procter & Gamble	JOHN L MORRIS*† Technicare Servs Ltd
ERIC F HEQUET Texas Tech Univ	GLENN P MORTON*†

RA63 Water Resistance, Absorbency and Wetting Agent Evaluation Test Methods

Scope: To develop test methods for evaluating the water resistance, absorbency and effects of wetting agents on textiles. Test Methods 22, 35, 42, 70, 79, 127.

<i>Chair</i>	<i>Secretary</i>
LUISA D SANTOS '04 US Army Natick Soldier Ctr	RICHARD S SIMONSON Burlington Ind
JESSICA ANN* Milliken & Co	CESAR H GUERRERO Gap Inc
JIMM C BARBERY Apollo Chem Co	BARRY T HAUCK*† US Army Natick RD&E Ctr
NOELIE R BERTONIERE* USDA SRRC	PETER J HAUSER NC State Univ
KERRI BRACKEN*† Daiken America Inc	MICHAEL O HUNT JR DIANE T IRVINE US Customs Lab
PATRICK J BRENNAN* Q-Panel Lab Products	MUKESH K JAIN† W L Gore Assoc
HAROLD M BROWN MB Textile Consultants Inc	PAUL L JOHNSON 3M Co
JOHN E BRYANT*† Phoenix Chem Co Inc	SEYMOUR G KARNES* NORMA M KEYES* Cotton Inc
DONALD WADE BURGESS Nano-Tex LLC	ROBERT K LATTIE* SDL Atlas LLC
BRADLEY J BUSHMAN Standard Textile Co Inc	YI LI Hong Kong Polytechnic Univ
FRED L CLARY Florida State Univ	GARY C LICKFIELD Clemson Univ
ALVIN D DELMAN	JODI B LYNCH Hosiery Technology Ctr
WADE H DYSON JR Genencor Int'l Inc	CARLA L MACCLAMROCK* Cotton Inc
THOMAS FABIAN Underwriters Labs Inc	MATTHEW T MARSHALL Carole Hochman Designs Inc
ROBERT J FENSTERHEIM*† SBLC/EPC/APERC	VIKKI B MARTIN* Cotton Inc
JUSTINE G FRANCHINA DuPont Chem Co	GREGORY L MCCRAW Clariant Corp
GREGORY D GEORGE* Innovative Chem Tech Inc	

* Nonvoting
† Nonmember AATCC

RA64 Weather Resistance Test Methods

Scope: To develop test methods for determining or predicting resistance of textile materials to degradation when exposed to indoor and outdoor environments. Test Methods 111, 169, 186, 192.

<i>Chair</i>	<i>Secretary</i>
JESSICA ANN '04 Milliken & Co	PATRICK J BRENNAN Q-Panel Lab Products
DAVID S BURNHAM† ILC Dover	ROBERT K LATTIE* SDL Atlas LLC
RAYMOND A CASPER*† HELEN H EPPS Univ of Georgia	TIMOTHY A LITTLE* Ciba Specialty Chem Corp
SANJEEV GANDHI Intertek	ELIAS ABADULLA MAMMA*
BARBARA M GATEWOOD* Kansas State Univ	MARY A MOORE Florida State Univ
JAMES V HUBER*† SUSAN A KURIOTHOWSKI* US Army Natick Soldier Ctr	RODRIGO OLMEDO Detertec SA
MAURICE N LARRIVEE* US Army Natick Soldier Ctr	ROBERT A POLETTI Performance Coatings
	RICHARD SLOMKO Atlas Weathering Svs Grp

RA66 Mercerization Test Methods

Scope: To serve as a source of information and assistance for those using AATCC Test Method 89, Mercerization in Cotton; to study and possibly develop new test methods that may be more applicable to the textile industry; and to keep the industry aware of developing technology and machinery for mercerization. Test Method 89.

Acting Chair
MARY D ANKENY
Cotton Inc

WADE H DYSON JR
Genencor Int'l Inc

RA70 Yarn Dyeing Technology

Scope: To promote and encourage active participation with discussion on current problems in yarn dyeing technology by members of AATCC whose primary interest is in the field of application of dyes and chemicals; to share as a clearinghouse for information and to provide increased technical knowledge for the benefit of individuals and groups in the textile industry.

<i>Acting Chair</i>	<i>Secretary</i>
EDGAR L SELF II Unifi Inc	ALAN D CORRELL National Spinning Co
DON A ALEXANDER Guilford Mills Inc	BRIAN D GRIFFIN Valdese Weavers LLC
VINCENT W BANNIGAN JR	ROBERT G HARRIS*† Joan Fabrics
RALPH BESNOY BARRY P BRADY	WINFRIED T HOLFELD Aeonica Color Tech
GORDON H BROOME RALPH H CARSON*† Forstmann & Co	CHARLES M HORNE HONEX
MICHAEL V CARTER Spectrum Dyed Yarns Inc	ABDULHALIK ISKENDER Univ of Uludag
NABIL N CHACKAL*† Carisbrook Yarns	STEVE C JAMES†
NICK J CHRISTIE Global Textile Chem Tech Consultants	SANDRA L JOHNSON* Ciba Specialty Chems
STEVEN D DANIELS Chatham Inc	KATHLEEN JONES*† Burlington Ind
PETER J DOLBY DON C DUGGAN	SANDRA KOLBY Bentley Prince Street Chatham Inc
ROBERT G ELLIS JOHN C FARMER Micro Serv Grp Inc	EUGENE MADDOX* Mohawk Ind
WILTON C FINCH M Dohmen USA Inc	RACHEL A MARQUARDT* Alexander Fabrics
KAREN F GASKINS Datacolor	DOUGLAS R MARTIN†
GREGORY D GEORGE Innovative Chem Tech Inc	WILLIAM D MCGILL*† Gaston Co Dyeing Machine Co
JERRY R GOODSON*† Fieldcrest Cannon Inc	VINCENT A MONFALCONE III Levolor-Kirsch Window Fashions
	BERNARD P OLSZOWY DONALD R PRICE† Wastewater Solutions
	THOMAS R PRIEST Ciba Specialty Chems Corp
	DANIEL E SHELTON* Ciba Specialty Chems Corp
	WILLIAM E SINGLETON* Grover Ind
	CHUNG SUN SUH Suh & Assoc
	PHILIP A THOMPSON† Mariplast North America
	SUSAN G TOBIN* Rite Ind
	ROBERTA M TREMAIN WILLIAM E TRENT III Southeastern Chem Corp
	CHARLES R TROMMER
	DAVID R VLASERVICH Abercrombie & Fitch
	ROBERT L WARD JR
	ROBERT L WASHINGTON*† Ethicon Inc
	CH ZAH* Interface Inc

RA71 Hosiery Test Methods

Scope: To develop test methods that will reliably predict the use characteristics of all types of hosiery products.

<i>Chair</i> JODI B LYNCH '05 Hosiery Technology Ctr	<i>Secretary</i> JOHN F SIMON Neuville Ind	
RUTH A ARSENEUE J Arsenue Enterprise	SALLY KAY*† NAHM	LARISA SHEVELEVA*† Regal Mfg/Worldtex
JIMM C BARBERY Apollo Chem Co	AMY S Y LEE Intertek	SID SMITH*† NAHM
ARTHUR C CALDWELL III* S&W Chems Inc	JACK D MADREN LUTHER M MYERS Textile Innovators Corp	FUJIO SUGA Suga Testing Instruments Co Ltd
ADI B CHEHNA* Textile Tech Servs	ROBIN A NORTON*† Nordstrom	HAROLD C WALLER† Wigwax Mills Inc
NORMAN R DEMERS Konica Minolta	CHERRY M SEARLE* Buffalo State College	ROMAN D YEFREMOV*† Regal Mfg/Worldtex
PETER J FRANDSEN Gold Toe Brands Inc	JUANYEL J SHERIDAN*† Hosiery Technology Ctr	TIM ZIEGENFUS Advanced Testing Instruments Corp

RA73 Warp Size Technology

Scope: To promote and encourage active participation by discussion on current problems in warp size technology by members of AATCC; to serve as a clearinghouse for information and to provide increased technical knowledge for the benefit of individuals and groups in the textile industry as related to classification, application and removal of size.

<i>Chair</i> JOHN C LARK '04	<i>Secretary</i> BART L HEDRICK† Celanese Chems	
TAK MING MAN* Bodycote Ortech Corp	JAMES E MORELAND Lamberti USA Inc	CHARLES D STEWART* Seydel-Woolley & Co
HARRY L MERCER Indigo Blue	WARREN S PERKINS GEORGE D ROBINSON DuPont	JAYSON C VASSALLO PhilChem

RA75 Correlation of Laboratory Tests with End-Use Performance

Scope: To encourage discussions of problems arising in conjunction with the measurement of end-use performance characteristics; to point out where new or improved test methods are needed to provide more accurate measurement of end-use performance of fabrics and to conduct literature surveys; to consider the effects of multiple factors upon fabric performance; to make recommendations to the chair of the Technical Committee on Research, as appropriate.

<i>Acting Chair</i> ELIZABETH A EGGERT Procter & Gamble	<i>Secretary</i> JOSEPH J NILSEN DSCP DLA	
GEORGE C ANDERSON Pendleton Woolen Mills	VIVIAN E DAVIS MYLUE T DO MARVEL	NANCY J JOHNSON* Clorox Co
F POWELL ANDREWS III Dillard's	QING S DUNCAN Swiss Tex California	MICHELLE E KELLEY* DeRoyal Textiles
ALAN B ATHEY Jaba Assoc	BONNIE J S DUNFORD Warnaco Technical Ctr	NORMA M KEYES Colton Inc
CHI K AU Ocean Lanka Pvt Ltd	ELIZABETH P EASTER Univ of Kentucky	RICHARD E KIMBLE Kintex Laboratories Inc
MARY V BARNABAS*† Fabric & Hard Surface Tech	ANDREW V FARLEY* PRISCILLA S FOX Dial Corp	V KENNETH KISER III Apparel Testing Servs
BURTON BLAGMAN ARTHUR C CALDWELL III S&W Chems Inc	MARY S GAGLIARDI*† Clorox Servs Co	COLON R KNIGHT Tietex Interiors
ADI B CHEHNA Textile Tech Servs	RUTH L GALBRAITH*† Auburn Univ	SANDRA KOLBY Bentley Prince Street
HSIOU-LIEN CHEN Oregon State Univ	BARBARA M GATEWOOD Kansas State Univ	AMY S Y LEE* Intertek
PETER G CHRISTIAN Bloomsburg Mills	MARTIN E GURIAN DesignTex Grp	YI LI* Hong Kong Polytechnic Univ
ROBERT B CLEAVER LAURANCE G COFFIN	IAN R HARDIN Univ of Georgia	JEE HWAN LIM*† Taiheung
STEVEN G COLLINS*† Milliken & Co	CRYSTAL W HARRELL* Procter & Gamble	JOHN F MASTBETH*† LANA M MCCAFFREY
SARAH L COWAN PATRICIA C CREWS Univ of Nebraska	BARRY T HAUCK*† US Army Natick RD&E Ctr	IRENE B MILLER* Intertek
JOHN A DARSEY JR Color Solutions Int'l	JULIE A HILL*† Chemtex Inc	KAREN M MUESER IOAN I NEGULESCU Louisiana State Univ
	NANCY E HOBBS*† Town & Country Living	BRAHAM NORWICK ANNE PATTERSON*† Simon Paterson Assoc Inc
	KANTI A JASANI Guilford Mills Inc	

* Nonvoting
† Nonmember AATCC

NANCY E PEBENITO* Nike	LUISA D SANTOS US Army Natick Soldier Ctr	LOUANN SPIRITO SGS US Testing Co Inc
CHARLES D QUIRK Rohm & Haas Co	AJOY K SARKAR Colorado State Univ	ROGER C STEINHAUER ODALIS A TEJADA Tommy Hilfiger USA
DAVID L RAMEY Microban Products Co	MAJID SARMAZI Univ of Wisconsin	MARY J THOMPSON*† Brigham Young Univ
RONA L REID Dow Chem Co	PETER SCHWARTZ Auburn Univ	SAMUEL C O UGBOLUE Univ of Mass
JANETT RICE Intertek	THOMAS P SCOTT JR ANUGRAH SHAW Univ of Maryland-Eastern Shore	ELLEN R YUENCO GAP Inc
CHARLES L RIGGS Texas Woman's Univ	RICHARD SLOMKO Atlas Weathering Svs Grp	NODIE M WASHINGTON* Procter & Gamble
HEATHER E ROBERTSON Govmark Organization Inc	GENEVIEVE M SMITH MARY-ELLEN SMITH*† Nike	MANFRED WENTZ Textile Care Int'l (TCI) Ltd
JAMES W ROTHROCK*† EDITH F SANFORD* JCPenney Co		FREDERICK E WILSON III Dooley Chems
		YIQI YANG* Univ of Nebraska-Lincoln

RA76 Flock Technology

Scope: To coordinate and direct the planning of technical programs of special interest to individuals and groups concerned with flock technology; to act as a clearinghouse for information on flock technology for members of AATCC.

<i>Chair</i> To Be Designated	<i>Secretary</i> To Be Designated	
JUDITH M BARRON*† Springs Ind	SOLOMON P HERSH LEOPOLDO A JOHNSON C L Hawthaway & Sons	HEATHER E ROBERTSON* Govmark Organization Inc
LORI J BERNARD*† Intermark Flock Corp	GEORGE C KANTNER RONALD J KERR*	RAYMOND E SILVA JR Z-TEX
RHODERICK R BLUE THEODORE A DELONNO Omnova Solutions Inc	DILIP L PATEL*† ROBERT A POLETTI* Performance Coatings	LEON O WINSTROM*† Malden Mills

RA79 Coated, Bonded and Laminated Fabrics Test Methods

Scope: To develop test methods for evaluating the effects of multiple laundering or drycleaning on bonded, laminated or coated fabrics. To promote and encourage the investigation, study and discussion of problems associated with coated, bonded and laminated fabrics. To promote and coordinate technical programs of special interest to individuals and groups concerned with coated, bonded and laminated fabrics; to serve as a forum for information related to the technology of coated, bonded and laminated fabrics. Test Method 136.

<i>Chair</i> HARRY S SPARROW '03 Rohm & Haas Co	<i>Secretary</i> D C PATEL	
JESSICA ANN* Milliken & Co	CHARLES L GRIFFIN* Griffin & Assoc	CHRISTOPHER J PENTHENY US Army Natick R&D Labs
RHODERICK R BLUE JANACE E BUBONIA- CLARKE Texas Christian Univ	MARGUERITA C HINDLE TCE Consulting Service	EDWARD MAHLON PERRY
GEORGE S BUCK JR DAVID S BURNHAM† ILC Dover	CONNIE P HOWE*† Reichhold Chems	ROBERT A POLETTI Performance Coatings
BRADLEY J BUSHMAN Standard Textile Co Inc	PAMELA J JACO* Springs Ind	GUO-WEI QIN† Tex-Tenn Corp
PETER G CHRISTIAN Bloomsburg Mills	MUKESH K JAIN*† W L Gore Assoc	WAYNE D ROCKWELL* SIDDHARTHA SENGUPTA*† Univ of Calcutta
DEBRA F CHRONICLE M Dohmen USA Inc	LEOPOLDO A JOHNSON C L Hawthaway & Sons	RAYMOND E SILVA JR Z-TEX
RICHARD DOBROWOLSKI* Rohm and Haas Co	SEYMOUR G KARNES RONALD J KERR SUNDARAM KRISHNAN Raffi and Swanson Inc	RICHARD S SIMONSON* Burlington Ind
RONALD R DOMBROWSKI TechTex Solutions Inc	AMY S Y LEE Intertek	CHARLES A SMITH*† Pellon Corp
THOMAS FABIAN* Underwriters Labs Inc	WALTER L MAGEE*† Wacker Silicones Corp	MARY-ELLEN SMITH*† Nike
LORRAINE A GALICA*† American Fiber & Finishing Inc	TAK MING MAN* Bodycote Ortech Corp	SAMUEL G THOMAS JR*†
SANJEEV GANDHI* Intertek	MATTHEW T MARSHALL Carole Hochman Designs Inc	RODNEY J TRAHAN JR* Mallard Creek Polymers Inc
JANICE R GERDE* US Bureau of Customs & Border Protection	EDWARD J MCNAMARA Emco Servs Inc	BLAIR D TRASK Omniflex
TONY C GOWAN Symtech Inc	JOHN J O NEIL DHARNIDHAR V PARIKH USDA SRRC	RONALD W ULMSCHNEIDER Soluol Chem Co Inc
	DILIP L PATEL*† ROBERT E PELLETIER† Duro Ind	REIYAO ZHU† Texas Tech Univ
		YONG ZHU* Procter & Gamble

RA80 Printing Technology

Scope: To promote, coordinate and encourage technical programs of special interest to individuals and groups concerned with printing and to provide increased technical knowledge.

<i>Chair</i>	<i>Secretary</i>	
MICHAEL E COMPTON '05 DuPont Ink Jet	To Be Designated	
MARY D ANKENY Cotton Inc	JULIE A HILL*† Chemtex Inc	STEPHEN M RUZIECKI Yorkshire Americas Inc
DANIEL J ARDITO	ABDULHALIK ISKENDER Univ of Uludag	A CHANDLER SCHMALZ A C Schmalz & Assoc
MICHAEL J ARMITAGE Workrite	PAMELA J JACO Springs Ind	HANS PETER SCHOEPLIN
JOSEPH F BURNS*† Surf Action Organics Inc	ROBERT J LASEK*† Decorative Screen Printers	JAYANT K SHAH*† Guilford Mills
MICHAEL S CALLAHAN*† Harodite Finishing Co Inc	MARGIT MACHACEK*†	SHAWN A SMITH*† Guilford Mills
WILLIAM CARDOZO Bolger and O'Hearn	RICHARD A MALACHOWSKI Cranston Print Works Co	SAMUEL W STEVENSON Textile Consultants
CASEY K CHANDRASEKARAN*† DuPont	TAK MING MAN Bodycote Ortech Corp	FLETCHER S STONE JR F S Stone Application Tech Inc
NICK J CHRISTIE Global Textile Chem Tech Consultants	SHAWN P MEEKS Testfabrics Inc	JOYCE B STOREY JOSEPH M STROTHER Pillowtex Corp
DEBRA F CHRONICLE M Dohmen USA Inc	JAY R MISTRY* EcoTech Products Inc	CHUNG SUN SUH Suh & Assoc
RICHARD J COWAN*	BOBBY L NEAL Organic Dyestuff Corp	DANIEL S THOMPSON*† Sunbelt Corp
T AVON FULLER*† Pottsville Bleaching & Dyeing	JOHN W OGLETREE JR Polychem	CHARLES L TIGHE Mega Inc
KAREN F GASKINS Datacolor	BABUBHAI C PATEL IndusCo Ltd	BROOKS G TIPPETT Pantone Inc
BARBARA M GATEWOOD Kansas State Univ	D C PATEL	G THOMAS TRIMBLE JR Ford Trimble & Assoc Inc
GREGORY D GEORGE* Innovative Chem Tech Inc	JIM PRICE Lenmar Chem Corp	WILLIAM S VOGEL* Lantal Textiles Inc
RICHARD W HAROLD* Color and Appearance Consulting LLC	CHARLES D QUIRK Rohm & Haas Co	DANIEL D WARD*† Flynt/Wasona
	JAMES W RUCKER	RONALD E WEBBER*

RA87 Applied Dyeing and Characterization of Dyes Test Methods

Scope: To develop test methods for evaluating the dyeing properties of different dye classes and dyeing systems; to encourage discussions and publications of papers on dyeing theory; and to promote the understanding of modern dyeing theory through symposia, workshops and/or seminars. Test Methods 140, 141, 146, 154, 159, 167, 170, 176, 184.

<i>Chair</i>	<i>Secretary</i>	
FRANK A FUSS '05 MeadWestvaco Corp	LEON S MOSER NC State Univ	
NIKHIL AGRAWAL Unilever HPC USA	GREGORY D GEORGE* Innovative Chem Tech Inc	JAMES E RODGERS III* SRRR ARS USDA
J RICHARD ASPLAND Clemson Univ	PAUL W HARRIS* W L Gore & Assoc	MAJID SARMADI Univ of Wisconsin-Madison
BENNETT R BAIRD Material Science & Innovation LLC	SALLY HASSELBRACK Walmart Stores Inc	LAURA T SCOTT* Walmart Stores Inc
MARTIN J BIDE Univ of Rhode Island	MICHEL A HERLANT Nelson E HOUSER* M Dohmen USA Inc	MARVIN S SHEPARD H Warshaw & Sons Inc
GULTEKIN CELIKIZ	WILLIAM D HUNTER* Hunter Analytical Consulting Svcs	CHARLES W STEWART Tumbling Colors Inc
PETER G CHRISTIAN* Bloomsburg Mills	ABDULHALIK ISKENDER Univ of Uludag	WILLIAM C STUCKEY Coats North America
FRED L COLLINS* M Dohmen USA	MARTIN KORNAUSER	LEO T SULLIVAN UZ Engineered Products
JOHN A DARSEY JR Color Solutions Int'l	KLAUS J MACKERT*	CHARLES D SWEENEY CDS Laboratories Inc
JOSEPH DIWAN Sara Lee Branded Apparel	EUGENE MADDOX Mohawk Ind	BROOKS G TIPPETT Pantone Inc
MYLUE T DO MARVEL Sale	GARY N MOCK* NC State Univ	CHARLES R TROMMER
QING S DUNCAN Swiss Tex California	VINCENT A MONFALCONE III Levolor-Kirsch Window Fashions	REMBERT J TRUESDALE III Southern Mills Inc
WILTON C FINCH M Dohmen USA Inc	ROOP C NAHTA	WILLIAM S VOGEL Lantal Textiles Inc
BARBARA M GATEWOOD Kansas State Univ	WARREN S PERKINS*	JIPING WANG Procter & Gamble
	LOUIS T PROTONENTIS Cotton Inc	MANFRED WENTZ Textile Care Int'l (TCI) Ltd
	LEANDER B RICARD	CH ZAH* Interface Inc

* Nonvoting
† Nonmember AATCC

RA88 Home Laundering Technology

Scope: To encourage and promote discussions on current developments and problems associated with the use of standard and new chemical materials, including soaps and detergents, bleaches, water and fabric softeners, enzymes and any other auxiliaries available to the consumer for use in home laundering and coin-operated machines, which may affect color, performance and special functional finishes and the ecology. The information gathered by this committee will be directed to the attention of specific AATCC research committees for their use and orientation. Where appropriate, this committee will plan technical programs and will serve as a clearinghouse for the dissemination of information on this subject area.

<i>Chair</i>	<i>Secretary</i>	
NODIE M WASHINGTON '04 Procter & Gamble	NIKHIL AGRAWAL Unilever HPC USA	
JESSICA ANN Milliken & Co	PETER J HAUSER NC State Univ	RODRIGO OLMEDO Detertec SA
DANIEL J ARDITO	JUDY B HOLDEN Cotton Inc	ADETOMIWA ADETUNJI OPAFOLA† Aptitude Investment Ltd
RUTH A ARSENEUE J Arsenue Enterprise	KERMIT W HOLSHOUSER Hickory Yarns	NANCY E PEBENITO Nike
CHI K AU Ocean Lanka Pvt Ltd	RAJINI JANARDHAN* Bureau Veritas CPS	MICHAEL D PEEBLES BSH Home Appliances Corp
BURTON BLAGMAN	KANTI A JASANI* Guilford Mills Inc	HARRY B POOLE
GEORGE L BRODMANN	NANCY J JOHNSON* Clorox Co	MIR A QUDDUS* Whirlpool
DONALD WADE BURGESS Nano-Tex LLC	PAUL L JOHNSON 3M Co	JANETT RICE* Intertek
ADI B CHEHNA Textile Tech Servs	NORMA M KEYES* Cotton Inc	CHARLES L RIGGS Texas Woman's Univ
HSIOU-LIEN CHEN Oregon State Univ	SANDEEP KHATUA Bureau Veritas CPS Inc	HEATHER E ROBERTSON Govmark Organization Inc
ROBERT B CLEAVER	FAWZL P KORIAL Handicraft Chem Inc	THOMAS P SCOTT JR
RICHARD C DAVIS	KAREN E KYLLO Intertek	ALLEN H SIMPSON* Raitech Inc
ELIZABETH P EASTER Univ of Kentucky	R BRUCE LEBLANC	ARKADY P SINITSYN Moscow State Univ
ELIZABETH A EGGERT* Procter & Gamble	MARGIT MACHACEK*†	PAT A SLAVEN Consumers Union
HELEN H EPPS Univ of Georgia	TAK MING MAN Bodycote Ortech Corp	GENEVIEVE M SMITH
PRISCILLA S FOX Dial Corp	ANGELA B MASSENGILL* Cotton Inc	ROGER C STEINHAUER
MARY S GAGLIARDI*† Clorox Servs Co	JOHN F MASTBETH*†	MARY J THOMPSON*† Brigham Young Univ
RUTH L GALBRAITH*† Auburn Univ	STEPHEN E MINTER Ciba Specialty Chemicals Corp	KRISTINA K UNDERLY Whirlpool Corp
ASH GANDHI* Manhattan Products	KAREN M MUESER	ANN E WEAVER† 3M Co
CHARLES L GRIFFIN* Griffin & Assoc	CRYSTAL W HARRELL* Procter & Gamble	WANDA DENISE WILKS* Textile Innovators Corp
	LUTHER M MYERS Textile Innovators Corp	
	BRAHAM NORWICK	

RA89 Hand Evaluation Test Methods

Scope: To develop specialized test methods and terminology for the assessment and description of differences in the hand of fabrics. Test Method EP5.

<i>Chair</i>	<i>Secretary</i>	
NORMA M KEYES '04 Cotton Inc	To Be Designated	
JESSICA ANN* Milliken & Co	BILLIE J COLLIER Univ of Tennessee	SESHADRI S RAMKUMAR Texas Tech Univ TIEHH
EDGAR CHAMBERS IV*† Kansas State Univ	JUAN A FARAJ Gildan Activewear	GUOWEN SONG Univ of Alberta
YAN CHEN Louisiana State Univ	YI LI Hong Kong Polytechnic Univ	

RA90 Chelating Agent Evaluation Test Methods

Scope: To develop test methods for the evaluation of chelating agents for use in textile wet processing. Test Methods 149, 161, 168, 185.

<i>Chair</i>	<i>Secretary</i>	
RICHARD A BARNHARDT '04 Apollo Chem Corp	To Be Designated	
RICHARD O BROWN BGB Stockhausen	JAMES E GREGSON JR*† Dan River Inc	YOUSSEF H ISMAEIL Pantone Inc
WADE H DYSON JR Genencor Int'l Inc	JOHN H HALL JR*† Shaw Ind	ROBERT J JONES JR Cognis Corp
HAROLD K GREESON JR Cotton Inc	MICHEL A HERLANT	FAWZL P KORIAL* Handicraft Chem Inc

DHARNIDHAR V PARIKH
USDA SRRC
KEVIN S PEELE*†
Color-Tex Finishing
JAMES W RUCKER

DENNIS C SCHEER
Polo Ralph Lauren
JOSEPH M STROTHER
Pillowtex Corp

WILLIAM E TRENT III
Southeastern Chem Corp
YONG ZHU
Procter & Gamble

RA102 Statistics Advisory

Scope: To provide assistance in statistical methodology to Research and Technology Committees, to provide guidelines for the use of correct statistical practices and terminology in the development of new test methods and revisions of existing test methods, and to review precision and bias statements in published test methods.

Acting Chair
L KENT SUDDETH
Independent Textile Testing
Service Inc

Secretary
To Be Designated

ROBERT B CLEAVER
BILLIE J COLLIER
Univ of Tennessee
MELISSA ELFERS
Unilever HPC-NA
HOWELL M EPPERLY
Russell Corp
J NOLAN ETTERS

SANJEEV GANDHI*
Intertek
KAREN F GASKINS*
Datacolor
YESSENIA C JUAREZ*
Eldorado Stone LLC
SANDRA KOLBY
Bentley Prince Street
KENNETH D LANGLEY
Univ of Mass Dartmouth

P EUGENE MADDUX*†
MELANIE C RIMMER*
Croskill Inc
RUSSELL J RUGGIERI
Seydel Woolley & Co
WILLIAM S VOGEL
Lantal Textiles Inc
REIYAO ZHU†
Texas Tech Univ

RA99 Technical Manual Editorial Review

Scope: To maintain the test method style manual; to review all new and existing test methods for compliance with the style manual, clarity of thought and technical consistency between methods; to recommend layout and content changes for the TECHNICAL MANUAL that primarily affect its ease of use.

Chair
ADI B CHEHNA
Textile Tech Servs

NIKHIL AGRAWAL
Unilever HPC USA
LEANDER B RICARD

GENEVIEVE M SMITH

ADAM R VARLEY
Vartest Int'l Inc

RA100 Safety, Health and Environmental Technology

Scope: To disseminate and exchange knowledge on current developments and industry practice in the fields of human health, product safety and the environment for the textile and its supplier industries; and to provide a forum for discussion of related federal and state legislation, and rules and regulations of government agencies.

Chair
HENRY A BOYTER JR '04
Inst of Textile Tech

Secretary
JOSEPH J NILSEN
DSCP DLA

DON A ALEXANDER
Guilford Mills Inc
THOMAS A ALSPAUGH
ROBERTA N ALTMAN
Clariant Corp
WILLIAM F BAITINGER
Westex Inc
EARL J BALL
GEORGE L
BAUGHMAN*†
Univ of Georgia
MARTIN J BIDE
Univ of Rhode Island
GEORGE S BUCK JR
SEAN P CADY
Levi Strauss & Co
PETER G CHRISTIAN
Bloomsburg Mills
ROBERT B CLEAVER
BILLIE J COLLIER
Univ of Tennessee
MARIA D CRIVELLO*
US Army
GARY S DAGENHART*
Clariant Corp
LEONARD T FARIAS
Cotton Inc
ROBERT J
FENSTERHEIM*†
SBL/C/EPC/APERC
MARTIN FERUS-
COMELO*
Leeds Univ
GEOFFREY
GETTLIFFE*†
Swift Denim
D PAGE HENDERSON*†
Gerber Childrenswear Inc

JULIE A HILL*†
Chemtex Inc
MARGUERITA C HINDLE
TCE Consulting Service
YOUSSEF H ISMAEIL
Pantone Inc
KANTI A JASANI*
Guilford Mills Inc
MICHELLE E KELLEY*
DeRoyal Textiles
STEWART E KLEIN
Sanitized Inc
YI LI
Hong Kong Polytechnic
Univ
DAVID A MACEWEN
Lanxess Corp
VINCENT J MCKONE SR*
LEO D MONTROY*†
Tetra Tech Inc
BRAHAM NORWICK
RALPH NICK ODOM JR*†
Springs Ind
GILBERT ONEAL*
NC State Univ
SUZANNE F OWENS†
Werner - Gershon Assoc
DONALD R PRICE*†
Wastewater Solutions
GUO-WEI QIN†
Tex-Tenn Corp
JACK I REICH*†
Andco Environmental
Processes
GEORGE D ROBINSON
DuPont
RUSSELL J RUGGIERI
Seydel Woolley & Co

DEBORAH A SAWYER*†
NC Dept Env Hlth & Nat
Res
REX A SCHAD
HARRIE P SCHOOTS
Rohm and Haas Co
RAYMOND E SILVA JR
Z-TEX
C BRENT SMITH*
NC State Univ
MARY-ELLEN SMITH*†
Nike
GUOWEN SONG
Univ of Alberta
WILLIAM C STUCKEY
Coats North America
KULDEEP SULTAN
Alpha Processing Co Ltd
CHARLES D SWEENEY
CDS Laboratories Inc
ELWYN B THOMPSON JR
Sara Lee Corp
ARTHUR J TOOMPAS
Cone Mills Corp
WILLIAM E TRENT III
Southeastern Chem Corp
R CARROLL TURNER
Carpet and Rug Inst
KAY M VILLA
Kay M Villa Consulting Inc
PHILLIP J WAKELYN
Nat'l Cotton Council of Am
ALLEN B WARD*†
RMT Inc
JOAN B WARD
R LEE WAYLAND JR
MAX A WEAVER

RA103 Spectroscopic Technologies

Scope: To promote the advancement of all forms of spectroscopic technologies (NIR, NMR, ultraviolet, visual, IR, Raman, microwave, etc.) by serving as a clearinghouse for information for the benefit of individuals and companies in the textile industry.

Chair
JAMES E RODGERS III '05
SRRC ARS USDA

Secretary
MICHELE L WALLACE
Cotton Inc

KEITH R BECK
NC State Univ
SUNNY A BHAT
Voridian (Eastman
Division)
JEANETTE M
CARDAMONE
USDA ARS ERRC
HYUNG-MIN CHOI
Soongsil Univ
NORMAN R DEMERS
Konica Minolta
JOSEPH DIWAN
Sara Lee Branded
Apparel
LEONARD T FARIAS*
Cotton Inc

SANJEEV GANDHI*
Intertek
SUBHAS GHOSH*†
Inst of Textile Tech
MAX M HOUCK
West Virginia Univ
HUSTON E HOWELL*†
BASF Corp
KAREN E KYLLO
Intertek
LEE F LEMERE
Prism Tech
TAK MING MAN
Bodycote Ortech Corp
NANCY M MORRIS*†
SRRC USDA

IOAN I NEGULESCU
Louisiana State Univ
KENNETH J PIDGEON†
Dr Ken Pridgeon & Prof
Partners Pty Ltd
JAMES W ROTHROCK*†
RUSSELL J RUGGIERI*
Seydel Woolley & Co
JAYANT K SHAH†
WILLIAM C STUCKEY
Coats North America
CHUNG SUN SUH
Suh & Assoc
ADAM R VARLEY
Vartest Int'l Inc

RA104 Garment Wet Processing Technology

Scope: To coordinate and direct technical discussions on current areas of interest in garment dyeing, washing, finishing, and other areas; to provide sources for increased technical knowledge for the benefit of individuals and groups concerned with garment wet processing.

Acting Chair
F POWELL ANDREWS III
Dillard's

Secretary
To Be Designated

GEORGE C ANDERSON
MICHAEL J ARMITAGE
Workrite
PRISCILLA R BAILEY-
PADILLA
Russell Athletic
MARIA E BARAHONA*
Betamatic Corp
CINDY B BELLAMY
Avondale Mills
WALTER H BORTLE*†
General Chem Co
GEORGE L BRODMANN
ALLISON LONDON
BROWN*†
American Garment
Finishers Corp
RICHARD O BROWN
BGB Stockhausen
JOHN E BRYANT*†
Phoenix Chem Co Inc
JOSEPH F BURNS*†
Surf Action Organics Inc
GULTEKIN CELIKIZ
ADI B CHEHNA
Textile Tech Servs

STEVEN G COLLINS*†
Milliken & Co
THOMAS C COX
Amitech
WILLIAM P CREIGHTON
JAY H DAILY*†
Elk-Washer Machinery
WADE H DYSON JR*
Genencor Int'l Inc
JOHN W ENGLESTAD*
UCO Fabrics Inc
KUANJUN FANG
Qingdao Univ
LEONARD T FARIAS*
Cotton Inc
ANDREW V FARLEY*
BARRY L FERGUSON*†
High Point Text Auxiliaries
LLC
MARY S GAGLIARDI*†
Clorox Servs Co
LAWRENCE O
GOLDSTEIN
Glo-Tex Int'l Inc
JOHN T GRAHAM
Levi Strauss & Co

JAN J GREGORY
Ciba Specialty Chems
Corp
GREGORY K HALL
Kimberly-Clark Corp
PETER J HAUSER
NC State Univ
MARGUERITA C HINDLE
TCE Consulting Service
WINFRIED T HOLFELD
Aeonica Color Tech
TOM W
HOLLINGSWORTH
CHARLES M HORNE
HONEX
C DUFF HUGHES JR
Polo Ralph Lauren
RAJINI JANARDHAN
Bureau Veritas CPS
TERRY L JENKINS*†
Vulcan Performance
Chems
AARON F JOHNSON*
Target Corp
FREDERICK K JONES
Northeast Dye
LEON J KELLER JR

* Nonvoting
† Nonmember AATCC

RICHARD E KIMBLE
Kimtex Laboratories Inc
V KENNETH KISER III*
Apparel Testing Servs
FAWLZ P KORIAL
Handicraft Chem Inc
TAM KWOKMANBILLIE
P T Tyfountex Indonesia
KAREN E KYLLO
Intertek
ROBERT K LATTIE*
SDL Atlas LLC
JAMES H LEE
J NED LINDSEY
Avondale Mills
MARGIT MACHACEK*†
TAK MING MAN*
Bodycote Ortech Corp
DONALD R
MARKOFSKI*†
Burlington Ind
O DAVID MARTIN
DuPont
RANDOLPH W MAYLEY
GTI
HAROLD E MCDANIEL
HARRY L MERCER
Indigo Blue
ROBERTO MONTANO
TRAINSA

MARLENE MUELLER†
Novozymes NA Inc
BOBBY L NEAL
Organic Dyestuff Corp
FREDERICK C PAGE
JR*†
In 7 Co
LAURIE D PATRICK
Iogen Corp
MIR A QUDDUS
Whirlpool
JAMES G RAIBORN*
Avondale Mills
AJAY I RANKA
Zydex Ind
RONALD ROLLECK*†
Buffalo Color Corp
JAMES W RUCKER
DENNIS C SCHEER*
Polo Ralph Lauren
GARRETT A SCREWS
JR*
Novozymes NA Inc
SIDDHARTHA
SENGUPTA*†
Univ of Calcutta
JAYANT K SHAH*†
DANIEL B SHOOK
Dyadic Int'l Inc
CHARLES W STEWART
Tumbling Colors Inc

ANTHONY F
STRICKLAND*
Avondale Mills
LARRY W STRICKLAND
Cone Mills Corp
ROBERT F SUTTHOFF
Enzyme Development
Corp
RAJESH S TARI*†
Caretex Exports
RAYMOND E TERRY*†
Fabcare Inc
MARY J THOMPSON*†
Brigham Young Univ
JOSEPH M THORNE*†
Icon Int'l LLC
CHARLES L TIGHE
Mega Inc
JAMES A TRAMMEL
R MICHAEL TYNDALL
Cotton Inc
JIPING WANG
Procter & Gamble
KENNETH R WESP
Clariant
WILLIAM P WILLIS
Willis Consultants
ROBERT J WILSON
Gap Inc

RICHARD SLOMKO
Atlas Weathering Svs Grp
SHAWN A SMITH*†
Guilford Mills
GUOWEN SONG
Univ of Alberta

LOUANN SPIRITO
SGS US Testing Co Inc
ARTHUR W
SPRINGSTEEN
Avian Tech
ADAM R VARLEY*
Vartest Int'l Inc

KEN WEAVER*†
Filament Fiber Tech
YONG ZHU
Procter & Gamble

RA107 Elastic Fabrics Technology

Scope: To coordinate and direct technical discussion on current areas of interest and to identify and address consumer needs as related to elastic fabrics and related technologies.

Acting Chair

GILBERT B ELLERBE
LanXess

Secretary

AMY S Y LEE
Intertek

BENNETT R BAIRD
Material Science &
Innovation LLC

KATHRYN E HUDSON*
CMI Ind Inc

WILLIAM R SILVEIRA
Merchandise Testing Lab
CEVIN BRENT SMITH

WILLIAM E BAIRD JR*
Milliken & Co

TAK MING MAN*
Bodycote Ortech Corp

THOMAS L STEVENS
Southern Weaving Co

DYER M BENNETT
Microfibres Inc

MATTHEW T MARSHALL
Carole Hochman Designs
Inc

LEO T SULLIVAN
UZ Engineered Products

BEN L BRUNER*
Dorlastan Fibers LLC

EDWARD A MILLS*
Darlington Fabrics

KULDEEP SULTAN
Alpha Processing Co Ltd

YAN CHEN*
Louisiana State Univ

IOAN I NEGULESCU
Louisiana State Univ

JAKIE T WELCH
Georgia Narrow Fabrics
Corp

BONNIE J S DUNFORD
Warnaco Technical Ctr

BERNARD P OLSZOWY

DAVID E WENSTRUP*†
Milliken & Co

CHARLES L GRIFFIN*
Griffin & Assoc

ALBERT B OUIMET*
Warnaco Technical Ctr

EDMUND L WHITEMAN*
Milliken Research Ctr

CRYSTAL W HARRELL
Procter & Gamble

CYNTHIA H POOLE*†
Celanese Acetate LLC

ALLISON WHITTLE*†
Unifi Inc

CHARLES A HARYSLAK
Malden Mills Ind Inc

RONA L REID
Dow Chem Co

HOWARD M ZINS*†
Angelica Image Apparel

RONALD W HOLT
National Spinning Co Inc

EYAL J RON
Texollini Inc

RA105 Supercritical Fluid Test Methods

Scope: To develop new test methods utilizing supercritical fluid technology; to promote and encourage the investigation, study and discussion of the utilization of supercritical fluid technology in the textile industry; and to serve as a clearinghouse for information related to this technology.

Acting Chair

MICHAEL J DREWS
Clemson Univ

Secretary

KEITH R BECK
NC State Univ

CHRISTOPH W AURICH
Gaston Systems Inc
SUNNY A BHAT
Vordian (Eastman
Division)

GREGORY D GEORGE*
Innovative Chem Tech Inc
PERRY L GRADY*
NC State Univ

IOAN I NEGULESCU
Louisiana State Univ
JAMES E RODGERS III
SRRC ARS USDA

GEORGE L BRODMANN
ALLISON LONDON
BROWN*†
American Garment
Finishers Corp

WINFRIED T HOLFELD
Aeonica Color Tech

RUSSELL J RUGGIERI
Seydel Woolley & Co

RICHARD O BROWN
BGB Stockhausen
GULTEKIN CELIKIZ*
LEONARD T FARIAS
Cotton Inc

HUSTON E HOWELL*†
BASF Corp

JOSEPH M STROTHER
Pillowtex Corp

WILLIAM D HUNTER*
Hunter Analytical
Consulting Svs

WILLIAM C STUCKEY
Coats North America

KIMBERLY A IVEY*
Clemson Univ

CHUNG SUN SUH
Suh & Assoc

CHRISTOPHER K LAM*†
Clemson Univ

MANFRED WENTZ
Textile Care Int'l (TCI) Ltd

RA109 Flammability Technology

Scope: To promote and encourage the investigation, study and discussion of problems associated with flammability characteristics of textile fabrics; to promote and coordinate technical programs of special interest to individuals and groups concerned with the application of flame retardants in dyeing or finishing; and to provide sources for increased technical knowledge for the benefit of individuals and groups concerned with flame resistance of textile fabrics.

Chair

RONALD R DOMBROWSKI
TechTex Solutions Inc

Secretary

To Be Designated

JESSICA ANN
Milliken & Co

SANDRA KOLBY
Bentley Prince Street

ALLYSON TENNEY*
US Consumer Product
Safety Comm

PETER G CHRISTIAN
Bloomsburg Mills

CATHERINE J MORIN
Morin Assoc

DONALD B THOMPSON
NC State Univ

THOMAS C COX
Amitech

MIR A QUDDUS
Whirlpool

BLAIR D TRASK
Omniflex

THOMAS FABIAN
Underwriters Labs Inc

WILLIAM A REARICK*
Cotton Inc

REMBERT J TRUESDALE
III
Southern Mills Inc

GREGORY D GEORGE
Innovative Chem Tech Inc

MEYER R ROSEN
Interactive Consulting Inc

PAMELA J JACO
Springs Ind

NAGAICHI SUGA
Suga Testing Instruments
Co Ltd

KAY M VILLA
Kay M Villa Consulting Inc

RAJINI JANARDHAN
Bureau Veritas CPS

Co Ltd

MICHELE L WALLACE
Cotton Inc

RA106 UV Protective Textiles Test Methods

Scope: To develop test methods for measurement of ultraviolet protective performance of fabrics and clothing. Test Method 183.

Chair

LEONARD T FARIAS '04
Cotton Inc

Secretary

NANCY E PEBENITO
Nike

NOUREDDINE ABIDI
Texas Tech Univ

PETER G CHRISTIAN*
Bloomsburg Mills

KANTI A JASANI
Guilford Mills Inc

JESSICA ANN*
Milliken & Co

PATRICIA C CREWS
Univ of Nebraska

ROBERT K LATTIE*
SDL Atlas LLC

MARTIN J BIDE
Univ of Rhode Island

THOMAS FABIAN
Underwriters Labs Inc

TAK MING MAN*
Bodycote Ortech Corp

PATRICK J BRENNAN
Q-Panel Lab Products

CAROL GRAHAM*
James H Heal & Co Ltd

JOHN L MORRIS*†
Technicare Servs Ltd

GEORGE L BRODMANN*
ROBERT V CASCIANI
Clariant Corp

KAY S GRISE
Florida State Univ

RODRIGO OLMEDO
Detertec SA

KEVIN G CHITTIM*†
Labsphere Inc

JAYANTI V ISHARANI
Ciba SP Chem Corp

MIR A QUDDUS
Whirlpool

ABDULHALIK ISKENDER*
Univ of Uludag

AJOY K SARKAR
Colorado State Univ

RAJINI JANARDHAN*
Bureau Veritas CPS

RICHARD S SIMONSON
Burlington Ind

* Nonvoting
† Nonmember AATCC

Reference Committees

RR1 Colorfastness to Acids and Alkalis Test Methods

Chair: To Be Designated
Test Method: 6

RR9 Ageing of Sulfur-Dyed Textiles Test Methods

Chair: THOMAS J BURNS
Clariant Corp
Test Method: 26

RR35 Damage by Retained Chlorine Test Methods

Chair: To Be Designated
Test Methods: 92, 114

RR45 Finish Analysis Test Methods

Chair: To Be Designated
Test Method: 94

RR52 Colorfastness to Perspiration Test Methods

Chair: NELSON E HOUSER
Test Method: 15

RR53 Colorfastness to Pleating Test Methods

Chair: CHRIS W SCHOUTEN
Test Method: 131

RR54 Colorfastness to Heat Test Methods

Chair: To Be Designated
Test Methods: 117, 133

RR68 Odor Determination Test Methods

Chair: To Be Designated
Test Method: 112

RR81 Flock Testing

Chair: To Be Designated
Test Method: 142

RR92 Interaction of Dyes and Finishes

Chair: JAYANT K SHAH
Consultant
Test Methods: 157, 163

RR97 Assessment of Barré Test Methods

Chair: DONALD B BARKER
NISH
Test Method: 178

RR98 Assessment of Dye Strength and Shade Test Methods

Chair: BOB L MCCONNELL
Test Method: 182

AATCC Representatives on Committees of Other Organizations

American National Standards Institute

USA Technical Advisory Group (TAG) for ISO*TC38—Textiles

Representative with voting power:

Robert K. Lattie
SDL Atlas L.L.C.

Alternates:

Amy G. Hammonds
AATCC

John Y. Daniels
AATCC

ISO/TC38 Subcommittee 1—Tests for Coloured Textiles and Colorants

Robert K. Lattie
SDL Atlas L.L.C.

SC1/Working Group 1—Light and Weathering

Robert K. Lattie
SDL Atlas L.L.C.

SC1/Working Group 2—Washing

Nodie M. Washington
Procter & Gamble Co.

SC1/Working Group 3—Atmospheric Contaminants

Luther M. Myers
Textile Innovators Corp.

SC1/Working Group 4—Heat Treatments

Robert K. Lattie
SDL Atlas L.L.C.

SC1/Working Group 5—Adjacent Fabrics

Luther M. Myers
Textile Innovators Corp.

SC1/Working Group 7—Colour Measurement

Roland L. Connelly Sr.
GretagMacbeth LLC

SC1/Working Group 8—Dry Cleaning

Charles L. Riggs
Texas Woman's Univ.

SC1/Working Group 11—Characterization of Dyestuffs

Frank A. Fuss
MeadWestvaco

SC1/Working Group 13—Miscellaneous Technical Projects

Adam R. Varley
Vartest International

ISO/TC38 Subcommittee 2—Cleansing, Finishing and Water Resistance Tests

Norma M. Keyes
Cotton Inc.

SC2/Working Group 1—Professional Cleaning

Charles L. Riggs
Texas Woman's Univ.

SC2/Working Group 2—Finishing

Robert K. Lattie
SDL Atlas L.L.C.

SC2/Working Group 3—Domestic Washing and Drying

Nodie M. Washington
Procter & Gamble Co.

SC2/Working Group 4—Appearance Retention

Karen E. Kylo
Intertek Testing Services

SC2/Working Group 6—Durability of Flame Retardant Finishes

Catherine J. Morin
Morin Associates

SC2/Working Group 8—Water Resistance Tests

Richard S. Simonson
Burlington Industries

SC2/Working Group 9—Industrial Washing & Finishing Procedures

Charles L. Riggs
Texas Woman's University

SC2/Working Group 10—Water Vapour Transfer Test Methods

Brian Farnsworth
W. L. Gore & Associates

SC2/Working Group 11—Miscellaneous Technical Projects

Adi B. Chehna
Textile Tech Services

ASTM

Joint AATCC-ASTM Committee on Textile Testing

Representatives with voting power:

Roland L. Connelly Sr.—GretagMacbeth
Amy G. Hammonds—AATCC
Norma M. Keyes—Cotton Inc.
Robert K. Lattie—SDL Atlas L.L.C.
Richard A. Malachowski—Cranston Print Works
Luther M. Myers—Textile Innovators Corp.
Richard S. Simonson—Burlington Industries
Nodie M. Washington
Procter & Gamble Co.

Inter-Society Color Council

Official delegates:

Rolf G. Kuehni, *Chair*—DyStar LP‡
David Hinks—North Carolina State University‡
Ann C. Laidlaw—GretagMacbeth‡

Chemical Heritage Foundation

AATCC Representative:

Herbert T. Pratt
Consultant

National Fire Protection Association

Manfred Wentz
Textile Care International Ltd.

*International Organization for Standardization
‡Voting delegates

Joint Report

C2 Executive Committee on Research

RICHARD A. MALACHOWSKI, Cranston Print Works Co., *Chair*

C3 Technical Committee on Research

RICHARD S. SIMONSON, Burlington Industries, *Chair*

The following report summarizes a few of the many activities that the technical portion of AATCC, through the guidance of the Executive Committee on Research and the Technical Committee on Research, was involved in during 2004. Listings below provide some detail of these activities carried forward by the network of test method and technology committees. More complete reports of committee activities can be found in the annual reports filed by individual committees beginning on page 459.

Revised Test Methods

- 8-2004, Colorfastness to Crocking: AATCC Crockmeter Method
- 16-2004, Colorfastness to Light
- 20-2004, Fiber Analysis: Qualitative
- 20A-2004, Fiber Analysis: Quantitative
- 96-2004, Dimensional Changes in Commercial Laundering of Woven and Knitted Fabrics except Wool
- 99-2004, Dimensional Changes of Woven or Knitted Wool Textiles: Relaxation, Consolidation and Felting
- 101-2004, Colorfastness to Bleaching with Hydrogen Peroxide
- 125-2004, Colorfastness to Perspiration and Light
- 132-2004, Colorfastness to Drycleaning
- 135-2004, Dimensional Changes of Fabrics after Home Laundering
- 179-2004, Skewness Change in Fabric and Garment Twist Resulting from Automatic Home Laundering
- 183-2004, Transmittance or Blocking of Erythemally Weighted Ultraviolet Radiation through Fabrics
- 187-2004, Dimensional Changes of Fabrics: Accelerated

Reaffirmed Test Methods

- 103-2004, Bacterial Alpha-Amylase Enzymes used in Desizing, Assay of
- 119-2004, Color Change Due to Flat Abrasion (Frosting): Screen Wire Method
- 178-2004, Barré: Visual Assessment and Grading
- 192-2004, Weather Resistance of Textiles: Sunshine-Arc Lamp Exposure With and Without Wetting

Reaffirmed and Editorially Revised Test Methods

- 23-2004, Colorfastness to Burnt Gas Fumes
- 24-2004, Insects, Resistance of Textile to
- 26-2004, Ageing of Sulfur-Dyed Textiles: Accelerated
- 27-2004, Wetting Agents: Evaluation of Rewetting Agents
- 28-2004, Insect Pest Deterrents on Textiles
- 30-2004, Antifungal Activity, Assessment on Textile Materials: Mildew and Rot Resistance of Textile Materials
- 43-2004, Wetting Agents for Mercerization
- 92-2004, Chlorine, Retained, Tensile Loss: Single Sample Method
- 93-2004, Abrasion Resistance of Fabrics: Accelerator Method
- 100-2004, Antibacterial Finishes on Textile Materials: Assessment of
- 104-2004, Colorfastness to Water Spotting
- 117-2004, Colorfastness to Heat: Dry (Excluding Pressing)
- 120-2004, Color Change Due to Flat Abrasion (Frosting): Emery Method
- 128-2004, Wrinkle Recovery of Fabrics: Appearance Method
- 131-2004, Colorfastness to Pleating: Steam Pleating
- 133-2004, Colorfastness to Heat: Hot Pressing
- 141-2004, Compatibility of Basic Dyes for Acrylic Fibers
- 147-2004, Antibacterial Activity Assessment of Textile Materials: Parallel Streak Method
- 181-2004, Colorfastness to Light at High Temperature: Daylight Temperature and Humidity Controlled Apparatus
- 191-2004, Acid Cellulase Enzymes, Effect of: Top Loading Washer

Editorially Revised

- 6-2001, Colorfastness to Acids and Alkalis
- 15-2002, Colorfastness to Perspiration

- 17-1999, Wetting Agents, Evaluation of
- 35-2000, Water Resistance: Rain Test
- 42-2000, Water Resistance: Impact Penetration Test
- 61-2003, Colorfastness to Laundering, Home and Commercial: Accelerated
- 76-2000, Electrical Surface Resistivity of Fabrics
- 82-2001, Fluidity of Dispersions of Cellulose from Bleached Cotton Cloth
- 86-2000, Electrical Resistance of Yarns
- 88B-2003, Smoothness of Seams in Fabrics after Repeated Home Laundering
- 88C-2003, Retention of Creases in Fabrics after Repeated Home Laundering
- 106-2002, Colorfastness to Water: Sea
- 107-2002, Colorfastness to Water
- 109-2002, Colorfastness to Ozone in the Atmosphere under Low Humidities
- 110-2000, Whiteness of Textiles
- 114-1999, Chlorine, Retained, Tensile Loss: Multiple Sample Method
- 116-2001, Colorfastness to Crocking: Rotary Vertical Crockmeter Method
- 118-2002, Oil Repellency: Hydrocarbon Resistance Test
- 123-2000, Carpet Soiling: Accelerated Soiling Method
- 124-2001, Appearance of Fabrics after Repeated Home Laundering
- 129-2001, Colorfastness to Ozone in the Atmosphere under High Humidities
- 130-2000, Soil Release: Oily Stain Release Method
- 131-2000, Colorfastness to Pleating: Steam Pleating
- 139-2000, Colorfastness to Light: Detection of Photochromism
- 140-2001, Dye and Pigment Migration in a Pad-Dry Process: Evaluation
- 142-2000, Appearance of Flocked Fabrics after Repeated Home Laundering and/or Coil-Op Drycleaning
- 143-2001, Appearance of Apparel and Other Textile End Products after Repeated Home Laundering
- 146-2001, Dispersibility of Disperse Dyes: Filter Test
- 150-2003, Dimensional Changes of Garments after Home Laundering
- 151-2003, Soil Redeposition: Launder-Ometer Method

154-2001, Thermal Fixation Properties of Disperse Dyes

157-2000, Colorfastness to Solvent Spotting: Perchloroethylene

159-1999, Transfer of Acid and Pre-metallized Acid Dyes on Nylon

161-2002, Chelating Agents: Disperse Dye Shade Change Caused by Metals; Control of

162-2002, Colorfastness to Water: Chlorinated Pool

164-2001, Colorfastness to Oxides of Nitrogen in the Atmosphere under High Humidities

165-1999, Colorfastness to Crocking: Textile Floor Covering—AATCC Crockmeter Method

170-2001, Dusting Propensity of Powder Dyes: Evaluation of

172-2003, Colorfastness to Non-Chlorine Bleach in Home Laundering

174-1998, Antimicrobial Activity Assessment of Carpets

176-2001, Speckiness of Colorant Dispersions: Evaluation of

188-2003, Colorfastness to Sodium Hypochlorite Bleach in Home Laundering

New Test Methods

193-2004, Aqueous Liquid Repellency: Water/Alcohol Solution

Withdrawn Test Methods

180-1997, Colorfastness to Light at High Temperatures: Daylight Temperature Controlled Apparatus

AATCC International Conference & Exhibition Technical Program

The 2004 AATCC International Conference & Exhibition was held at the Palmetto Expo Center in Greenville, SC September 13-16, 2004. The technical program was organized by the Executive Committee on Research. Harold Freeman, the Olney Medalist, presented the Olney Medal Address, "Color Yes, Toxicity No: Systematic Approaches to Meeting this Challenge."

The Herman and Myrtle Goldstein Student Paper Competition was moderated by Ian R. Hardin, University of Georgia, and consisted of the following presentations: The Biodegradation Pathway of Disperse Orange 3 by White Rot Fungus *Pleurotus ostreatus*, Wang Lu, University of Georgia; Measurement of the Color of Liquid, Powder and Loose Fiber Samples, Richard Payne, University of Leeds; An Assessment of the Technical Performance of Photochromic Dyes in Textile Printing, Julie Galbraith, Galashiels University of Textiles and Design.

The conference consisted of 11 technical sessions, five Concept 2 Consumer sessions and over 30 posters. Listed be-

low are the sessions with moderator, title of the presentations and speakers for the technical and C2C sessions:

Product Improvement and Innovation moderated by S. Jean Hoskin, May Merchandising Co; Get it Right the First Time, David Millar, Express; Workflow Management: A Critical Application in Today's Garment Development Process, Jerome Johnson, UGS PLM Solutions; Copyright Legalities - Trusting your Source, Barbara Kaplan, VF Corp.; and Adaptive Technology in a Changing World, Judson H. Early, [TC]².

Data Make a Difference moderated by John A. Darsey Jr., Color Solutions International; Direct Pattern Generation from 3D to 2D, Kimberly D. Munro, [TC]²; End to End Visibility from Product Concept to DC, Fred Isenberg, New Generation Computing Inc.; When the Color is Black, the Number is Zero, Michael J. Bradbury, Color Solutions International; and Information Management and Vendor Performance, Jeffery Jones, Bureau Veritas.

Color: Imagination, Energy, and Initiative moderated by Mary N. Brannon, VF Jeanswear; Standards for Color Communication, Roland L. Connelly Sr., Gretag-Macbeth LLC; Why We Need Lab Dips?, Charles O. Green, Galey & Lord Inc.; The Perfect Accessory, Susan Williams, Global Colour Solutions and DigiEye PLC; and Color Management Program Roundtable Discussion: Bill Sherrill, Archroma; David Simmonds, Ciba; John A. Darsey Jr.; Karen F. Gaskins, Datacolor; Richard Lawn, e-Warna; and session speakers.

Printing: Pushing the Gamut moderated by Dewey L. Todd, Springs Industries Inc.; Traditional vs. Digital Printing: What's the Difference?, Richard Malachowski, Cranston Print Works Co.; Digital Fabric Printing in Today's Commercial Marketplace, Danielle Locastro, First2Print; Integrated Global Print Management, Julie K. Crowder, Rothtec Corp.; and Textile Samples to Production: Digital Inkjet Printing Technology, Steve Liker, Trident-ITW.

Extra! Extra! Tools to Enhance Your Process moderated by Sandy Johnson, Ciba; Brand Integrity, Expectation vs. Execution, Randolph L. Finley, David's Bridal; Coloring the Retail Scene, Chris Sargeant, Colour True Colour Management Consultancy; The Cost of Color, Thomas E. Stutts, Datacolor; and Color Practice and Process Guidebook, Mary Ann Moore, Florida State University.

International Business moderated by Phillip L. Goodman, Boehme Filatex Inc.; An Update on NCTO and Global Trade Issues, James M. Chesnutt, National Spinning Co. Inc.; Global Trends in the Apparel Industry, Jeanette Sullivan, PricewaterhouseCoopers LLP; Ex-

porting in a Global Economy, John D. Mittelstaedt, Clemson University; and Who Is Our Customer? A Look at the Textile and Apparel Industries from Inside a Small Business, Charles W. Stewart, Tumbling Colors Inc.

Innovative Fibers and Technical Textiles moderated by Nelson E. Houser, M. Dohmen USA Inc.; Development of Melt Spun Acrylic Fiber: Characterization of Dyeing Properties, Lei Qian, Institute of Textile Technology; New Fiber and New Ways to Process Fabrics, William Whitehouse, Tencel Inc.; New Products for Specialty Markets, John Anderson, Wellman Inc.; Understanding Reactive Tending, David T. Karst, University of Nebraska-Lincoln; and Morphological Effects and Consequences of Developed Microstructure on the Optical and Electronic Properties of Conjugated Polymeric Fibers and Films for Applications in Smart Materials, Richard Gregory, Old Dominion University.

Flammability moderated by William A. Rearick, Cotton Incorporated; Current Status of Flammability Regulations in the U.S., Michele L. Wallace, Cotton Incorporated; Flame Retardant Finishing of the Cotton/Nylon Battle Dress Uniform Fabrics by a Hydroxyl-Functional Organophosphorus Oligomer in Combination with a Mixture of Trimethylol Melamine and DMDHEU, Charles Yang, University of Georgia; Influence of Fiber Quality on the Properties of Cotton Fabrics Treated with Flame Resistant and Easy Care Finishes, George F. Ruppenicker, U.S. Department of Agriculture, Southern Regional Research Center; and Cotton and Cotton Blended Batting Fire Blocking Barriers for Soft Furnishings to Meet Federal and State Flammability Standards, Stephen Wolf, Jones Fiber Products Inc.

Preparation moderated by Barry T. Byrd, BASF Corp.; Enzymatic Desizing: A Review of the Basics, James Trammel; Preparation of Elastomeric Fibers, C. Brent Smith, Rockland Industries; Chemical Applications: Past, Present, and Future, J. Preston Aldridge Jr., Ford, Trimble, and Associates Inc.; and Bleaching of Cotton with Activated Peroxide Systems, David Hinks, North Carolina State University.

Dyeing moderated by Teresa C. Madeleine, Invista Inc.; Explanation and Prediction of Disperse Dye Exhaustion on PLA, David T. Karst; Improvement of Bleaching Resistance of Sulfur Dyed Textiles, Yiqi Yang, University of Nebraska-Lincoln; Enzyme-Mediated Dyeing of Textile Fibers, Harold S. Freeman; and Synthesis and Application of Fiber-Reactive Dyes using Supercritical Carbon Dioxide, Nattaya Punrattanasin, North Carolina State University.

Color Science moderated by Rolf G.

Kuehni; Rapid Fiber Luster Measurements with a Portable Lustermeter, James E. Rodgers III, Solutia Inc.; Quantitative Measurement of Web Uniformity of Blended Fibers, James N. Reed, North Carolina State University; Objective Color Evaluation: A Better Solution for Color Quality Control of Textile Materials?, John Xin, Hong Kong Polytechnic University; Management of Color Standards in a Global Firm, Michelle Roberts, Adidas USA; and Visual Assessment of Staining: Observer Variability and Correlation with Instrumental Measurements using Different Formulas, Kashif Noor, North Carolina State University.

Medical Textiles moderated by Karen K. Leonas, University of Georgia; Textiles and Regenerative Medicine, Karen J. L. Burg, Clemson University; Durable and Rechargeable Biocidal Fabrics for Medical Applications, Gang Sun, University of California, Davis; Antimicrobial Activities of Textile Materials Treated with a New Chemical, Min Yao, ATEX Inc.; Comparison of Methods used to Predict Burn Injuries in TPP and RPP Tests, Guowen Song, North Carolina State University; and Antibacterial and Laundering Properties of AMS and PHMB as Finishing Agents for Healthcare Workers Uniforms, Jessica Chen-Yu, Virginia Tech.

Finishing Technologies moderated by Betty S. Tilley, Apollo Chemical Co.; High Performance Fabric, Dan Fouratt, Hi-Tex Inc.; New Functional Textiles by Finishing with Cyclodextrins, Jens Moldenhauer, Wacker-Chemie GmbH; Inkjet Printing of Conductive Patterns on Textile Fabrics, S. Mansour Bidoki, University of Leeds; and Plasma Applications in Textile Finishing, Lee F. Lemere, Consultant.

Environmental/Biotechnology moderated by Danny E. Akin, U.S. Department of Agriculture, Russell Research Center; Update on Textile Biotechnology in Europe, Shekhar Sharma, The Queen's University of Belfast; Textile Cellulases: Searching Molecules for Improved Performance, Anna-Liisa Auterinen, Genencor International; The Application of Capillary Electrophoresis-Mass Spectrometry (CE-MS) to Analysis of Biological Decolorization of Dyes, Ian R. Hardin; and A New Natural Cellulosic Fiber from Corn Stover: Potential and Characteristics, Narendra Reddy, University of Nebraska-Lincoln.

Education Programs

Listed are the topics, time, places and speakers for the four symposia, three workshops, and five certification programs held during 2004.

Innovations in Medical, Protective and Technical Textiles held February 18-19 in Raleigh, NC. Welcome and Opening Re-

marks were made by Peter J. Hauser, North Carolina State University and Symposium Chair. The New World of Textiles, Blanton Godfrey, North Carolina State University, began the program. Nelson E. Houser, Burlington Chemical Company moderated Session I, Innovative Fiber Technology, that included KoSa Fiber Innovations, Timothy St. Romain, KoSa; Positioning Bacteriostatic Products in the Medical Market, Dina Dunn, Nylstar; New Products for Specialty Markets, John Anderson, Wellman Inc.; and The Spinning of Silk-Like Protein Fibers, Sun-Won Ha, North Carolina State University. Kanti A. Jasani, Guilford Mills Inc. moderated Session II, Antimicrobials, that included Overview of Antimicrobials for Textiles, Jana S. Rajan, Avecia Biocides; Antimicrobial Functions for Synthetic Fibers – Recent Developments, Jeffrey F. Williams, Vanson HaloSource Inc.; Controlling Bacteria and Odors on Natural Fibers, John Payne, Avecia Protection and Hygiene; and Regulatory Requirements and Options for Antimicrobial Textiles, James C. Wright, Wright & Sielaty, P.C. Session III, Solar Protection, was moderated by Mike Stanhope, Southern Mills Inc., and included Stabilization of PET Fibers Against the Effects of Ultraviolet Light, John M. Zenner, CYTEC Industries Inc.; Apparel and Automotive Fabrics: Providing Solar Protection, Peter Haerri Ciba Specialty Chemicals Inc.; and Solar Ultraviolet Protective Clothing: What's Behind the Label?, Kathryn L. Hatch, University of Arizona. Session IV, Flame Retardants, moderated by Jana S. Rajan, included Flame Resistant Fibers, Mike Stanhope; Flame-Retardants and Barriers, Ronald Dombrowski, TechTex Solutions Inc.; and Flammability Regulations – What are the Burning Issues?, Michele L. Wallace, Cotton Incorporated. Session V, Medical Textiles, was moderated by Nelson E. Houser including Medical Textiles – Meeting User Needs, Marian G. McCord, North Carolina State University; and Effect of Mechanical Deformation on the Transport Properties of Barrier Materials, Juan P. Hinestroza, North Carolina State University. Session VI, Protection and Comfort, moderated by Kanti A. Jasani, included Moisture Management: Myths, Magic and Misconceptions, William A. Rearick, Cotton Incorporated; Assessing Moisture Vapor Transmissibility in USN Protective Garments, Jonathan W. Kaufman, Naval Air Systems Command; Optimizing Design with Phase Change Materials, Monte C. Magill, Outlast Technologies Inc.; and A New Test Instrument and Procedure for Evaluation of Fabrics Containing Phase Change Material, Douglas C. Hittle, Colorado State University. Peter J. Hauser moderated Session VII, New Applica-

tions, which included Morphological Effects and Consequences of Developed Microstructure on the Optical and Electronic Properties of Conjugated Polymeric Fibers and Films for Applications in Smart Materials, Richard V. Gregory, Old Dominion University; DNA Markers for Textiles – A Technology for Protecting Brands and for Use in Supply Chain Management, Don A. Alexander, Anovotek LLC; and Flame Resistant Barriers for Home Furnishings, Alan C. Handermann, Basofil Fibers LLC.

Color Communication: Practically Speaking was held March 9-10 at North Carolina State University in Raleigh, NC. Welcome and Opening Remarks were made by Roland L. Connelly, Sr., Gretag-Macbeth LLC, AATCC President, and David Hinks, North Carolina State University, Symposium Chair. Vision and Color, Joy T. Luke, Studio 231, lead off the symposium. Color Communication: The Foundation was moderated by David Hinks, and contained the following: The Multifaceted and Never Ending Trilogy of Making Color Communications Work, Seth L. Hanson, Capital Mercury Apparel Ltd.; Visual Color Difference Evaluation: Mind the Conditions, Rolf G. Kuehni; How to Establish a Color Control Program that Really Works, Nick Lena, GretagMacbeth LLC; How to Obtain and Interpret Colorimetric Data, J. Richard Aspland, Clemson University; and Visual Color Assessment, Amy G. Hammonds, AATCC. Color: Selection and Creation was moderated by Ken Butts, Datacolor, and consisted of the following: Color Standards – Development and Global Distribution, Michelle Roberts, Adidas; Color Inconstancy: What does it Really Mean?, Ronnier Luo, University of Leeds; and Environmental Aspects of Dye Applications, Brent Smith, North Carolina State University. Color Communication: The Real World was moderated by Ann C. Laidlaw, GretagMacbeth LLC, and included the following: Color Approval Process – As a Function of Successful Partnerships, Charles F. Bino, Target Corp.; Practical Instrumental Shade Sorting Techniques, Charles T. Witt, Carlisle Finishing Div., Cone Mills Corp.; Pushing Past Concepts: Trends and Successes in Color Management, Ken Butts; and Global Color Communication and Control, Clement Lam, Pacific Textiles. Color Control: Unsolved Mysteries was moderated by Carol T. Revels, Gap Inc., and included the following: Break Out Summaries; Do Dyeing Systems Matter? Yes!, Ed Turner, Cotton Incorporated; Towards an Improved Color Difference Formula, David Hinks; Controlling Lighting to Optimize Color Perception: Product Development to Point of Sale, Kashif Noor, North Carolina State University; and Measuring Optically

Brightened Textiles – A Better Method, Roland L. Connelly, Sr.

AATCC Concept 2 Consumer Symposium - Supply Chain Management: Just in Time Design was held March 10-11, also at North Carolina State University. Welcome and Opening Remarks were made by John A. Darsey, Jr., Color Solutions International, Symposium Chair, and Jack Y Daniels, AATCC Executive Director. Mr. Darsey moderated the Standard which included the following: The Textile Marketing Chain Vision 2010, Michael J. Bradbury, Color Solutions International; Speed to Market with Integrated Enterprise Systems, Fred Isenberg, New Generation Computing Inc.; A Detailed Manufacturer's Guide to Successful Retail Product Development and On-Time Delivery – From a Retailers' Perspective, Mandi Strickland, Belk Stores Services; Getting the Product You Want: Solutions for Communicating through the Supply Chain, Jordan K. Speer, *Apparel Magazine*; Supply Chain Game Introduction, Kristin Thoney and Jeffrey A. Joines, North Carolina State University; and Supply Chain Game and Break Out Sessions. S. Jean Hoskin, May Merchandising Co., moderated Supply Chain Management which included: Focus on Foundation Building, Rick Howard, Toyota Motor Manufacturing North America Inc.; Zen and the Art of Sourcing Home Fashion Products Overseas, Katy Chapman, CHF Industries; Speeding Up Color Approval Processes, K. C. Lau, Datacolor Asia Pacific (H.K.) Ltd.; Supply Chain Game and Break Out Sessions; Information Exchange, Becky Leu and Cheryl Hilton, Sears Roebuck & Co.; and Full Package Sourcing – Do the Colors Match?, Rolanda Morgan, Associated Merchandising Corp. Mary N. Brannon, VF Jeanswear, moderated the final session which included the following: Recap of Supply Chain Game, Kristin Thoney and Jeffrey A. Joines; Integrated Color and Supply Chain Management, Doug Bynum, Archroma Global Services/Clariant Ltd. and Julie Crowder, Rothtec; Testing Along the Supply Chain, Ronald J. Pacheco, Specialized Technology Resources Inc.; U.S. Customs and Border Protection Textile Issues, Janet L. Labuda, U.S. Customs and Border Protection; Bringing the Pieces Together: Solutions for the Apparel Industry, John J. Wilkins, FedEx Services; and C-TPA, Carlos Zavala, Williamson-Dickie Mfg. Co.

Color Measurement Principles and the Textile Industry Workshop was held October 12-13 at the AATCC Technical Center. The topics and speakers were Color and Appearance Technology, Ann C. Laidlaw, GretagMacbeth LLC; Instrumentation for Color Measurement, Ken Butts, Datacolor; Spectrophotometric

Transmittance Measurement of Dyestuffs in Solution, Donna D. Faber, Blackman Uhler Chemical Co.; The Many Shades of White, Ann C. Laidlaw; Dyestuff Strength Determination, Donna D. Faber; Color Difference, Robert F. Willis, GretagMacbeth LLC; Shade Sorting, Robert F. Willis; and Color Communication, John A. Darsey, Jr., Color Solutions International.

Digital Textile Printing Conference was held October 26-28 at [TC]² Corporate Headquarters in Cary, NC and was jointly produced by AATCC and [TC]². Welcoming remarks were made by Mike Fralix, [TC]², who also presented Exploring the Digital Supply Chain. The Technology and Market Overview session included Development, Segmentation & Global Market Forecast, Michael Flippin, Web Consulting Ltd.; and Technology Update – Jud Early and Kerry King, [TC]². Technology Challenges and Innovation Fabric Preparation and Ink Chemistry included Digital Fabric Printing: From Pre-Treatment to Post Processing, Steven Greaves, DigiFab Systems Inc.; Which Ink Do I Use?– David Clark, CIBA Specialty Chemicals; Digital Printing on Cotton, Mary Ankeny, Cotton Incorporated; Digital Sublimation: Defined, Chris Bernat, Sawgrass Technologies; Digital Textile Printing in Korea Technology Challenges, Sujin Moon, Yuhan-Kimberly; The Evolution of Textile Pigment Ink Jet Inks, John Provost, BASF Aktiengesellschaft; Hardware Solutions; Digital Textile Printing Solutions, Regianni-Marco Nespeca, Regianni Machine; DuPont Artistri System, Mike Compton, DuPont Inkjet; Production Printing in the Home Market, Richard Codos, Leggett & Platt; and Keeping your Finger on the Pulse of Innovations in Digital Textile Printing, Marc Van Parys, Technical University Gent-Belgium. A demonstration of Mass Customization was also presented. Managing Color and Print Results included Integrated CAD-CAM and Digital Printing Technologies, Jerry McCaskill, Ned Graphics; and Color Profiling Options for InkJet Printing – 'It's Not an Option!', Steve Smith, DPInnovations Inc. Digital Product Development and Production included Challenges & Opportunities when using Digital Printing for Sampling & Small-Scale Production, Andy Graven, Zenith Engraving; Service Provider Perspective (Cheran Digital Imaging); What U See is What U Get, Jorg van der Meij, Stork Digital Imaging BV; New Production Model for Profit and Control, Bill Grier, BetaColor; The Digikids Experiment: Incorporating Digital Textile Printing into Mass Customization of Apparel Products, J. R. Campbell, Iowa State University; Digital Product Design with Digital Inkjet Fabric Printing, Hitoshi Ujiie,

Philadelphia University; and The Business Case: The InkDrop Boutique Experiment, Richard Atwell, [TC]².

Introduction to Textile Testing Workshops were held on June 10-11 and December 1-2 at the AATCC Technical Center laboratories. Test methods and evaluation procedures were reviewed and other presentations made by AATCC staff members John Y. Daniels, Derrick Glass, Suzanne Greer, Amy G. Hammonds, Peggy J. Pickett and Julie Wetsch.

The AATCC Textile Technician Certification Program continued in 2004. North Carolina State University College of Textiles conducted Modules 1 & 2 on May 18-20 and December 7-9 and conducted Module 3 on June 29-30 and October 19-20. The instructors were NCSU staff members Jan E. Pegram, Leon S. Moser, Jeffery Krauss and Teresa White. The University of Rhode Island conducted Modules 1 & 2 on June 15-17. The instructor was URI professor Martin J. Bide. The certification program offers certification on Evaluation Procedures 1, 2 and 8 within Module 1, Test Methods 8 and 61 within Module 2, and Test methods 88B, 88C, 124 and 135 within Module 3.

Certificates of Service

At the May 5 meeting of the Technical Committee on Research, Richard S. Simonson, TCR chair, presented *Certificates of Service* to retiring members of the Executive Committee on Research and retiring chairs of research committees: Joseph J. Nilsen, chair, RA75 on Correlation of Laboratory Tests with End Use Performance; F. Powell Andrews III, chair, RA104 on Garment Wet Processing Technology; Brooks G. Tippett, chair, RA80 on Printing Technology; Mr. Simonson, chair, RA106 on UV Protective Textiles; Sandra Kolby, chair, RA57 on Floor Covering; Gilbert Ellerbe, chair, RA107 on Elastic Fabric Technology; Charles J. Kim, chair, RA89 on Hand Evaluation; Tamara Padron, chair, RA88 on Home Laundering Technology; Donald Thompson, chair, RA75 on Correlation of Laboratory Tests with End Use Performance; Jayson Vassallo, chair, RA73 on Warp Size Technology; Timothy A. Little, member, Executive Committee on Research; Barbara M. Gatewood, member, Executive Committee on Research; R. Michael Tyndall, chair, Executive Committee on Research, and Richard A. Malachowski, chair, Technical Committee on Research.

Acknowledgments

The technical activities of the Association are far reaching evidenced by the

many activities chronicled above and also included in the Reports of Research Committees. Its influence is felt world wide through the many test methods that have been adopted by international bodies to the participation by individuals from many different countries in the International Conference & Exhibition as well as the workshops and symposia. Many hours of dedicated service are

spent developing, modifying or refining test methods keeping them up-to-date. Technology committee members, speakers, moderators and steering committee members provide their time and knowledge in keeping industry personnel informed of changes and new developments. A constant flow of information is provided through the International Conference & Exhibition Technical Program

and the numerous workshops and symposia. The support of all these volunteers, their employers and corporate members is hereby acknowledged. The AATCC staff members who represent the constant stabilizing force that provide the logistics for keeping these many activities ongoing and who help bring this effort to fruition through publications such as this TECHNICAL MANUAL are also acknowledged.

Reports of Research Committees

RA32, Static Electricity

Chair: Stephen Fowler
Fowler Associates

Again, the committee has attempted a revision to the static decay tests of Federal Test Method 191, Method 5931, as a possible new test method for AATCC. A lack of volunteers and interest in the test methods caused this committee's work to stagnate. No meeting was held in November 2004.

RA-34, Preparation

Acting Chair: Kenneth Greeson
Cotton Incorporated

Two of three labs have completed the interlaboratory study using the proposed revision of Test Method 97, Extractable Content of Greige and/or Prepared Textiles. When the results are received from the third lab, statistical analysis of the data will be conducted in order to generate a precision and bias statement for this method.

An interlaboratory study was completed to establish a precision statement for Test Method 82, Fluidity of Dispersions of Cellulose from Bleached Cotton Cloth. Richard Barnhardt, subcommittee chair, is handling the data analysis.

Dr. Sang-Hoon Lim of North Carolina State University gave a talk on Bleach Activators at the May 2004 meeting. This talk was well received.

RA38, Colorfastness to Crocking

Chair: Richard Slomko
Atlas Weathering Services Group

RA38 continues to work on a procedure to qualify alternative testing instruments for Test Method 8, Colorfastness to Crocking: AATCC Crockmeter Method. SDL Atlas, Testfabrics and Gildan Activewear have offered to supply fabrics for this procedure. AATCC will evaluate the fabrics for this new procedure.

Test Methods 8 and 116, Colorfastness to Crocking: Rotary Vertical Crockmeter Method, were both revised in 2004. A new Wet Crocking preparation was added to both methods. Also, a committee ballot was passed to add an automated electronic grading system to both methods. This amendment will now be sent to TCR for approval.

A new blue calibration cloth has been developed that has a dry crock rating of 3-3.5. The committee discussed adding this new cloth to Test Method 8. More in-

formation will be gathered about this cloth and distributed to the committee.

RA42, Dimensional Change

Chair: Angela Massengill
Cotton Incorporated

Test Methods 96, Dimensional Changes in Commercial Laundering of Woven and Knitted Fabrics except Wool, and 99, Dimensional Changes of Woven or Knitted Wool Textiles: Relaxation, Consolidation and Felting, are up for reaffirmation. Test Method 96 is being balloted for reaffirmation and Test Method 99 is being advertised for possible withdrawal.

A subcommittee is working on establishing precision and bias statements for Test Methods 135, 150, and 179 as well as evaluating the use of AATCC Liquid Detergent in each method. A variety of fabrics are being screened at AATCC to decide which fabrics should be used in the interlab study. Interlab participants include, SGS, SDL Atlas, National Textiles, Intertek, and Cotton Incorporated.

Several topics were discussed and are being reviewed by the committee for consideration as research topics for the AATCC foundation.

RA49, Insect Resistance

Chair: Laval Yau
Thomson Research Associates

At the beginning of 2004 there were only two issues left to be resolved with the two proposed dust mite test methods, "*Assessment of the Anti-House Dust Mite Properties of Textiles Under Semi-Natural Conditions*" and "*Acute or Short-term Assessment of the Anti-House Dust Mite Properties of Textiles*." These were the retention of the mites on the test fabric during the short-term test and the recovery of mites in both methods.

A proposal by Canesis of New Zealand to sort out these two issues was accepted and results were available for the November meeting. As a result of this effort, the two proposed methods have been re-drafted and a second round-robin will take place in 2005.

The committee discussed a proposal from Mahidol University in Bangkok, Thailand to develop specific criteria and eventually a test method to ascertain whether anti-mite bedding encasement products are indeed impermeable to mites. Currently there are no guidelines or existing protocols.

It was decided to advertise for possible

withdrawal of Test Method 24, Insects, Resistance of Textiles to, due to lack of use and need.

RA56, Stain Resistance

Chair: Bill Kimbrell
Milliken & Co.

Justine Franchina, of DuPont, was elected Secretary of RA56.

Status of test method development at the end of 2004 was as follows:

The "Aqueous Liquid Repellency: Water/Alcohol Resistance Test" was approved and will be published in the 2005 AATCC TECHNICAL MANUAL.

The proposed "Stain Management Performance Method" was submitted for committee ballot. The subcommittee continues to work on this method and resolve negative votes from the ballot. The entire committee devoted significant time to discussing this proposed method during both the May and November meetings. This proposed method attempts to address both the resistance to staining with common consumer stains and the release of residual stains during laundering. Many of the issues that this proposed method attempts to address will be examined by the Method 130 subcommittee which is working on a revision of Method 130 during 2005. Both subcommittees will report during the May 2005 committee meeting.

A proposed new test method, "Stain Release: Spot Removal of Oily Stain Method," was presented during the November meeting. This method will address the removal of stains on fabrics that are not laundered, such as automotive upholstery fabrics. A subcommittee was established to refine and evaluate this proposed method.

Finally, the committee is evaluating the performance of the new AATCC Liquid Detergent for test methods under RA56. The Test Method 130 subcommittee is responsible for this evaluation.

RA60, Colorfastness to Washing

Chair: Liz Eggert
Procter & Gamble Co.

It was reported by the committee that the tests described in Test Method 61, Colorfastness to Laundering, Home and Commercial: Accelerated, do not resemble current commercial practices. A committee ballot to remove commercial references has been passed. The method will proceed to TCR balloting.

The committee is in the process of incorporating the 2003 AATCC Liquid Detergent into its test methods with initial testing being performed on Test Method 61. The committee will continue incorporation of the liquid detergent into all of its tests methods next year.

The accelerated Hand Wash method is in its final stages of development and will be sent to participating labs in 2005 to confirm repeatability. Work to incorporate it into the AATCC TECHNICAL MANUAL is expected to be completed by end of 2005.

RA61, Appearance Retention

Chair: Jamie Moak
Procter & Gamble Co.

Work to update methods continues. Several methods (including Test Method 143) have materials listed in the equipment section of the method whose use is not specified in the text. Amended methods with the appropriate use of the equipment will be balloted this year.

An interlaboratory study has begun to confirm that the use of the AATCC Standard Liquid Detergent is appropriate in the RA61 test methods. Garments will be purchased and tested in both the liquid detergent and the 1993 AATCC Standard Powder Detergent WOB. Data has already been generated and approved for Test Method 124 and wording around the use of the Standard Liquid Detergent will be balloted.

A subcommittee has been formed to evaluate a new viewing board that GTI Graphic Technology, Inc. presented to the committee. The subcommittee will work with GTI Graphic Technology Inc. to ensure that the results obtained when using the new viewing board are consistent with those obtained with traditional viewing boards.

The committee continues to need statistical support for developing precision and bias statements from existing interlaboratory data.

RA88, Home Laundering Technology

Chair: Nodie M. Washington
Procter & Gamble Co.

The committee continues to work on a protocol which will allow assessment of washing machines suitable for use with AATCC test methods. Led by Nick Agrawal, this subcommittee has developed a fabric set which will allow guidelines to be developed related to shrinkage, abrasion and colorfastness. Interlaboratory testing will occur in 2005. Machine parameters used by participating laboratories will be determined by SDL Atlas to allow correlation of performance with machine specifications.

Several monographs are progressing through committee and TCR ballots: 1) Detergent Use in Laboratory Testing. This monograph emphasizes the importance of using standard reference detergents in AATCC testing. 2) Revision of Standardization of Home Laundry Test Conditions. The revision provides perspective on machine specifications outside the U.S. and measurement of drying temperature. 3) Standard Laboratory Practice for Hand Laundering of Fabrics & Apparel. This is a new monograph addressing the need for a standard hand laundering protocol.

Key presentations during 2004 have increased awareness on RA88's need to broaden its project portfolio to include energy efficient/low-water washing machines, lower wash temperatures, inclusion of fabric softener test protocols and the need to work with detergent (ASTM D12) and appliance (AHAM) industry groups to assure method alignment. These will serve as potential work areas in 2005.

RA105, Supercritical Fluid

Chair: Michael J. Drews
Clemson University

At the May 2004 meeting, Dr. Drews presented an excellent talk on "Use of Supercritical CO₂ Fluids for the Sterilization of Biomaterials." In this presentation he

shared some of the drawbacks of the current sterilization methods, listed characteristics of an ideal sterilization method, stated that the goal of the research was to develop a one-step cleaning and sterilization process using temperature, pressure, time and solvents/additives without adversely affecting properties of the sensitive biomaterials, and shared results with water, H₂O₂, ethanol and isopropanol. He concluded that supercritical CO₂ can kill all three standard bacterial spores; H₂O₂ is the most effective additive and higher pressure and temperature are better than lower temperature and pressure for sterilization.

Dr. Drews then gave a brief history of RA105. RA105 started as a technology committee and then very shortly became a test method committee with the goal of developing a supercritical CO₂ extraction method to replace solvent extractions. Interest in analytical supercritical fluid extraction has diminished to the point that there is now only one manufacturer of lab-scale extractors. After discussion, it was recommended that RA105 investigate moving their activities into Committee RA100, Safety, Health and Environmental Technology, to provide periodic updates on the use of supercritical CO₂ in textile related applications.

RA105 did not meet in November 2004 and no speakers or topics for a future meeting were identified.

RA 109, Flammability Technology

Chair: Ronald Dombrowski
TechTex Solutions, Inc.

In keeping with the purpose of the committee to inform and educate it members on flame retardants and burn test methods, a presentation was made at the May meeting. The purpose of the presentation was to give an objective review of brominated flame retardants.

The November meeting brought about agreement to hold a flammability symposium in early 2006 dealing with test methods and related equipment.

Corporate Members

Note: The following listing of corporate members includes the corporate designee for each organization. Dates show when the organization became a corporate member.

3M Co, 3M Center Bldg 236-2C-13, Saint Paul MN 55144-0001, w-(651) 736-5628, f-(651) 736-5793, Paul L Johnson, Tech Specialist (1958)

Advanced Testing Instruments, PO Box 338, Reidsville SC 29375-0338, w-(864) 989-0566, f-(864) 989-0567, Tim Ziegenfus, Pres (2000)

AI Research Co, PO Box 9114, Mansfield MA 02048-9114, w-(508) 339-7300, f-(508) 339-4996, Marcia Quinlan, Prog Mgr (1992)

Alabama Textile Mfrs Assn, 401 Adams Ave Ste 710, Montgomery AL 36104-4326, w-(334) 279-1250, f-(334) 279-1225, David H Seagraves, Exec Vice Pres (1999)

Alco Chemical Co, 909 Mueller Ave, Chattanooga TN 37406-1334, w-(423) 961-2487, f-(423) 698-8723, Win C Cooke, Div VP (1974)

Allied Industrial Corp Ltd, 12F #76 Sec 2 Tun Hwa S Road, Taipei 106 61 TAIWAN, w-27030209, f-27030289, James Wei, Vice Pres (1983)

Amar Impex, 14/16 MMGS Marg 3rd Fl, Amar House Dadar E, Mumbai 400 014 INDIA, w-01191224105805, f-01191224105808, Dhaval Visaria, Partner (2003)

American & Efird Inc, PO Box 507, Mount Holly NC 28120-0507, w-(704) 822-6014, f-(704) 827-4782, Steve Patrick, Plant Mgr (1966)

Americos Industries Inc, B-610/611 Ganesh Plaza, Near Navrangpura Post Office, Ahmedabad Gujarat 380 009 INDIA, w-011917926447782, f-011917926447736, Ashok Khanna, Managing Dir (2005)

Apex Chemical Corp, PO Box 1000, Una SC 29378-1000, w-(864) 578-0030, f-(864) 578-0107, Emil Baer, Pres (1944)

Apollo Chemical Corp, PO Box 2176, Burlington NC 27216-2176, w-(336) 226-1161, f-(336) 228-6963, Jimm Barbery, Vice Pres of Sales and Mkg (1975)

AppTec, 1265 Kennestone Cir Ste B, Marietta GA 30066-6037, w-(770) 514-0262, f-(771) 514-0294, Karen Alexander, Dir of Microbial Assays (2005)

Arch Chemicals Inc, 5890 Sequoia Ln, Douglasville GA 30135-5573, Thomas E Robitaille, Project Leader (2004)

Associacao Brasileira De Quimicos & Colorists Textels, Praca Flor De Linho 44, Centro Commercial De Alphaville, 06453 000 Barueri Sao Paulo, BRAZIL, w-011551141954931, f-011551141919774, Jose Clarindo De Macedo, Vice Pres (2002)

Atlas Material Testing Tech LLC, 4114 N Ravenswood Ave, Chicago IL 60613-1786, w-(773) 327-4520, f-(773) 327-5787, Russell W Lane, Pres (1944)

BASF Corp, 4330 Chesapeake Dr, Charlotte NC 28216-3411, w-(704) 398-4344, f-(704) 394-8336, Fransis Chadikun (1957)

Boehme Filatex Inc, 209 Watlington Industrial Dr, Reidsville NC 27320-8147, w-(336) 342-6631, f-(336) 634-3324, Phillip L Goodman, Pres/COO (1982)

Bolger & O'Hearn Inc, PO Box 250, Fall River MA 02724-0250, w-(508) 676-1518, f-(508) 677-9220, Shaun O'Hearn Jr (1998)

Bozzetto Inc, 2507 S Elm Eugene St, Greensboro NC 27406-3620, w-(336) 333-7556, f-(336) 333-7964, Gregg Jones, Pres (1965)

Bradford Dyeing Assn Inc, PO Box 539, Westerly RI 02891-0539, w-(401) 377-2231, f-(401) 377-2234, Michael Grills, Pres (1955)

Buckeye Fabric Finishing Co, PO Box 216, Coshocton OH 43812-0216, w-(740) 622-3251, f-(740) 622-9317, Kevin E Lee, Pres (2004)

Bureau Veritas Consumer Prod Service, 100 Northpointe Pkwy, Buffalo NY 14228-1884, w-(716) 505-3592, f-(716) 505-3301, Sandeep Khatua (1994)

Burlington Industries, 804 Green Valley Rd Ste 300, Greensboro NC 27408-7039, w-(910) 379-4533, f-(910) 379-4504, Dale Arnold, VP Product Dev (1945)

Cargear Industrial Limited, Unit 12 - 23/ F Wah Fat Ind Bldg, 10-14 Kung Yip St - Kwai Chung, Hong Kong CHINA, w-01185224893366, f-01185224262797, Leung Chi Chung Danny, Sales Dir (2005)

Carpet & Rug Institute, PO Box 2048, Dalton GA 30722-2048, w-(706) 278-3176, f-(706) 228-8835, E Kenneth McIntosh, Tech Dir (1974)

Cekal Specialties Inc, PO Box 788, Mount Holly NC 28120-0788, w-(704) 822-6206, f-(704) 822-6641, Dallas D Crotts, Vice Pres (2004)

Cellusuede Products Inc, PO Box 716, Rockford IL 61105-0716, w-(815) 964-8619, f-(815) 964-7949, John A Maxson III, Tech Dir (1952)

Chem-Tex Laboratories Inc, PO Box 5228, Concord NC 28027-1503, w-(704) 392-9322, Michael H Smith, Pres (1987)

CHT R Beitlich Corp, PO Box 240497, Charlotte NC 28224-0497, w-(704) 529-1274, f-(704) 522-8142, Wendy McBryde, Admin Office Mgr (1984)

Ciba Specialty Chemicals, 4050 Premier Dr, High Point NC 27265-8142, w-(910) 801-2695, f-(336) 801-2808, Kent Kvaal, Pres (1923)

Clariant Corp, 4331 Chesapeake Dr, Charlotte NC 28216-3410, w-(704) 331-7057, f-(704) 391-2787, John Schofield, Vice Pres Textile Dyes (1935)

Classic Dyestuffs Inc, PO Box 2368, High Point NC 27261-2368, w-(910) 841-2346, David W Picha, Pres (1980)

Cognis Corp, PO Box 411729, Charlotte NC 28241-1729, w-(704) 945-8874, f-(704) 945-8804, Jeffrey T Langley, Dir of R&D (1944)

Color Solutions International, 8318 Sardiscroft Rd, Charlotte NC 28270-0935, w-(704) 845-8000, f-(704) 845-8015, John A Darsey Jr, CEO (2001)

Color/BetaColor, 4385 E Lowell St Ste A, Ontario CA 91761-2228, w-(919) 390-4393, f-(919) 390-4843, William Grier, Pres (2005)

Consos Inc, PO Box 34186, Charlotte NC 28234-4186, w-(704) 596-2813, f-(704) 596-4861, Beth Herlocker (1978)

Cotton Incorporated, 6399 Weston Pkwy, Cary NC 27513-2314, w-(919) 678-2220, f-(919) 678-2235, Bobby Gordon, Dir Dyeing (1975)

Cranston Print Works Co, 2 Worcester Road, Webster MA 01570, w-(508) 943-0520, Richard Malachowski, Dir Research (1943)

CT Nassau Corporation, PO Box 39, 4101 S NC Hwy 62, Alamance NC 27201-0039, w-(336) 570-0091, f-(336) 570-1519, Carl Carpenter, VP of Production (2003)

Daikin America Inc, 402 Willow Spring Ct, Greensboro NC 27410-3118, David Costner, Accounts Mgr (1998)

Dan River Inc, PO Box 261, Danville VA 24543-0261, w-(434) 799-4874, f-(434) 799-4834, E Linwood Wright, VP Quality Serv & Dev (1945)

Datacolor, 5 Princess Rd, Lawrenceville NJ 08648-2301, w-(609) 924-2189, f-(609) 895-7472, Liz Walker, Dir Worldwide Mktg Comm (1982)

DEVREKHA Exports, A2 6/102, GIDC Sachin Dist Surat, Gujarat 394 230 INDIA, w-0112612372470, f-0112612372805, Devendra S Naik, CEO (2004)

Dexter Chemical LLC, 845 Edgewater Rd, Bronx NY 10474-4901, w-(718) 542-7700, f-(718) 991-7684, Leonard Sitver (1950)

Digifab Systems Inc, 110 E 9th St, B-209, Los Angeles CA 90079-1300, w-(213) 689-3400, f-(213) 689-3401, Avedik Izmirlian, Pres (2002)

Disney Worldwide Services, Costume Division, PO Box 10000, Orlando FL 32830-1000, w-(407) 560-5525, f-(407) 560-3631, Jeff Krisch, Mgr Costume Purchasing (1999)

Dooley Chemical LLC, PO Box 71951, Chattanooga TN 37407-0951, w-(423) 624-0086, f-(423) 622-4848, Rick Wilson, Pres (1968)

Dow Corning Corp, PO Box 994, Midland MI 48686-0001, w-(989) 496-6000, f-(989) 496-6974, Cindy A Esler, Mktng (1963)

Duratec Inc, 6998 Highway 1, Boyce LA 71409-9297, w-(318) 619-1160, f-(318) 619-1180, E Roger Wilson, Pres (2004)

Dycho Co Inc, PO Box 513, Niota TN 37826-0513, w-(423) 568-2112, f-(423) 568-2116, Tracey B Simpson, Pres (1995)

Dysin-Chem Limited, Skylark Point 3rd Fl 24/A Bijoy Nagar, Shohid Syed Nazrul Islam Soroni, Dhaka 1000 BANGLADESH, w-01188028316729, f-01188029348682, Md Mizanur Rahman, Managing Dir & CEO (2001)

DyStar LP, 9844-A Southern Pine Blvd, Pine Brook III, Charlotte NC 28273-5561, w-(704) 561-3000, f-(704) 561-3005, Mike Jordan, Lab Supervisor (1947)

E J Snyder & Co, PO Box 670, Albemarle NC 28002-0670, w-(704) 982-9105, Edward J Snyder Jr, Pres (1968)

Eastern Color & Chemical Co, PO Box 6161, Providence RI 02940-6161, w-(401) 331-9000, f-(401) 331-2155, Barry S Shepard, Pres (1961)

Elastomeric Textiles Ltd, Unit B 4/ F Winner Bldg, 36 Man Yue St Hung Hom, Kowloon HONG KONG, w 0118522369396 x115, f-01185227641337, Ignatius T H Chan (2005)

Everlight USA Inc, 10507 Southern Loop Blvd, Pineville NC 28134-7383, w-(704) 588-1004, f-(704) 588-0051, Scott Chen, Pres (2002)

EWarna, B-15-8 Megan Avenue II, 12 Jalan Yap Kwan Seng, 50450 Kuala Lumpur MALAYSIA, w-0160321618333, f-0160321622993, Shiew ManHon, CEO (2002)

Fred Whitaker Co, PO Box 12886, Roanoke VA 24029-2886, w-(540) 427-4343, f-(540) 427-3052, Fred Whitaker Jr, Plant Mgr (1953)

Genencor International Inc, 394 Greenhill Rd, Mocksville NC 27028-4202, w-(336) 492-6120, f-(336) 492-6120, Wade H Dyson Jr, Tech Sales Mgr (1982)

Glo-Tex International Inc, 25 Stan Perkins Rd, Spartanburg SC 29307-4336, w-(864) 579-9897, f-(864) 579-8679, Lawrence O Goldstein, Pres (1970)

Global Colors Inc, 1455 President St, Glendale Heights IL 60139-3602, w-(630) 462-6091, f-(630) 462-6092, Sayeeda Shameem, Vice Pres (2004)

Graphic Arts Technical Foundation, 200 Deer Run Rd, Sewickley PA 15143-2324, w-(412) 741-6860, f-(412) 741-2311, Richard D Warner, Vice Pres Research (1998)

Greenwood Products Inc, 255 Quaker Ln Ste 200, West Warwick RI 02893-7620, w-(401) 826-3333, f-(401) 826-3350, Sanjay Pande (2004)

GretagMacbeth LLC, 617 Little Britain Rd, New Windsor NY 12553-6150, w-(845) 565-7660, f-(845) 565-0390, Mariann Durso, Mktng Asst (2000)

GTI Graphic Technology Inc, 211 Dupont Ave, Newburgh NY 12550-4019, w-(845) 562-7066, f-(845) 562-2543, Robert McCurdy, VP Sales & Mktng (2004)

Guilford Mills Inc, 1754 NC 903 Hwy 11N, Kenansville NC 28349, w-(910) 296-5342, f-(910) 296-6344, Bernard K Flynn Sr, Tech Dir (1984)

Honeywell Nylon, 475 Reed Rd NW, Dalton GA 30720-6307, w-(706) 259-1442, f-(706) 271-2002, Michael S Suiter, Group Leader Test & Cert (1974)

Hosiery Technology Center, Catawba Valley Community College, 2030 Startown Rd, Hickory NC 28602-8308, w-(828) 327-7000 x4145, f-(828) 322-5455, Jodi B Lynch, Lab Technician (1998)

HunterLab, 11491 Sunset Hills Rd, Reston VA 20190-5264, w-(703) 471-6870, f-(703) 471-4237, Harold Good, Dir of Mktng (1993)

INDA Assoc Nonwoven Fabrics, PO Box 1288, Cary NC 27512-1288, w-(919) 233-1210 x115, f-(919) 233-1282, Rory Holmes, Pres (1997)

Industrial Fabrics Assoc Int'l, 1801 County Road B W, Roseville MN 55113-4052, w-(615) 222-2508, f-(615) 631-9334, Stephen M Warner, Pres (1998)

Interface Fabrics - Elkin, PO Box 530, Elkin NC 28621-0530, w-(336) 526-0442, f-(336) 526-0603, Kenneth D Basehore, Lab Mgr (1963)

Intertek Testing Services, Godrej Soaps Complex EE Hwy, Unit No 4 Pirojshanagar, Vikhroli Mumbai 400079 INDIA, w-011912255976901, f-011912225188787, B R Manjunath, General Mgr (2000)

ITNH Inc, 150 Dow St, Manchester NH 03101-1227, w-(603) 669-6900, f-(603) 669-6911, Sasson Shemesh, Pres (2005)

James H Heal & Co Ltd, Richmond Works, Lake View, Halifax HX3 6EP UNITED KINGDOM, w-011441422430671, f-011441422352440, Rachel Bannister (2004)

JC Penney Co, 1625 Crescent Cir Ste 115, Carrollton TX 75006-3655, w-(972) 431-9805, f-(972) 245-1147, Andy Van, Mgr Prod Res & Tech Labs (1944)

Junior Gallery, 463 Fashion Ave Fl 5, New York NY 10018-8724, w-(212) 273-8800, f-(212) 613-6588, Monish Aggarwal, Production Mgr (2002)

Kenyon Industries Inc, PO Box 115, Shannock RI 02875-0115, w-(401) 364-3400, f-(401) 364-6130, Sharon Wilbur, Tech Dir of Dyeing (1944)

Keystone Aniline Corp, 11600 N Community House Rd, Ste 100, Charlotte NC 28277-2159, w-(312) 666-2015, Athur J Andrews, Chairman (1969)

Konica Minolta Photo Imaging USA, 725 Darlington Ave, Mahwah NJ 07430-2601, f-(201) 574-4201, Maria Repici, Mktng Mgr (1993)

Korea Apparel Test & Res Institute, 232-22 Yongdu-Dong Dongdaemun-Gu, Seoul 130 070 SOUTH KOREA, w-0118229252451, f-0118229252462, Chung Seok Yoo, General Dir (1979)

Kusters Corp, PO Box 6128, Spartanburg SC 29304-6128, w-(864) 576-0660, f-(864) 587-5761, Halis Alkis, Pres (1977)

LanXess, 10150 Greenville Hwy, Wellford SC 29385-9528, w-(864) 439-6333 x212, f-(864) 439-1612, R Bradley Potter, Mktng Specialist Tech Text (1947)

Leadertech Colors Inc, 520 Elm St, Kearny NJ 07032-3620, w-(201) 955-2400, f-(201) 955-2822, Isaac Moradi, Pres (2004)

Lectra, 889 Franklin Rd SE, Marietta GA 30067-7945, w-(770) 422-8050, f-(800) 746-5068, Tim Copeland, Dir of Mktng (2004)

Lenmar Chemical Corp, PO Box 571, Dalton GA 30722-0571, w-(706) 277-9505, f-(706) 277-9287, Jim Price, Pres (1999)

Life Sciences Materials Lab, 311 HSW/YAPT, 7980 Lindbergh Lndg Bldg 578, Brooks City-Base TX 78235-5119, w-(210) 925-3355, f-(210) 925-9667, Tony M Hernandez, Chemist (2003)

Lindley Laboratories Inc, PO Box 341, Burlington NC 27216-0341, w-(336) 449-7521, f-(336) 449-0624, J Thomas Lindley Jr, Chief Chemist (1987)

Linmark Group Limited, 20/f Office Tower One, The Harbourfront 18 Tak Fung St, Hunghom Kowloon HONG KONG, w-01185227340827, f-01185223112518, Patrick Fu, Executive Dir (2005)

M Dohmen USA, 25 Ellwood Ct, Greenville SC 29607-5340, w-(864) 676-1669, f-(864) 676-0114, Jim McCall, Pres (2003)

Manchester Metropolitan Univ, Hollings Campus, Dept Clothing Design & Tech, Manchester M14 HR UNITED KINGDOM, w-011441612472656, Angela C Peers, Principal Lecturer (2004)

Manufacturers Chemicals L P, PO Box 2788, Cleveland TN 37320-2788, w-(423) 476-6518, f-(423) 479-7284, Linda Rader, Asst To Pres (2004)

MFG Chemical Inc, 6701 Highway 64 E, Wartrace TN 37183-3056, w-(706) 226-4114, f-(706) 275-6044, Charles E Gavin III, Pres (1993)

Milliken & Co, PO Box 5521, Library M-470, Spartanburg SC 29304-5521, w-(864) 503-2543, f-(864) 503-2769 (1969)

Mitsubishi Specialty Chemicals Inc, 100 Wood Avenue S, Ste 201, Iselin NJ 08830-2716, Donald Wilson, Business Mgr Text Chem (2004)

Morlot Color & Chemical Co, 111 Ethel Ave, Hawthorne NJ 07506-1528, w-(973) 423-0600, f-(973) 423-4096, Ernest Caradori, Pres (1987)

National Cleaners Assn, 252 W 29th St, New York NY 10001-5271, w-(212) 967-3002, f-(212) 967-2240, Alan Spielvogel, Dir of Tech Service (2005)

National Textile Assn, Engineered Solutions PLLC, 110 Hawthorne Ln, Charlottesville VA 22911-8689, w-(617) 542-8220, f-(617) 542-2199, Hardy Poole, Pres (1998)

National Textiles LLC, PO Box 1580, Winston Salem NC 27102-1580, w-(336) 519-7527, f-(336) 519-0210, Steve Brooks, Mgr Dyes/Chem (1998)

NC State University, College of Textiles, PO Box 8301, Raleigh NC 27695-0001, w-(919) 515-6500, f-(919) 515-3057, A Blanton Godfrey, Dean (1952)

NC Textile Mfrs Assn Inc, 5640 Six Forks Rd Ste 201, Raleigh NC 27609-8613, w-(919) 847-4135, f-(919) 847-9856, James M Bell, Pres & General Counsel (1997)

Ned Graphics Inc, 104 W 40th St Fl 12, New York NY 10018-3661, w-(212) 921-2727, f-(212) 768-4488, Geoff Taylor, VP Sales C/m Div (2003)

Novelon Inc, 8309 Wilkinson Blvd, Charlotte NC 28214-9052, w-(704) 391-6353, f-(704) 391-7340, Mark Carlough, Market Dev Mgr NA (2004)

Oakley Inc, 1 Icon, Foothill Ranch CA 92610-3000, w-(949) 829-6461, f-(949) 672-6046, Jamie Oman, R&D Mgr/Eng (2000)

Omnova Solutions Inc, 1476 J A Cochran Byp, Chester SC 29706-2187, w-(803) 385-5181, f-(803) 377-3542, Mark Mussman, Mktng & Sales Mgr (1964)

Organic Dyestuffs Corp, PO Box 14258, East Providence RI 02914-0258, w-(401) 434-3300, f-(401) 438-8136, Gregory M Gormley, Pres (1976)

Orient Craft Ltd, 7D Maruti Ind Complex Sec 18, Udyog Vihar, Gurgaon 122015 INDIA, w-91124342908, f-911246342042, Sudhir Dhingra, Chairman (1999)

Pantone Inc, 590 Commerce Blvd, Carlstadt NJ 07072-3013, w-(201) 935-5500, f-(201) 896-0242, Lisa Herbert, EVP (1988)

Para-Chem Inc, PO Box 127, Simpsonville SC 29681-0127, w-(864) 967-7691 x1324, f-(864) 228-1024, John J Martin, Vice Pres Sales & Mktng (1968)

Parameter Generation & Control Inc, PO Box 129, Black Mountain NC 28711-0129, w-(828) 669-8717, f-(828) 669-6928, Natalie Brem, Sales Asst (2003)

Paramont Impex India, B-3/45 Paschim Viha, New Delhi 110 063 INDIA, w-0119125263808, f-01191115259336, Jatinder Kaur, General Mgr - Expo (1998)

Piedmont Chemical Ind Inc, PO Box 2728, High Point NC 27261-2728, w-(919) 885-5131, Fred E Wilson Jr, Pres (975)

Polo-Ralph Lauren LP, Technicial Center, 4100 Beedwood Dr, Greensboro NC 27410-8112, w-(336) 632-5000, f-(336) 632-9178, Greg Feldman, VP Quality & Product Eng (1995)

Procter & Gamble Co, 5299 Spring Grove Ave, Cincinnati OH 45217-1025, w-(513) 627-7290, f-(513) 627-5536, Nodie M Washington, Associate Dir (1934)

PSP Mktng Inc, PO Box 669145, Charlotte NC 28266-9145, w-(704) 357-1162, f-(704) 357-6161, Peter Philipp, Pres (1996)

Q-Panel Lab Products, 800 Canterbury Rd, Westlake OH 44145-1419, w-(440) 835-8700, f-(440) 835-8738, Eric Everett, Tech Standards Specialist (2001)

R L Stowe Mills Inc, 1101 S Watkins St, Chattanooga TN 37404 4616, w-(423) 493-1000 x3905, f-(423) 493-7489, Jack Callaghan, Div Pres (1938)

R R Street & Co, 184 Shuman Blvd Ste 150, Naperville IL 60563-8459, w-(708) 416-4244, f-(708) 416-4266, Timothy Racette, Vice Pres/R&D (1943)

Riverside Manufacturing Co, PO Box 460, Moultrie GA 31776-0460, w-(912) 985-5210, f-(912) 985-3667, William Jerry Vereen, Pres/CEO (1976)

Roaches International Ltd, Staffordshire, Upperhulme Near Leek, ST13 8TY ENGLAND, w-011441538300425, f-011441538300364, Richard Golonko, Managing Dir (1985)

Rohm & Haas Co, PO Box 904, Spring House PA 19477-0904, w-(215) 641-7783, f-(704) 717-1370, Deirdre Crowley, Mktng Mgr (1926)

Rossari Biotech India P Ltd, 401 Omega Main St, Hiranandani Gardens, Powai Mumbai 400 076 INDIA, w-011912225709200, f-011912225709210, Sunil S Chari (2003)

Russian Union of TC&C, 15 Myasnikskaya Str Office 11, 101000 Moscow RUSSIA, w-01170959238137, f-01170959238111, German E Krichevsky, Pres (1996)

Santex AG, Fliegeneggstrasse 9, Ch 9555 Tobel SWITZERLAND, w-011418256540, f-011418256544, Uwe Sick, Pres Mgr/Sales (2005)

Scholler Inc, 95 James Way Ste 100, Southampton PA 18966-3847, w-(215) 942-0200, f-(215) 942-0255, Jay Patel, VP Tech (1943)

SDC Enterprises Ltd, PO Box 1117, 82 Gratten Rd, Bradford W Yorkshire BD1 2WU UNITED KINGDOM, w-011441274750160, f-011441274750162, Lynne Ramsden, Sales Admin/Mktg Mgr (2003)

SDL Atlas LLC, 1813A Associates Ln, Charlotte NC 28217-2840, w-(704) 329-0911, f-(704) 329-0914, Robert Lattie (1988)

Seydel-Woolley & Co Inc, PO Box 169, Pendergrass GA 30567-0169, w-(404) 693-2266, f-(404) 693-4163, Richard S Adams, Pres (1988)

SGS (Mauritius) Ltd, SGS House, Val-entia, Phoenix MAURITIUS, w-0112306968808, f-0112306967088, Zikriya Bolaky, Textile Lab Mgr (2001)

SGS Hong Kong Ltd, 5-7/F Metropole Centre 2 On Yiu S, Siu Lek Yuen Shatin HONG KONG, w-0118523642272, f-01185223624647, Y M Yuen, Lab Mgr (1987)

SMT Services & Metrologie Textile, Rue De La Plaine, 77310 Saint Fargeau FRANCE, w-33164098143, f-33160654241, Guian Antoine (1998)

Soluol Inc, PO Box 112, West Warwick RI 02893-0112, w-(401) 821-8100, Warren J Simmons, Pres & CEO (1955)

Spectrum Dyed Yarns, PO Box 609, Kings Mountain NC 28086-0609, w-(704) 739-7401, f-(704) 739-7257, Richard Kanipe, Vice Pres Mfg (1984)

Springs Industries (R&D), PO Box 111, Grace Finishing Plant, Lancaster SC 29721-0111, w-(803) 286-2721, f-(803) 286-3489, Pam Jaco, Mgr Prod Dev (1958)

Star-Tec Chemical Inc, PO Box 1286, Elon College NC 27244-1286, w-(336) 229-7448, f-(336) 538-0994, David C Hunsucker (2004)

Stork Prints America Inc, PO Box 26458, Charlotte NC 28221-6458, w-(704) 598-7171, f-(704) 921-5379, Kay Harward, Exe Sec (1994)

Suga Test Instruments Co Ltd, 5-4-14 Shinjuku, Shinjuku-ku, 160 0022 Tokyo JAPAN, w-01181333545248, f-011813333545275, Nagaichi Suga (2004)

Sunbelt Corp, PO Box 2589, Rock Hill SC 29732-4589, w-(803) 417-3973, f-(803) 329-3350, Matt Weinschuetz, Pres (1989)

Suncare Research Labs LLC, 2518B Reynolda Rd, Winston Salem NC 27106-4618, w-(336) 725-6501, f-(336) 725-6503, Joseph W Stanfield, Pres (2003)

T & T Industries Corp, 6th Fl Wan-I-Chen Bldg, 124 Nanking E Rd Sec 2, Taipei R0C TAIWAN, w-886225064107, f-886225060618, Jessica S Yu, Sec To Chairman (1997)

Taiwan Textile Research Institute TTRI, #6 Chengtian Rd Tucheng City, Taipei Hsien ROC TAIWAN, w-011886222670321 x831, f-011886222670720, Chieh Min, Acting Deputy Chief (1980)

Termal Laboratory Equipment, Ipkas 10A Block No 7, Ikitelli, Istanbul 34306 TURKEY, w-011902124879410, f-011902124879420, Murat Ilica, Vice Pres & CEO (2004)

Testfabrics Inc, PO Box 26, West Pittston PA 18643-0026, w-(570) 603-0432, f-(570) 603-0433, W Finley Klaas, Pres (1995)

Tex-South Inc, 509 Fieldgate Ct, Mauldin SC 29662-3309, w-(864) 458-8488, f-(864) 329-0002, Richard R Joye, Pres (2004)

Textile Clothing Technology Corp, 211 Gregson Dr, Cary NC 27511-6495, w-(919) 380-2173, f-(919) 380-2181, Michael T Fralix, Pres (1998)

Textile Innovators Corp, PO Box 8, Windsor NC 27983-0008, w-(252) 794-9703, f-(252) 794-9704, Luther M Myers, Dir (1989)

Textile Institute, 4th Fl St James's Bldgs, Oxford St, Manchester M1 6FQ UNITED KINGDOM, w-441612371188, f-441612361991, Steve Kirkwood, Dir (1999)

Textiles Leon S A De C V, Kappa 107 Frac Ind Delta, 37530 Leon Gto MEXICO, w-01152477761084, f-011524777610804, Roland Alaniz, Dir (2005)

Textiles Rio Lindo S A De C V, Colonia San Jose Del Pedregal, Tegucigalpa 211 HONDURAS, w-(504) 245-5411, f-(504) 245-5433 (2001)

Thailand Textile Institute, Textile Testing Center, 4th Fl Textile Chem & Qual Ctr Bldg, Soi Trimit Rama 4 Rd Phra-kanong, Klong-Toey Bangkok 10110 THAILAND, w-0116627135492 x113, f-0116627135492 x550, Naraporn Rungsimuntakul, Textile Expert (2003)

Tietex International Inc, Technical & Quality Center, PO Box 6218, Spartanburg SC 29304-6218, w-(864) 574-9443, f-(864) 574-9490, Gary Harris, Sr Research Chemist (1989)

Tighe Industries Inc, 333 E 7th Ave, York PA 17404-2144, w-(717) 852-6950, f-(717) 852-6973, John Misner, VP Operations (2005)

Tom Cody Design, 225 West 35th St 9 Fl, New York NY 10001, w-(212) 695-9200, f-(212) 947-3338, Dawn Cody, Vice Pres (2005)

Unilever Home and Personal Care NA, 45 River Rd, Edgewater NJ 07020-1017, w-(201) 943-7100, f-(201) 840-8299, Jack Linard, Sr Group Leader (1933)

United Color Manufacturing Inc, PO Box 480, Newtown PA 18940-0480, w-(215) 860-2165, f-(215) 860-8560, Thomas E Nowakowski, Pres (2004)

United Fabricare Supply Inc, 1237 W Walnut St, Compton CA 90220-5009, w-(310) 537-2096, f-(310) 537-7096, Gilbert Chung, Textile Div Mgr (1999)

United Textile Machinery Corp, PO Box 4100, Fall River MA 02723-0400, w-(508) 676-8247, f-(508) 677-4717, Samuel Shapiro, Pres (1994)

VeriVide Ltd, Quartz Close/Warrens Bus Pk, Enderby Leicester LE19 4SG ENGLAND, w-011441162620228, f-011441162621031, Paul Dakin, Dir (2003)

W E Stephens Manufacturing, PO Box 281287, Nashville TN 37228-8503, w-(615) 255-1278, f-(615) 256-3705, Bruce Hogan, Mgr Laundry Operations (1995)

Wellman Inc, PO Box 2050, Fort Mill SC 29716-2050, w-(803) 835-2130, f-(803) 835-2121, Ed Wilburn (1988)

Werner Mathis USA Inc, PO Box 1626, Concord NC 28026-6002, w-(704) 786-6157, f-(704) 786-6159, Marcel Renn, Vice Pres (1984)

Western Piece Dyers & Finishers, 2845 W 48th Pl, Chicago IL 60632-2012, w-(773) 523-7000, f-(773) 523-9295, George Renaldi III, Pres (1952)

WestPoint Stevens/Grifftex, 1900 Cunningham Dr, Opelika AL 36801-6123, w-(334) 742-2391, f-(334) 742-2368, George Andrews, Dir of Grifftex Chemicals Div (1941)

Williamson Dickie Mfg Co, 509 W Vickery Blvd, Fort Worth TX 76104-1110, w-(817) 810-4408, f-(817) 810-4403, Amy Fox, Q A Tech Support Mgr (2002)

Wolfe Dye & Bleach Works, 25 Ridge Rd, Shoemakersville PA 19555-8916, w-(610) 562-7639, f-(610) 562-4462, Andrew H Wolfe, Pres (1965)

X-Rite Inc, 3100 44th St SW, Grandville MI 49418-2567, w-(616) 257-2164, f-(616) 534-5939, Teresa Van Sprange, Product Mktg Specialist (1994)

Y H Texpert Corp, 2975 Wilshire Blvd, Ste 430, Los Angeles CA 90010-1107, w-(213) 381-5444, f-(213) 381-5445, Richard Han, Vice Pres (2002)

Yates Bleachery Co, PO Box 800, Flintstone GA 30725-0800, w-(706) 820-1531, f-(706) 820-9459, Pierce A Yates, Pres (1963)

Zimmer Machinery Corp, Praca Flor De Linho 44, Centro Commercial De Alphaville, 06453 000 Barueri Sao Paulo, BRAZIL, w-(803) 463-4352, f-(803) 463-4670, Roland Zimmer, Pres (1995)